

Cottam Solar Project

Environmental Statement Appendix 11.4: Geo-Environmental Risk Assessment Cable Corridor Part 2 of 4

Prepared by: Delta Simons
January 2023

PINS reference: EN010133
Document reference: APP/C6.3.11.4
APFP Regulation 5(2)(a)



Lincolnshire

Published 1921 - 1922

Source map scale - 1:10,560

The historical maps shown were reproduced from maps predominantly held at the scale adopted for England, Wales and Scotland in the 1840's. In 1854 the 1:2,500 scale was adopted for mapping urban areas; these maps were used to update the 1:10,560 maps. The published date given therefore is often some years later than the surveyed date. Before 1938, all OS maps were based on the Cassini Projection, with independent surveys of a single county or group of counties, giving rise to significant inaccuracies in outlying areas. In the late 1940's, a Provisional Edition was produced, which updated the 1:10,560 mapping from a number of sources. The maps appear unfinished - with all military camps and other strategic sites removed. These maps were initially overprinted with the National Grid. In 1970, the first 1:10,000 maps were produced using the Transverse Mercator Projection. The revision process continued until recently, with new editions appearing every 10 years or so for urban areas.

Map Name(s) and Date(s)

051NW	1921	1:10,560
051SW	1922	1:10,560

Historical Map - Slice E

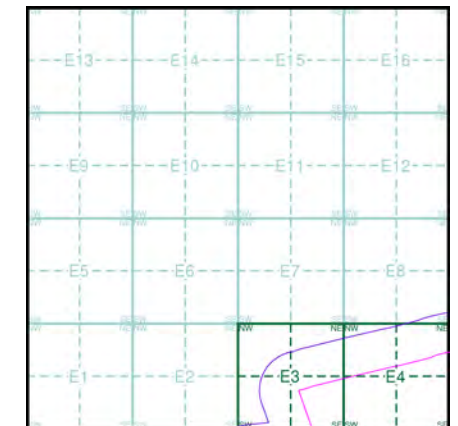

Order Details

Order Number: 297990210_1_1
 Customer Ref: 21-1088.04
 National Grid Reference: 484840, 382170
 Slice: E
 Site Area (Ha): 1120.8
 Search Buffer (m): 250

Site Details

Cottam

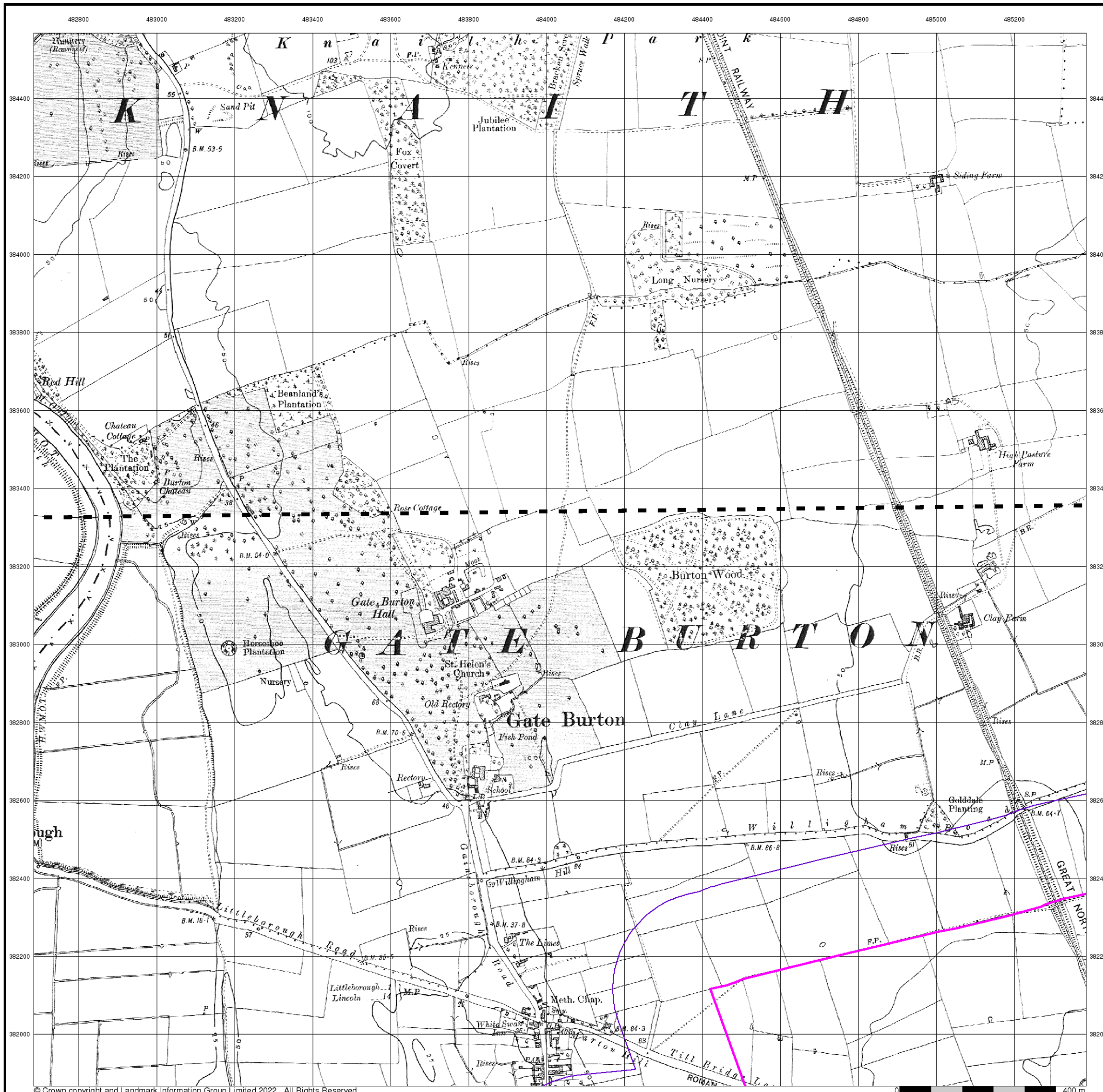

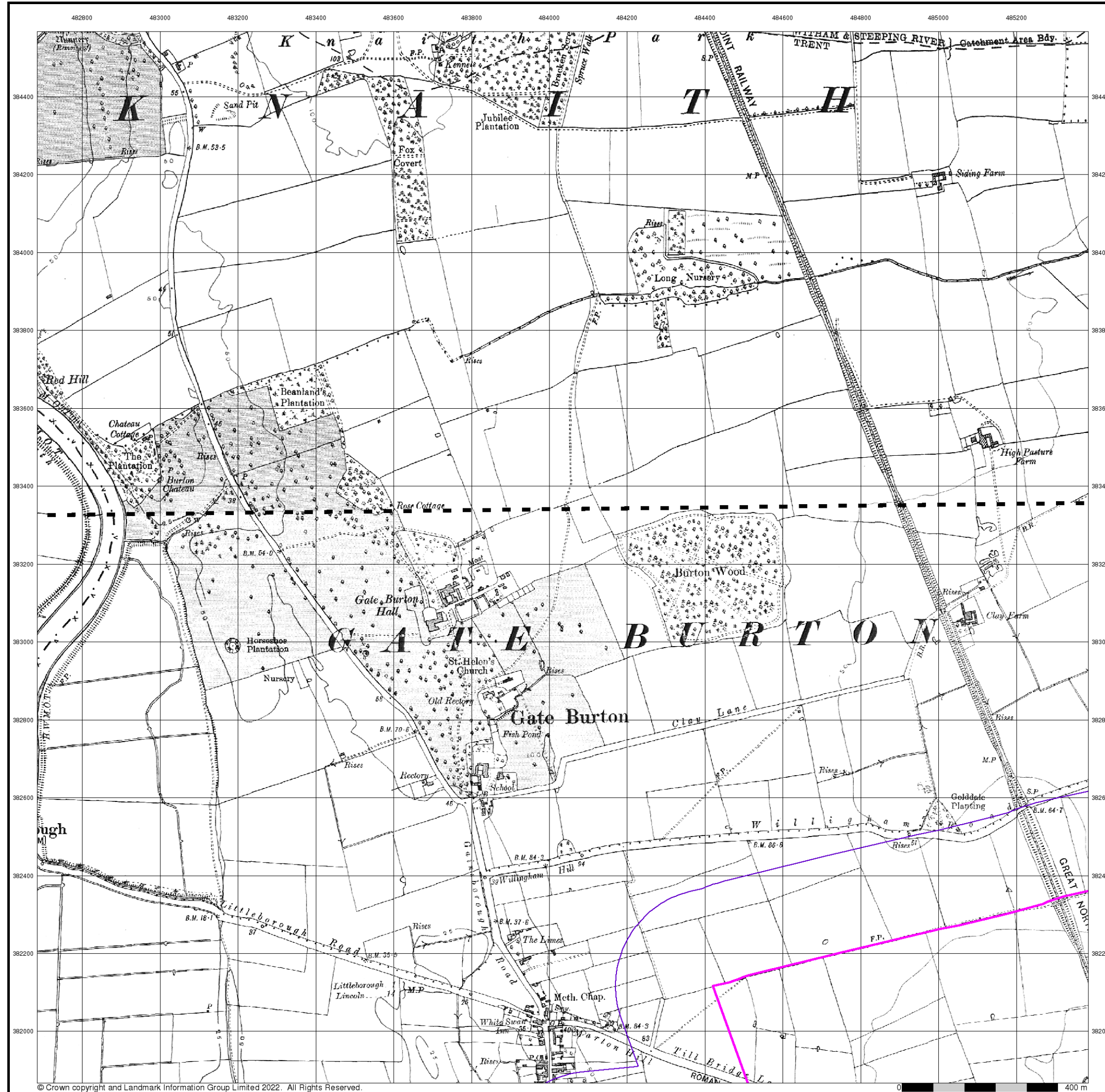

Lincolnshire

Published 1921 - 1922

Source map scale - 1:10,560

The historical maps shown were reproduced from maps predominantly held at the scale adopted for England, Wales and Scotland in the 1840's. In 1854 the 1:2,500 scale was adopted for mapping urban areas; these maps were used to update the 1:10,560 maps. The published date given therefore is often some years later than the surveyed date. Before 1938, all OS maps were based on the Cassini Projection, with independent surveys of a single county or group of counties, giving rise to significant inaccuracies in outlying areas. In the late 1940's, a Provisional Edition was produced, which updated the 1:10,560 mapping from a number of sources. The maps appear unfinished - with all military camps and other strategic sites removed. These maps were initially overprinted with the National Grid. In 1970, the first 1:10,000 maps were produced using the Transverse Mercator Projection. The revision process continued until recently, with new editions appearing every 10 years or so for urban areas.

Map Name(s) and Date(s)

051NW	1921	1:10,560
051SW	1922	1:10,560

Historical Map - Slice E

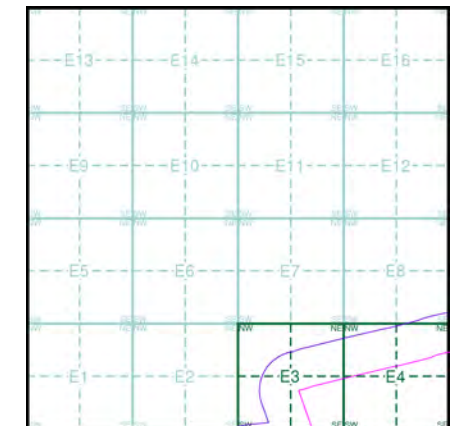

Order Details

Order Number: 297990210_1_1
 Customer Ref: 21-1088.04
 National Grid Reference: 484840, 382170
 Slice: E
 Site Area (Ha): 1120.8
 Search Buffer (m): 250

Site Details

Cottam



Tel: [Redacted]
 Fax: [Redacted]
 Web: [Redacted]

Lincolnshire

Published 1947

Source map scale - 1:10,560

The historical maps shown were reproduced from maps predominantly held at the scale adopted for England, Wales and Scotland in the 1840's. In 1854 the 1:2,500 scale was adopted for mapping urban areas; these maps were used to update the 1:10,560 maps. The published date given therefore is often some years later than the surveyed date. Before 1938, all OS maps were based on the Cassini Projection, with independent surveys of a single county or group of counties, giving rise to significant inaccuracies in outlying areas. In the late 1940's, a Provisional Edition was produced, which updated the 1:10,560 mapping from a number of sources. The maps appear unfinished - with all military camps and other strategic sites removed. These maps were initially overprinted with the National Grid. In 1970, the first 1:10,000 maps were produced using the Transverse Mercator Projection. The revision process continued until recently, with new editions appearing every 10 years or so for urban areas.

Map Name(s) and Date(s)

051NW	1947	1:10,560
051SW	1947	1:10,560

Historical Map - Slice E

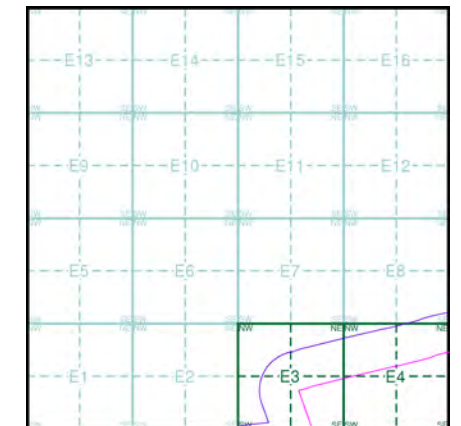

Order Details

Order Number: 297990210_1_1
 Customer Ref: 21-1088.04
 National Grid Reference: 484840, 382170
 Slice: E
 Site Area (Ha): 1120.8
 Search Buffer (m): 250

Site Details

Cottam

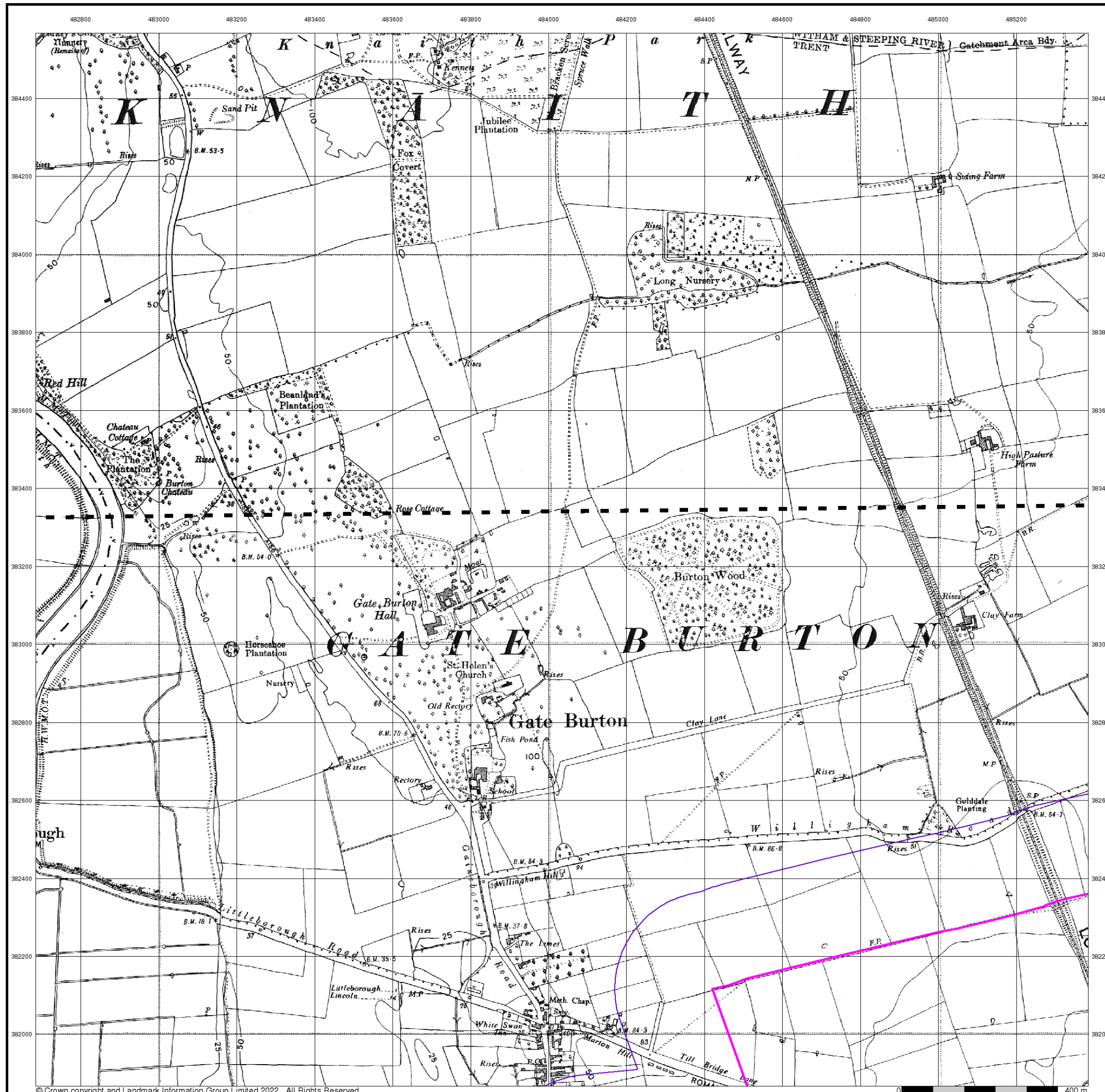

Ordnance Survey Plan

Published 1956

Source map scale - 1:10,000

The historical maps shown were reproduced from maps predominantly held at the scale adopted for England, Wales and Scotland in the 1840's. In 1854 the 1:2,500 scale was adopted for mapping urban areas; these maps were used to update the 1:10,560 maps. The published date given therefore is often some years later than the surveyed date. Before 1938, all OS maps were based on the Cassini Projection, with independent surveys of a single county or group of counties, giving rise to significant inaccuracies in outlying areas. In the late 1940's, a Provisional Edition was produced, which updated the 1:10,560 mapping from a number of sources. The maps appear unfinished - with all military camps and other strategic sites removed. These maps were initially overprinted with the National Grid. In 1970, the first 1:10,000 maps were produced using the Transverse Mercator Projection. The revision process continued until recently, with new editions appearing every 10 years or so for urban areas.

Map Name(s) and Date(s)

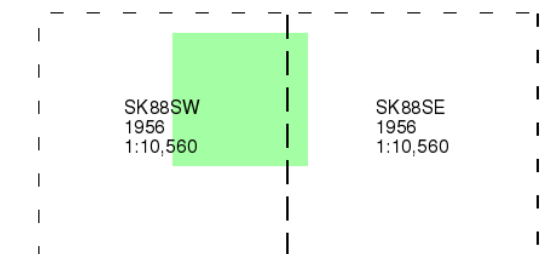

Historical Map - Slice E

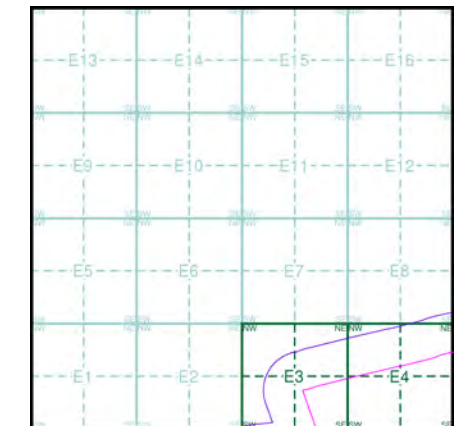

Order Details

Order Number: 297990210_1_1
 Customer Ref: 21-1088.04
 National Grid Reference: 484840, 382170
 Slice: E
 Site Area (Ha): 1120.8
 Search Buffer (m): 250

Site Details

Cottam

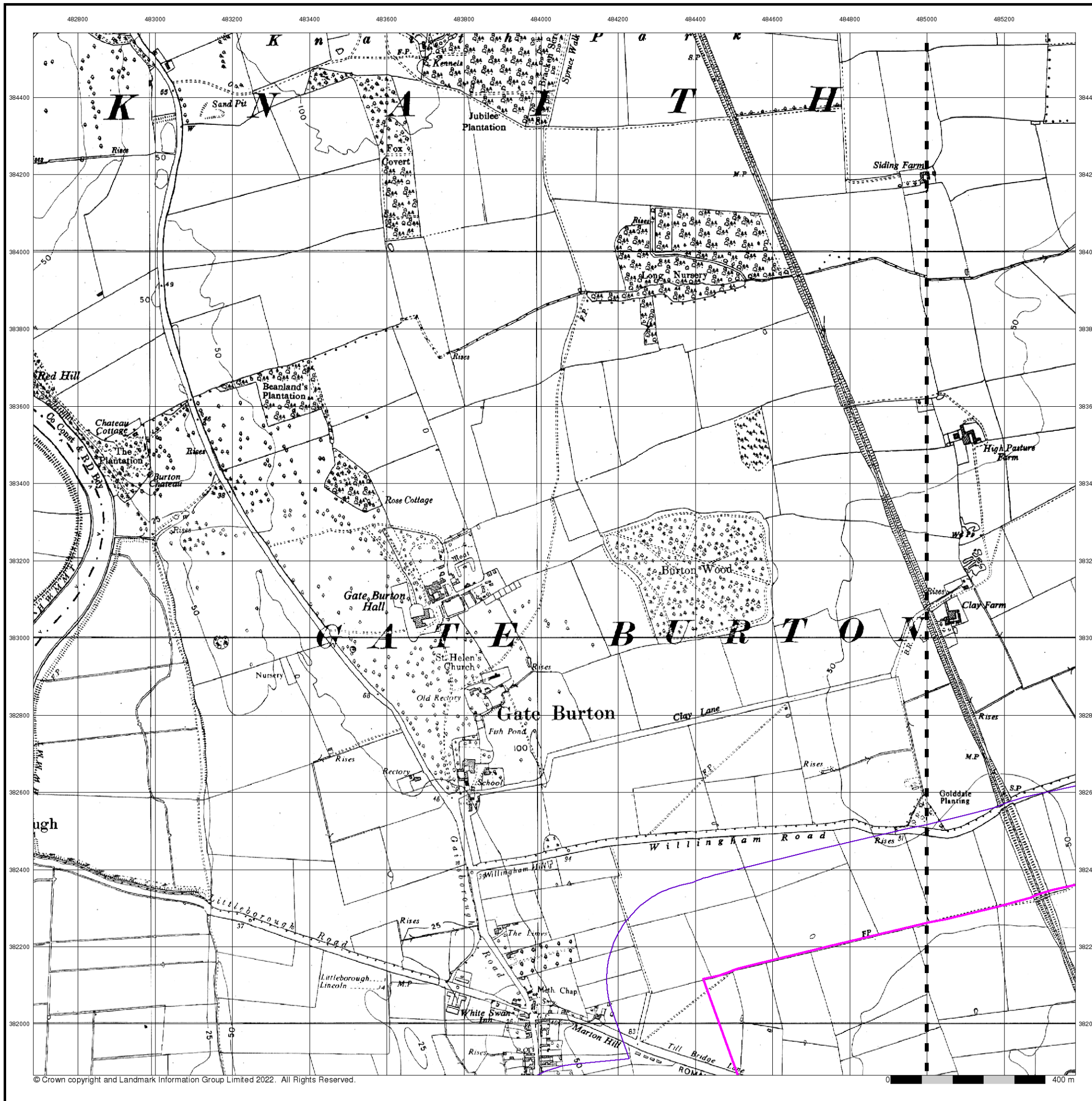

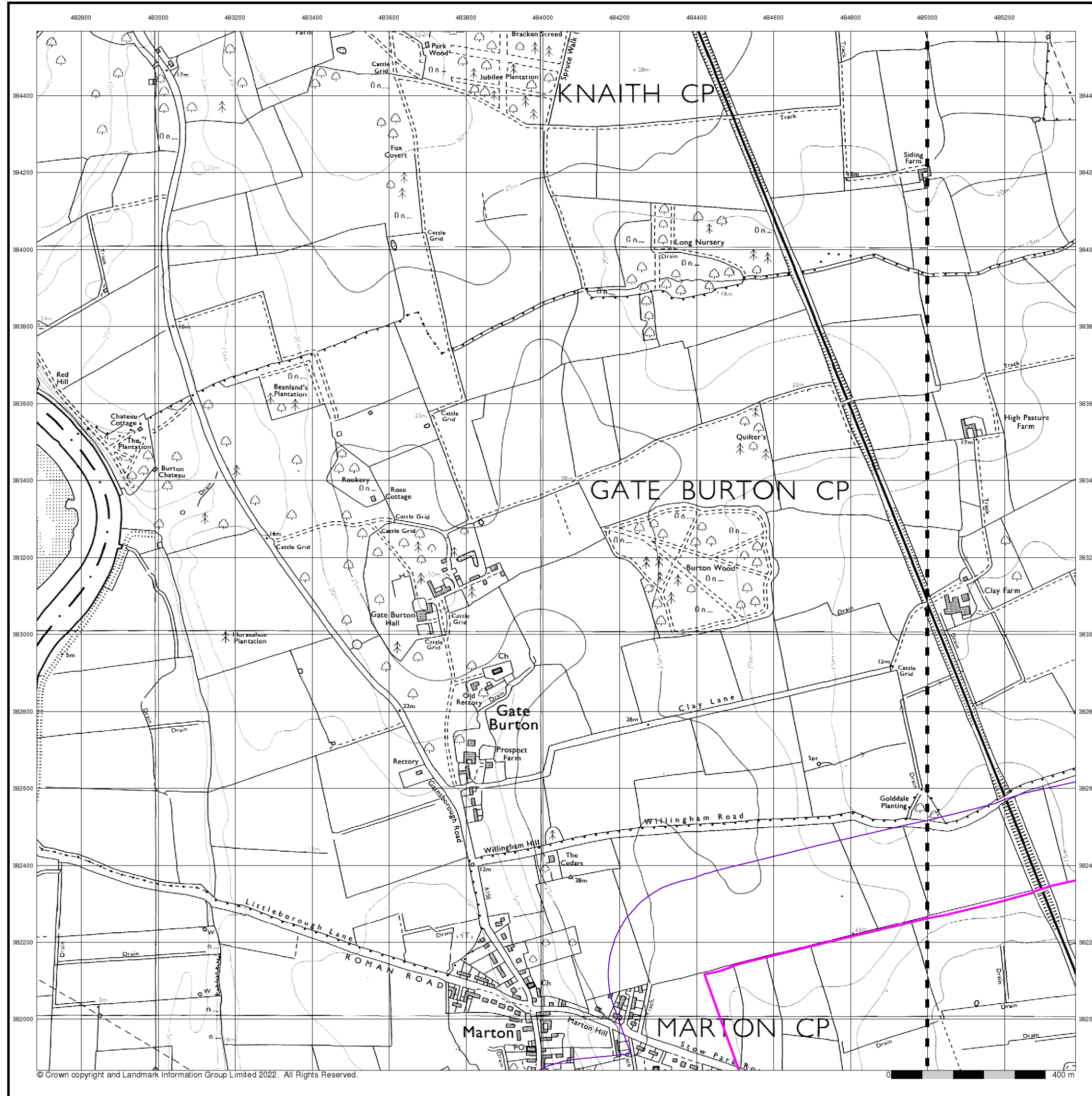

© Crown copyright and Landmark Information Group Limited 2022. All Rights Reserved.

0 400 m



Ordnance Survey Plan
Published 1980 - 1981
Source map scale - 1:10,000

The historical maps shown were reproduced from maps predominantly held at the scale adopted for England, Wales and Scotland in the 1840's. In 1854 the 1:2,500 scale was adopted for mapping urban areas; these maps were used to update the 1:10,560 maps. The published date given therefore is often some years later than the surveyed date. Before 1938, all OS maps were based on the Cassini Projection, with independent surveys of a single county or group of counties, giving rise to significant inaccuracies in outlying areas. In the late 1940's, a Provisional Edition was produced, which updated the 1:10,560 mapping from a number of sources. The maps appear unfinished - with all military camps and other strategic sites removed. These maps were initially overprinted with the National Grid. In 1970, the first 1:10,000 maps were produced using the Transverse Mercator Projection. The revision process continued until recently, with new editions appearing every 10 years or so for urban areas.

Map Name(s) and Date(s)

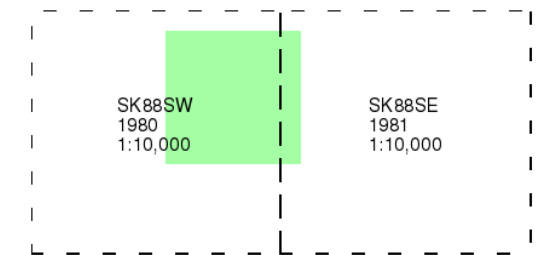

Historical Map - Slice E

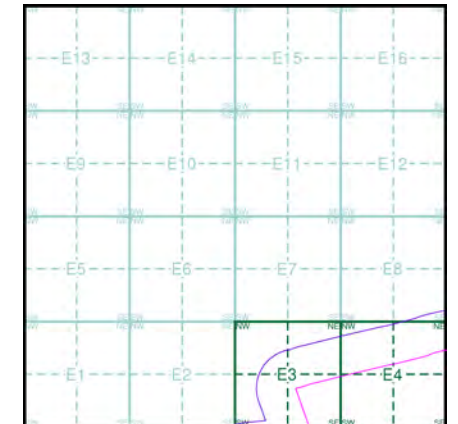

Order Details

Order Number: 297990210_1_1
 Customer Ref: 21-1088.04
 National Grid Reference: 484840, 382170
 Slice: E
 Site Area (Ha): 1120.8
 Search Buffer (m): 250

Site Details

Cottam



Tel: [Redacted]
 Fax: [Redacted]
 Web: [Redacted]

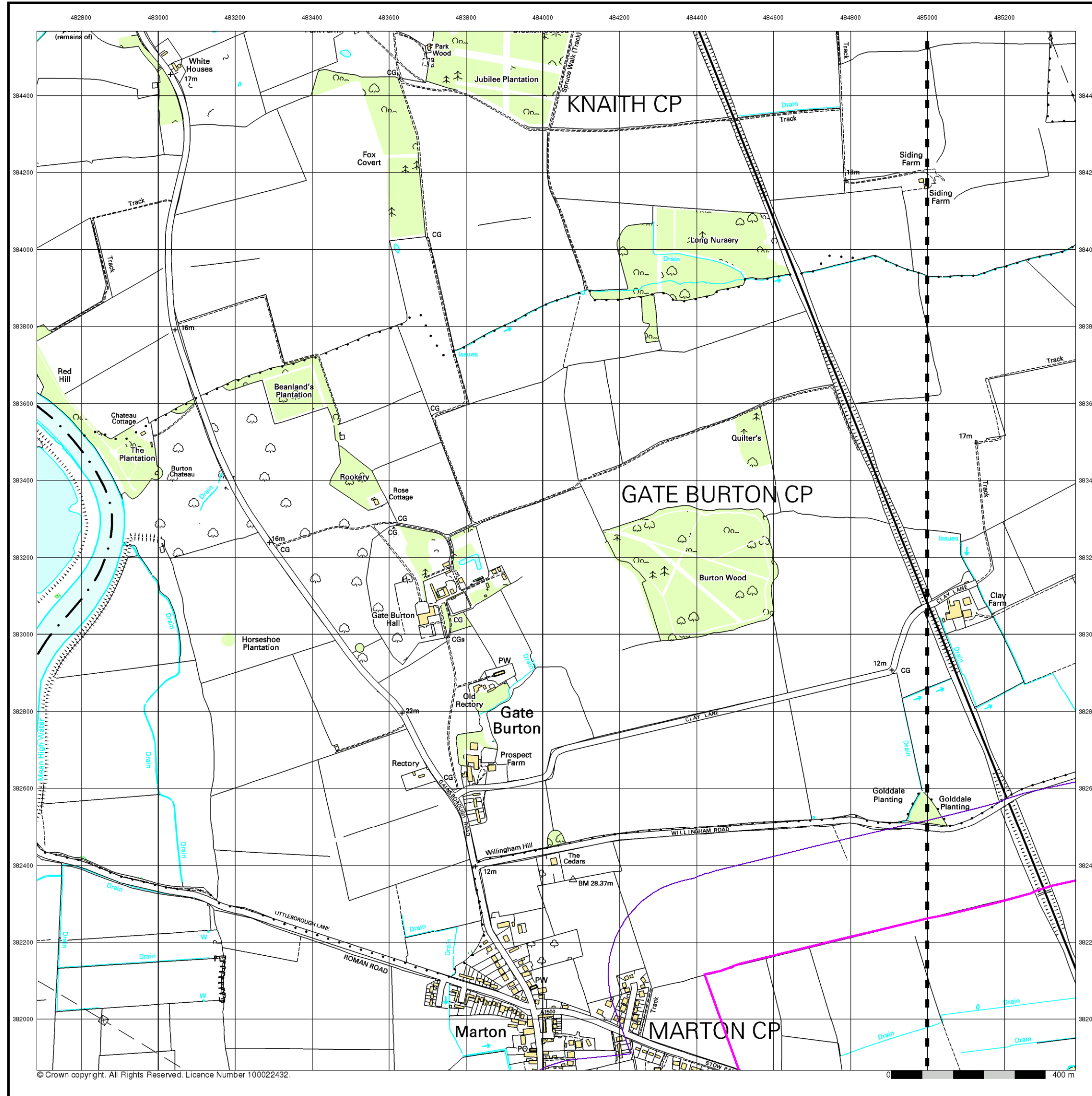

© Crown copyright. All Rights Reserved. Licence Number 100022432.



10k Raster Mapping
Published 2000
Source map scale - 1:10,000

The historical maps shown were produced from the Ordnance Survey's 1:10,000 colour raster mapping. These maps are derived from Landplan which replaced the old 1:10,000 maps originally published in 1970. The data is highly detailed showing buildings, fences and field boundaries as well as all roads, tracks and paths. Road names are also included together with the relevant road number and classification. Boundary information depiction includes county, unitary authority, district, civil parish and constituency.

Map Name(s) and Date(s)

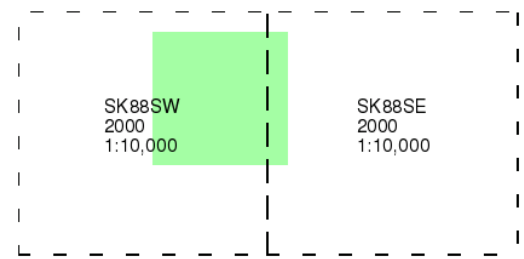

Historical Map - Slice E

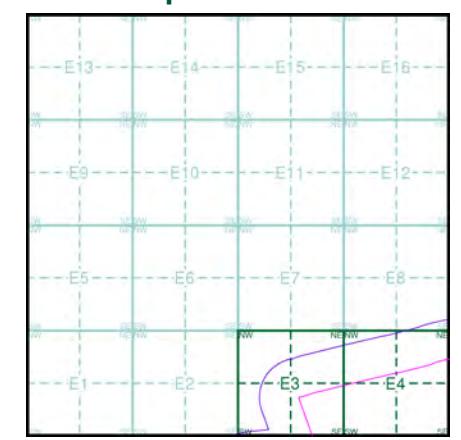

Order Details

Order Number: 297990210_1_1
 Customer Ref: 21-1088.04
 National Grid Reference: 484840, 382170
 Slice: E
 Site Area (Ha): 1120.8
 Search Buffer (m): 250

Site Details

Cottam



Tel: [Redacted]
 Fax: [Redacted]
 Web: [Redacted]

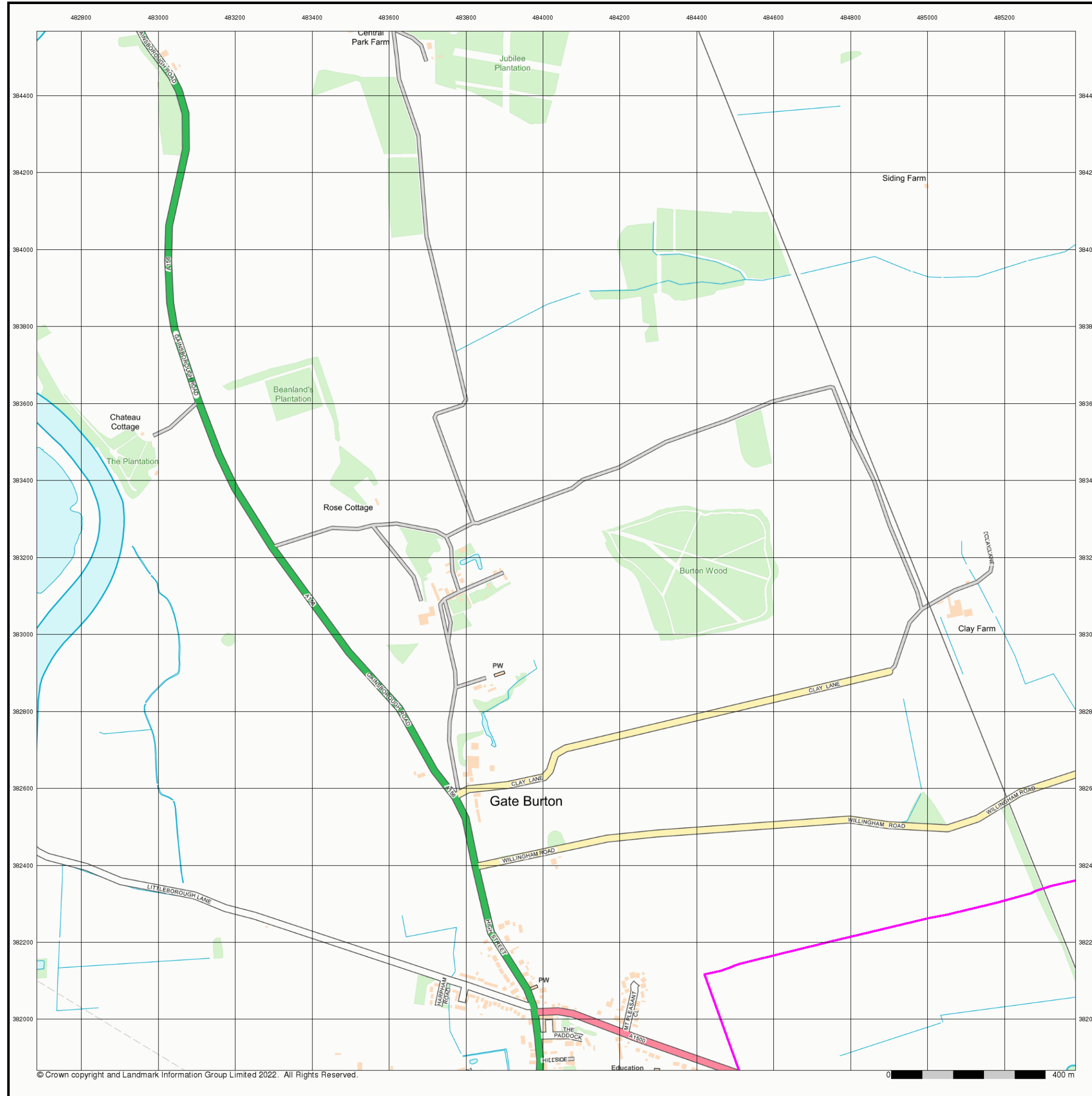

© Crown copyright and Landmark Information Group Limited 2022. All Rights Reserved.

0 400 m



Street View
Published 2022
Source map scale - 1:10,000

Street View is a street-level map for the whole of Great Britain produced by the Ordnance Survey. These maps are provided at a nominal scale of 1:10,000

Map Name(s) and Date(s)

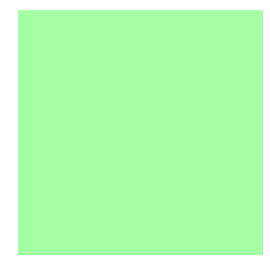

Street View Map - Slice E

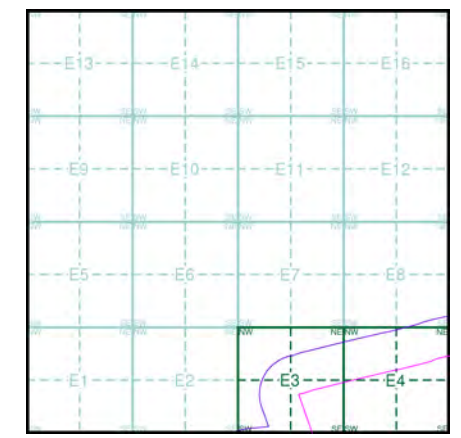

Order Details

Order Number: 297990210_1_1
 Customer Ref: 21-1088.04
 National Grid Reference: 484840, 382170
 Slice: E
 Site Area (Ha): 1120.8
 Search Buffer (m): 250

Site Details

Cottam



Tel: [Redacted]
 Fax: [Redacted]
 Web: [Redacted]

Historical Mapping Legends

Ordnance Survey County Series and Ordnance Survey Plan 1:2,500

Quarry **Gravel Pit** **Sand Pit**
Clay Pit **Shingle** **Refuse Heap**
Sloping Masonry **Flat Rock**
Marsh **Reeds** **Osiers**
Rough Pasture **Furze** **Wood**
Mixed Wood **Brushwood** **Orchard**
Fir **Ford** **Stepping Stones**
Ferry **Waterfall** **Lock**
Trig. Station **Altitude at Trig. Station**
B.M. 325.9 **Bench Mark** **Surface Level**
Arrow denotes flow of water **Antiquities (site of)**
Cutting **Embankment**
Railway crossing Road **Level Crossing** **Road crossing Railway**
Railway crossing River or Canal **Road over single stream** **Road over River or Canal**
County Boundary (Geographical)
County & Civil Parish Boundary
Administrative County & Civil Parish Boundary
County Borough Boundary (England)
Co. Boro. Bdy.
County Burgh Boundary (Scotland)
Co. Burgh Bdy.
B.P. B.S. Boundary Post or Stone **P.C.B.** Police Call Box
B.R. Bridle Road **P.** Pump
E.P. Electricity Pylon **S.P.** Signal Post
F.B. Foot Bridge **Sl.** Sluice
F.P. Foot Path **Sp.** Spring
G.P. Guide Post or Board **T.C.B.** Telephone Call Box
M.S. Mile Stone **Tr.** Trough
M.P. M.R. Mooring Post or Ring **W.** Well

Ordnance Survey Plan, Additional SIMs and Supply of Unpublished Survey Information 1:2,500 and 1:1,250

Inactive Quarry, Chalk Pit or Clay Pit **Active Quarry, Chalk Pit or Clay Pit**
Rock **Boulders**
Cliff **Slopes** **Top**
Roofed Building **Glazed Roof Building**
Sloping Masonry **Archway**
Non-Coniferous Tree (surveyed) **Coniferous Tree (surveyed)**
Non-Coniferous Trees (not surveyed) **Coniferous Trees (not surveyed)**
Orchard Tree **Scrub** **Bracken**
Coppice, Osier **Reeds** **Marsh, Saltings**
Rough Grassland **Heath** **Culvert**
Direction of water flow **Bench Mark** **Antiquity (site of)**
Cave Entrance **Triangulation Station** **Electricity Pylon**
Electricity Transmission Line
County Boundary (Geographical)
County & Civil Parish Boundary
Civil Parish Boundary
Admin. County or County Bor. Boundary
London Borough Boundary
Symbol marking point where boundary mereing changes
BH Beer House **P** Pillar, Pole or Post
BP, BS Boundary Post or Stone **PO** Post Office
Cn, C Capstan, Crane **PC** Public Convenience
Chy Chimney **PH** Public House
D Fn Drinking Fountain **Pp** Pump
EI P Electricity Pillar or Post **SB, S Br** Signal Box or Bridge
FAP Fire Alarm Pillar **SP, SL** Signal Post or Light
FB Foot Bridge **Spr** Spring
GP Guide Post **Tk** Tank or Track
H Hydrant or Hydraulic **TCB** Telephone Call Box
LC Level Crossing **TCP** Telephone Call Post
MH Manhole **Tr** Trough
MP Mile Post or Mooring Post **Wr Pt, Wr T** Water Point, Water Tap
MS Mile Stone **W** Well
NTL Normal Tidal Limit **Wd Pp** Wind Pump

Large-Scale National Grid Data 1:2,500 and 1:1,250

Cliff **Slopes** **Top**
Rock **Rock (scattered)**
Boulders **Boulders (scattered)**
Positioned Boulder **Scree**
Non-Coniferous Tree (surveyed) **Coniferous Tree (surveyed)**
Non-Coniferous Trees (not surveyed) **Coniferous Trees (not surveyed)**
Orchard Tree **Scrub** **Bracken**
Coppice, Osier **Reeds** **Marsh, Saltings**
Rough Grassland **Heath** **Culvert**
Direction of water flow **Triangulation Station** **Antiquity (site of)**
Electricity Transmission Line **Electricity Pylon**
B.M. 231.60m Bench Mark **Buildings with Building Seed**
Roofed Building **Glazed Roof Building**
Civil parish/community boundary
District boundary
County boundary
Boundary post/stone
Boundary mereing symbol (note: these always appear in opposed pairs or groups of three)
Bks Barracks **P** Pillar, Pole or Post
Bty Battery **PO** Post Office
Cemy Cemetery **PC** Public Convenience
Chy Chimney **Pp** Pump
Cis Cistern **Ppg Sta** Pumping Station
Dismtd Rly Dismantled Railway **PW** Place of Worship
EI Gen Sta Electricity Generating Station **Sewage Ppg Sta** Sewage Pumping Station
EI P Electricity Pole, Pillar **SB, S Br** Signal Box or Bridge
EI Sub Sta Electricity Sub Station **SP, SL** Signal Post or Light
FB Filter Bed **Spr** Spring
Fn / D Fn Fountain / Drinking Ftn. **Tk** Tank or Track
Gas Gov Gas Valve Compound **Tr** Trough
GVC Gas Governor **Wd Pp** Wind Pump
GP Guide Post **Wr Pt, Wr T** Water Point, Water Tap
MH Manhole **Wks** Works (building or area)
MP, MS Mile Post or Mile Stone **W** Well



Historical Mapping & Photography included:

Mapping Type	Scale	Date	Pg
Lincolnshire	1:2,500	1886	2
Nottinghamshire	1:2,500	1899	3
Lincolnshire	1:2,500	1920	4
Ordnance Survey Plan	1:2,500	1974 - 1975	5
Additional SIMs	1:2,500	1993	6
Large-Scale National Grid Data	1:2,500	1994	7

Historical Map - Segment E3

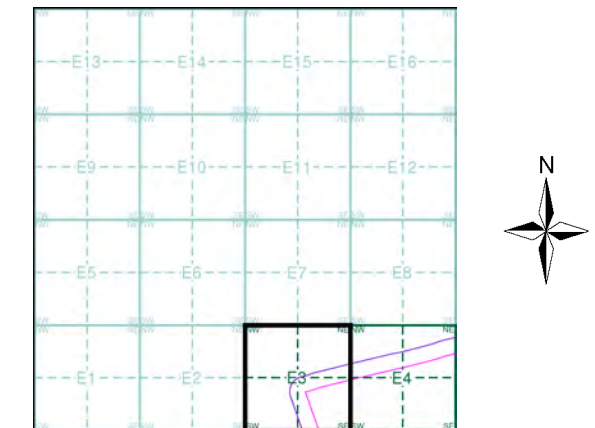

Order Details

Order Number: 297990210_1_1
 Customer Ref: 21-1088.04
 National Grid Reference: 484840, 382170
 Slice: E
 Site Area (Ha): 1120.8
 Search Buffer (m): 100

Site Details

Cottam



Tel: [Redacted]
 Fax: [Redacted]
 Web: [Redacted]

Lincolnshire
Published 1886

Source map scale - 1:2,500

The historical maps shown were reproduced from maps predominantly held at the scale adopted for England, Wales and Scotland in the 1840's. In 1854 the 1:2,500 scale was adopted for mapping urban areas and by 1896 it covered the whole of what were considered to be the cultivated parts of Great Britain. The published date given below is often some years later than the surveyed date. Before 1938, all OS maps were based on the Cassini Projection, with independent surveys of a single county or group of counties, giving rise to significant inaccuracies in outlying areas.

Map Name(s) and Date(s)

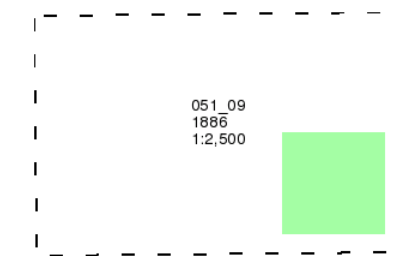

Historical Map - Segment E3

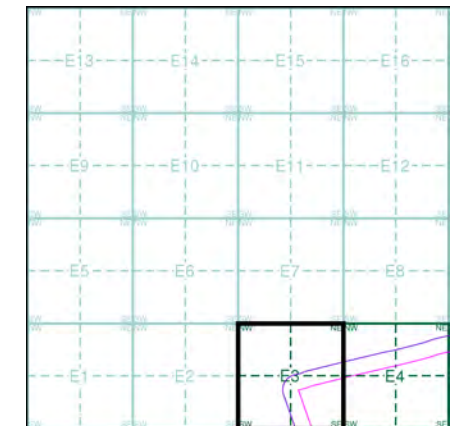

Order Details

Order Number: 297990210_1_1
 Customer Ref: 21-1088.04
 National Grid Reference: 484840, 382170
 Slice: E
 Site Area (Ha): 1120.8
 Search Buffer (m): 100

Site Details

Cottam

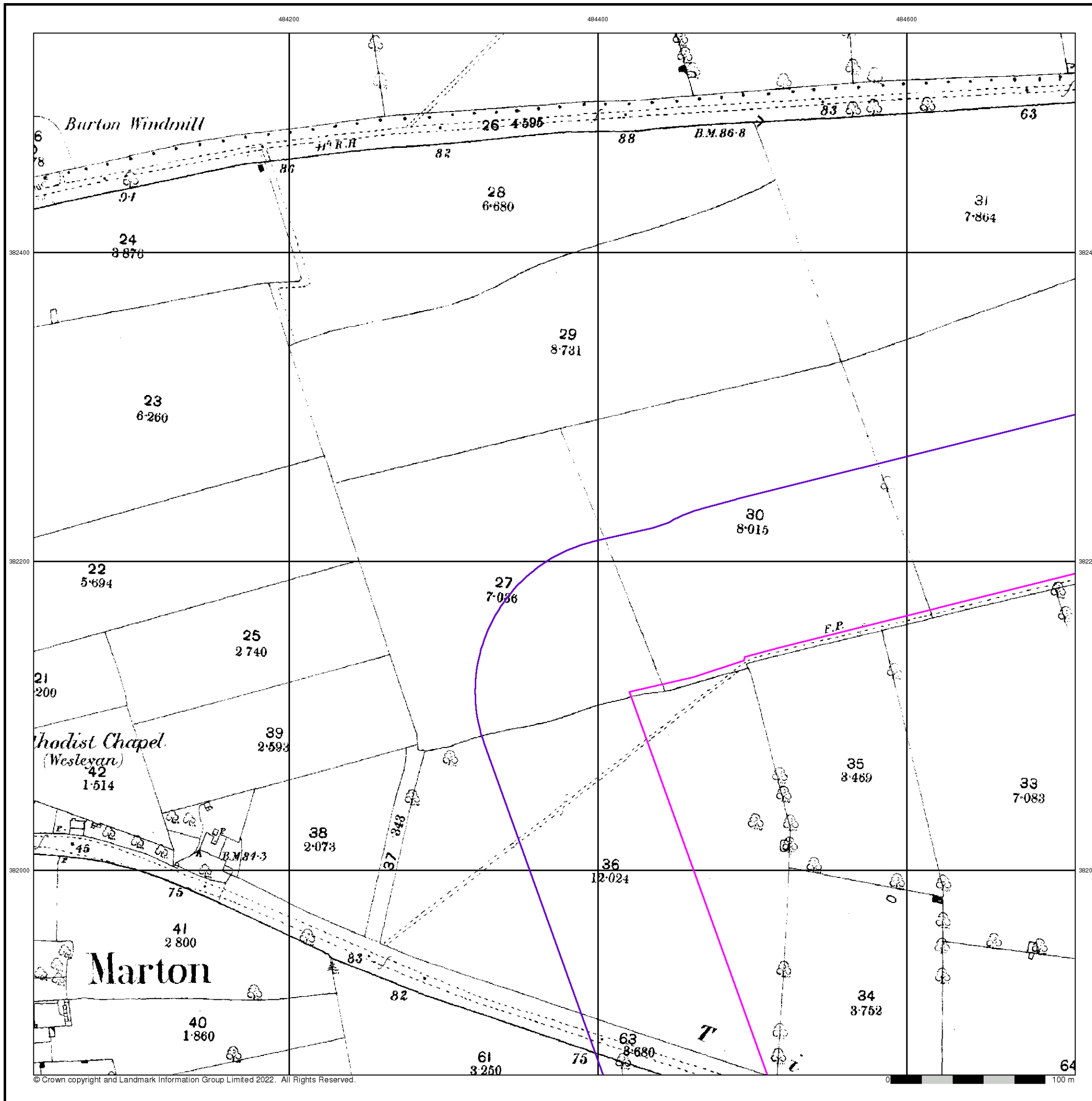

Nottinghamshire

Published 1899

Source map scale - 1:2,500

The historical maps shown were reproduced from maps predominantly held at the scale adopted for England, Wales and Scotland in the 1840's. In 1854 the 1:2,500 scale was adopted for mapping urban areas and by 1896 it covered the whole of what were considered to be the cultivated parts of Great Britain. The published date given below is often some years later than the surveyed date. Before 1938, all OS maps were based on the Cassini Projection, with independent surveys of a single county or group of counties, giving rise to significant inaccuracies in outlying areas.

Map Name(s) and Date(s)

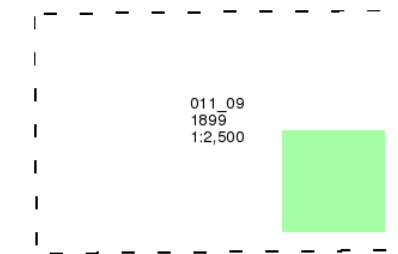

Historical Map - Segment E3

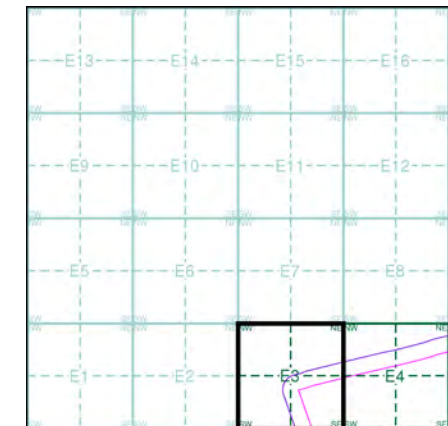

Order Details

Order Number: 297990210_1_1
 Customer Ref: 21-1088.04
 National Grid Reference: 484840, 382170
 Slice: E
 Site Area (Ha): 1120.8
 Search Buffer (m): 100

Site Details

Cottam

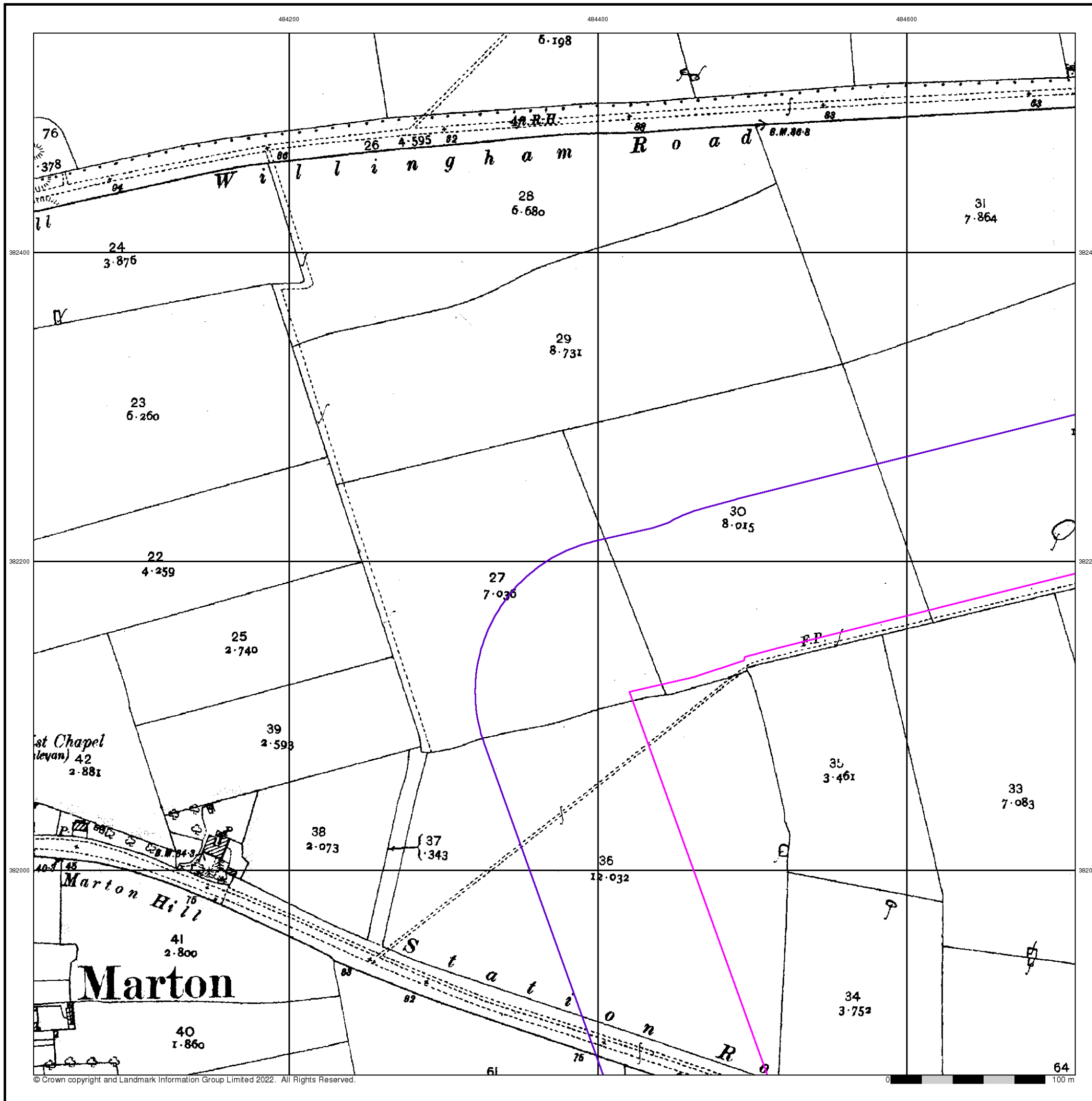

Lincolnshire

Published 1920

Source map scale - 1:2,500

The historical maps shown were reproduced from maps predominantly held at the scale adopted for England, Wales and Scotland in the 1840's. In 1854 the 1:2,500 scale was adopted for mapping urban areas and by 1896 it covered the whole of what were considered to be the cultivated parts of Great Britain. The published date given below is often some years later than the surveyed date. Before 1938, all OS maps were based on the Cassini Projection, with independent surveys of a single county or group of counties, giving rise to significant inaccuracies in outlying areas.

Map Name(s) and Date(s)

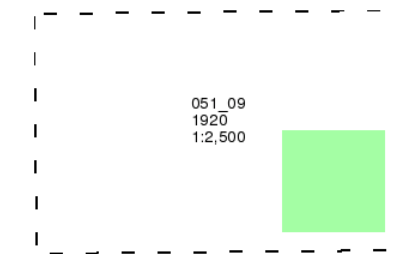

Historical Map - Segment E3

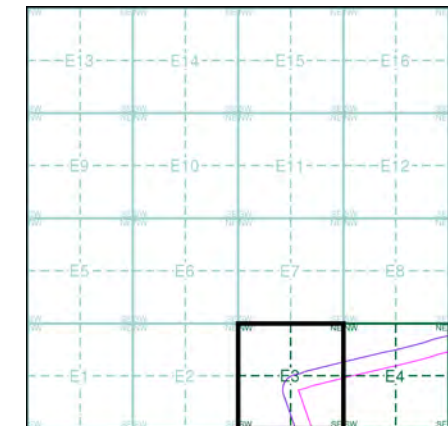

Order Details

Order Number: 297990210_1_1
 Customer Ref: 21-1088.04
 National Grid Reference: 484840, 382170
 Slice: E
 Site Area (Ha): 1120.8
 Search Buffer (m): 100

Site Details

Cottam

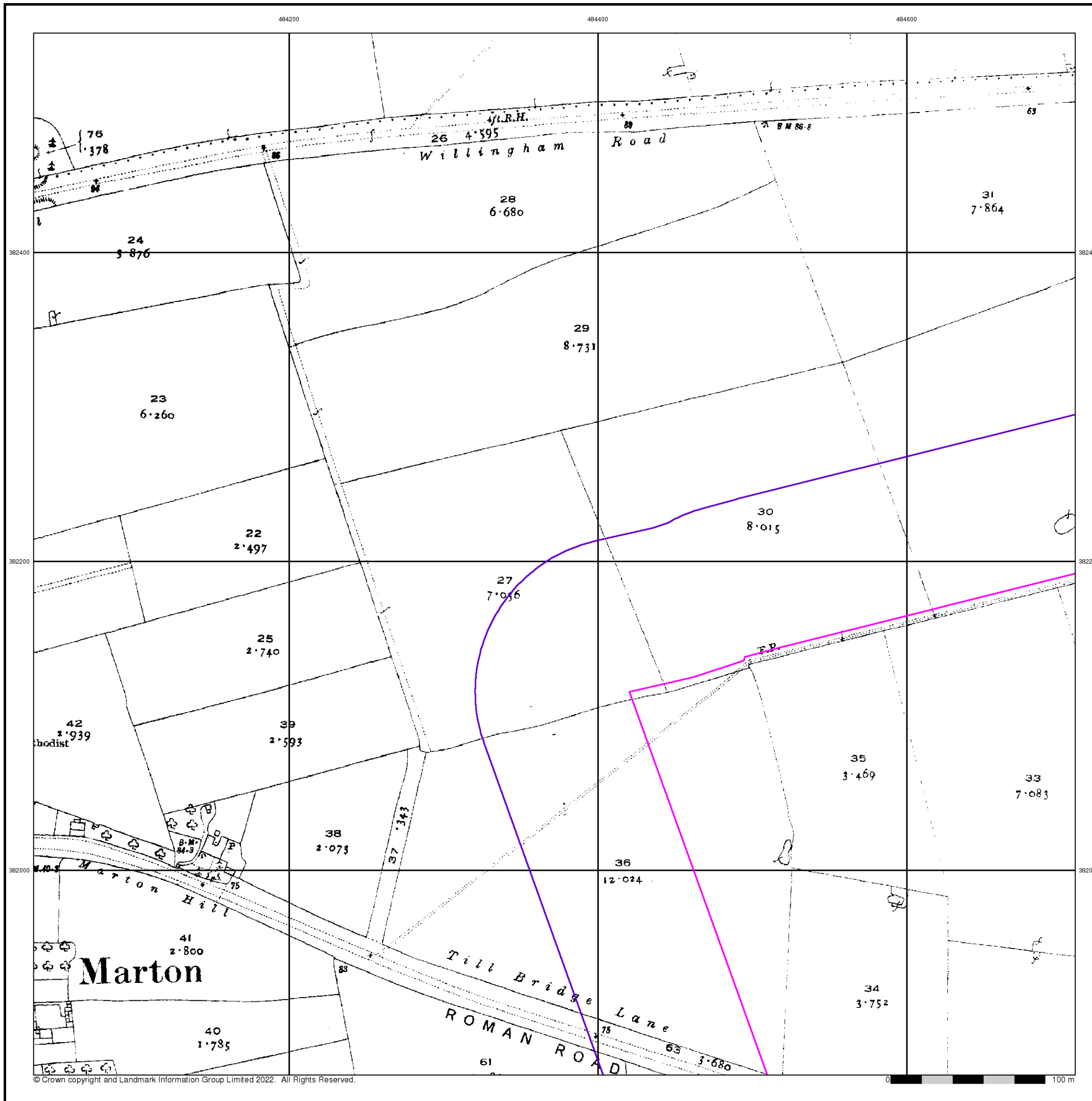

Additional SIMs

Published 1993

Source map scale - 1:2,500

The SIM cards (Ordnance Survey's 'Survey of Information on Microfilm') are further, minor editions of mapping which were produced and published in between the main editions as an area was updated. They date from 1947 to 1994, and contain detailed information on buildings, roads and land-use. These maps were produced at both 1:2,500 and 1:1,250 scales.

Map Name(s) and Date(s)

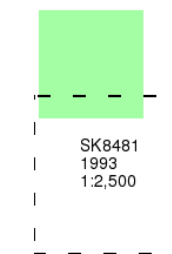

Historical Map - Segment E3

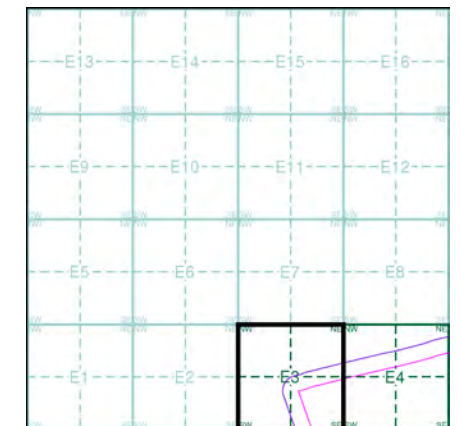

Order Details

Order Number: 297990210_1_1
 Customer Ref: 21-1088.04
 National Grid Reference: 484840, 382170
 Slice: E
 Site Area (Ha): 1120.8
 Search Buffer (m): 100

Site Details

Cottam

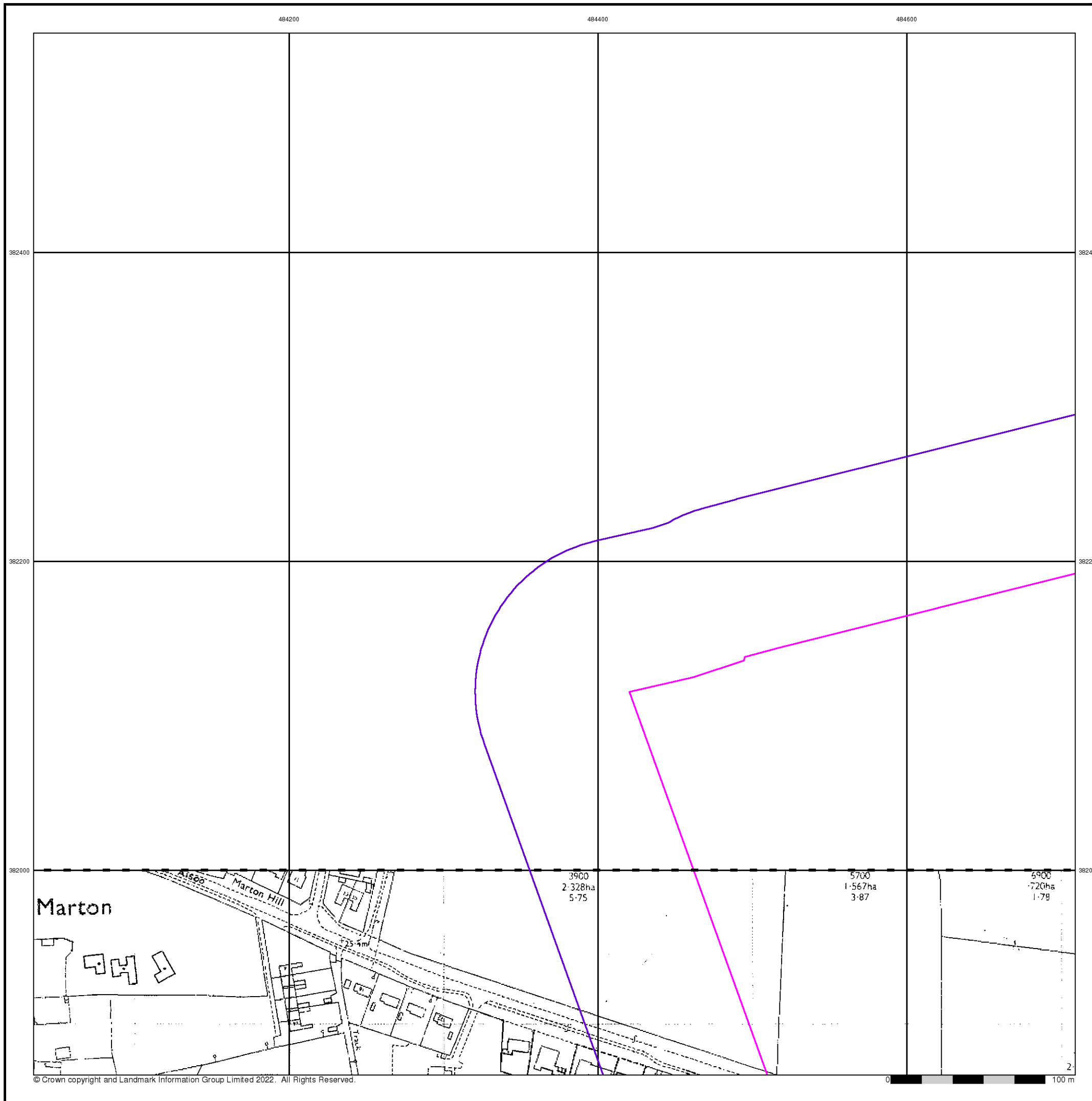

Large-Scale National Grid Data

Published 1994

Source map scale - 1:2,500

'Large Scale National Grid Data' superseded SIM cards (Ordnance Survey's 'Survey of Information on Microfilm') in 1992, and continued to be produced until 1999. These maps were the fore-runners of digital mapping and so provide detailed information on houses and roads, but tend to show less topographic features such as vegetation. These maps were produced at both 1:2,500 and 1:1,250 scales.

Map Name(s) and Date(s)

SK8482	1994	1:2,500
SK8481	1994	1:2,500

Historical Map - Segment E3

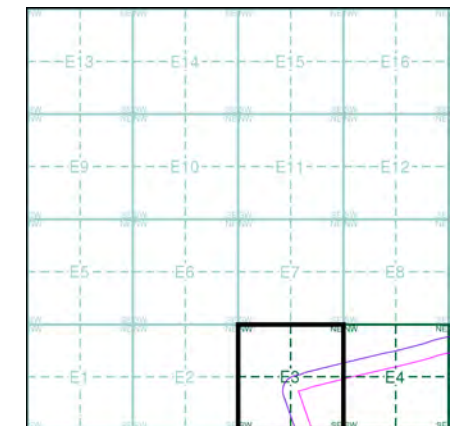

Order Details

Order Number: 297990210_1_1
 Customer Ref: 21-1088.04
 National Grid Reference: 484840, 382170
 Slice: E
 Site Area (Ha): 1120.8
 Search Buffer (m): 100

Site Details

Cottam

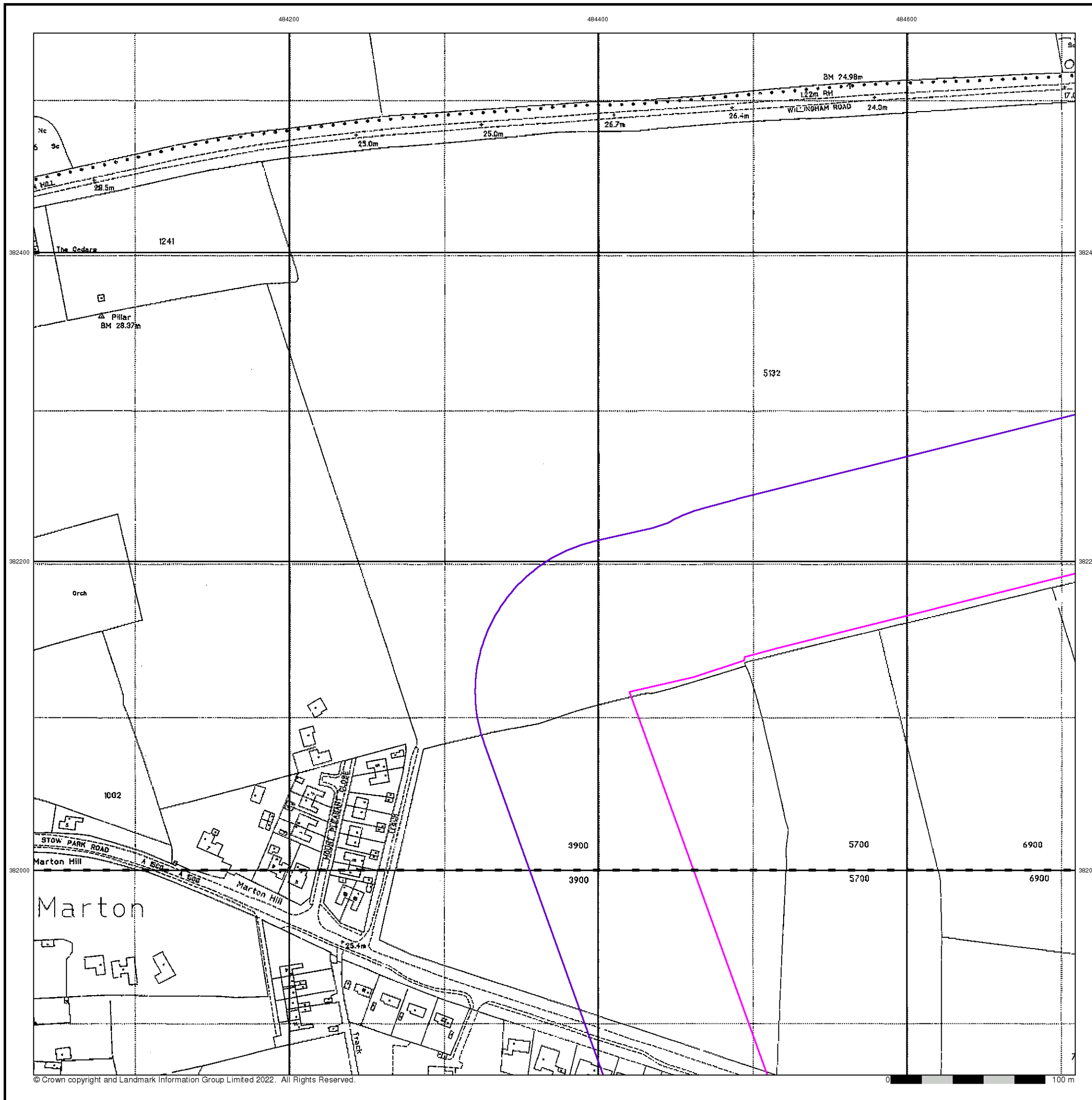

Historical Mapping Legends

Ordnance Survey County Series and Ordnance Survey Plan 1:2,500

Quarry **Gravel Pit** **Sand Pit**
Clay Pit **Shingle** **Refuse Heap**
Sloping Masonry **Flat Rock**
Marsh **Reeds** **Osiers**
Rough Pasture **Furze** **Wood**
Mixed Wood **Brushwood** **Orchard**
Fir **Ford** **Stepping Stones**
Ferry **Waterfall** **Lock**
Trig. Station **Altitude at Trig. Station**
B.M. 325.9 **Bench Mark** **Surface Level**
Arrow denotes flow of water **Antiquities (site of)**
Cutting **Embankment**
Railway crossing Road **Level Crossing** **Road crossing Railway**
Railway crossing River or Canal **Road over single stream** **Road over River or Canal**
County Boundary (Geographical)
County & Civil Parish Boundary
Administrative County & Civil Parish Boundary
County Borough Boundary (England)
Co. Boro. Bdy.
County Burgh Boundary (Scotland)
Boundary Post or Stone **Police Call Box**
B.R. Bridle Road **P. Pump**
E.P. Electricity Pylon **S.P. Signal Post**
F.B. Foot Bridge **Sl. Sluice**
F.P. Foot Path **Sp. Spring**
G.P. Guide Post or Board **T.C.B. Telephone Call Box**
M.S. Mile Stone **Tr. Trough**
M.P. M.R. Mooring Post or Ring **W. Well**

Ordnance Survey Plan, Additional SIMs and Supply of Unpublished Survey Information 1:2,500 and 1:1,250

Inactive Quarry, Chalk Pit or Clay Pit **Active Quarry, Chalk Pit or Clay Pit**
Rock **Boulders**
Cliff **Slopes** **Top**
Roofed Building **Glazed Roof Building**
Sloping Masonry **Archway**
Non-Coniferous Tree (surveyed) **Coniferous Tree (surveyed)**
Non-Coniferous Trees (not surveyed) **Coniferous Trees (not surveyed)**
Orchard Tree **Scrub** **Bracken**
Coppice, Osier **Reeds** **Marsh, Saltings**
Rough Grassland **Heath** **Culvert**
Direction of water flow **Bench Mark** **Antiquity (site of)**
Cave Entrance **Triangulation Station** **Electricity Pylon**
Electricity Transmission Line
County Boundary (Geographical)
County & Civil Parish Boundary
Civil Parish Boundary
Admin. County or County Bor. Boundary
London Borough Boundary
Symbol marking point where boundary mereing changes
BH Beer House **P. Pillar, Pole or Post**
BP, BS Boundary Post or Stone **PO Post Office**
Cn, C Capstan, Crane **PC Public Convenience**
Chy Chimney **PH Public House**
D Fn Drinking Fountain **Pp Pump**
EI P Electricity Pillar or Post **SB, S Br Signal Box or Bridge**
FAP Fire Alarm Pillar **SP, SL Signal Post or Light**
FB Foot Bridge **Spr Spring**
GP Guide Post **Tk Tank or Track**
H Hydrant or Hydraulic **TCB Telephone Call Box**
LC Level Crossing **TCP Telephone Call Post**
MH Manhole **Tr Trough**
MP Mile Post or Mooring Post **Wr Pt, Wr T Water Point, Water Tap**
MS Mile Stone **W Well**
NTL Normal Tidal Limit **Wd Pp Wind Pump**

Large-Scale National Grid Data 1:2,500 and 1:1,250

Cliff **Slopes** **Top**
Rock **Rock (scattered)**
Boulders **Boulders (scattered)**
Positioned Boulder **Scree**
Non-Coniferous Tree (surveyed) **Coniferous Tree (surveyed)**
Non-Coniferous Trees (not surveyed) **Coniferous Trees (not surveyed)**
Orchard Tree **Scrub** **Bracken**
Coppice, Osier **Reeds** **Marsh, Saltings**
Rough Grassland **Heath** **Culvert**
Direction of water flow **Triangulation Station** **Antiquity (site of)**
Electricity Transmission Line **Electricity Pylon**
B.M. 231.60m Bench Mark **Buildings with Building Seed**
Roofed Building **Glazed Roof Building**
Civil parish/community boundary
District boundary
County boundary
Boundary post/stone
Boundary mereing symbol (note: these always appear in opposed pairs or groups of three)
Bks Barracks **P. Pillar, Pole or Post**
Bty Battery **PO Post Office**
Cemy Cemetery **PC Public Convenience**
Chy Chimney **Pp Pump**
Cis Cistern **Ppg Sta Pumping Station**
Dismtd Rly Dismantled Railway **PW Place of Worship**
EI Gen Sta Electricity Generating Station **Sewage Ppg Sta Sewage Pumping Station**
EI P Electricity Pole, Pillar **SB, S Br Signal Box or Bridge**
EI Sub Sta Electricity Sub Station **SP, SL Signal Post or Light**
FB Filter Bed **Spr Spring**
Fn / D Fn Fountain / Drinking Ftn. **Tk Tank or Track**
Gas Gov Gas Valve Compound **Tr Trough**
GVC Gas Governor **Wd Pp Wind Pump**
GP Guide Post **Wr Pt, Wr T Water Point, Water Tap**
MH Manhole **Wks Works (building or area)**
MP, MS Mile Post or Mile Stone **W Well**



Historical Mapping & Photography included:

Mapping Type	Scale	Date	Pg
Lincolnshire	1:2,500	1886	2
Nottinghamshire	1:2,500	1899	3
Lincolnshire	1:2,500	1906	4
Lincolnshire	1:2,500	1920	5
Ordnance Survey Plan	1:2,500	1974 - 1975	6
Additional SIMs	1:2,500	1993	7
Large-Scale National Grid Data	1:2,500	1994	8

Historical Map - Segment E4

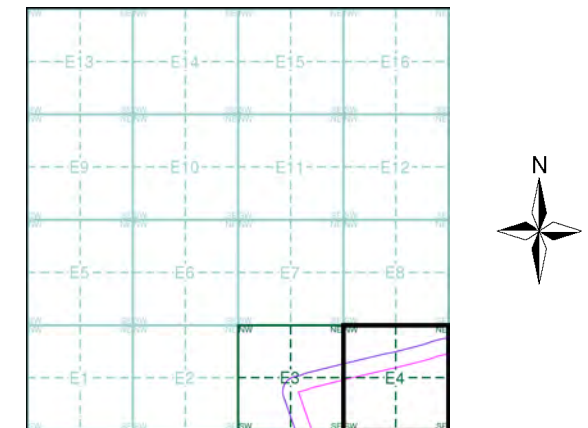

Order Details

Order Number: 297990210_1_1
 Customer Ref: 21-1088.04
 National Grid Reference: 484840, 382170
 Slice: E
 Site Area (Ha): 1120.8
 Search Buffer (m): 100

Site Details

Cottam



Tel: [Redacted]
 Fax: [Redacted]
 Web: [Redacted]

Lincolnshire
Published 1886

Source map scale - 1:2,500

The historical maps shown were reproduced from maps predominantly held at the scale adopted for England, Wales and Scotland in the 1840's. In 1854 the 1:2,500 scale was adopted for mapping urban areas and by 1896 it covered the whole of what were considered to be the cultivated parts of Great Britain. The published date given below is often some years later than the surveyed date. Before 1938, all OS maps were based on the Cassini Projection, with independent surveys of a single county or group of counties, giving rise to significant inaccuracies in outlying areas.

Map Name(s) and Date(s)

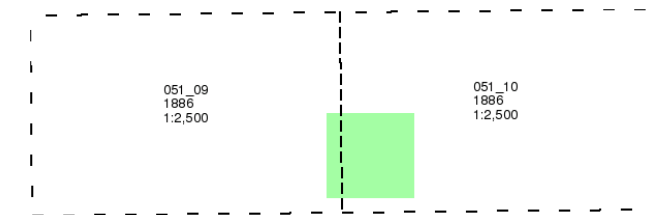

Historical Map - Segment E4

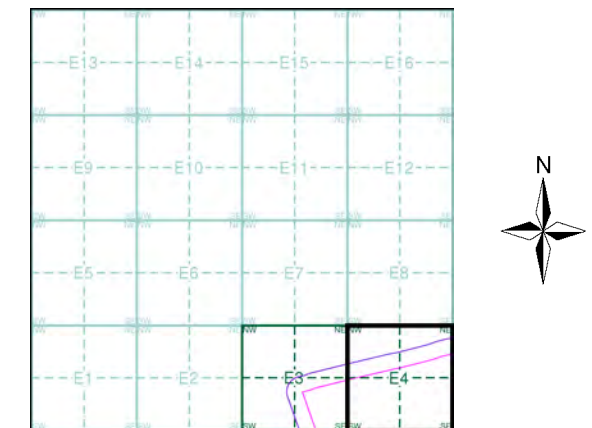

Order Details

Order Number: 297990210_1_1
 Customer Ref: 21-1088.04
 National Grid Reference: 484840, 382170
 Slice: E
 Site Area (Ha): 1120.8
 Search Buffer (m): 100

Site Details

Cottam

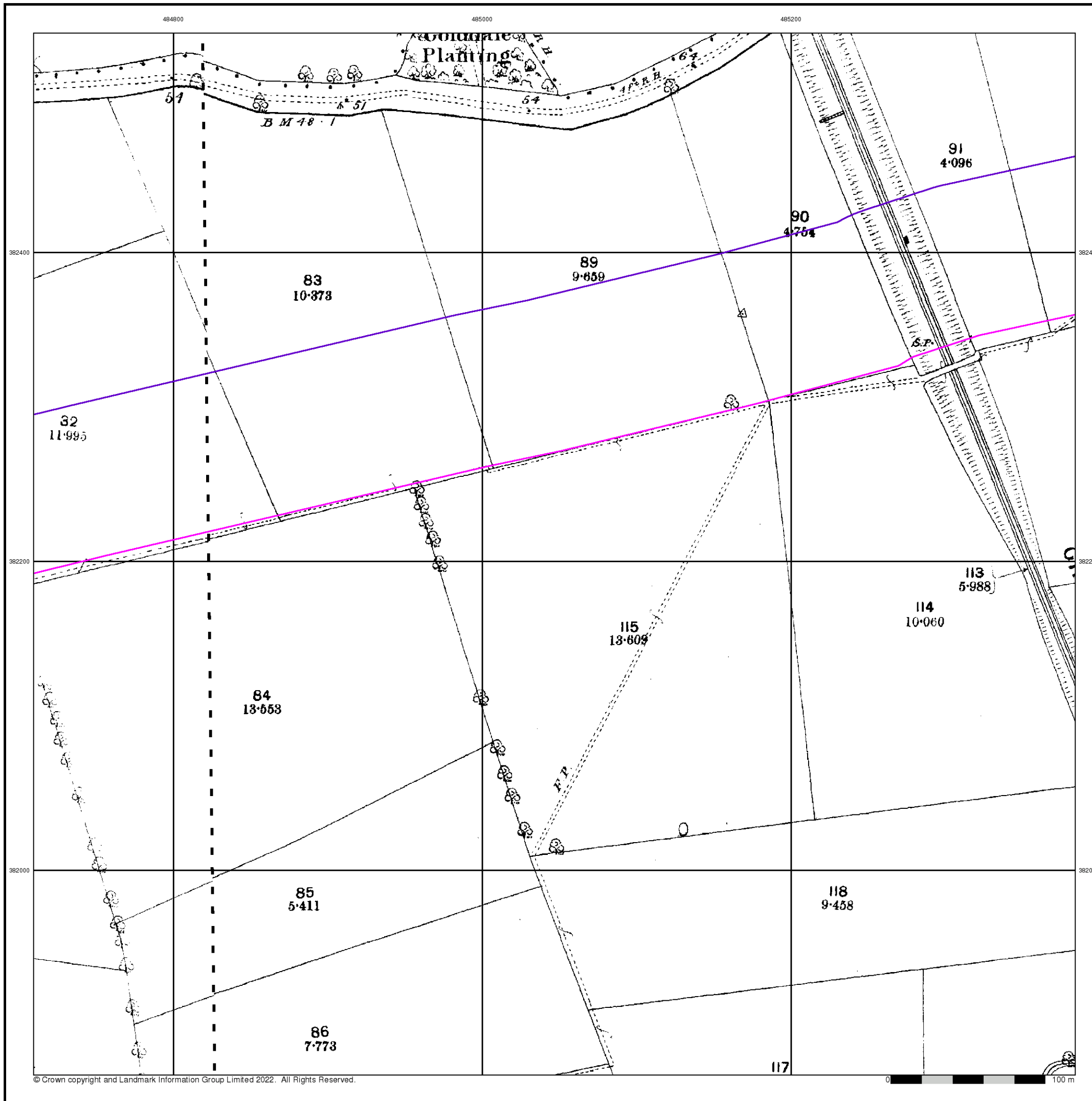

Nottinghamshire

Published 1899

Source map scale - 1:2,500

The historical maps shown were reproduced from maps predominantly held at the scale adopted for England, Wales and Scotland in the 1840's. In 1854 the 1:2,500 scale was adopted for mapping urban areas and by 1896 it covered the whole of what were considered to be the cultivated parts of Great Britain. The published date given below is often some years later than the surveyed date. Before 1938, all OS maps were based on the Cassini Projection, with independent surveys of a single county or group of counties, giving rise to significant inaccuracies in outlying areas.

Map Name(s) and Date(s)

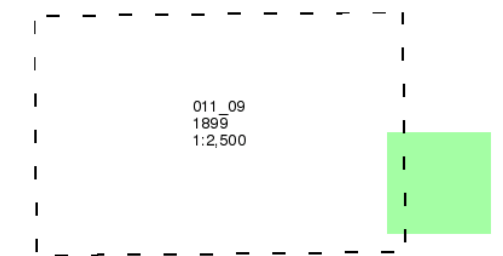

Historical Map - Segment E4

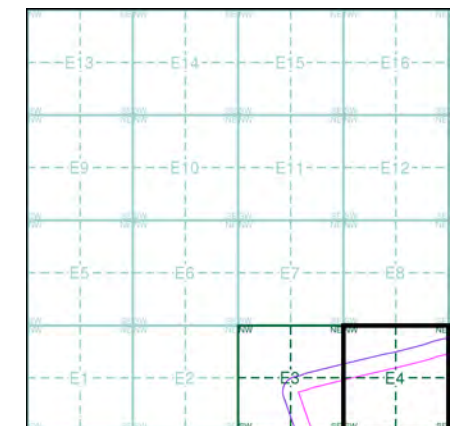

Order Details

Order Number: 297990210_1_1
 Customer Ref: 21-1088.04
 National Grid Reference: 484840, 382170
 Slice: E
 Site Area (Ha): 1120.8
 Search Buffer (m): 100

Site Details

Cottam

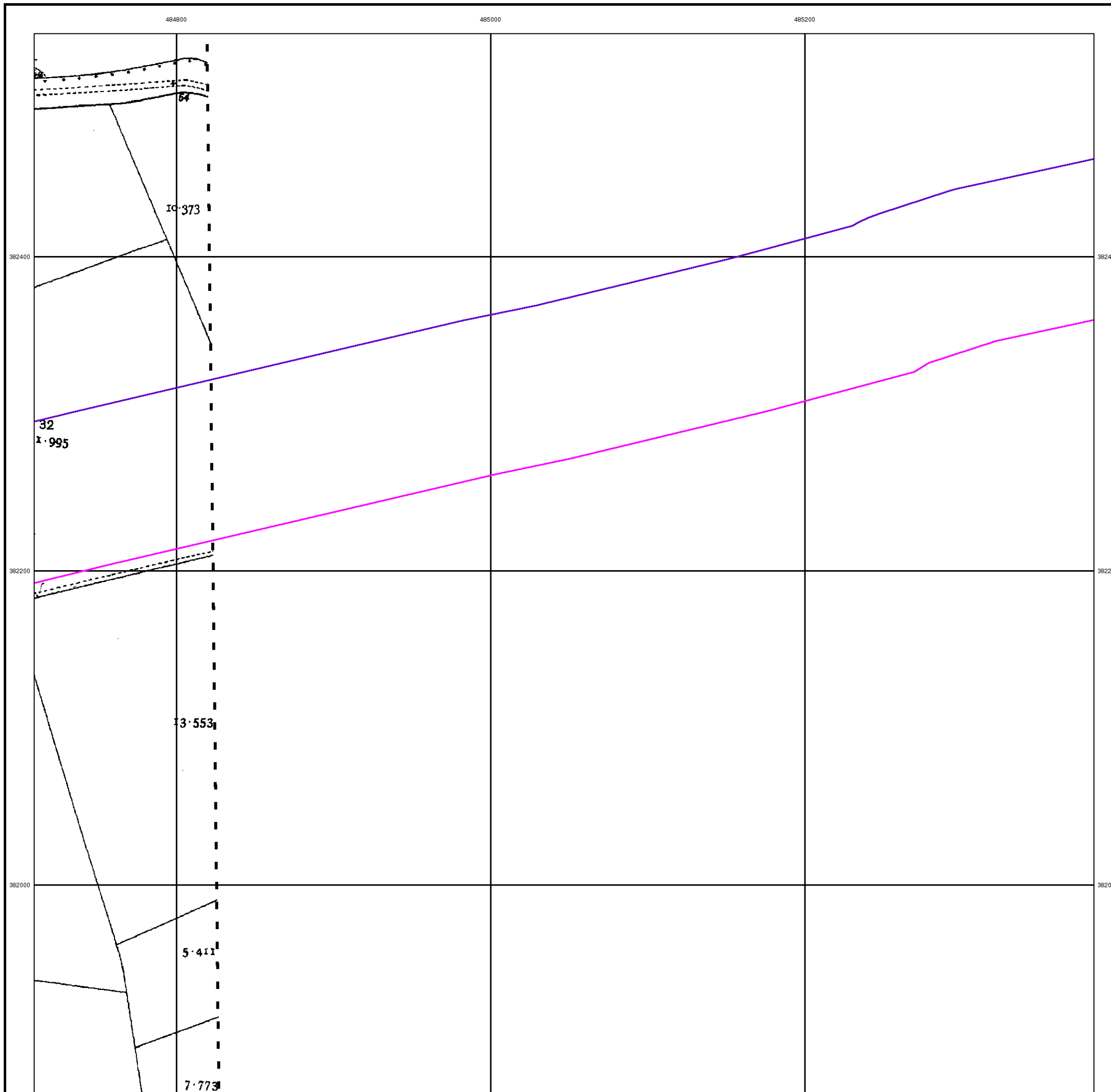

Lincolnshire

Published 1906

Source map scale - 1:2,500

The historical maps shown were reproduced from maps predominantly held at the scale adopted for England, Wales and Scotland in the 1840's. In 1854 the 1:2,500 scale was adopted for mapping urban areas and by 1896 it covered the whole of what were considered to be the cultivated parts of Great Britain. The published date given below is often some years later than the surveyed date. Before 1938, all OS maps were based on the Cassini Projection, with independent surveys of a single county or group of counties, giving rise to significant inaccuracies in outlying areas.

Map Name(s) and Date(s)

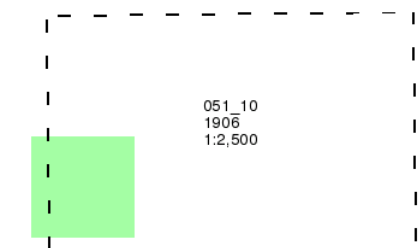

Historical Map - Segment E4

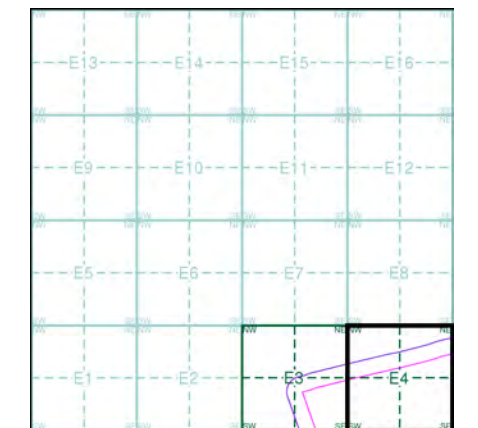

Order Details

Order Number: 297990210_1_1
 Customer Ref: 21-1088.04
 National Grid Reference: 484840, 382170
 Slice: E
 Site Area (Ha): 1120.8
 Search Buffer (m): 100

Site Details

Cottam

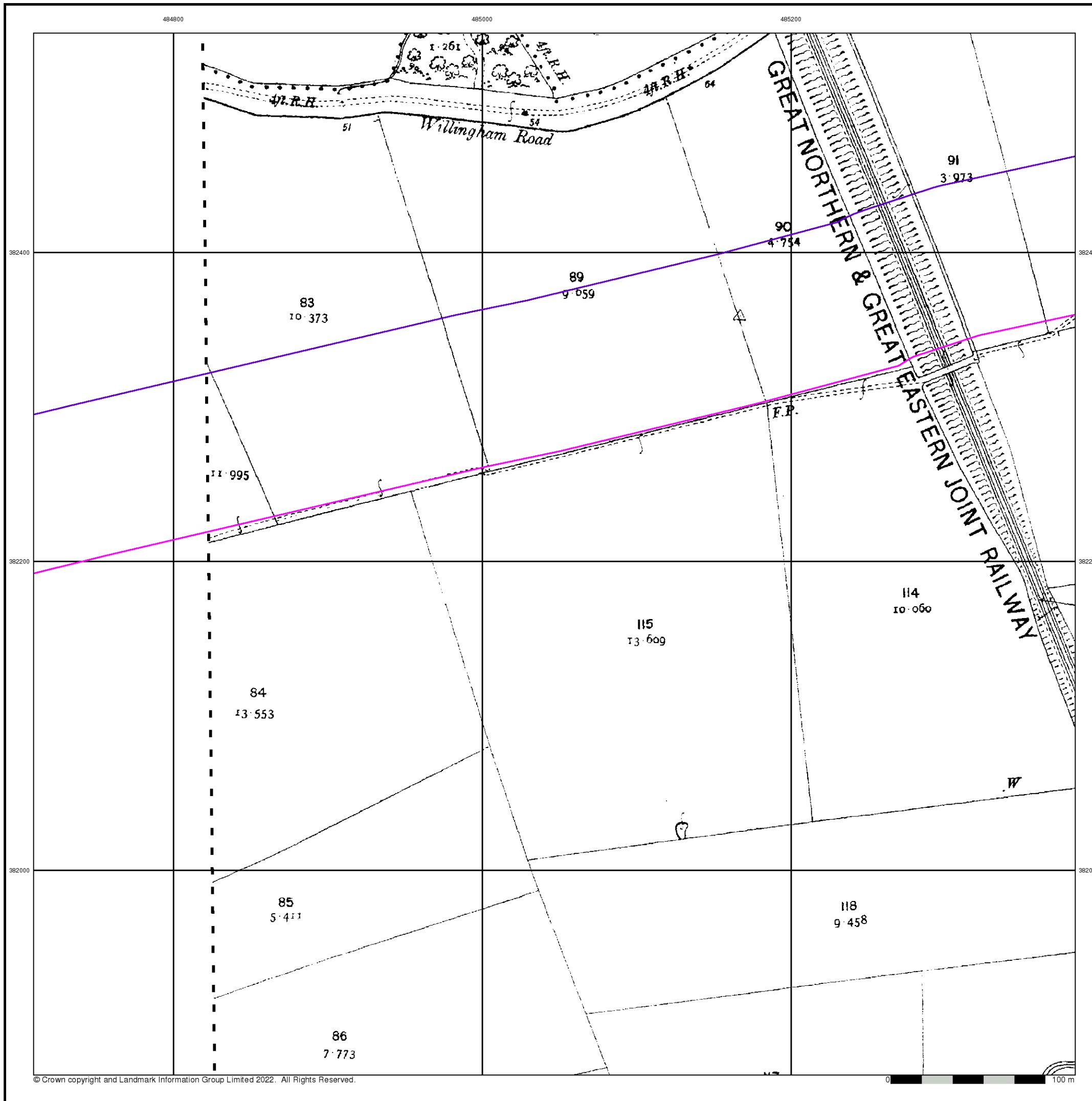

Lincolnshire

Published 1920

Source map scale - 1:2,500

The historical maps shown were reproduced from maps predominantly held at the scale adopted for England, Wales and Scotland in the 1840's. In 1854 the 1:2,500 scale was adopted for mapping urban areas and by 1896 it covered the whole of what were considered to be the cultivated parts of Great Britain. The published date given below is often some years later than the surveyed date. Before 1938, all OS maps were based on the Cassini Projection, with independent surveys of a single county or group of counties, giving rise to significant inaccuracies in outlying areas.

Map Name(s) and Date(s)

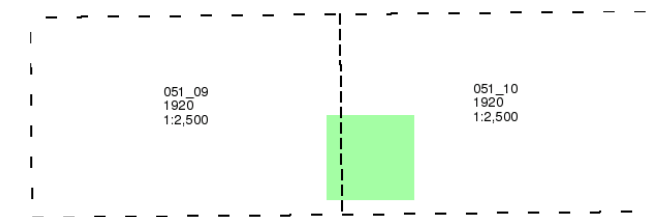

Historical Map - Segment E4

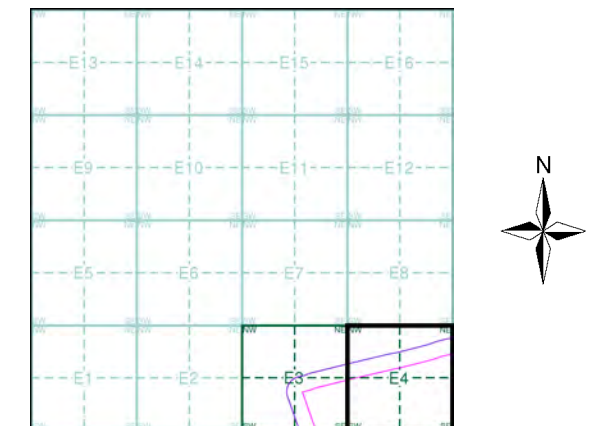

Order Details

Order Number: 297990210_1_1
 Customer Ref: 21-1088.04
 National Grid Reference: 484840, 382170
 Slice: E
 Site Area (Ha): 1120.8
 Search Buffer (m): 100

Site Details

Cottam

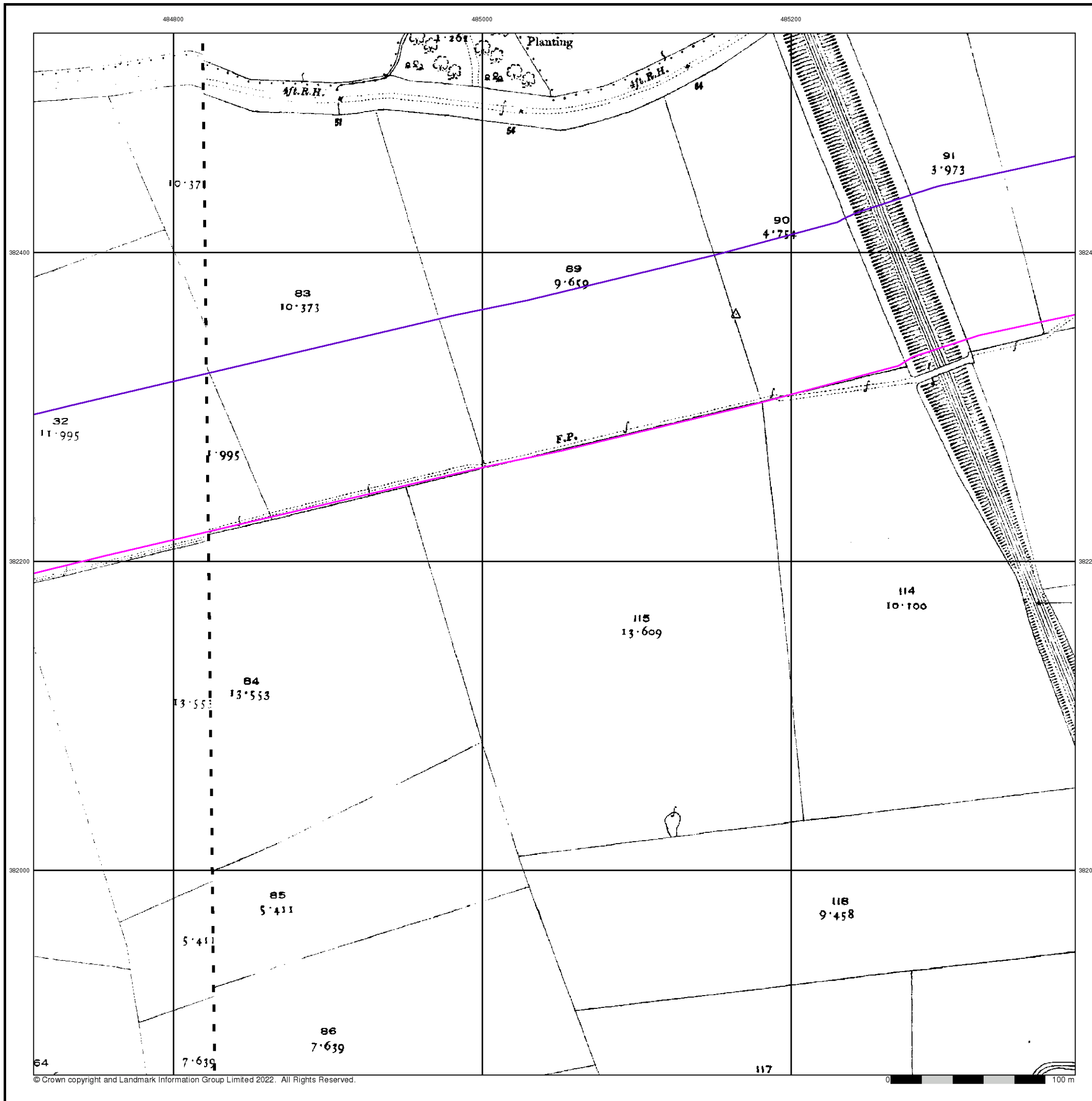

Ordnance Survey Plan
Published 1974 - 1975
Source map scale - 1:2,500

The historical maps shown were reproduced from maps predominantly held at the scale adopted for England, Wales and Scotland in the 1840's. In 1854 the 1:2,500 scale was adopted for mapping urban areas and by 1896 it covered the whole of what were considered to be the cultivated parts of Great Britain. The published date given below is often some years later than the surveyed date. Before 1938, all OS maps were based on the Cassini Projection, with independent surveys of a single county or group of counties, giving rise to significant inaccuracies in outlying areas.

Map Name(s) and Date(s)

SK8482 1975 1:2,500	SK8582 1975 1:2,500
SK8481 1974 1:2,500	SK8581 1974 1:2,500

Historical Map - Segment E4

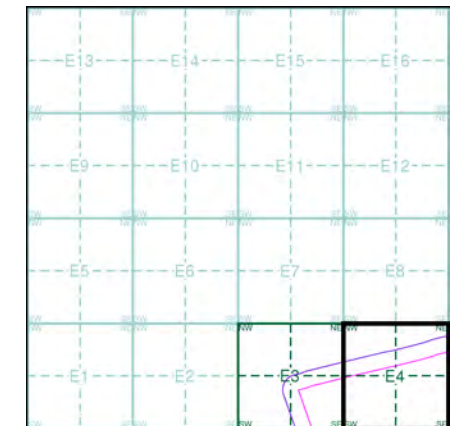

Order Details

Order Number: 297990210_1_1
 Customer Ref: 21-1088.04
 National Grid Reference: 484840, 382170
 Slice: E
 Site Area (Ha): 1120.8
 Search Buffer (m): 100

Site Details

Cottam

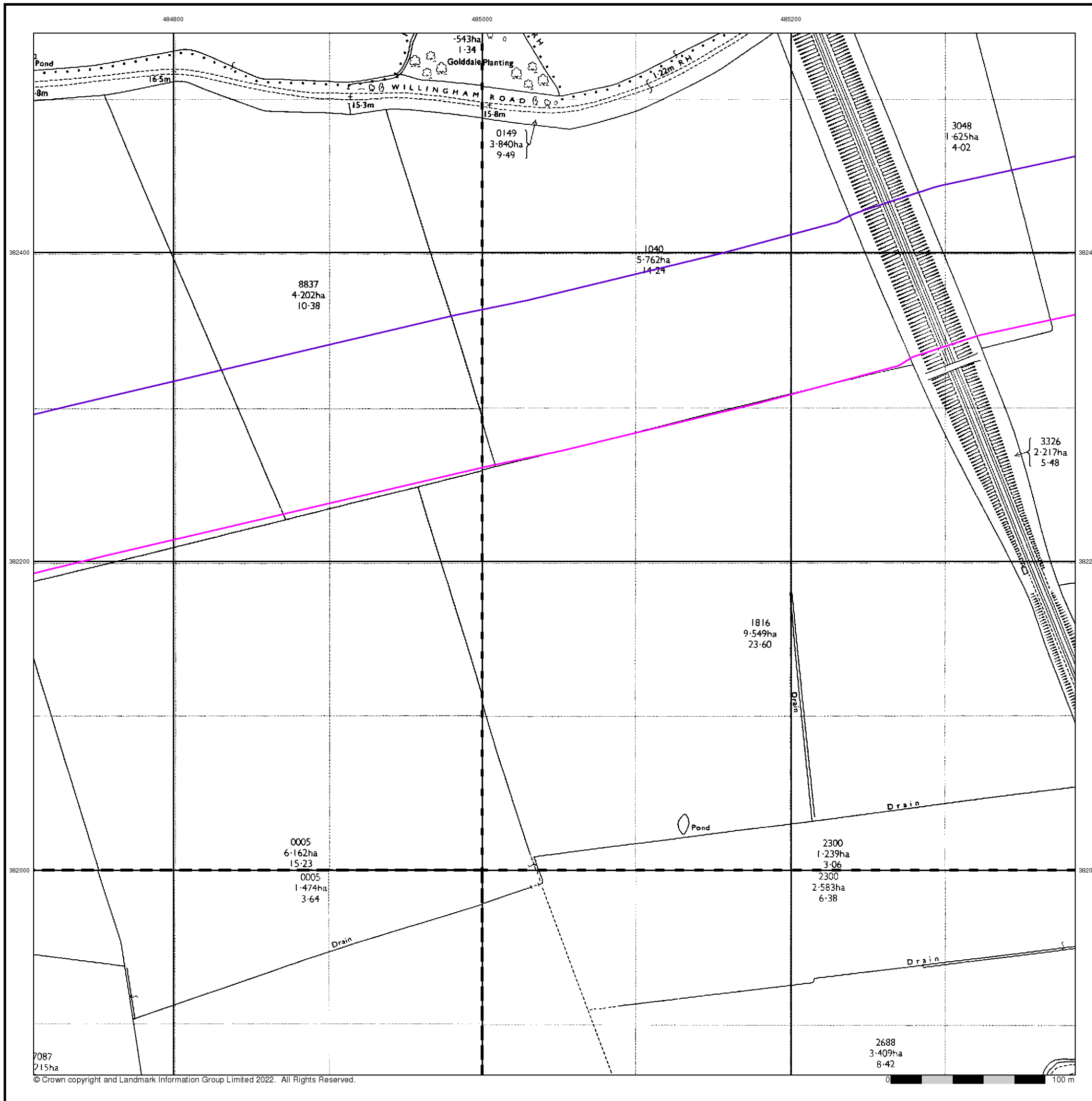

Additional SIMs

Published 1993

Source map scale - 1:2,500

The SIM cards (Ordnance Survey's 'Survey of Information on Microfilm') are further, minor editions of mapping which were produced and published in between the main editions as an area was updated. They date from 1947 to 1994, and contain detailed information on buildings, roads and land-use. These maps were produced at both 1:2,500 and 1:1,250 scales.

Map Name(s) and Date(s)

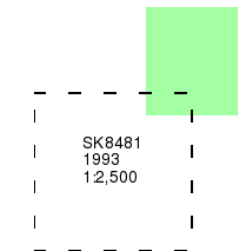

Historical Map - Segment E4

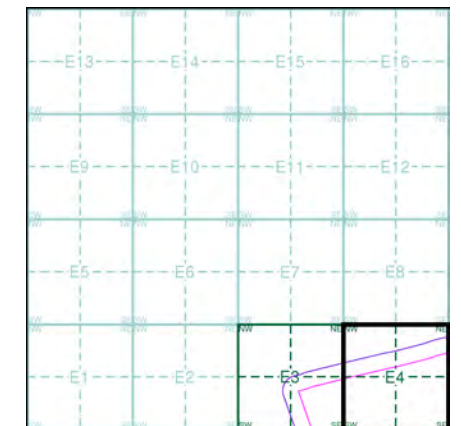

Order Details

Order Number: 297990210_1_1
 Customer Ref: 21-1088.04
 National Grid Reference: 484840, 382170
 Slice: E
 Site Area (Ha): 1120.8
 Search Buffer (m): 100

Site Details

Cottam

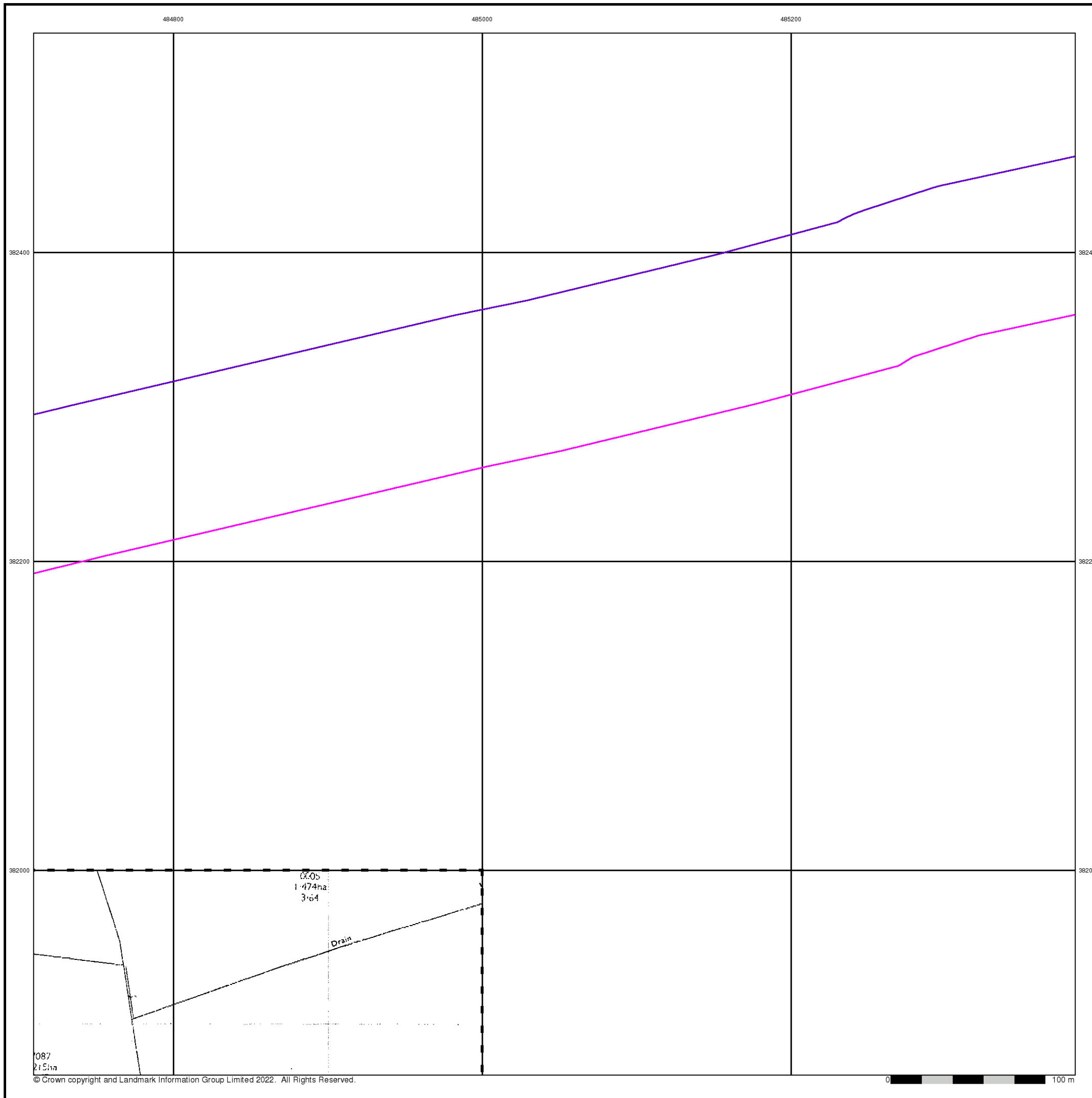

Large-Scale National Grid Data
Published 1994
Source map scale - 1:2,500

'Large Scale National Grid Data' superseded SIM cards (Ordnance Survey's 'Survey of Information on Microfilm') in 1992, and continued to be produced until 1999. These maps were the fore-runners of digital mapping and so provide detailed information on houses and roads, but tend to show less topographic features such as vegetation. These maps were produced at both 1:2,500 and 1:1,250 scales.

Map Name(s) and Date(s)

SK8482 1994 1:2,500	SK8582 1994 1:2,500
SK8481 1994 1:2,500	SK8581 1994 1:2,500

Historical Map - Segment E4

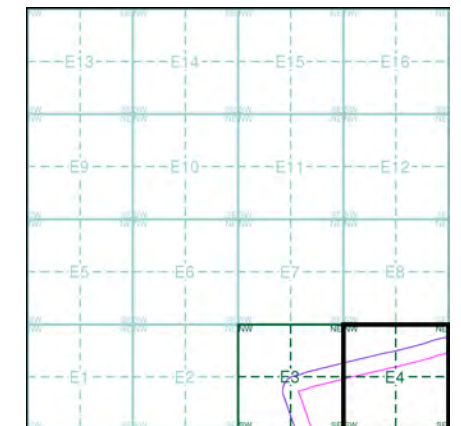

Order Details

Order Number: 297990210_1_1
 Customer Ref: 21-1088.04
 National Grid Reference: 484840, 382170
 Slice: E
 Site Area (Ha): 1120.8
 Search Buffer (m): 100

Site Details

Cottam

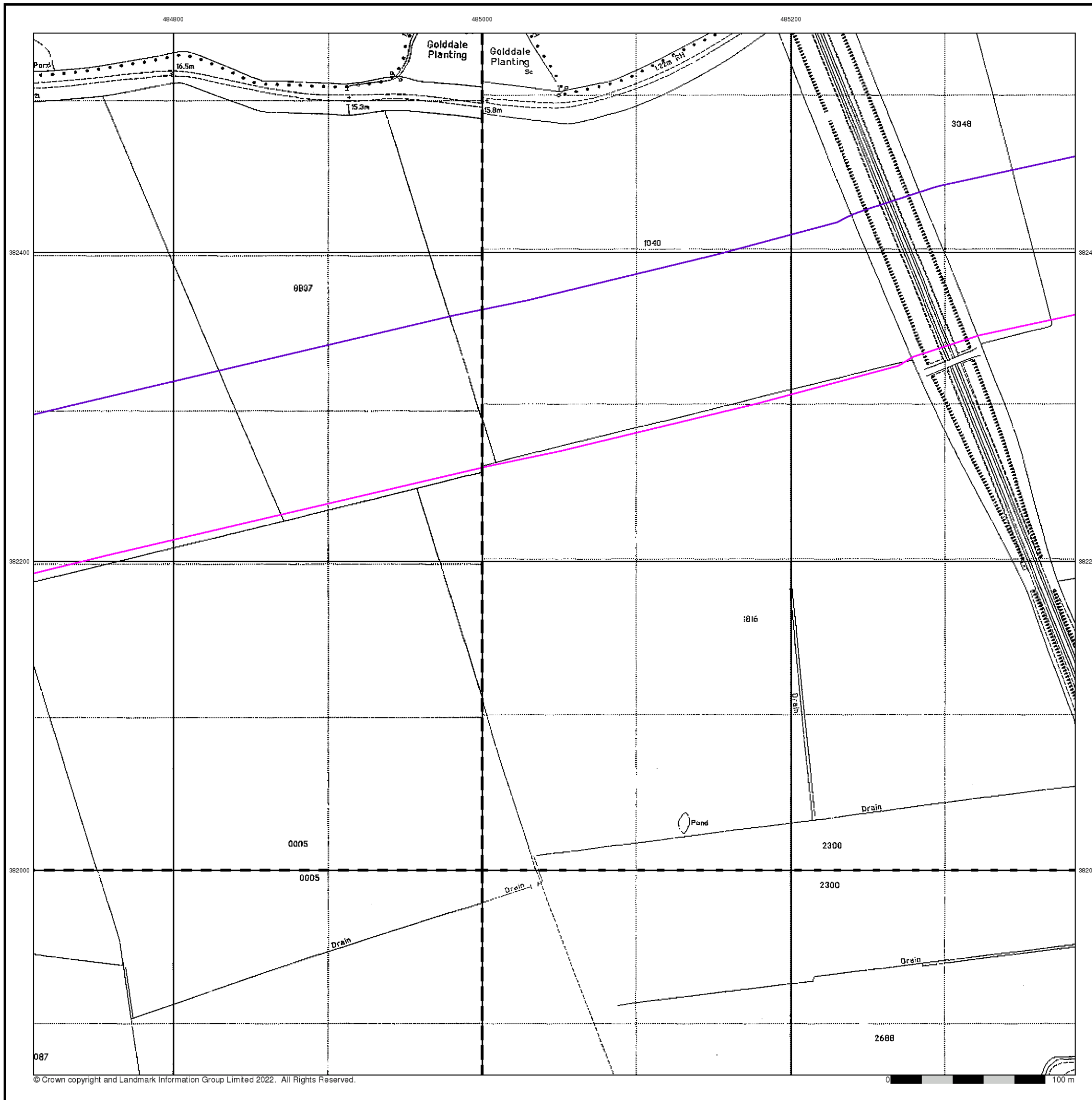

Historical Mapping Legends

Ordnance Survey County Series 1:10,560

- Gravel Pit
- Sand Pit
- Other Pits
- Quarry
- Shingle
- Orchard
- Osiers
- Reeds
- Marsh
- Mixed Wood
- Deciduous
- Brushwood
- Fir
- Furze
- Rough Pasture
- Arrow denotes flow of water
- Trigonometrical Station
- Site of Antiquities
- Bench Mark
- Pump, Guide Post, Signal Post
- Well, Spring, Boundary Post
- 285** Surface Level
- Sketched Contour
- Instrumental Contour
- Main Roads
- Minor Roads
- Sunken Road
- Raised Road
- Road over Railway
- Railway over River
- Railway over Road
- Level Crossing
- Road over River or Canal
- Road over Stream
- Road over Stream
- County Boundary (Geographical)
- County & Civil Parish Boundary
- Administrative County & Civil Parish Boundary
- County Borough Boundary (England)
- County Burgh Boundary (Scotland)
- Rural District Boundary
- Civil Parish Boundary

Ordnance Survey Plan 1:10,000

- Chalk Pit, Clay Pit or Quarry
- Gravel Pit
- Sand Pit
- Disused Pit or Quarry
- Refuse or Slag Heap
- Lake, Loch or Pond
- Dunes
- Boulders
- Coniferous Trees
- Non-Coniferous Trees
- Orchard
- Scrub
- Coppice
- Bracken
- Heath
- Rough Grassland
- Marsh
- Reeds
- Saltings
- Building
- Glasshouse
- Sloping Masonry
- Pylon
- Electricity Transmission Line
- Pole
- Cutting
- Embankment
- Standard Gauge Multiple Track
- Standard Gauge Single Track
- Siding, Tramway or Mineral Line
- Narrow Gauge
- Geographical County
- Administrative County, County Borough or County of City
- Municipal Borough, Urban or Rural District, Burgh or District Council
- Borough, Burgh or County Constituency
Shown only when not coincident with other boundaries
- Civil Parish
Shown alternately when coincidence of boundaries occurs
- BP, BS Boundary Post or Stone
- Ch Church
- CH Club House
- F E Sta Fire Engine Station
- FB Foot Bridge
- Fn Fountain
- GP Guide Post
- MP Mile Post
- MS Mile Stone
- Pol Sta Police Station
- PO Post Office
- PC Public Convenience
- PH Public House
- SB Signal Box
- Spr Spring
- TCB Telephone Call Box
- TCP Telephone Call Post
- W Well

1:10,000 Raster Mapping

- Gravel Pit
- Rock
- Boulders
- Shingle
- Sand
- Slopes
- General detail
- Overhead detail
- Multi-track railway
- County boundary (England only)
- District, Unitary, Metropolitan, London Borough boundary
- Area of wooded vegetation
- Non-coniferous trees (scattered)
- Coniferous trees (scattered)
- Orchard
- Rough Grassland
- Scrub
- Water feature
- MHW(S) Mean high water (springs)
- Bench mark (where shown)
- Point feature (e.g. Guide Post or Mile Stone)
- Site of (antiquity)
- General Building
- Refuse tip or slag heap
- Rock (scattered)
- Boulders (scattered)
- Mud
- Sand Pit
- Top of cliff
- Underground detail
- Narrow gauge railway
- Single track railway
- Civil, parish or community boundary
- Constituency boundary
- Non-coniferous trees
- Coniferous trees
- Positioned tree
- Coppice or Osiers
- Heath
- Marsh, Salt Marsh or Reeds
- Flow arrows
- MLW(S) Mean low water (springs)
- Triangulation station
- Pylon, flare stack or lighting tower
- Glasshouse
- Important Building



Historical Mapping & Photography included:

Mapping Type	Scale	Date	Pg
Lincolnshire	1:10,560	1885	2
Nottinghamshire	1:10,560	1900	3
Lincolnshire	1:10,560	1906 - 1907	4
Lincolnshire	1:10,560	1907	5
Lincolnshire	1:10,560	1921 - 1922	6
Lincolnshire	1:10,560	1921 - 1922	7
Lincolnshire	1:10,560	1947	8
Ordnance Survey Plan	1:10,000	1956	9
Ordnance Survey Plan	1:10,000	1981	10
10K Raster Mapping	1:10,000	2000	11
Street View	Variable		12

Historical Map - Slice F

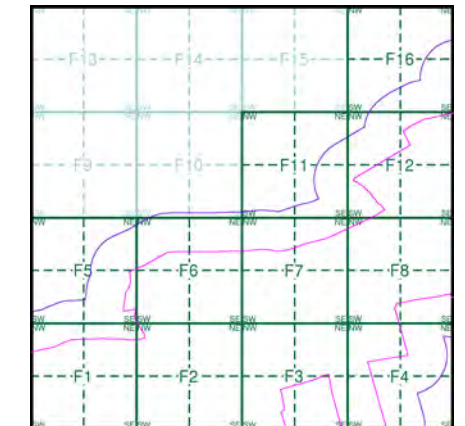

Order Details

Order Number: 297990210_1_1
 Customer Ref: 21-1088.04
 National Grid Reference: 486940, 382710
 Slice: F
 Site Area (Ha): 1120.8
 Search Buffer (m): 250

Site Details

Cottam



Tel:
Fax:
Web:

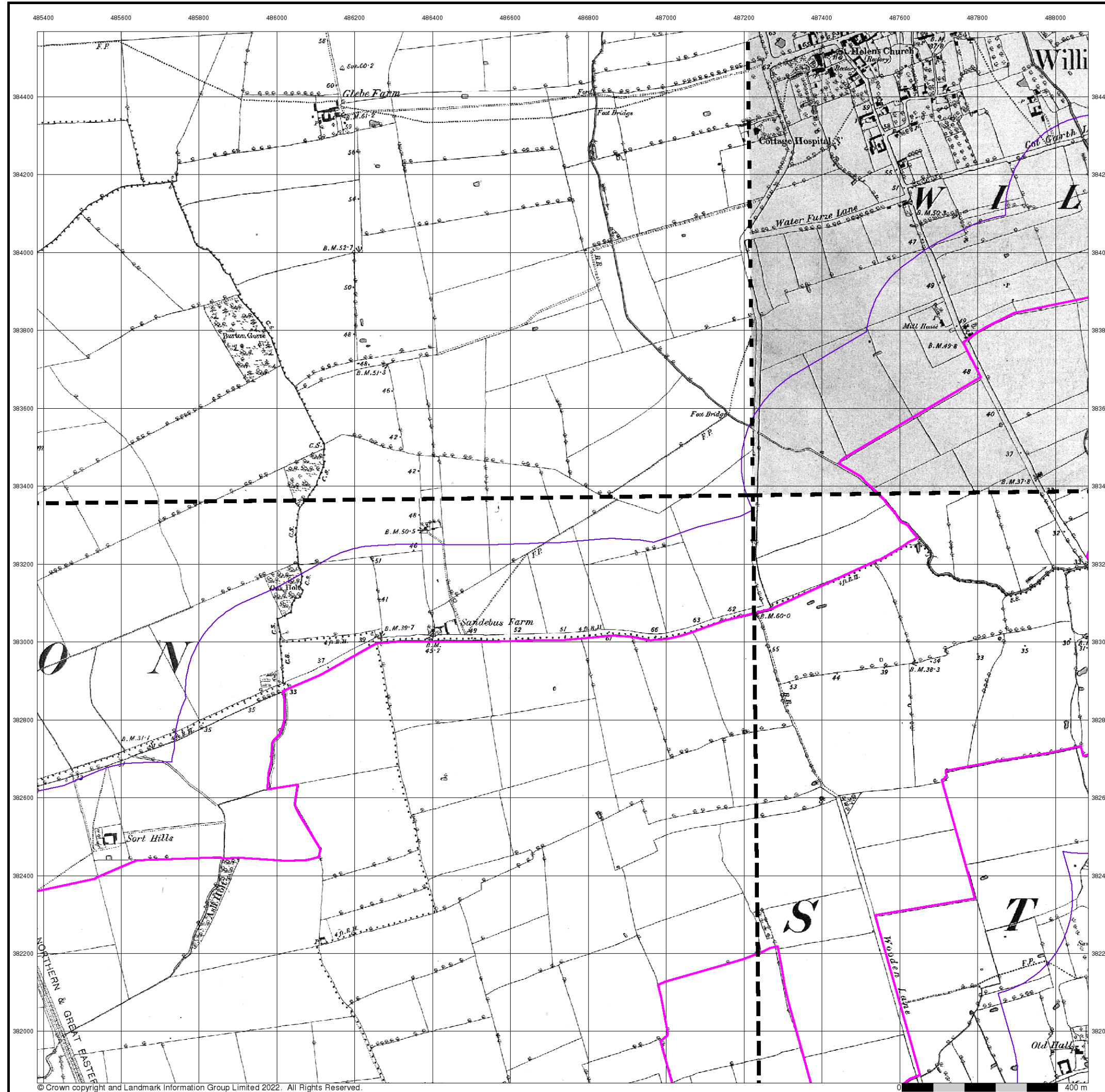

© Crown copyright and Landmark Information Group Limited 2022. All Rights Reserved.



Lincolnshire
Published 1885
Source map scale - 1:10,560

The historical maps shown were reproduced from maps predominantly held at the scale adopted for England, Wales and Scotland in the 1840's. In 1854 the 1:2,500 scale was adopted for mapping urban areas; these maps were used to update the 1:10,560 maps. The published date given therefore is often some years later than the surveyed date. Before 1938, all OS maps were based on the Cassini Projection, with independent surveys of a single county or group of counties, giving rise to significant inaccuracies in outlying areas. In the late 1940's, a Provisional Edition was produced, which updated the 1:10,560 mapping from a number of sources. The maps appear unfinished - with all military camps and other strategic sites removed. These maps were initially overprinted with the National Grid. In 1970, the first 1:10,000 maps were produced using the Transverse Mercator Projection. The revision process continued until recently, with new editions appearing every 10 years or so for urban areas.

Map Name(s) and Date(s)

051NW 1885 1:10,560	051NE 1885 1:10,560
051SW 1885 1:10,560	051SE 1885 1:10,560

Historical Map - Slice F

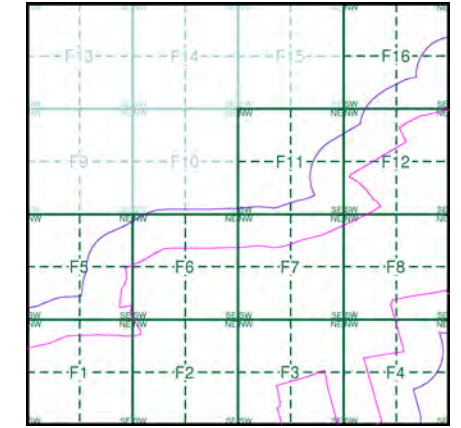

Order Details

Order Number: 297990210_1_1
 Customer Ref: 21-1088.04
 National Grid Reference: 486940, 382710
 Slice: F
 Site Area (Ha): 1120.8
 Search Buffer (m): 250

Site Details

Cottam



Tel: [Redacted]
 Fax: [Redacted]
 Web: [Redacted]

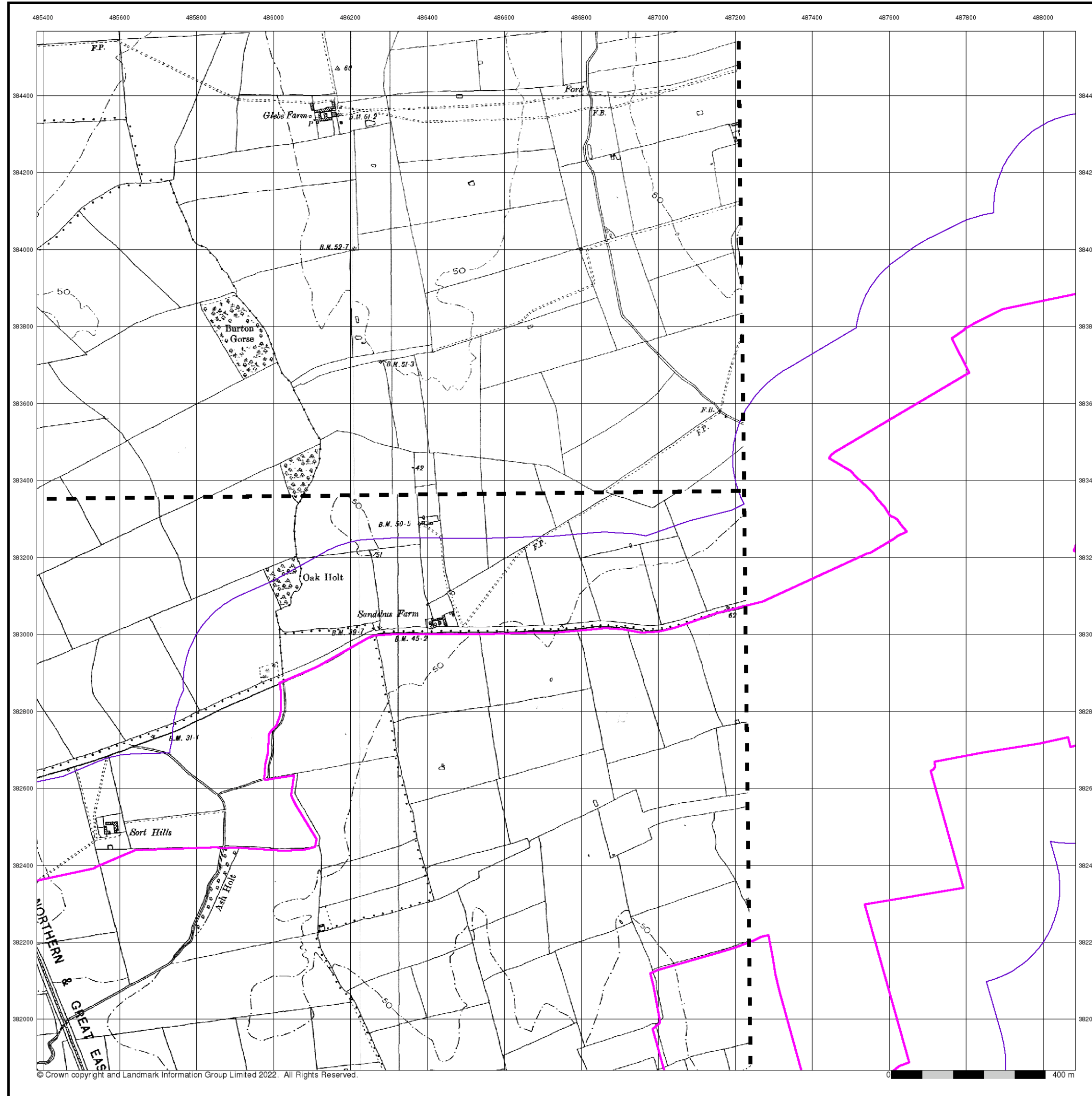

© Crown copyright and Landmark Information Group Limited 2022. All Rights Reserved.



Nottinghamshire
Published 1900
Source map scale - 1:10,560

The historical maps shown were reproduced from maps predominantly held at the scale adopted for England, Wales and Scotland in the 1840's. In 1854 the 1:2,500 scale was adopted for mapping urban areas; these maps were used to update the 1:10,560 maps. The published date given therefore is often some years later than the surveyed date. Before 1938, all OS maps were based on the Cassini Projection, with independent surveys of a single county or group of counties, giving rise to significant inaccuracies in outlying areas. In the late 1940's, a Provisional Edition was produced, which updated the 1:10,560 mapping from a number of sources. The maps appear unfinished - with all military camps and other strategic sites removed. These maps were initially overprinted with the National Grid. In 1970, the first 1:10,000 maps were produced using the Transverse Mercator Projection. The revision process continued until recently, with new editions appearing every 10 years or so for urban areas.

Map Name(s) and Date(s)

011NW	1900	1:10,560
011SW	1900	1:10,560

Historical Map - Slice F

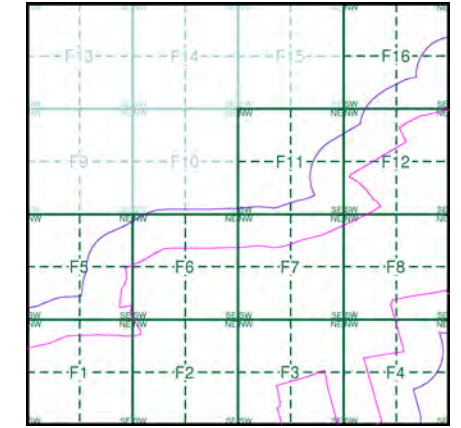

Order Details

Order Number: 297990210_1_1
 Customer Ref: 21-1088.04
 National Grid Reference: 486940, 382710
 Slice: F
 Site Area (Ha): 1120.8
 Search Buffer (m): 250

Site Details

Cottam



Tel: [Redacted]
 Fax: [Redacted]
 Web: [Redacted]

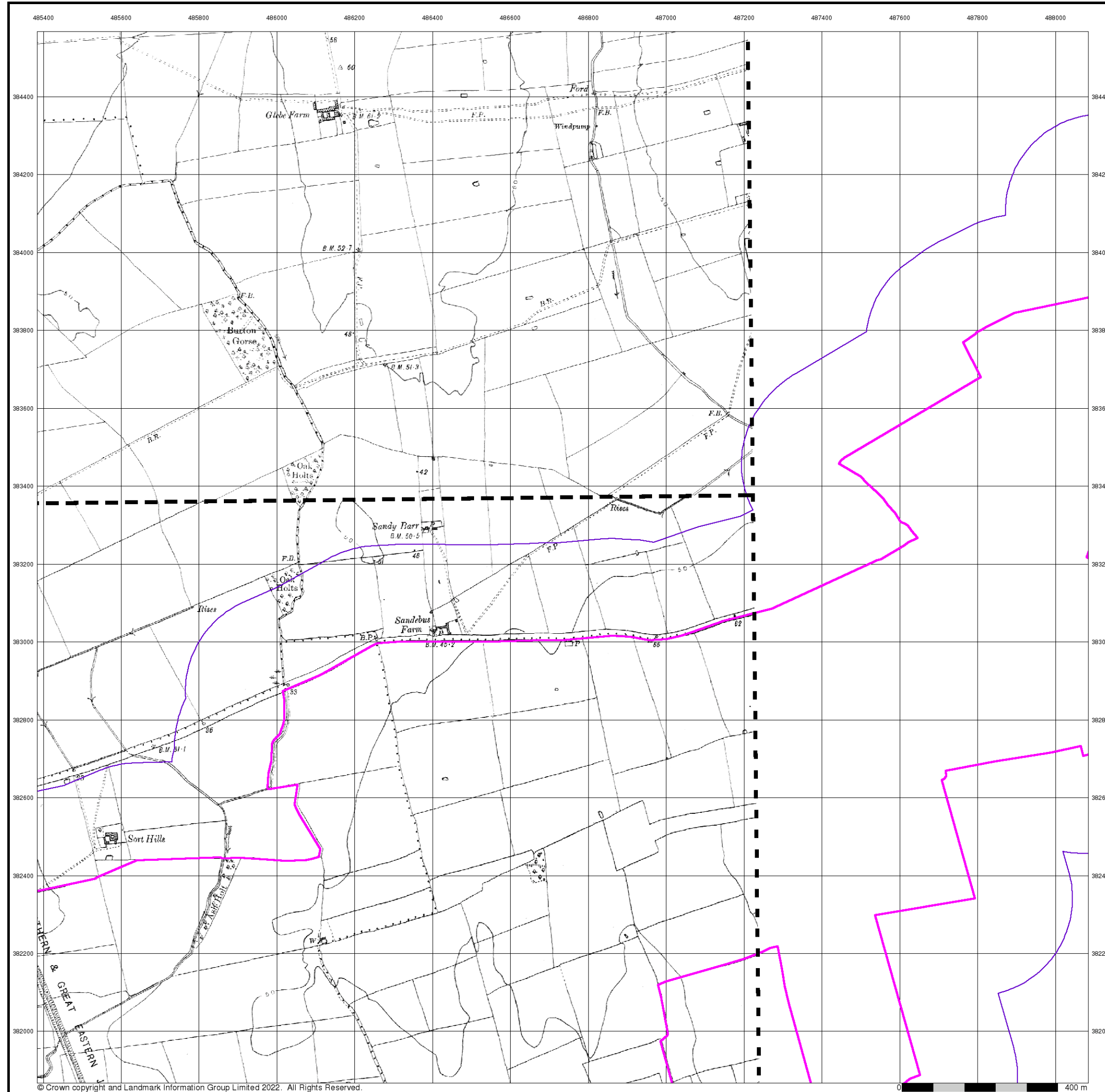

© Crown copyright and Landmark Information Group Limited 2022. All Rights Reserved.



Lincolnshire

Published 1921 - 1922

Source map scale - 1:10,560

The historical maps shown were reproduced from maps predominantly held at the scale adopted for England, Wales and Scotland in the 1840's. In 1854 the 1:2,500 scale was adopted for mapping urban areas; these maps were used to update the 1:10,560 maps. The published date given therefore is often some years later than the surveyed date. Before 1938, all OS maps were based on the Cassini Projection, with independent surveys of a single county or group of counties, giving rise to significant inaccuracies in outlying areas. In the late 1940's, a Provisional Edition was produced, which updated the 1:10,560 mapping from a number of sources. The maps appear unfinished - with all military camps and other strategic sites removed. These maps were initially overprinted with the National Grid. In 1970, the first 1:10,000 maps were produced using the Transverse Mercator Projection. The revision process continued until recently, with new editions appearing every 10 years or so for urban areas.

Map Name(s) and Date(s)

051NW	1921	1:10,560
051SW	1922	1:10,560

Historical Map - Slice F

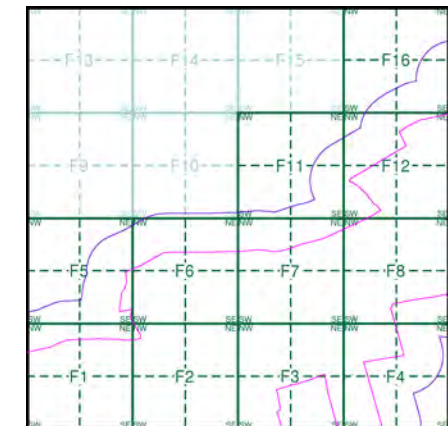

Order Details

Order Number: 297990210_1_1
 Customer Ref: 21-1088.04
 National Grid Reference: 486940, 382710
 Slice: F
 Site Area (Ha): 1120.8
 Search Buffer (m): 250

Site Details

Cottam



Tel: [Redacted]
 Fax: [Redacted]
 Web: [Redacted]

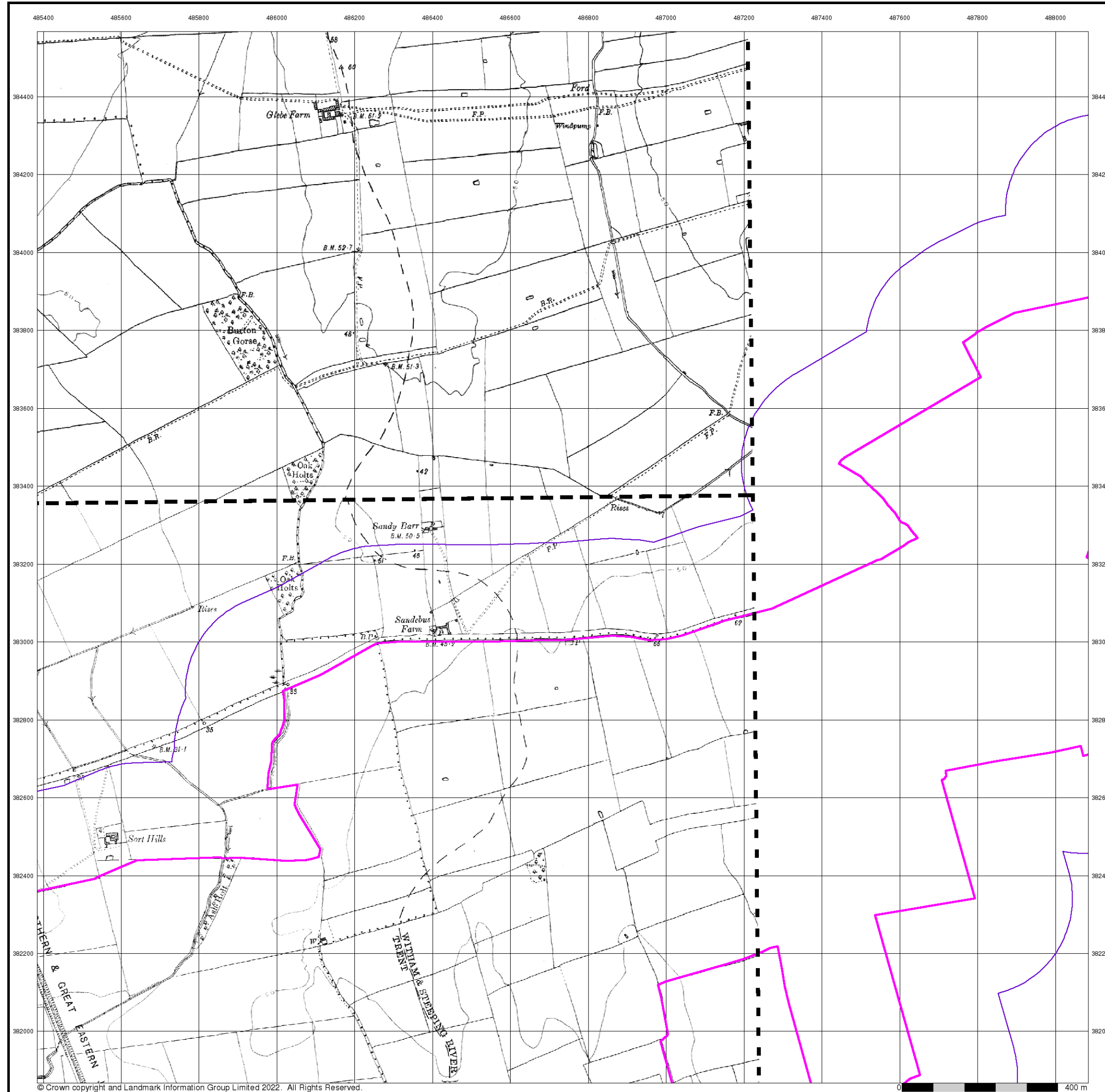

© Crown copyright and Landmark Information Group Limited 2022. All Rights Reserved.



Lincolnshire
Published 1921 - 1922
Source map scale - 1:10,560

The historical maps shown were reproduced from maps predominantly held at the scale adopted for England, Wales and Scotland in the 1840's. In 1854 the 1:2,500 scale was adopted for mapping urban areas; these maps were used to update the 1:10,560 maps. The published date given therefore is often some years later than the surveyed date. Before 1938, all OS maps were based on the Cassini Projection, with independent surveys of a single county or group of counties, giving rise to significant inaccuracies in outlying areas. In the late 1940's, a Provisional Edition was produced, which updated the 1:10,560 mapping from a number of sources. The maps appear unfinished - with all military camps and other strategic sites removed. These maps were initially overprinted with the National Grid. In 1970, the first 1:10,000 maps were produced using the Transverse Mercator Projection. The revision process continued until recently, with new editions appearing every 10 years or so for urban areas.

Map Name(s) and Date(s)

051NW	1921	1:10,560
051SW	1922	1:10,560

Historical Map - Slice F

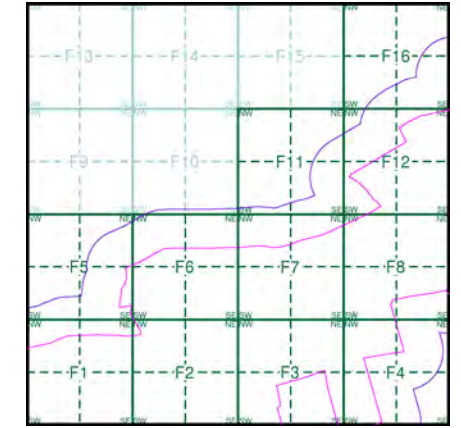

Order Details

Order Number: 297990210_1_1
 Customer Ref: 21-1088.04
 National Grid Reference: 486940, 382710
 Slice: F
 Site Area (Ha): 1120.8
 Search Buffer (m): 250

Site Details

Cottam



Tel: [Redacted]
 Fax: [Redacted]
 Web: [Redacted]

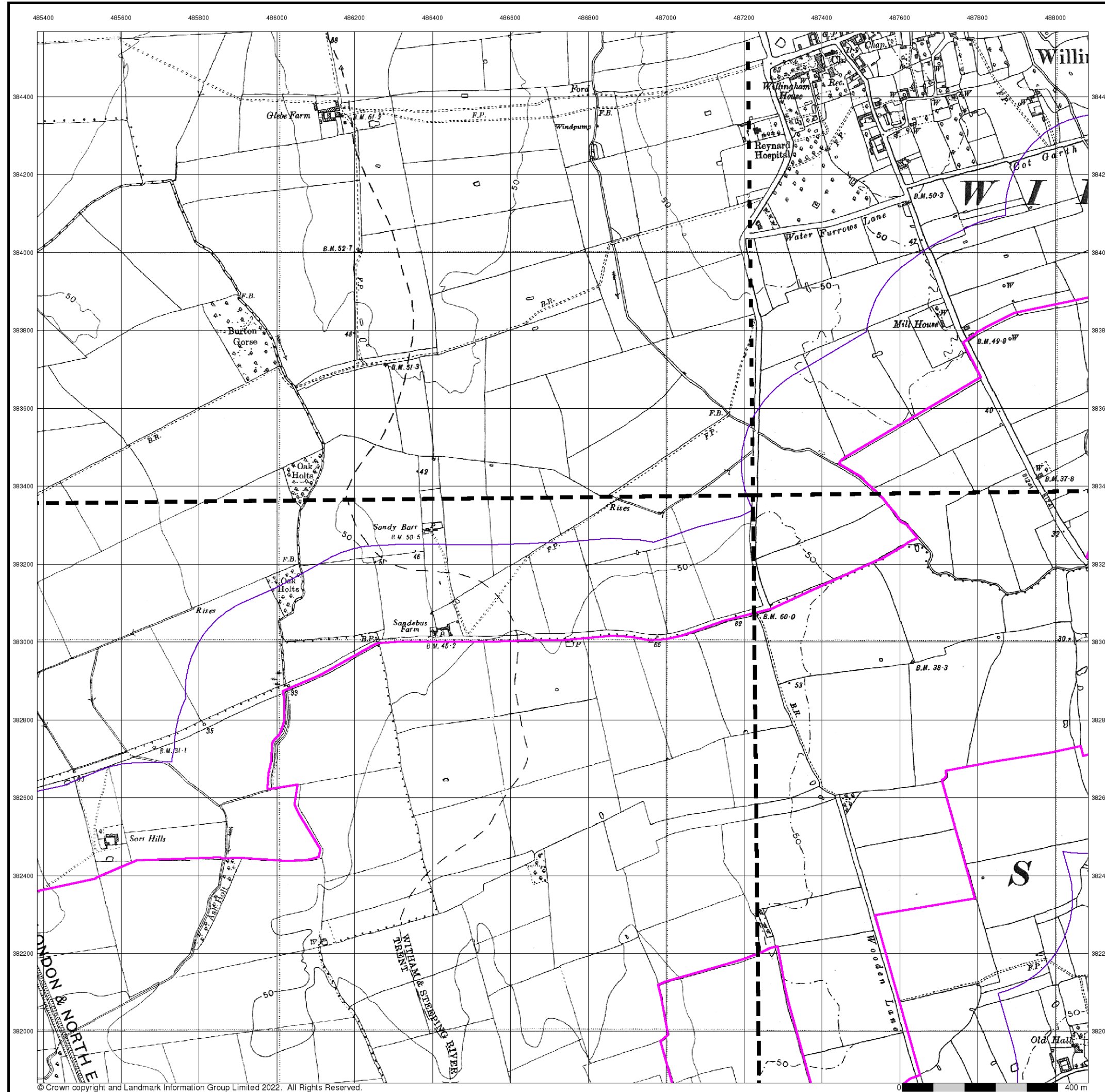

© Crown copyright and Landmark Information Group Limited 2022. All Rights Reserved.



Lincolnshire
Published 1947
Source map scale - 1:10,560

The historical maps shown were reproduced from maps predominantly held at the scale adopted for England, Wales and Scotland in the 1840's. In 1854 the 1:2,500 scale was adopted for mapping urban areas; these maps were used to update the 1:10,560 maps. The published date given therefore is often some years later than the surveyed date. Before 1938, all OS maps were based on the Cassini Projection, with independent surveys of a single county or group of counties, giving rise to significant inaccuracies in outlying areas. In the late 1940's, a Provisional Edition was produced, which updated the 1:10,560 mapping from a number of sources. The maps appear unfinished - with all military camps and other strategic sites removed. These maps were initially overprinted with the National Grid. In 1970, the first 1:10,000 maps were produced using the Transverse Mercator Projection. The revision process continued until recently, with new editions appearing every 10 years or so for urban areas.

Map Name(s) and Date(s)

051NW 1947 1:10,560	051NE 1947 1:10,560
051SW 1947 1:10,560	051SE 1947 1:10,560

Historical Map - Slice F

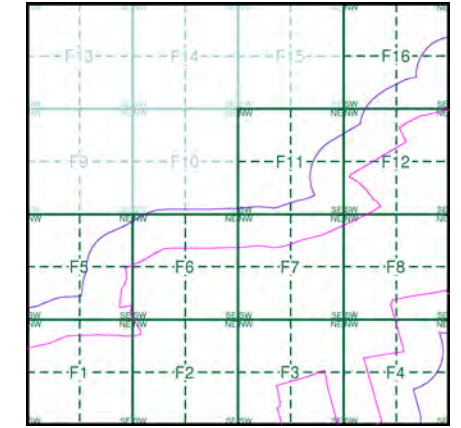

Order Details

Order Number: 297990210_1_1
 Customer Ref: 21-1088.04
 National Grid Reference: 486940, 382710
 Slice: F
 Site Area (Ha): 1120.8
 Search Buffer (m): 250

Site Details

Cottam



Tel: [Redacted]
 Fax: [Redacted]
 Web: [Redacted]

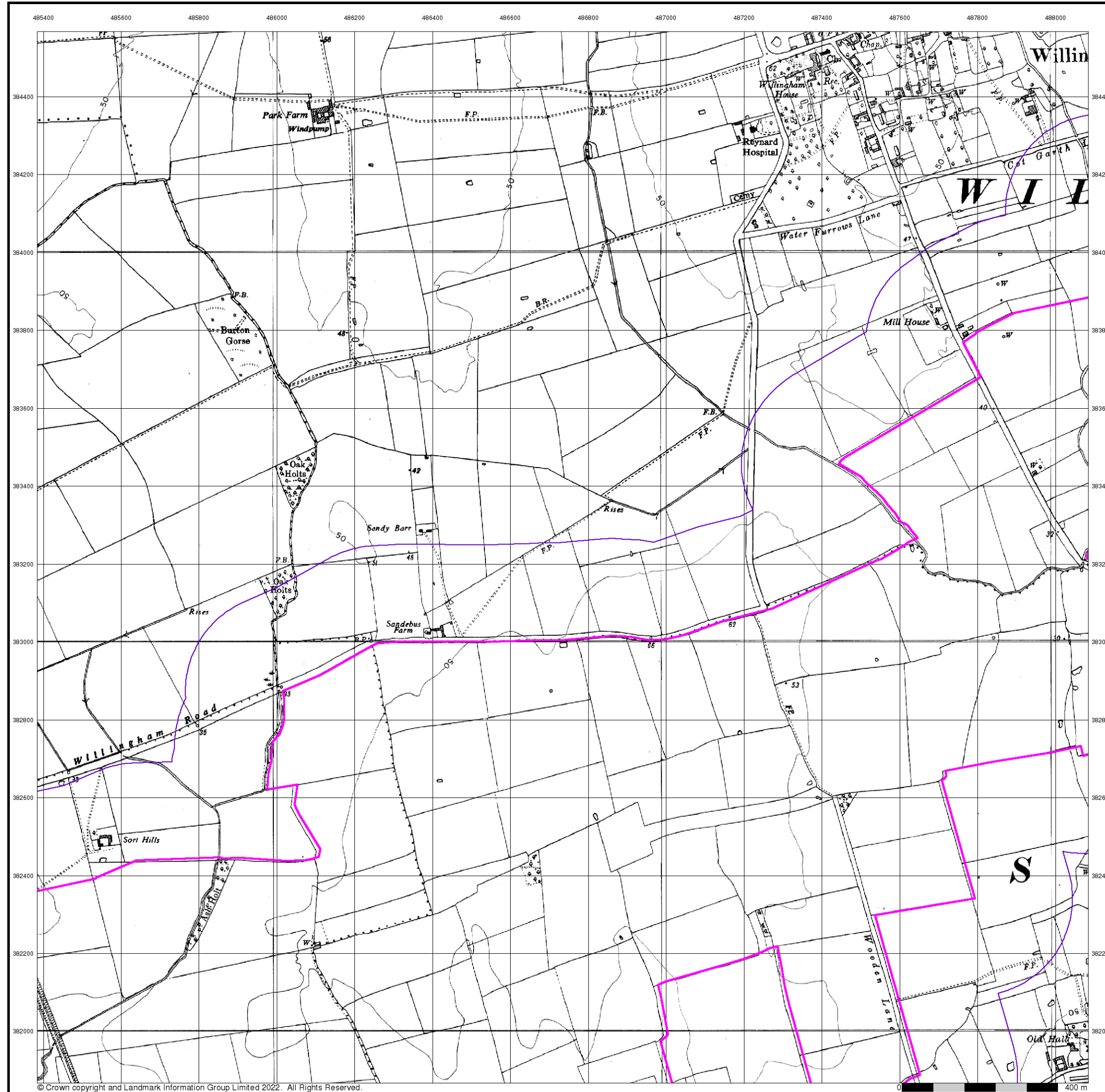

© Crown copyright and Landmark Information Group Limited 2022. All Rights Reserved.



Ordnance Survey Plan
Published 1956
Source map scale - 1:10,000

The historical maps shown were reproduced from maps predominantly held at the scale adopted for England, Wales and Scotland in the 1840's. In 1854 the 1:2,500 scale was adopted for mapping urban areas; these maps were used to update the 1:10,560 maps. The published date given therefore is often some years later than the surveyed date. Before 1938, all OS maps were based on the Cassini Projection, with independent surveys of a single county or group of counties, giving rise to significant inaccuracies in outlying areas. In the late 1940's, a Provisional Edition was produced, which updated the 1:10,560 mapping from a number of sources. The maps appear unfinished - with all military camps and other strategic sites removed. These maps were initially overprinted with the National Grid. In 1970, the first 1:10,000 maps were produced using the Transverse Mercator Projection. The revision process continued until recently, with new editions appearing every 10 years or so for urban areas.

Map Name(s) and Date(s)

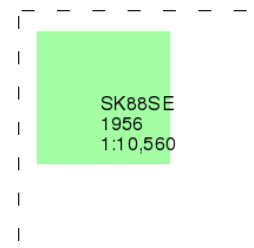

Historical Map - Slice F

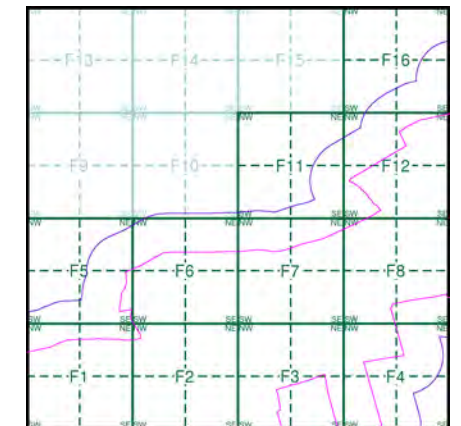

Order Details

Order Number: 297990210_1_1
 Customer Ref: 21-1088.04
 National Grid Reference: 486940, 382710
 Slice: F
 Site Area (Ha): 1120.8
 Search Buffer (m): 250

Site Details

Cottam



Tel: [Redacted]
 Fax: [Redacted]
 Web: [Redacted]

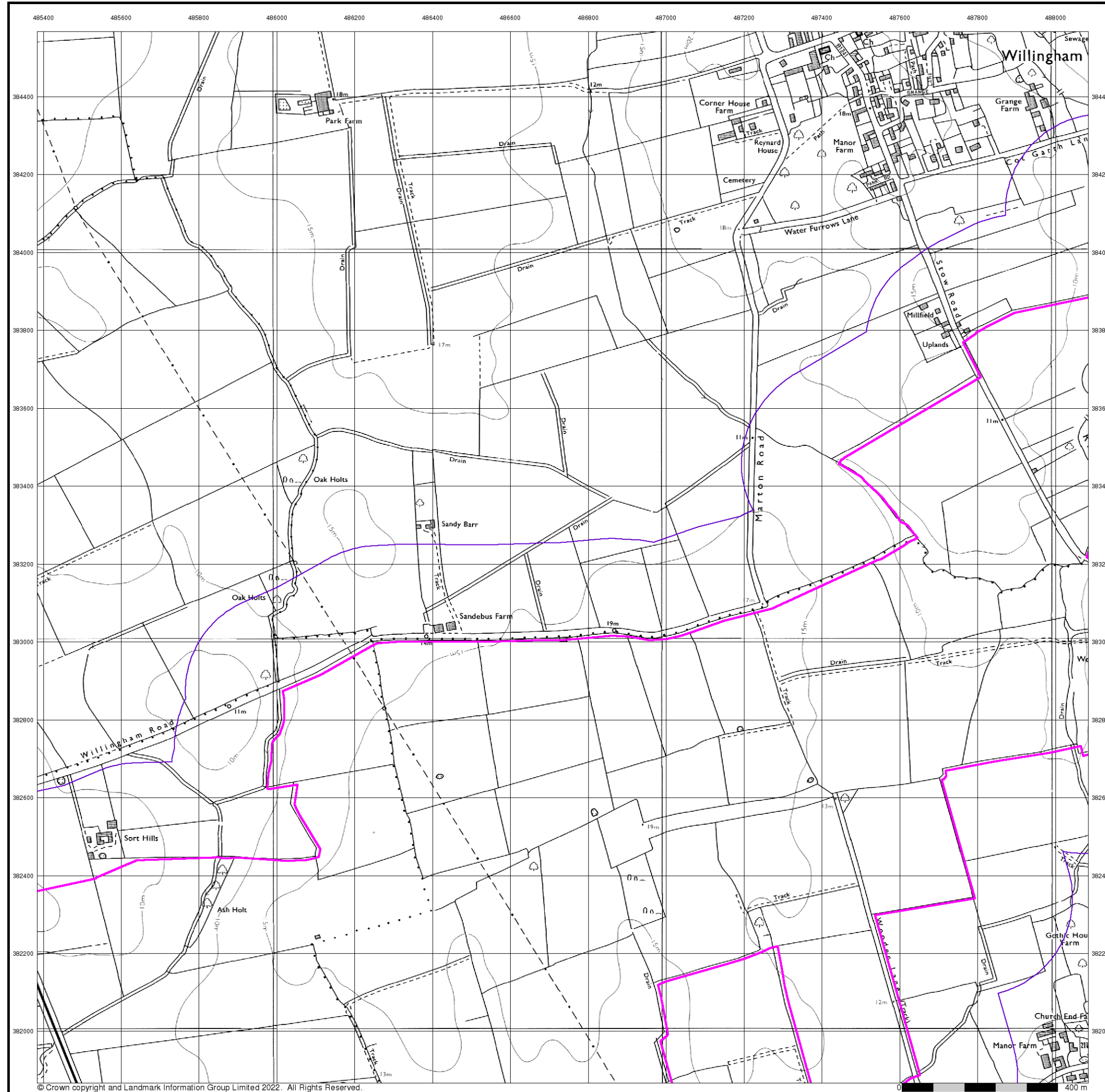

© Crown copyright and Landmark Information Group Limited 2022. All Rights Reserved.



Ordnance Survey Plan
Published 1981
Source map scale - 1:10,000

The historical maps shown were reproduced from maps predominantly held at the scale adopted for England, Wales and Scotland in the 1840's. In 1854 the 1:2,500 scale was adopted for mapping urban areas; these maps were used to update the 1:10,560 maps. The published date given therefore is often some years later than the surveyed date. Before 1938, all OS maps were based on the Cassini Projection, with independent surveys of a single county or group of counties, giving rise to significant inaccuracies in outlying areas. In the late 1940's, a Provisional Edition was produced, which updated the 1:10,560 mapping from a number of sources. The maps appear unfinished - with all military camps and other strategic sites removed. These maps were initially overprinted with the National Grid. In 1970, the first 1:10,000 maps were produced using the Transverse Mercator Projection. The revision process continued until recently, with new editions appearing every 10 years or so for urban areas.

Map Name(s) and Date(s)

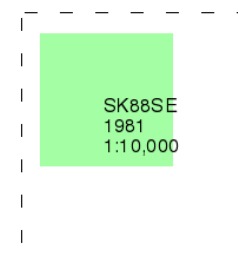

Historical Map - Slice F

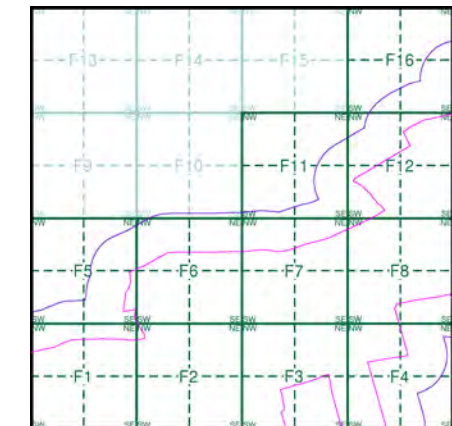

Order Details

Order Number: 297990210_1_1
 Customer Ref: 21-1088.04
 National Grid Reference: 486940, 382710
 Slice: F
 Site Area (Ha): 1120.8
 Search Buffer (m): 250

Site Details

Cottam



Tel: [Redacted]
 Fax: [Redacted]
 Web: [Redacted]

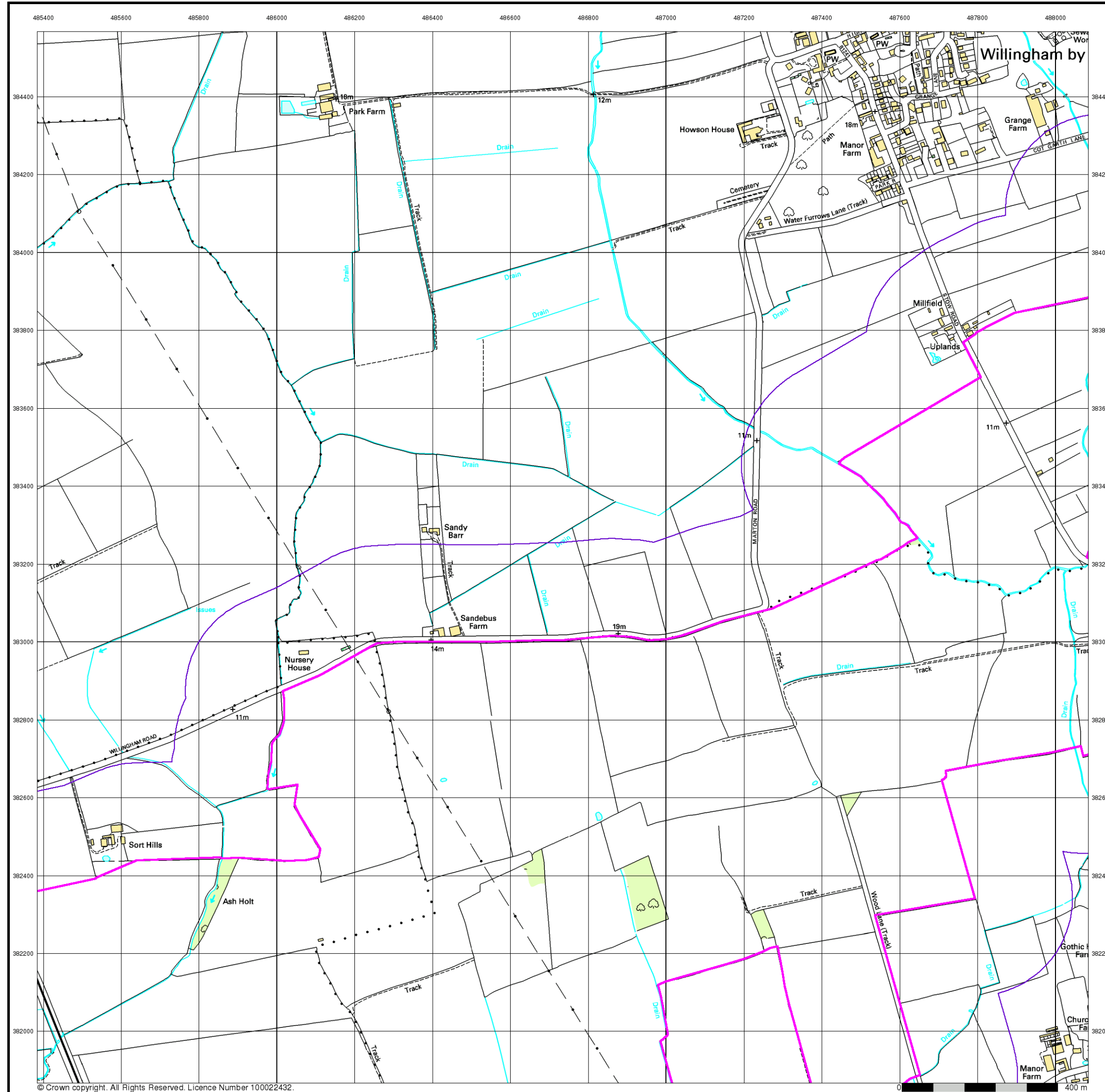

© Crown copyright. All Rights Reserved. Licence Number 100022432.



10k Raster Mapping

Published 2000

Source map scale - 1:10,000

The historical maps shown were produced from the Ordnance Survey's 1:10,000 colour raster mapping. These maps are derived from Landplan which replaced the old 1:10,000 maps originally published in 1970. The data is highly detailed showing buildings, fences and field boundaries as well as all roads, tracks and paths. Road names are also included together with the relevant road number and classification. Boundary information depiction includes county, unitary authority, district, civil parish and constituency.

Map Name(s) and Date(s)

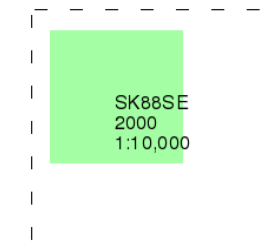

Historical Map - Slice F

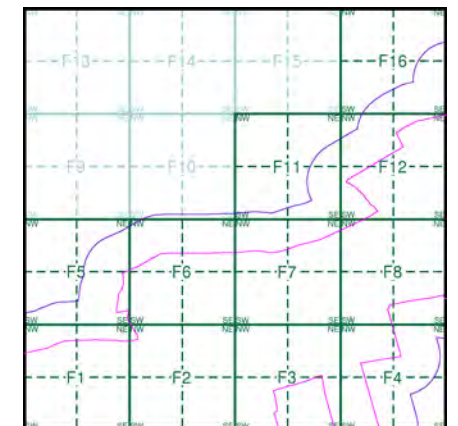

Order Details

Order Number: 297990210_1_1
 Customer Ref: 21-1088.04
 National Grid Reference: 486940, 382710
 Slice: F
 Site Area (Ha): 1120.8
 Search Buffer (m): 250

Site Details

Cottam



Tel: [Redacted]
 Fax: [Redacted]
 Web: [Redacted]

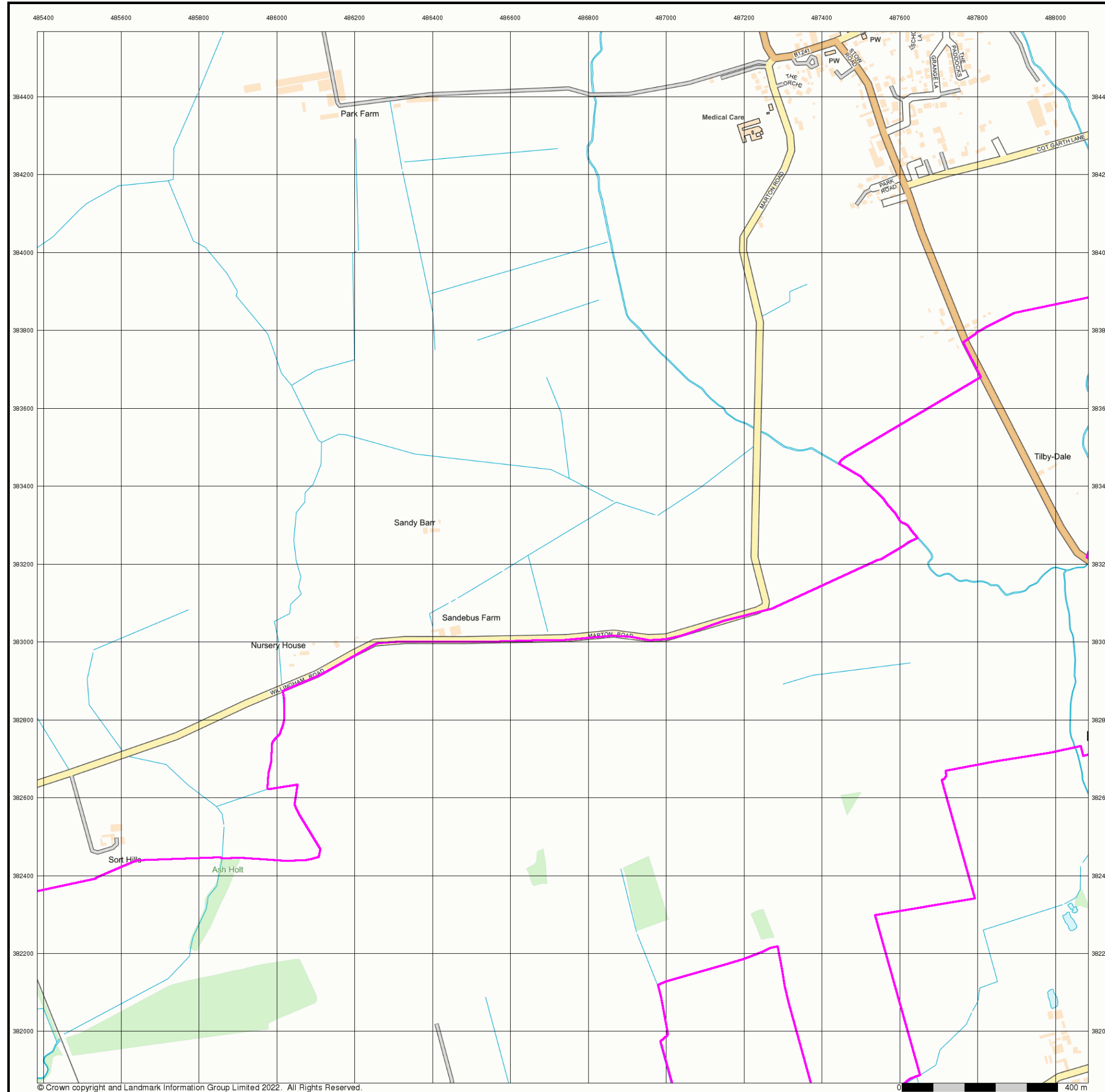

© Crown copyright and Landmark Information Group Limited 2022. All Rights Reserved.



Street View

Published 2022

Source map scale - 1:10,000

Street View is a street-level map for the whole of Great Britain produced by the Ordnance Survey. These maps are provided at a nominal scale of 1:10,000

Map Name(s) and Date(s)



Street View Map - Slice F

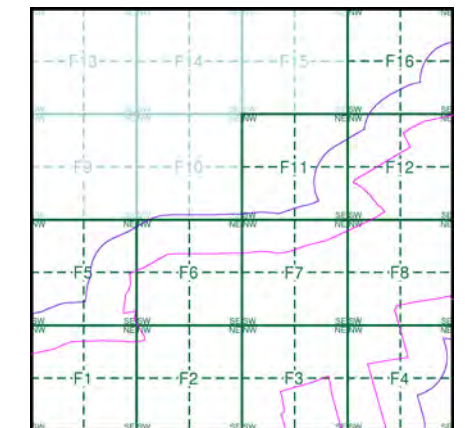

Order Details

Order Number: 297990210_1_1
 Customer Ref: 21-1088.04
 National Grid Reference: 486940, 382710
 Slice: F
 Site Area (Ha): 1120.8
 Search Buffer (m): 250

Site Details

Cottam



Tel: [Redacted]
 Fax: [Redacted]
 Web: [Redacted]

Historical Mapping Legends

Ordnance Survey County Series and Ordnance Survey Plan 1:2,500

Quarry **Gravel Pit** **Sand Pit**
Clay Pit **Shingle** **Refuse Heap**
Sloping Masonry **Flat Rock**
Marsh **Reeds** **Osiers**
Rough Pasture **Furze** **Wood**
Mixed Wood **Brushwood** **Orchard**
Fir **Ford** **Stepping Stones**
Ferry **Waterfall** **Lock**
Trig. Station **Altitude at Trig. Station**
B.M. 325.9 **Bench Mark** **Surface Level**
Arrow denotes flow of water **Antiquities (site of)**
Cutting **Embankment**
Railway crossing Road **Level Crossing** **Road crossing Railway**
Railway crossing River or Canal **Road over single stream** **Road over River or Canal**
County Boundary (Geographical)
County & Civil Parish Boundary
Administrative County & Civil Parish Boundary
County Borough Boundary (England)
Co. Boro. Bdy.
County Burgh Boundary (Scotland)
Co. Burgh Bdy.
BP BS Boundary Post or Stone **P.C.B** Police Call Box
B.R. Bridle Road **P** Pump
E.P Electricity Pylon **S.P** Signal Post
F.B. Foot Bridge **SL** Sluice
F.P. Foot Path **Sp.** Spring
G.P Guide Post or Board **T.C.B** Telephone Call Box
M.S Mile Stone **Tr.** Trough
M.P M.R Mooring Post or Ring **W** Well

Ordnance Survey Plan, Additional SIMs and Supply of Unpublished Survey Information 1:2,500 and 1:1,250

Inactive Quarry, Chalk Pit or Clay Pit **Active Quarry, Chalk Pit or Clay Pit**
Rock **Boulders**
Cliff **Slopes** **Top**
Roofed Building **Glazed Roof Building**
Sloping Masonry **Archway**
Non-Coniferous Tree (surveyed) **Coniferous Tree (surveyed)**
Non-Coniferous Trees (not surveyed) **Coniferous Trees (not surveyed)**
Orchard Tree **Scrub** **Bracken**
Coppice, Osier **Reeds** **Marsh, Saltings**
Rough Grassland **Heath** **Culvert**
Direction of water flow **Bench Mark** **Antiquity (site of)**
Cave Entrance **Triangulation Station** **Electricity Pylon**
Electricity Transmission Line
County Boundary (Geographical)
County & Civil Parish Boundary
Civil Parish Boundary
Admin. County or County Bor. Boundary
London Borough Boundary
Symbol marking point where boundary mereing changes
BH Beer House **P** Pillar, Pole or Post
BP, BS Boundary Post or Stone **PO** Post Office
Cn, C Capstan, Crane **PC** Public Convenience
Chy Chimney **PH** Public House
D Fn Drinking Fountain **Pp** Pump
EI P Electricity Pillar or Post **SB, S Br** Signal Box or Bridge
FAP Fire Alarm Pillar **SP, SL** Signal Post or Light
FB Foot Bridge **Spr** Spring
GP Guide Post **Tk** Tank or Track
H Hydrant or Hydraulic **TCB** Telephone Call Box
LC Level Crossing **TCP** Telephone Call Post
MH Manhole **Tr** Trough
MP Mile Post or Mooring Post **Wr Pt, Wr T** Water Point, Water Tap
MS Mile Stone **W** Well
NTL Normal Tidal Limit **Wd Pp** Wind Pump

Large-Scale National Grid Data 1:2,500 and 1:1,250

Cliff **Slopes** **Top**
Rock **Rock (scattered)**
Boulders **Boulders (scattered)**
Positioned Boulder **Scree**
Non-Coniferous Tree (surveyed) **Coniferous Tree (surveyed)**
Non-Coniferous Trees (not surveyed) **Coniferous Trees (not surveyed)**
Orchard Tree **Scrub** **Bracken**
Coppice, Osier **Reeds** **Marsh, Saltings**
Rough Grassland **Heath** **Culvert**
Direction of water flow **Triangulation Station** **Antiquity (site of)**
Electricity Transmission Line **Electricity Pylon**
B.M. 231.60m Bench Mark **Buildings with Building Seed**
Roofed Building **Glazed Roof Building**
Civil parish/community boundary
District boundary
County boundary
Boundary post/stone
Boundary mereing symbol (note: these always appear in opposed pairs or groups of three)
Bks Barracks **P** Pillar, Pole or Post
Bty Battery **PO** Post Office
Cemy Cemetery **PC** Public Convenience
Chy Chimney **Pp** Pump
Cis Cistern **Ppg Sta** Pumping Station
Dismtd Rly Dismantled Railway **PW** Place of Worship
EI Gen Sta Electricity Generating Station **Sewage Ppg Sta** Sewage Pumping Station
EI P Electricity Pole, Pillar **SB, S Br** Signal Box or Bridge
EI Sub Sta Electricity Sub Station **SP, SL** Signal Post or Light
FB Filter Bed **Spr** Spring
Fn / D Fn Fountain / Drinking Ftn. **Tk** Tank or Track
Gas Gov Gas Valve Compound **Tr** Trough
GVC Gas Governor **Wd Pp** Wind Pump
GP Guide Post **Wr Pt, Wr T** Water Point, Water Tap
MH Manhole **Wks** Works (building or area)
MP, MS Mile Post or Mile Stone **W** Well



Historical Mapping & Photography included:

Mapping Type	Scale	Date	Pg
Lincolnshire	1:2,500	1886	2
Lincolnshire	1:2,500	1906	3
Lincolnshire	1:2,500	1920	4
Ordnance Survey Plan	1:2,500	1974 - 1976	5
Large-Scale National Grid Data	1:2,500	1994	6

Historical Map - Segment F1

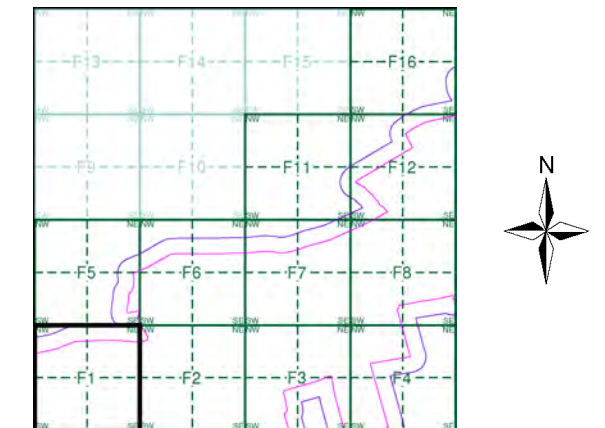

Order Details

Order Number: 297990210_1_1
 Customer Ref: 21-1088.04
 National Grid Reference: 486940, 382710
 Slice: F
 Site Area (Ha): 1120.8
 Search Buffer (m): 100

Site Details

Cottam



Tel: [Redacted]
 Fax: [Redacted]
 Web: [Redacted]

Lincolnshire
Published 1886

Source map scale - 1:2,500

The historical maps shown were reproduced from maps predominantly held at the scale adopted for England, Wales and Scotland in the 1840's. In 1854 the 1:2,500 scale was adopted for mapping urban areas and by 1896 it covered the whole of what were considered to be the cultivated parts of Great Britain. The published date given below is often some years later than the surveyed date. Before 1938, all OS maps were based on the Cassini Projection, with independent surveys of a single county or group of counties, giving rise to significant inaccuracies in outlying areas.

Map Name(s) and Date(s)

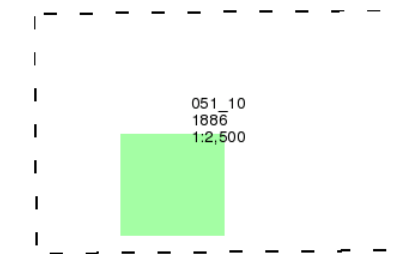

Historical Map - Segment F1

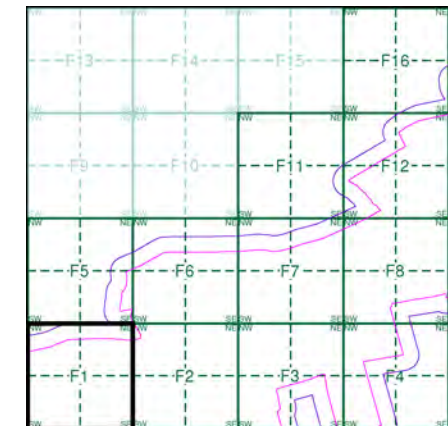

Order Details

Order Number: 297990210_1_1
 Customer Ref: 21-1088.04
 National Grid Reference: 486940, 382710
 Slice: F
 Site Area (Ha): 1120.8
 Search Buffer (m): 100

Site Details

Cottam

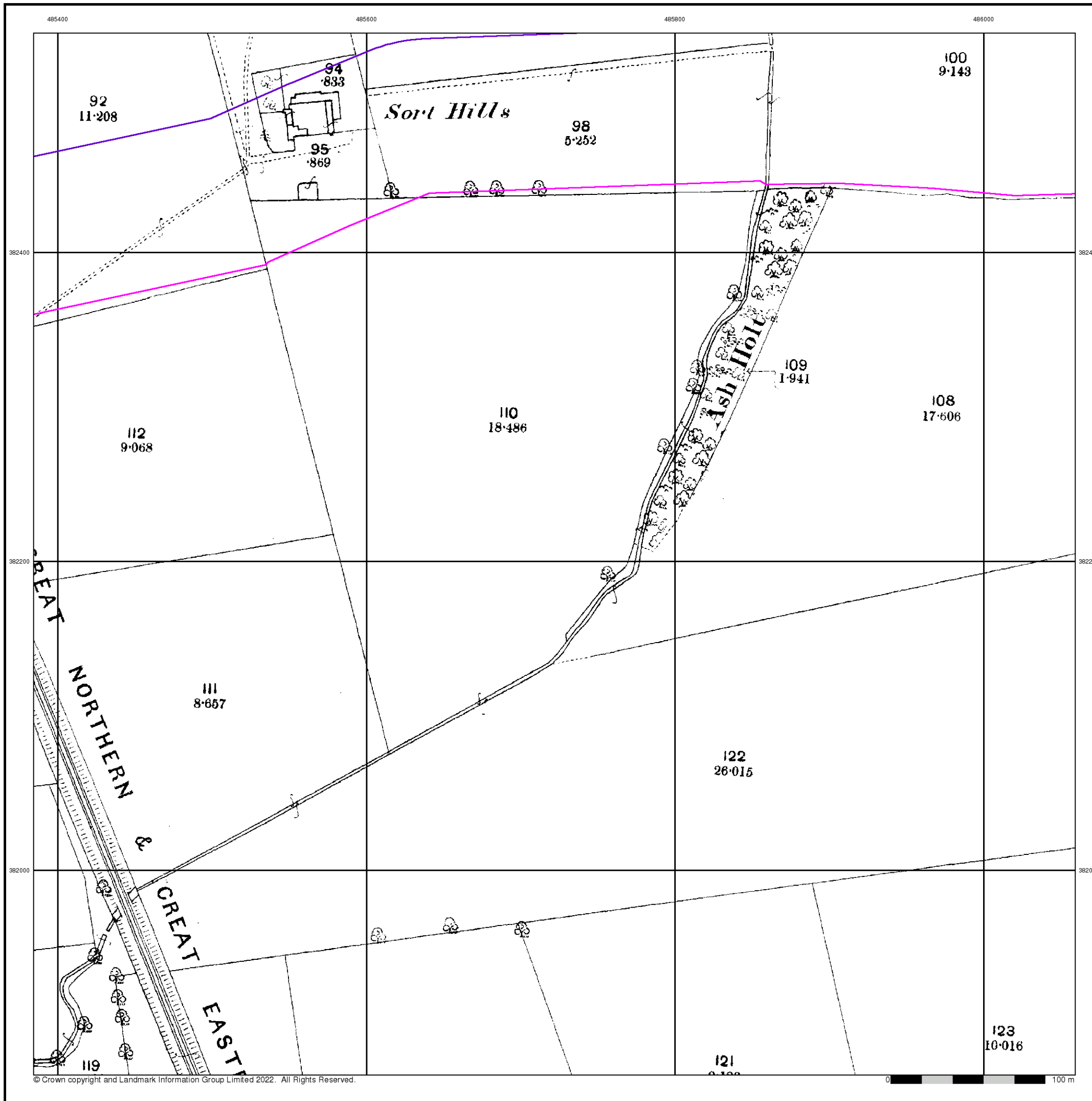

Lincolnshire
Published 1906

Source map scale - 1:2,500

The historical maps shown were reproduced from maps predominantly held at the scale adopted for England, Wales and Scotland in the 1840's. In 1854 the 1:2,500 scale was adopted for mapping urban areas and by 1896 it covered the whole of what were considered to be the cultivated parts of Great Britain. The published date given below is often some years later than the surveyed date. Before 1938, all OS maps were based on the Cassini Projection, with independent surveys of a single county or group of counties, giving rise to significant inaccuracies in outlying areas.

Map Name(s) and Date(s)

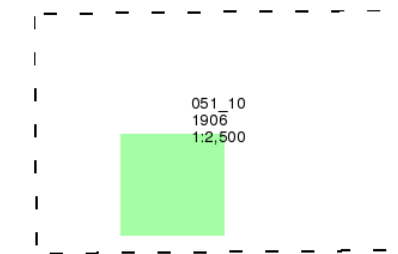

Historical Map - Segment F1

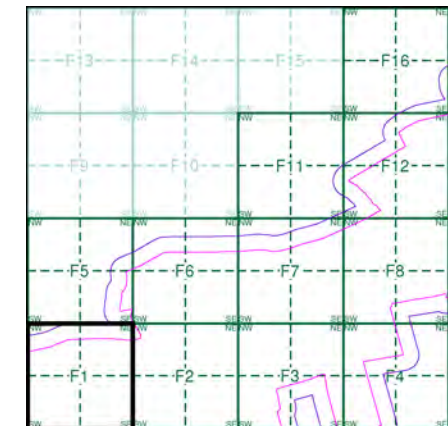

Order Details

Order Number: 297990210_1_1
 Customer Ref: 21-1088.04
 National Grid Reference: 486940, 382710
 Slice: F
 Site Area (Ha): 1120.8
 Search Buffer (m): 100

Site Details

Cottam

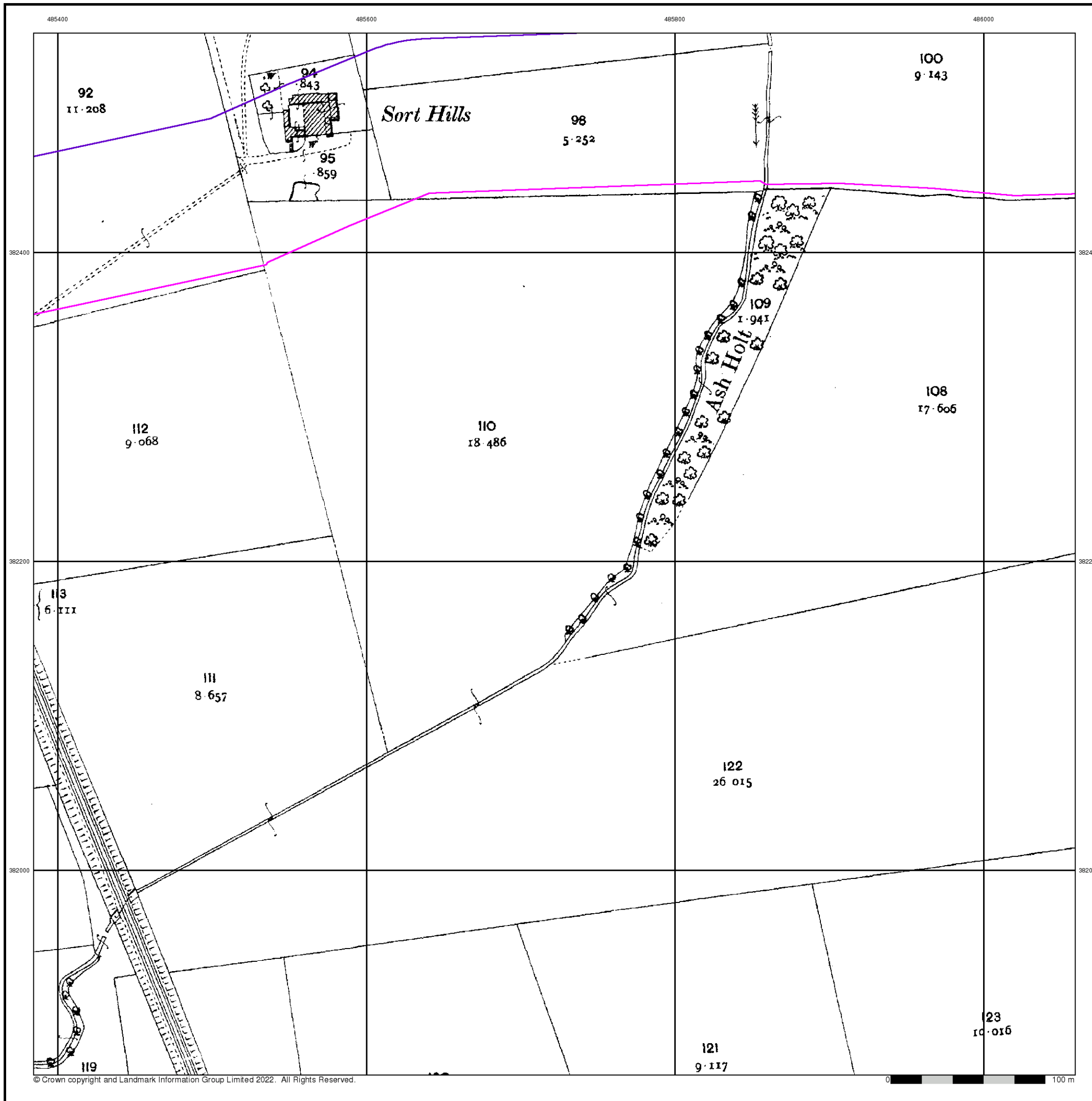

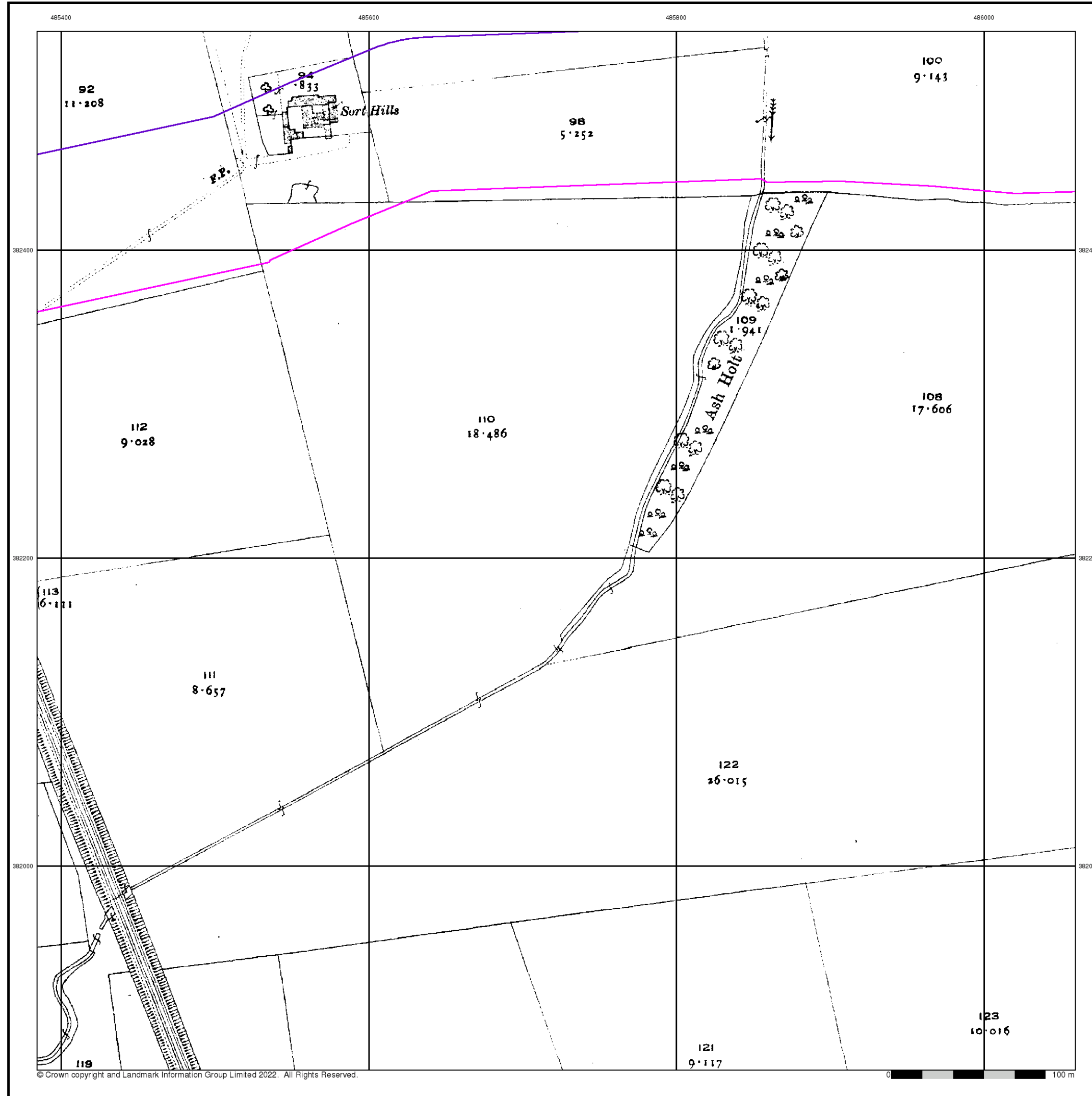

Lincolnshire

Published 1920

Source map scale - 1:2,500

The historical maps shown were reproduced from maps predominantly held at the scale adopted for England, Wales and Scotland in the 1840's. In 1854 the 1:2,500 scale was adopted for mapping urban areas and by 1896 it covered the whole of what were considered to be the cultivated parts of Great Britain. The published date given below is often some years later than the surveyed date. Before 1938, all OS maps were based on the Cassini Projection, with independent surveys of a single county or group of counties, giving rise to significant inaccuracies in outlying areas.

Map Name(s) and Date(s)

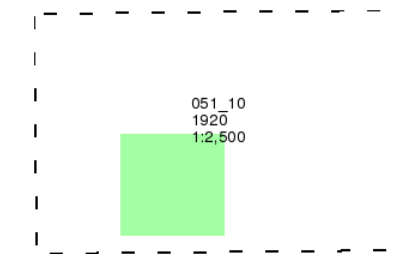

Historical Map - Segment F1

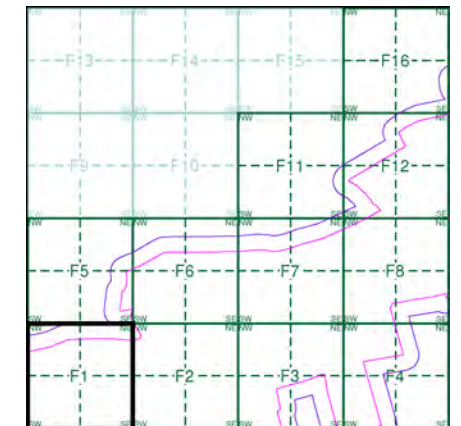

Order Details

Order Number: 297990210_1_1
 Customer Ref: 21-1088.04
 National Grid Reference: 486940, 382710
 Slice: F
 Site Area (Ha): 1120.8
 Search Buffer (m): 100

Site Details

Cottam



Tel: [Redacted]
 Fax: [Redacted]
 Web: [Redacted]

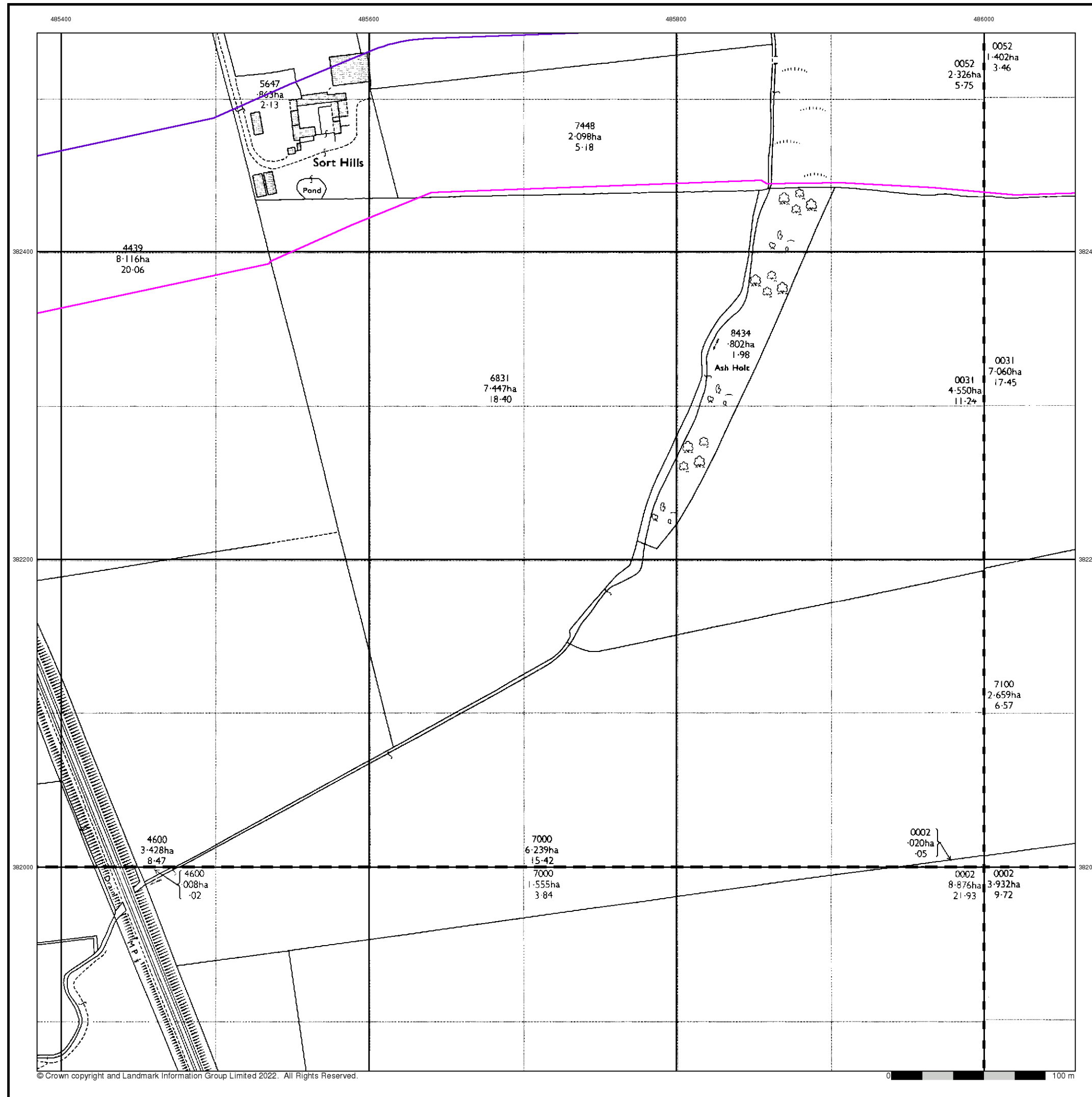

Ordnance Survey Plan
Published 1974 - 1976
Source map scale - 1:2,500

The historical maps shown were reproduced from maps predominantly held at the scale adopted for England, Wales and Scotland in the 1840's. In 1854 the 1:2,500 scale was adopted for mapping urban areas and by 1896 it covered the whole of what were considered to be the cultivated parts of Great Britain. The published date given below is often some years later than the surveyed date. Before 1938, all OS maps were based on the Cassini Projection, with independent surveys of a single county or group of counties, giving rise to significant inaccuracies in outlying areas.

Map Name(s) and Date(s)

SK8582 1975 1:2,500	SK8682 1975 1:2,500
SK8581 1974 1:2,500	SK8681 1976 1:2,500

Historical Map - Segment F1

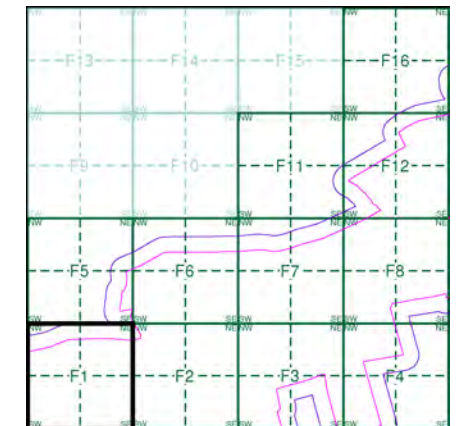

Order Details

Order Number: 297990210_1_1
 Customer Ref: 21-1088.04
 National Grid Reference: 486940, 382710
 Slice: F
 Site Area (Ha): 1120.8
 Search Buffer (m): 100

Site Details

Cottam



Tel: [Redacted]
 Fax: [Redacted]
 Web: [Redacted]

Historical Mapping Legends

Ordnance Survey County Series and Ordnance Survey Plan 1:2,500

Quarry **Gravel Pit** **Sand Pit**
Clay Pit **Shingle** **Refuse Heap**
Sloping Masonry **Flat Rock**
Marsh **Reeds** **Osiers**
Rough Pasture **Furze** **Wood**
Mixed Wood **Brushwood** **Orchard**
Fir **Ford** **Stepping Stones**
Ferry **Waterfall** **Lock**
Trig. Station **Altitude at Trig. Station**
B.M. 325.9 **Bench Mark** **Surface Level**
Arrow denotes flow of water **Antiquities (site of)**
Cutting **Embankment**
Railway crossing Road **Level Crossing** **Road crossing Railway**
Railway crossing River or Canal **Road over single stream** **Road over River or Canal**
County Boundary (Geographical)
County & Civil Parish Boundary
Administrative County & Civil Parish Boundary
County Borough Boundary (England)
Co. Boro. Bdy.
County Burgh Boundary (Scotland)
Co. Burgh Bdy.
BP BS Boundary Post or Stone **P.C.B** Police Call Box
B.R. Bridle Road **P** Pump
E.P Electricity Pylon **S.P** Signal Post
F.B. Foot Bridge **SL** Sluice
F.P. Foot Path **Sp.** Spring
G.P Guide Post or Board **T.C.B** Telephone Call Box
M.S Mile Stone **Tr.** Trough
M.P M.R Mooring Post or Ring **W** Well

Ordnance Survey Plan, Additional SIMs and Supply of Unpublished Survey Information 1:2,500 and 1:1,250

Inactive Quarry, Chalk Pit or Clay Pit **Active Quarry, Chalk Pit or Clay Pit**
Rock **Boulders**
Cliff **Slopes** **Top**
Roofed Building **Glazed Roof Building**
Sloping Masonry **Archway**
Non-Coniferous Tree (surveyed) **Coniferous Tree (surveyed)**
Non-Coniferous Trees (not surveyed) **Coniferous Trees (not surveyed)**
Orchard Tree **Scrub** **Bracken**
Coppice, Osier **Reeds** **Marsh, Saltings**
Rough Grassland **Heath** **Culvert**
Direction of water flow **Bench Mark** **Antiquity (site of)**
Cave Entrance **Triangulation Station** **Electricity Pylon**
Electricity Transmission Line
County Boundary (Geographical)
County & Civil Parish Boundary
Civil Parish Boundary
Admin. County or County Bor. Boundary
London Borough Boundary
Symbol marking point where boundary mereing changes
BH Beer House **P** Pillar, Pole or Post
BP, BS Boundary Post or Stone **PO** Post Office
Cn, C Capstan, Crane **PC** Public Convenience
Chy Chimney **PH** Public House
D Fn Drinking Fountain **Pp** Pump
EI P Electricity Pillar or Post **SB, S Br** Signal Box or Bridge
FAP Fire Alarm Pillar **SP, SL** Signal Post or Light
FB Foot Bridge **Spr** Spring
GP Guide Post **Tk** Tank or Track
H Hydrant or Hydraulic **TCB** Telephone Call Box
LC Level Crossing **TCP** Telephone Call Post
MH Manhole **Tr** Trough
MP Mile Post or Mooring Post **Wr Pt, Wr T** Water Point, Water Tap
MS Mile Stone **W** Well
NTL Normal Tidal Limit **Wd Pp** Wind Pump

Large-Scale National Grid Data 1:2,500 and 1:1,250

Cliff **Slopes** **Top**
Rock **Rock (scattered)**
Boulders **Boulders (scattered)**
Positioned Boulder **Scree**
Non-Coniferous Tree (surveyed) **Coniferous Tree (surveyed)**
Non-Coniferous Trees (not surveyed) **Coniferous Trees (not surveyed)**
Orchard Tree **Scrub** **Bracken**
Coppice, Osier **Reeds** **Marsh, Saltings**
Rough Grassland **Heath** **Culvert**
Direction of water flow **Triangulation Station** **Antiquity (site of)**
Electricity Transmission Line **Electricity Pylon**
B.M. 231.60m Bench Mark **Buildings with Building Seed**
Roofed Building **Glazed Roof Building**
Civil parish/community boundary
District boundary
County boundary
Boundary post/stone
Boundary mereing symbol (note: these always appear in opposed pairs or groups of three)
Bks Barracks **P** Pillar, Pole or Post
Bty Battery **PO** Post Office
Cemy Cemetery **PC** Public Convenience
Chy Chimney **Pp** Pump
Cis Cistern **Ppg Sta** Pumping Station
Dismtd Rly Dismantled Railway **PW** Place of Worship
EI Gen Sta Electricity Generating Station **Sewage Ppg Sta** Sewage Pumping Station
EI P Electricity Pole, Pillar **SB, S Br** Signal Box or Bridge
EI Sub Sta Electricity Sub Station **SP, SL** Signal Post or Light
FB Filter Bed **Spr** Spring
Fn / D Fn Fountain / Drinking Ftn. **Tk** Tank or Track
Gas Gov Gas Valve Compound **Tr** Trough
GVC Gas Governor **Wd Pp** Wind Pump
GP Guide Post **Wr Pt, Wr T** Water Point, Water Tap
MH Manhole **Wks** Works (building or area)
MP, MS Mile Post or Mile Stone **W** Well



Historical Mapping & Photography included:

Mapping Type	Scale	Date	Pg
Lincolnshire	1:2,500	1886	2
Lincolnshire	1:2,500	1906	3
Lincolnshire	1:2,500	1920	4
Ordnance Survey Plan	1:2,500	1975 - 1976	5
Large-Scale National Grid Data	1:2,500	1994	6

Historical Map - Segment F2

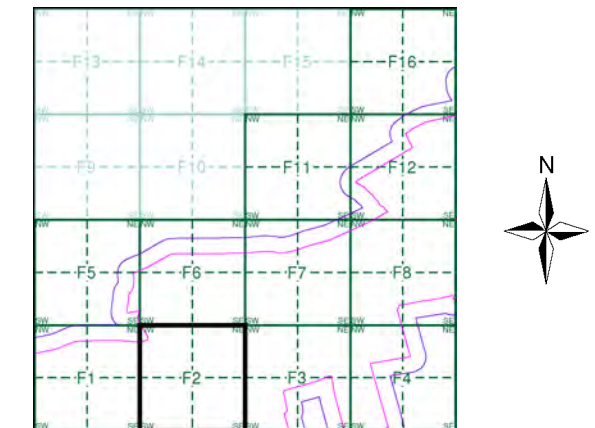

Order Details

Order Number: 297990210_1_1
 Customer Ref: 21-1088.04
 National Grid Reference: 486940, 382710
 Slice: F
 Site Area (Ha): 1120.8
 Search Buffer (m): 100

Site Details

Cottam



Tel: [Redacted]
 Fax: [Redacted]
 Web: [Redacted]

Lincolnshire

Published 1886

Source map scale - 1:2,500

The historical maps shown were reproduced from maps predominantly held at the scale adopted for England, Wales and Scotland in the 1840's. In 1854 the 1:2,500 scale was adopted for mapping urban areas and by 1896 it covered the whole of what were considered to be the cultivated parts of Great Britain. The published date given below is often some years later than the surveyed date. Before 1938, all OS maps were based on the Cassini Projection, with independent surveys of a single county or group of counties, giving rise to significant inaccuracies in outlying areas.

Map Name(s) and Date(s)

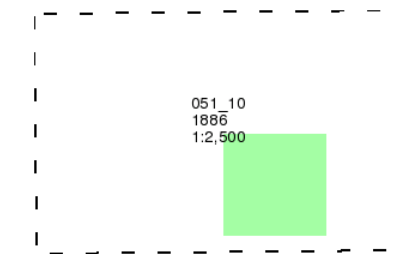

Historical Map - Segment F2

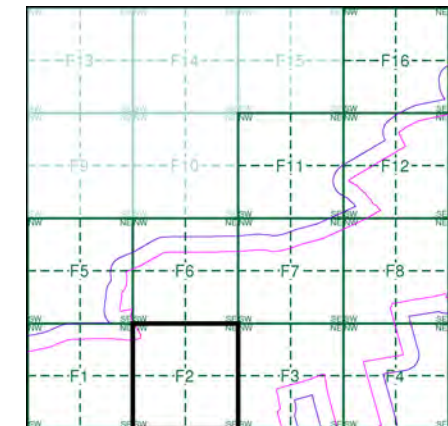

Order Details

Order Number: 297990210_1_1
 Customer Ref: 21-1088.04
 National Grid Reference: 486940, 382710
 Slice: F
 Site Area (Ha): 1120.8
 Search Buffer (m): 100

Site Details

Cottam

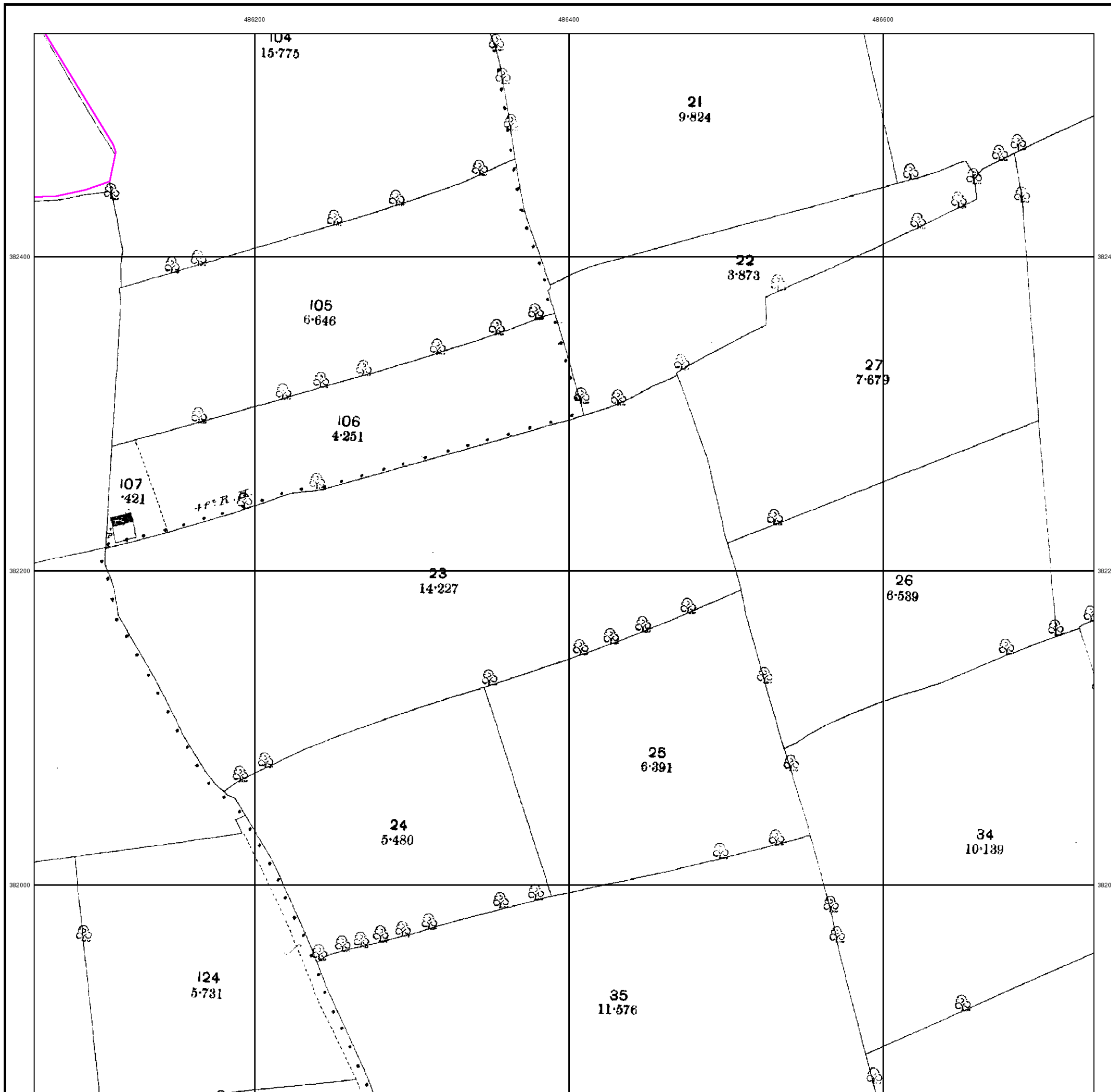

Lincolnshire

Published 1906

Source map scale - 1:2,500

The historical maps shown were reproduced from maps predominantly held at the scale adopted for England, Wales and Scotland in the 1840's. In 1854 the 1:2,500 scale was adopted for mapping urban areas and by 1896 it covered the whole of what were considered to be the cultivated parts of Great Britain. The published date given below is often some years later than the surveyed date. Before 1938, all OS maps were based on the Cassini Projection, with independent surveys of a single county or group of counties, giving rise to significant inaccuracies in outlying areas.

Map Name(s) and Date(s)

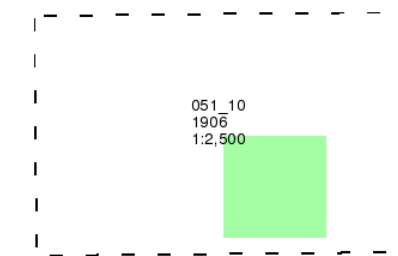

Historical Map - Segment F2

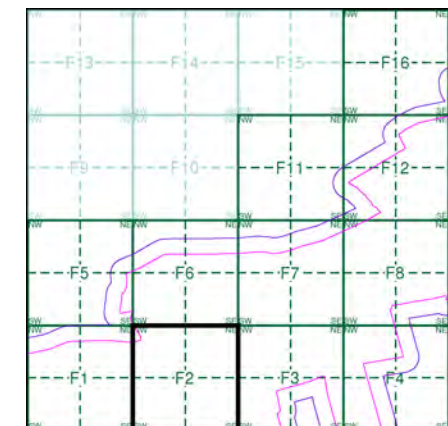

Order Details

Order Number: 297990210_1_1
 Customer Ref: 21-1088.04
 National Grid Reference: 486940, 382710
 Slice: F
 Site Area (Ha): 1120.8
 Search Buffer (m): 100

Site Details

Cottam

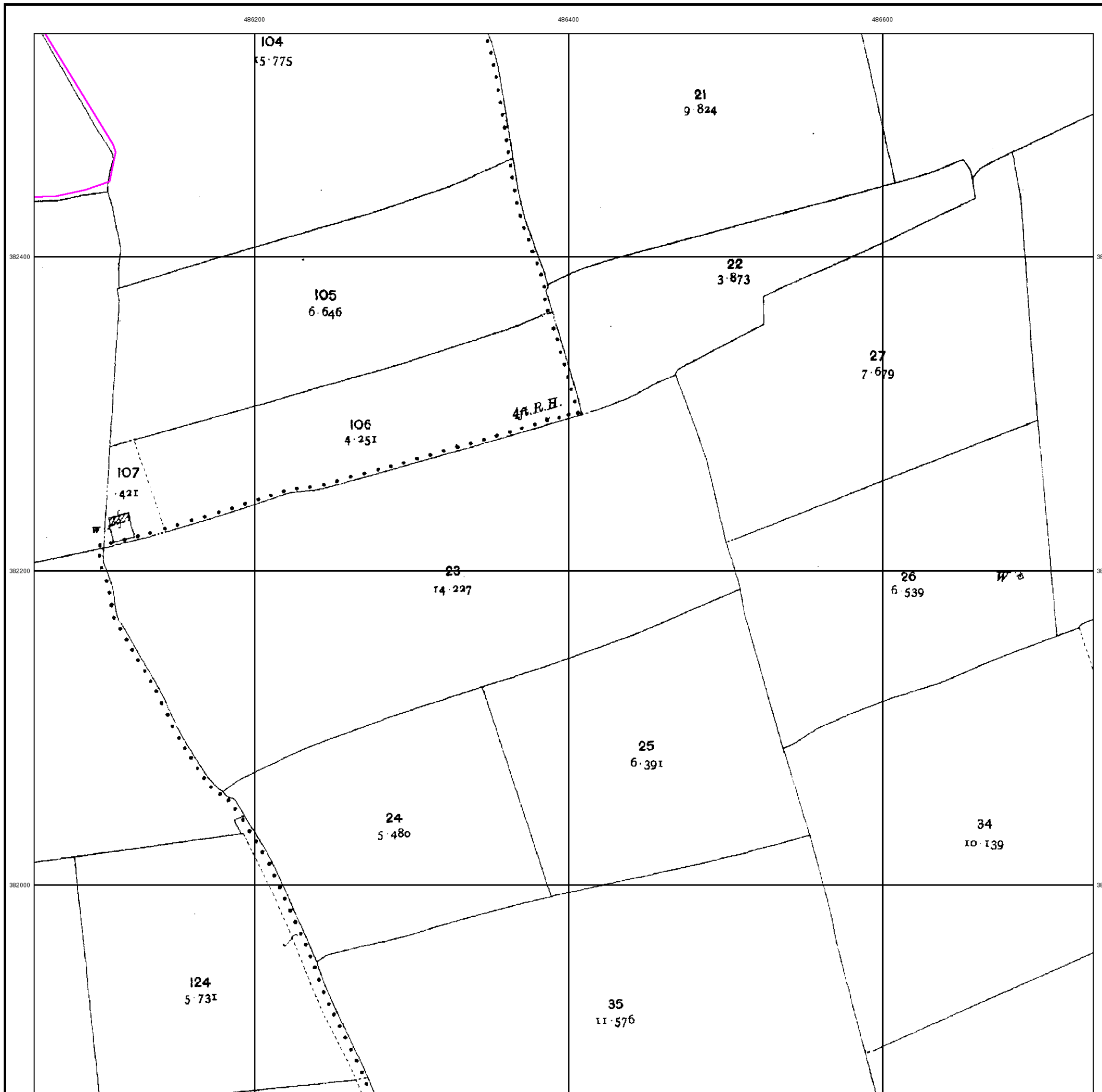

Lincolnshire

Published 1920

Source map scale - 1:2,500

The historical maps shown were reproduced from maps predominantly held at the scale adopted for England, Wales and Scotland in the 1840's. In 1854 the 1:2,500 scale was adopted for mapping urban areas and by 1896 it covered the whole of what were considered to be the cultivated parts of Great Britain. The published date given below is often some years later than the surveyed date. Before 1938, all OS maps were based on the Cassini Projection, with independent surveys of a single county or group of counties, giving rise to significant inaccuracies in outlying areas.

Map Name(s) and Date(s)

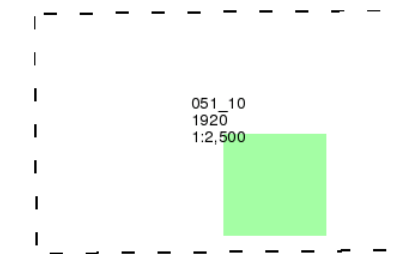

Historical Map - Segment F2

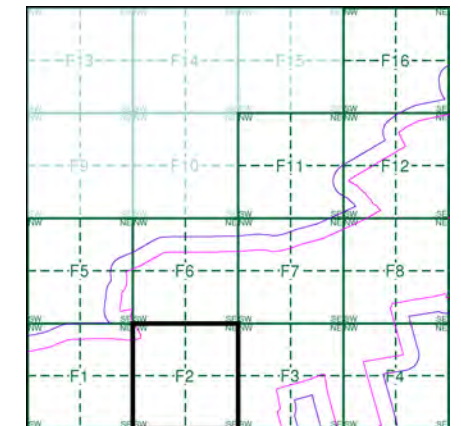

Order Details

Order Number: 297990210_1_1
 Customer Ref: 21-1088.04
 National Grid Reference: 486940, 382710
 Slice: F
 Site Area (Ha): 1120.8
 Search Buffer (m): 100

Site Details

Cottam

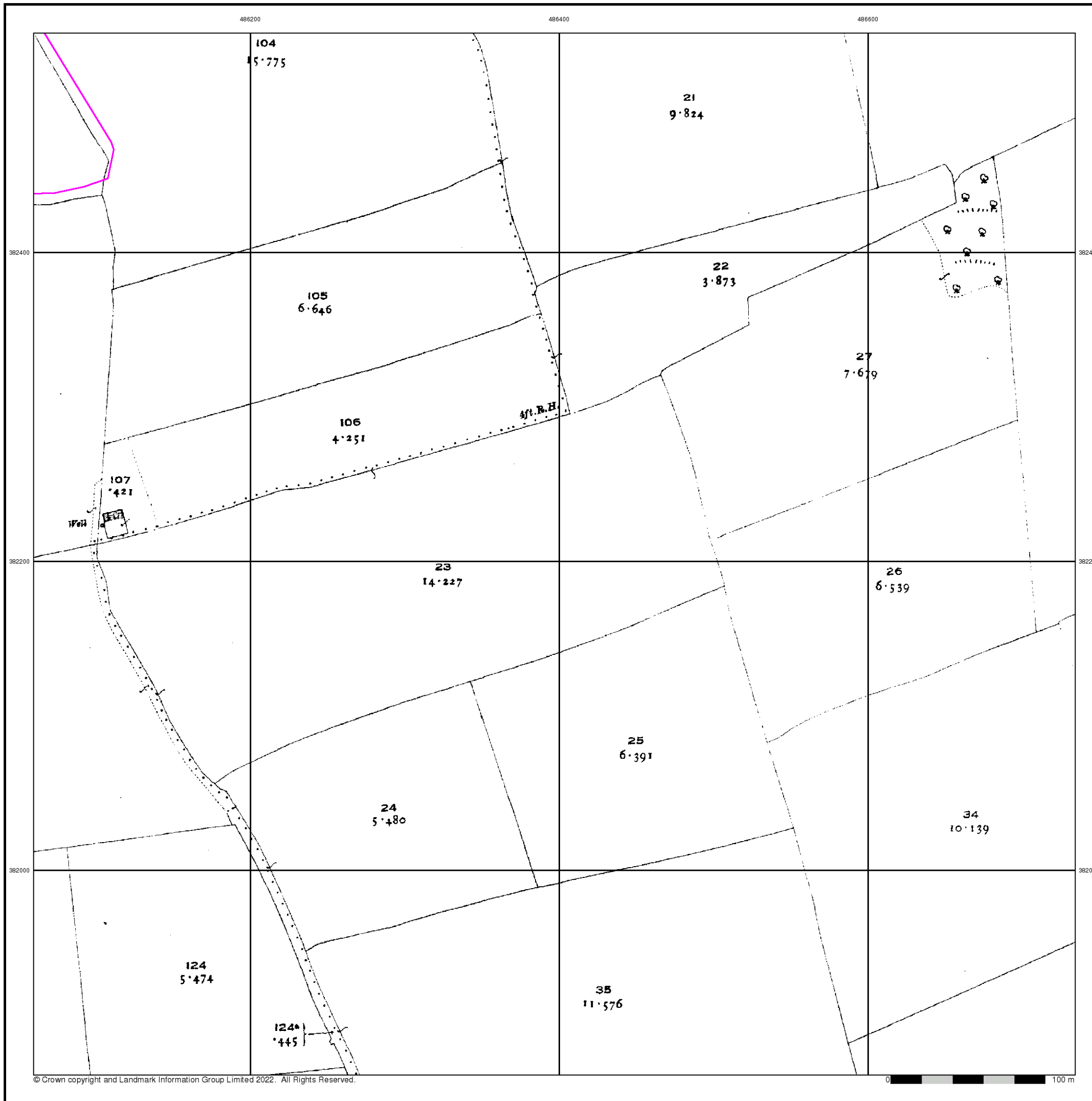

Ordnance Survey Plan
Published 1975 - 1976
Source map scale - 1:2,500

The historical maps shown were reproduced from maps predominantly held at the scale adopted for England, Wales and Scotland in the 1840's. In 1854 the 1:2,500 scale was adopted for mapping urban areas and by 1896 it covered the whole of what were considered to be the cultivated parts of Great Britain. The published date given below is often some years later than the surveyed date. Before 1938, all OS maps were based on the Cassini Projection, with independent surveys of a single county or group of counties, giving rise to significant inaccuracies in outlying areas.

Map Name(s) and Date(s)

SK8682	1975	1:2,500
SK8681	1976	1:2,500

Historical Map - Segment F2

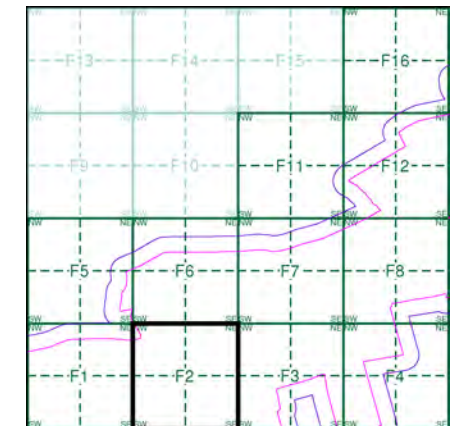

Order Details

Order Number: 297990210_1_1
 Customer Ref: 21-1088.04
 National Grid Reference: 486940, 382710
 Slice: F
 Site Area (Ha): 1120.8
 Search Buffer (m): 100

Site Details

Cottam

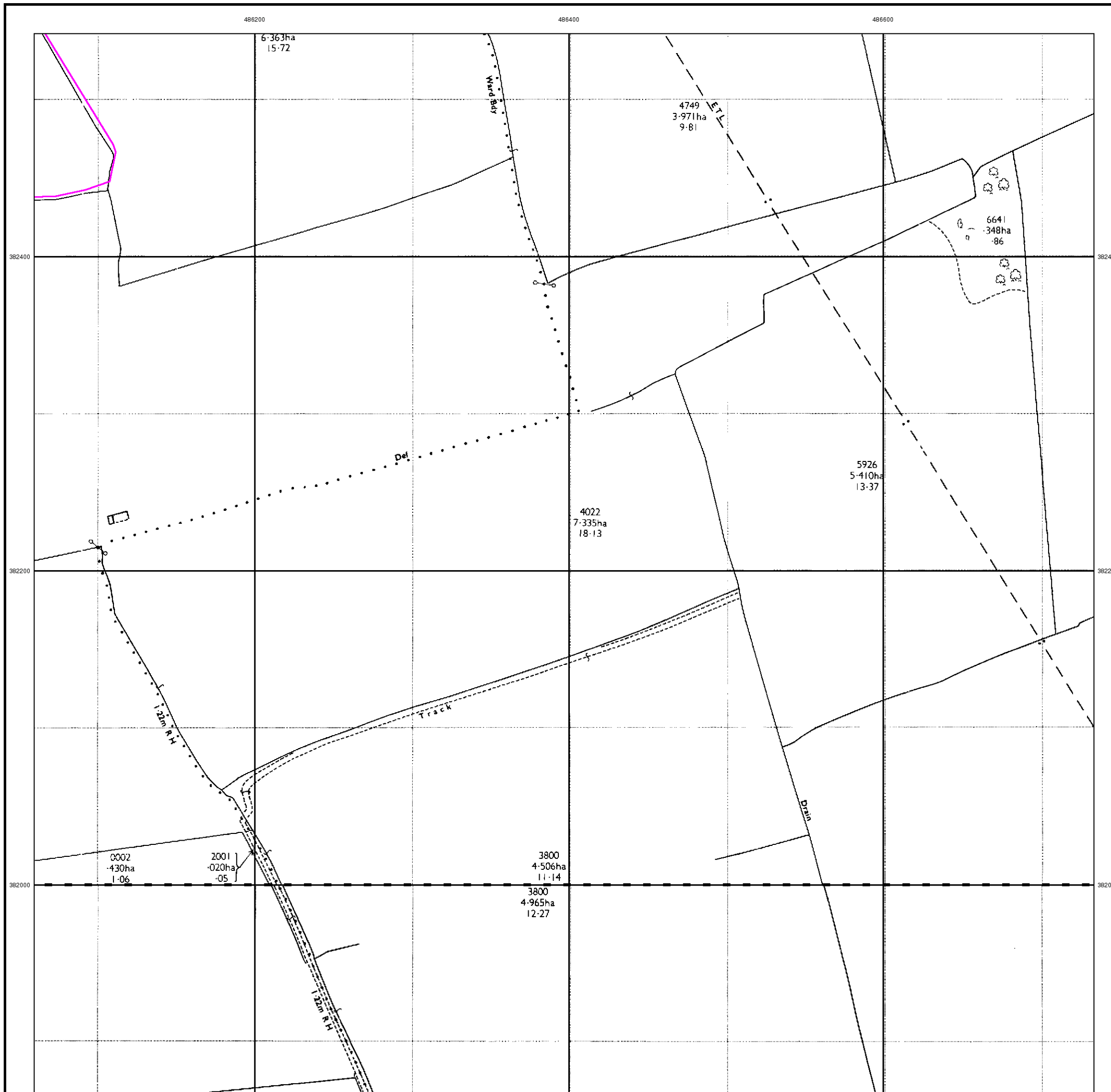

Large-Scale National Grid Data

Published 1994

Source map scale - 1:2,500

'Large Scale National Grid Data' superseded SIM cards (Ordnance Survey's 'Survey of Information on Microfilm') in 1992, and continued to be produced until 1999. These maps were the fore-runners of digital mapping and so provide detailed information on houses and roads, but tend to show less topographic features such as vegetation. These maps were produced at both 1:2,500 and 1:1,250 scales.

Map Name(s) and Date(s)

SK8682	1994	1:2,500
SK8681	1994	1:2,500

Historical Map - Segment F2

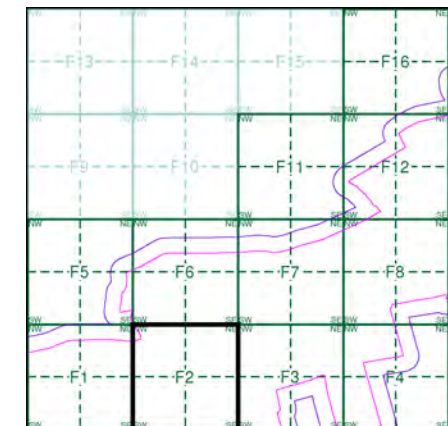

Order Details

Order Number: 297990210_1_1
 Customer Ref: 21-1088.04
 National Grid Reference: 486940, 382710
 Slice: F
 Site Area (Ha): 1120.8
 Search Buffer (m): 100

Site Details

Cottam

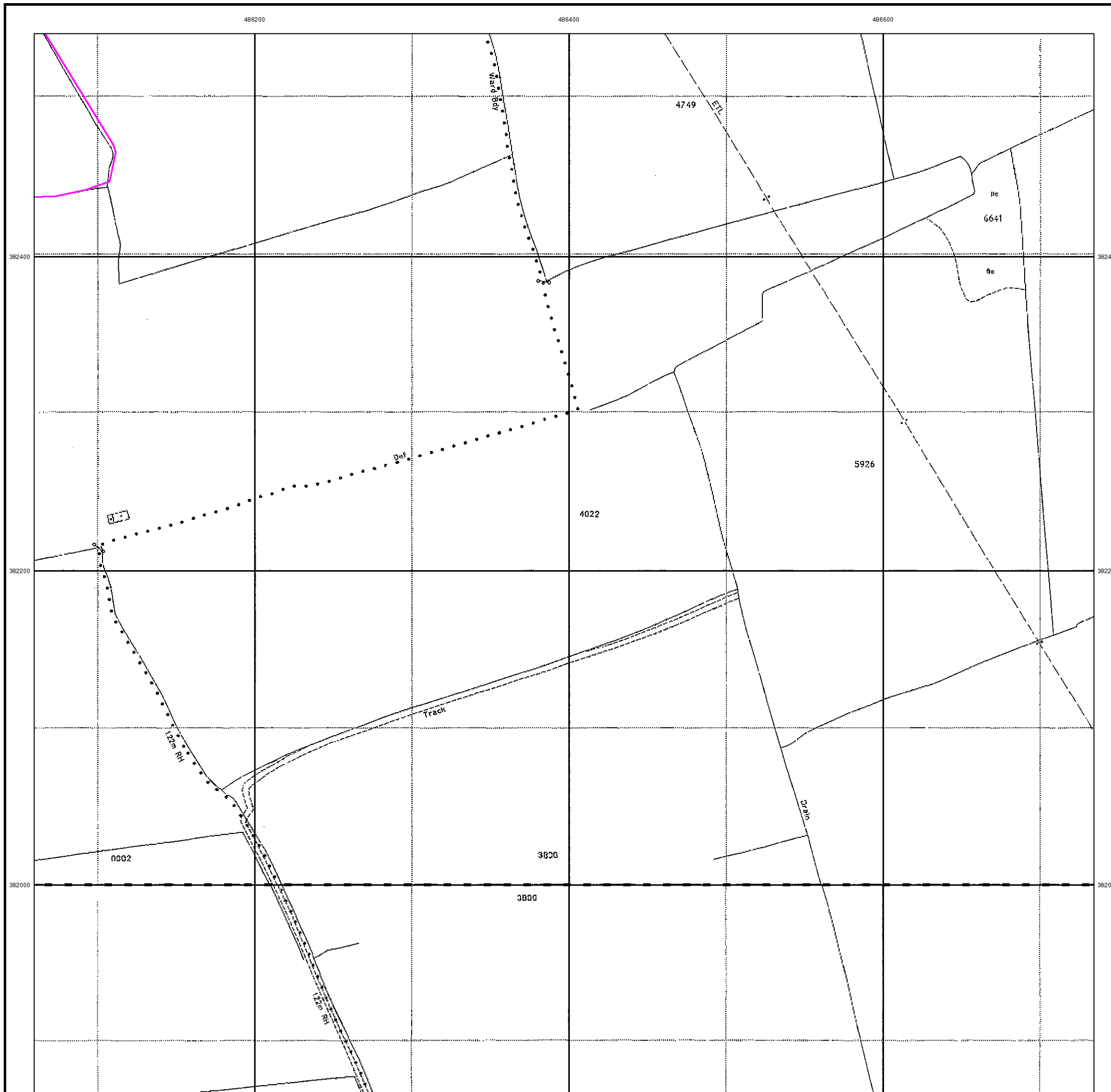

Historical Mapping Legends

Ordnance Survey County Series and Ordnance Survey Plan 1:2,500

Quarry **Gravel Pit** **Sand Pit**
Clay Pit **Shingle** **Refuse Heap**
Sloping Masonry **Flat Rock**
Marsh **Reeds** **Osiers**
Rough Pasture **Furze** **Wood**
Mixed Wood **Brushwood** **Orchard**
Fir **Ford** **Stepping Stones**
Ferry **Waterfall** **Lock**
Trig. Station **Altitude at Trig. Station**
B.M. 325.9 **Bench Mark** **Surface Level**
Arrow denotes flow of water **Antiquities (site of)**
Cutting **Embankment**
Railway crossing Road **Level Crossing** **Road crossing Railway**
Railway crossing River or Canal **Road over single stream** **Road over River or Canal**
County Boundary (Geographical)
County & Civil Parish Boundary
Administrative County & Civil Parish Boundary
County Borough Boundary (England)
Co. Boro. Bdy.
County Burgh Boundary (Scotland)
Co. Burgh Bdy.
BP BS Boundary Post or Stone **P.C.B** Police Call Box
B.R. Bridle Road **P** Pump
E.P Electricity Pylon **S.P** Signal Post
F.B. Foot Bridge **SL** Sluice
F.P. Foot Path **Sp.** Spring
G.P Guide Post or Board **T.C.B** Telephone Call Box
M.S Mile Stone **Tr.** Trough
M.P M.R Mooring Post or Ring **W** Well

Ordnance Survey Plan, Additional SIMs and Supply of Unpublished Survey Information 1:2,500 and 1:1,250

Inactive Quarry, Chalk Pit or Clay Pit **Active Quarry, Chalk Pit or Clay Pit**
Rock **Boulders**
Cliff **Slopes** **Top**
Roofed Building **Glazed Roof Building**
Sloping Masonry **Archway**
Non-Coniferous Tree (surveyed) **Coniferous Tree (surveyed)**
Non-Coniferous Trees (not surveyed) **Coniferous Trees (not surveyed)**
Orchard Tree **Scrub** **Bracken**
Coppice, Osier **Reeds** **Marsh, Saltings**
Rough Grassland **Heath** **Culvert**
Direction of water flow **Bench Mark** **Antiquity (site of)**
Cave Entrance **Triangulation Station** **Electricity Pylon**
Electricity Transmission Line
County Boundary (Geographical)
County & Civil Parish Boundary
Civil Parish Boundary
Admin. County or County Bor. Boundary
London Borough Boundary
Symbol marking point where boundary mereing changes
BH Beer House **P** Pillar, Pole or Post
BP, BS Boundary Post or Stone **PO** Post Office
Cn, C Capstan, Crane **PC** Public Convenience
Chy Chimney **PH** Public House
D Fn Drinking Fountain **Pp** Pump
EI P Electricity Pillar or Post **SB, S Br** Signal Box or Bridge
FAP Fire Alarm Pillar **SP, SL** Signal Post or Light
FB Foot Bridge **Spr** Spring
GP Guide Post **Tk** Tank or Track
H Hydrant or Hydraulic **TCB** Telephone Call Box
LC Level Crossing **TCP** Telephone Call Post
MH Manhole **Tr** Trough
MP Mile Post or Mooring Post **Wr Pt, Wr T** Water Point, Water Tap
MS Mile Stone **W** Well
NTL Normal Tidal Limit **Wd Pp** Wind Pump

Large-Scale National Grid Data 1:2,500 and 1:1,250

Cliff **Slopes** **Top**
Rock **Rock (scattered)**
Boulders **Boulders (scattered)**
Positioned Boulder **Scree**
Non-Coniferous Tree (surveyed) **Coniferous Tree (surveyed)**
Non-Coniferous Trees (not surveyed) **Coniferous Trees (not surveyed)**
Orchard Tree **Scrub** **Bracken**
Coppice, Osier **Reeds** **Marsh, Saltings**
Rough Grassland **Heath** **Culvert**
Direction of water flow **Triangulation Station** **Antiquity (site of)**
Electricity Transmission Line **Electricity Pylon**
BM 231.60m Bench Mark **Buildings with Building Seed**
Roofed Building **Glazed Roof Building**
Civil parish/community boundary
District boundary
County boundary
Boundary post/stone
Boundary mereing symbol (note: these always appear in opposed pairs or groups of three)
Bks Barracks **P** Pillar, Pole or Post
Bty Battery **PO** Post Office
Cemy Cemetery **PC** Public Convenience
Chy Chimney **Pp** Pump
Cis Cistern **Ppg Sta** Pumping Station
Dismtd Rly Dismantled Railway **PW** Place of Worship
EI Gen Sta Electricity Generating Station **Sewage Ppg Sta** Sewage Pumping Station
EI P Electricity Pole, Pillar **SB, S Br** Signal Box or Bridge
EI Sub Sta Electricity Sub Station **SP, SL** Signal Post or Light
FB Filter Bed **Spr** Spring
Fn / D Fn Fountain / Drinking Ftn. **Tk** Tank or Track
Gas Gov Gas Valve Compound **Tr** Trough
GVC Gas Governor **Wd Pp** Wind Pump
GP Guide Post **Wr Pt, Wr T** Water Point, Water Tap
MH Manhole **Wks** Works (building or area)
MP, MS Mile Post or Mile Stone **W** Well



Historical Mapping & Photography included:

Mapping Type	Scale	Date	Pg
Lincolnshire	1:2,500	1886	2
Lincolnshire	1:2,500	1906	3
Lincolnshire	1:2,500	1920	4
Ordnance Survey Plan	1:2,500	1975 - 1976	5
Large-Scale National Grid Data	1:2,500	1994	6

Historical Map - Segment F3

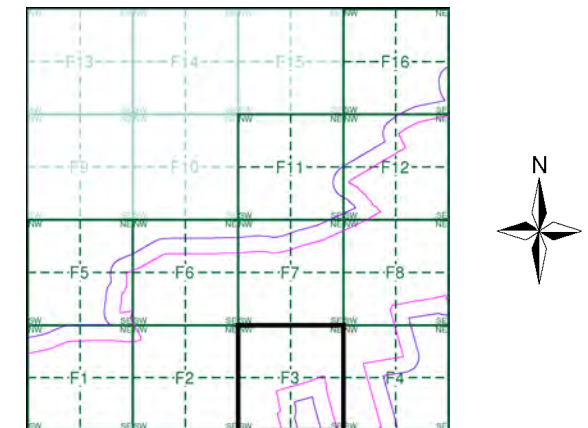

Order Details

Order Number: 297990210_1_1
 Customer Ref: 21-1088.04
 National Grid Reference: 486940, 382710
 Slice: F
 Site Area (Ha): 1120.8
 Search Buffer (m): 100

Site Details

Cottam



Tel: [Redacted]
 Fax: [Redacted]
 Web: [Redacted]

Lincolnshire
Published 1886

Source map scale - 1:2,500

The historical maps shown were reproduced from maps predominantly held at the scale adopted for England, Wales and Scotland in the 1840's. In 1854 the 1:2,500 scale was adopted for mapping urban areas and by 1896 it covered the whole of what were considered to be the cultivated parts of Great Britain. The published date given below is often some years later than the surveyed date. Before 1938, all OS maps were based on the Cassini Projection, with independent surveys of a single county or group of counties, giving rise to significant inaccuracies in outlying areas.

Map Name(s) and Date(s)

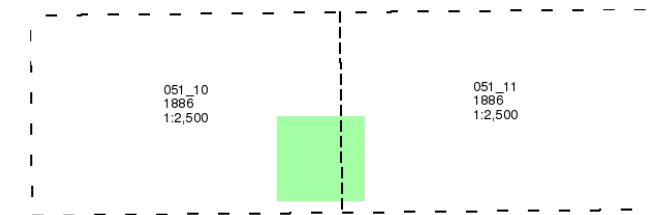

Historical Map - Segment F3

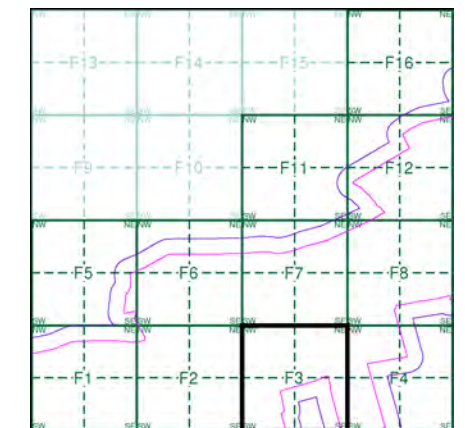

Order Details

Order Number: 297990210_1_1
 Customer Ref: 21-1088.04
 National Grid Reference: 486940, 382710
 Slice: F
 Site Area (Ha): 1120.8
 Search Buffer (m): 100

Site Details

Cottam

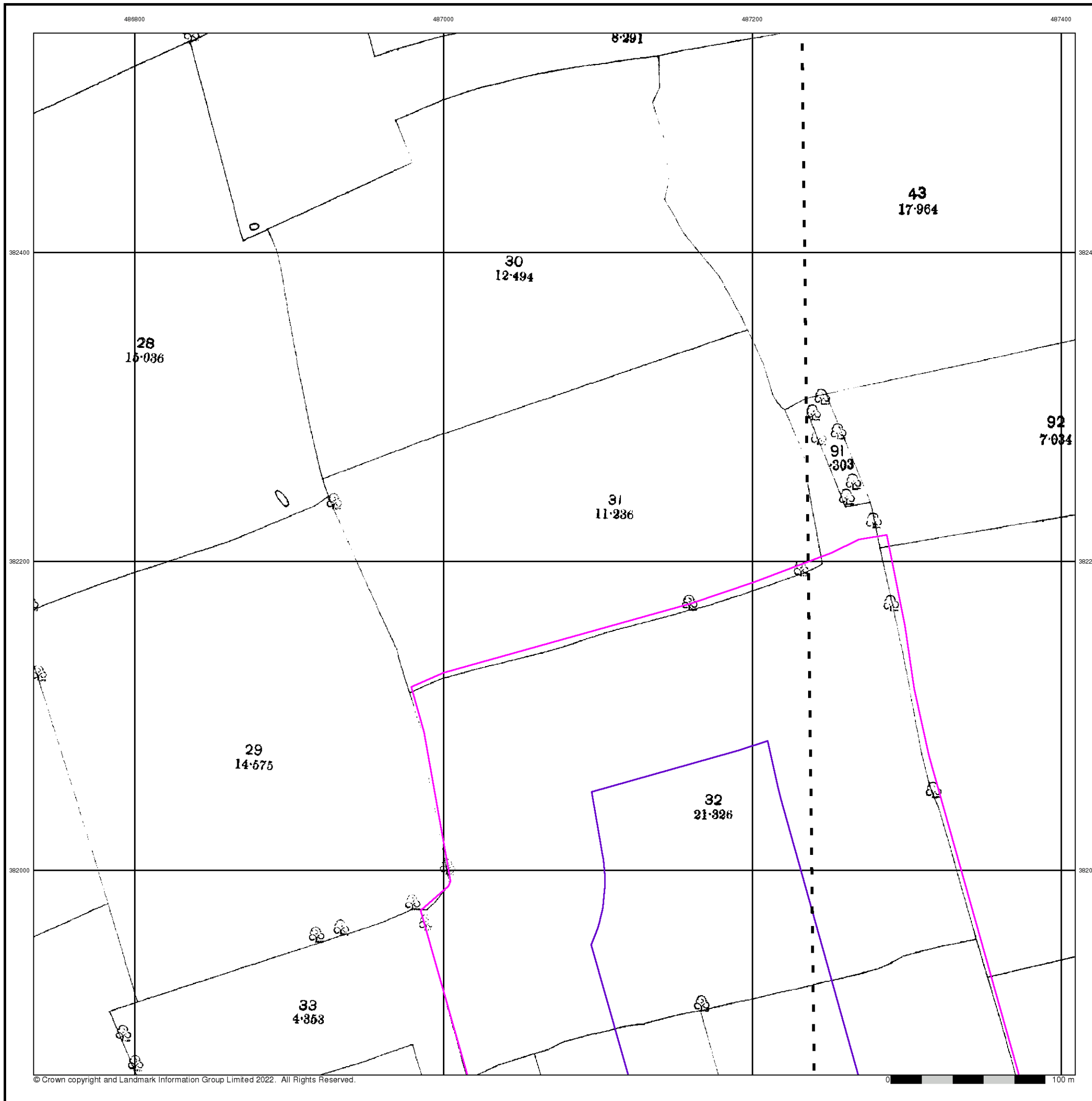

Lincolnshire
Published 1906

Source map scale - 1:2,500

The historical maps shown were reproduced from maps predominantly held at the scale adopted for England, Wales and Scotland in the 1840's. In 1854 the 1:2,500 scale was adopted for mapping urban areas and by 1896 it covered the whole of what were considered to be the cultivated parts of Great Britain. The published date given below is often some years later than the surveyed date. Before 1938, all OS maps were based on the Cassini Projection, with independent surveys of a single county or group of counties, giving rise to significant inaccuracies in outlying areas.

Map Name(s) and Date(s)

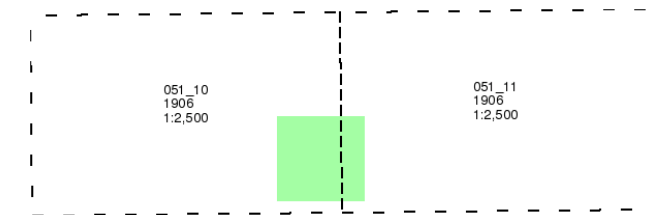

Historical Map - Segment F3

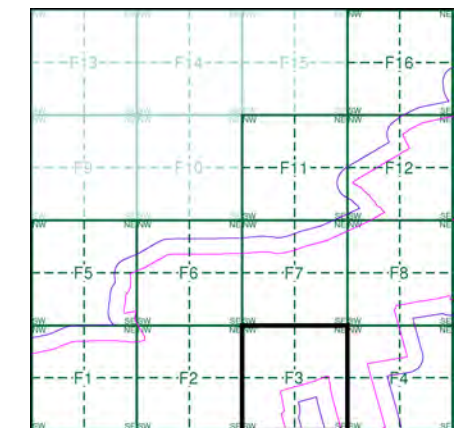

Order Details

Order Number: 297990210_1_1
 Customer Ref: 21-1088.04
 National Grid Reference: 486940, 382710
 Slice: F
 Site Area (Ha): 1120.8
 Search Buffer (m): 100

Site Details

Cottam

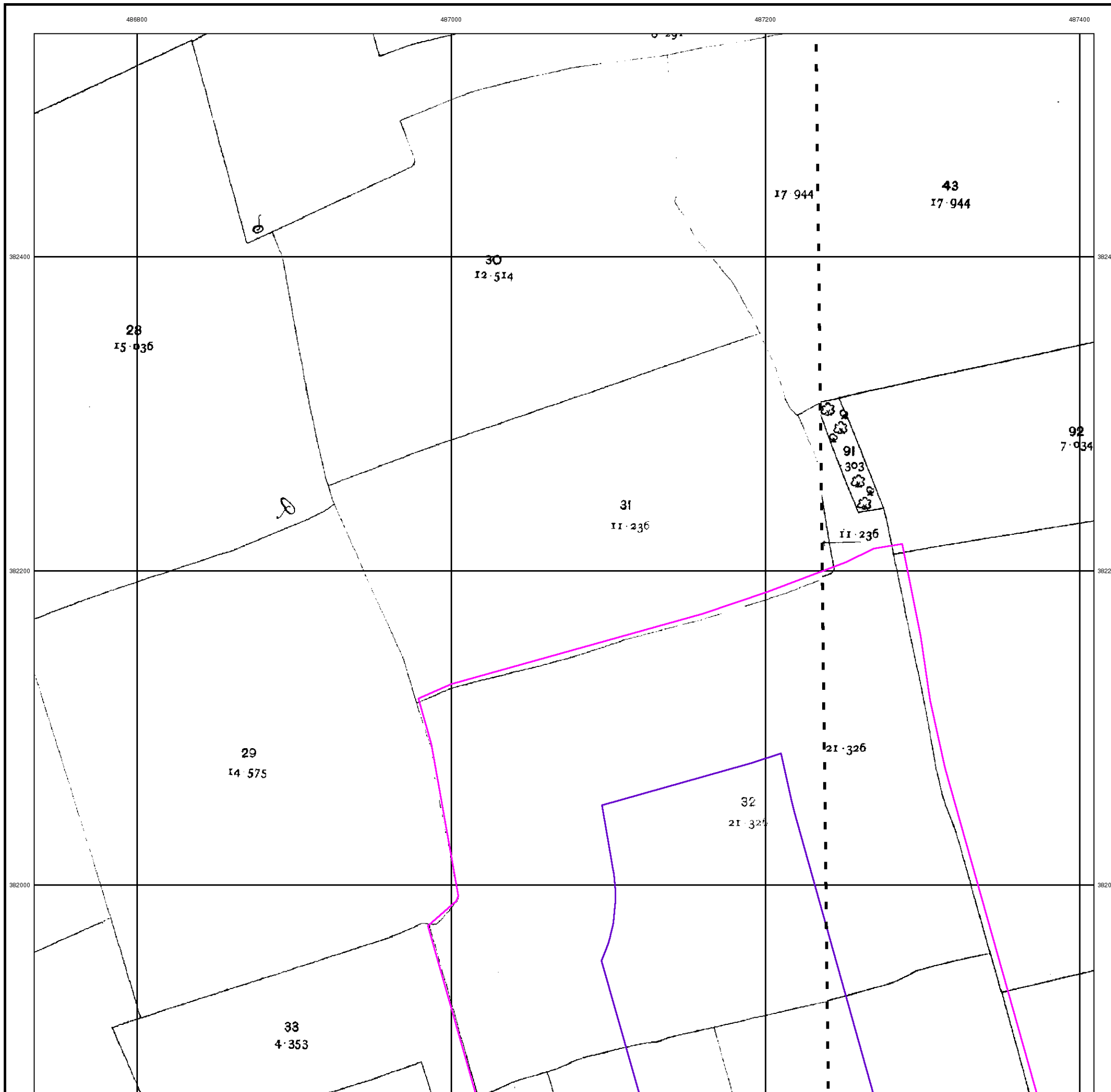

Lincolnshire
Published 1920

Source map scale - 1:2,500

The historical maps shown were reproduced from maps predominantly held at the scale adopted for England, Wales and Scotland in the 1840's. In 1854 the 1:2,500 scale was adopted for mapping urban areas and by 1896 it covered the whole of what were considered to be the cultivated parts of Great Britain. The published date given below is often some years later than the surveyed date. Before 1938, all OS maps were based on the Cassini Projection, with independent surveys of a single county or group of counties, giving rise to significant inaccuracies in outlying areas.

Map Name(s) and Date(s)

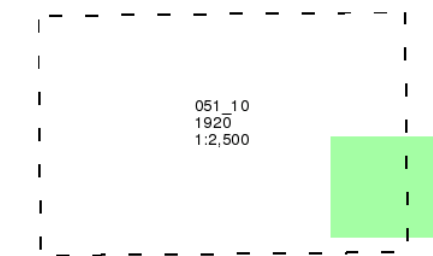

Historical Map - Segment F3

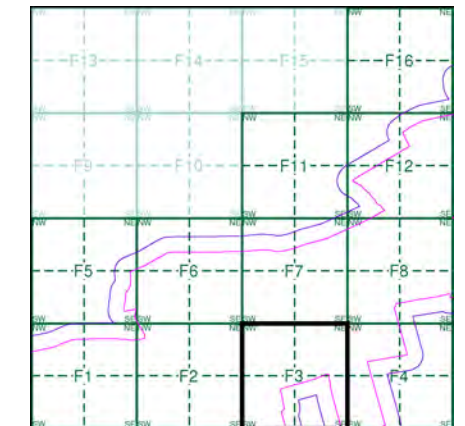

Order Details

Order Number: 297990210_1_1
 Customer Ref: 21-1088.04
 National Grid Reference: 486940, 382710
 Slice: F
 Site Area (Ha): 1120.8
 Search Buffer (m): 100

Site Details

Cottam

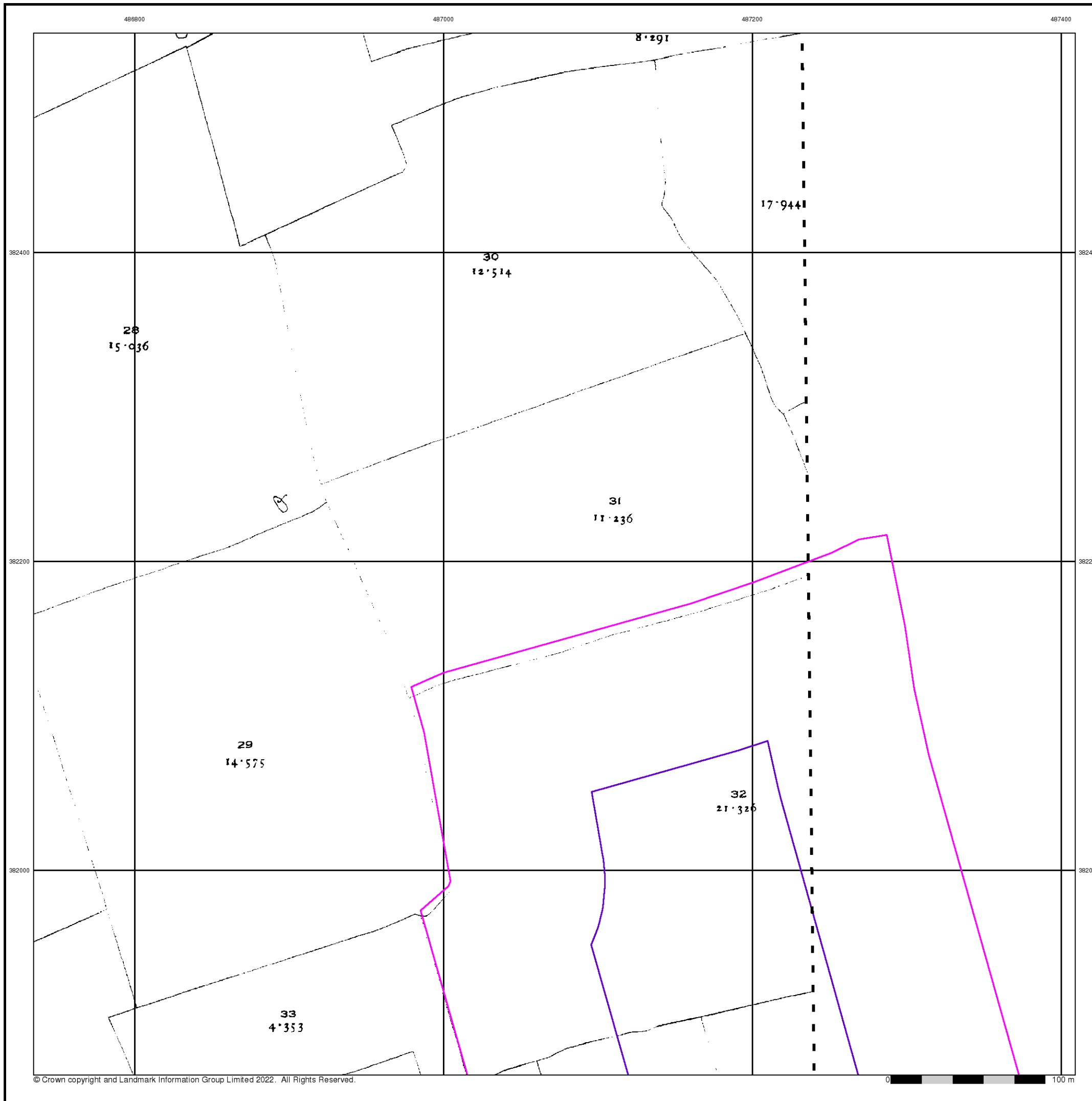

Ordnance Survey Plan
Published 1975 - 1976
Source map scale - 1:2,500

The historical maps shown were reproduced from maps predominantly held at the scale adopted for England, Wales and Scotland in the 1840's. In 1854 the 1:2,500 scale was adopted for mapping urban areas and by 1896 it covered the whole of what were considered to be the cultivated parts of Great Britain. The published date given below is often some years later than the surveyed date. Before 1938, all OS maps were based on the Cassini Projection, with independent surveys of a single county or group of counties, giving rise to significant inaccuracies in outlying areas.

Map Name(s) and Date(s)

SK8682 1975 1:2,500	SK8782 1975 1:2,500
SK8681 1976 1:2,500	SK8781 1976 1:2,500

Historical Map - Segment F3

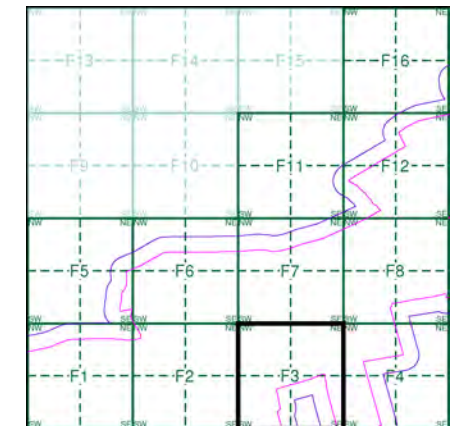

Order Details

Order Number: 297990210_1_1
 Customer Ref: 21-1088.04
 National Grid Reference: 486940, 382710
 Slice: F
 Site Area (Ha): 1120.8
 Search Buffer (m): 100

Site Details

Cottam

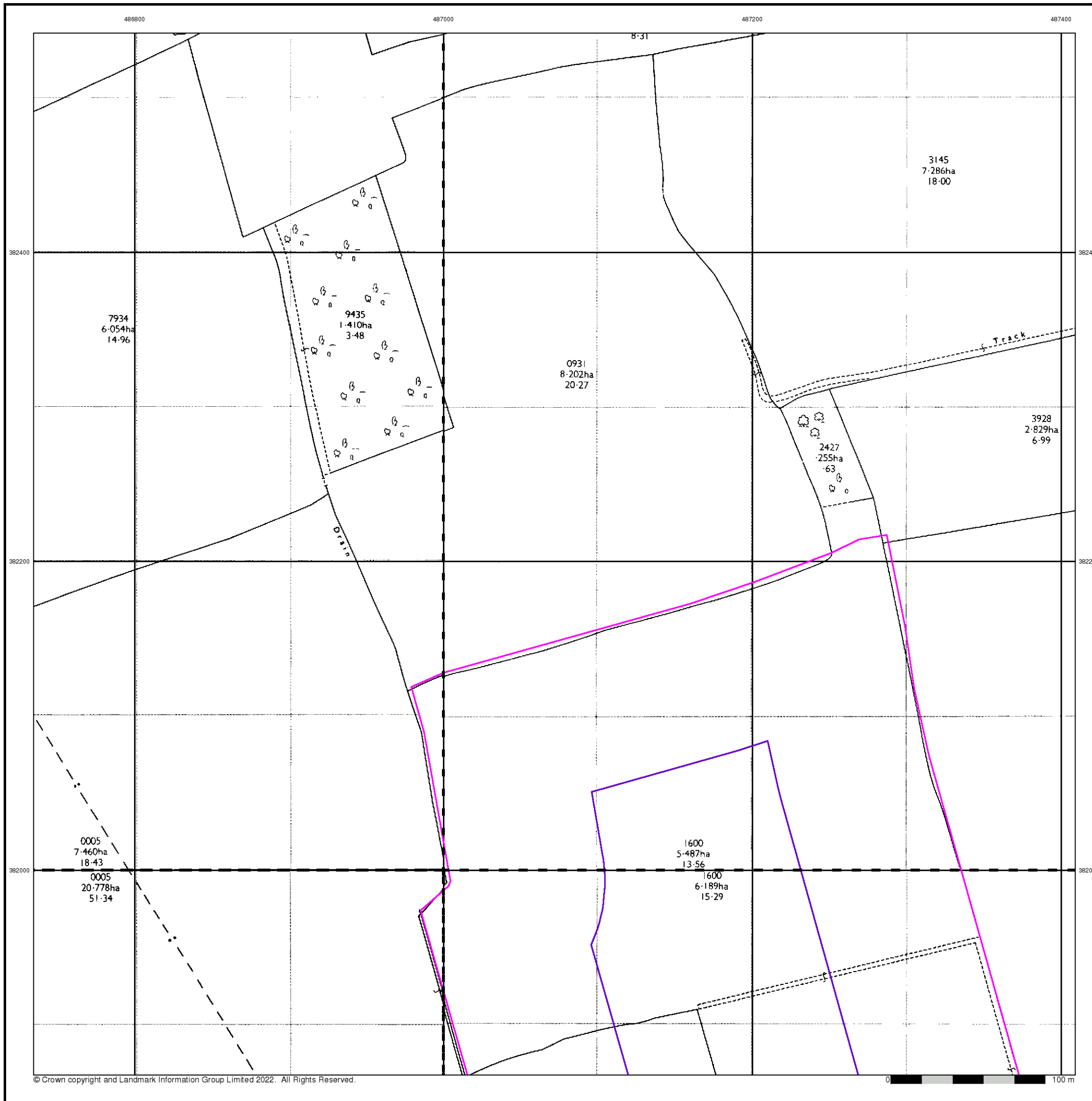

Large-Scale National Grid Data

Published 1994

Source map scale - 1:2,500

'Large Scale National Grid Data' superseded SIM cards (Ordnance Survey's 'Survey of Information on Microfilm') in 1992, and continued to be produced until 1999. These maps were the fore-runners of digital mapping and so provide detailed information on houses and roads, but tend to show less topographic features such as vegetation. These maps were produced at both 1:2,500 and 1:1,250 scales.

Map Name(s) and Date(s)

SK8682 1994 1:2,500	SK8782 1994 1:2,500
SK8681 1994 1:2,500	SK8781 1994 1:2,500

Historical Map - Segment F3

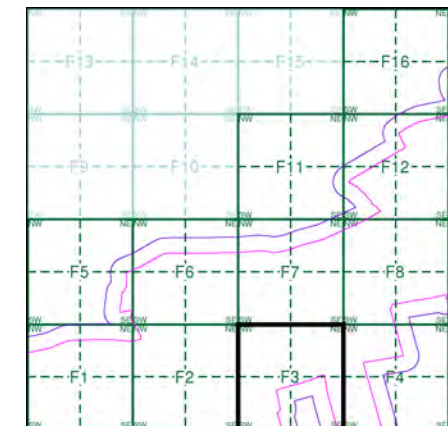

Order Details

Order Number: 297990210_1_1
 Customer Ref: 21-1088.04
 National Grid Reference: 486940, 382710
 Slice: F
 Site Area (Ha): 1120.8
 Search Buffer (m): 100

Site Details

Cottam

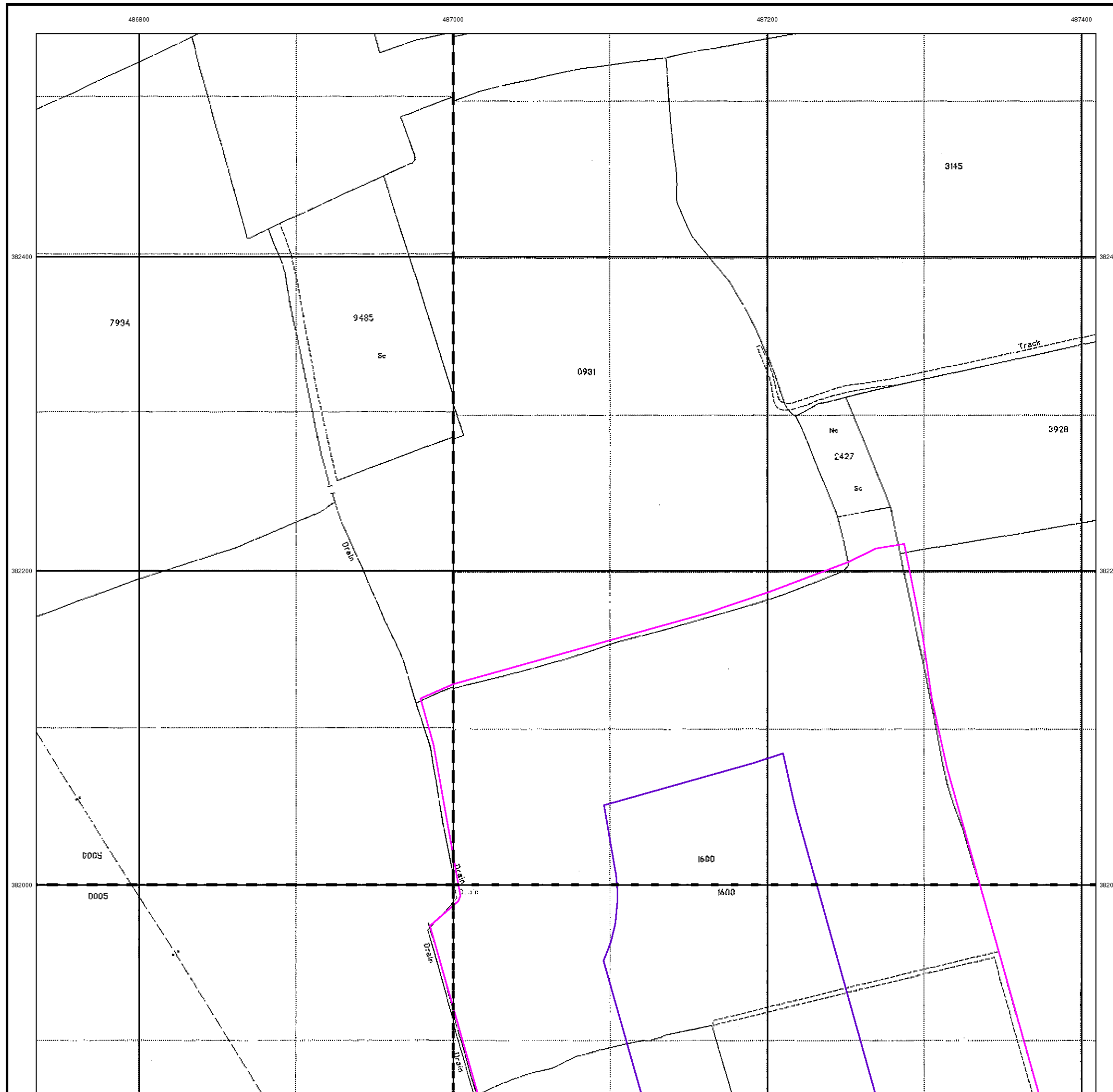

Historical Mapping Legends

Ordnance Survey County Series and Ordnance Survey Plan 1:2,500

Quarry **Gravel Pit** **Sand Pit**
Clay Pit **Shingle** **Refuse Heap**
Sloping Masonry **Flat Rock**
Marsh **Reeds** **Osiers**
Rough Pasture **Furze** **Wood**
Mixed Wood **Brushwood** **Orchard**
Fir **Ford** **Stepping Stones**
Ferry **Waterfall** **Lock**
Trig. Station **Altitude at Trig. Station**
B.M. 325.9 **Bench Mark** **Surface Level**
Arrow denotes flow of water **Antiquities (site of)**
Cutting **Embankment**
Railway crossing Road **Level Crossing** **Road crossing Railway**
Railway crossing River or Canal **Road over single stream** **Road over River or Canal**
County Boundary (Geographical)
County & Civil Parish Boundary
Administrative County & Civil Parish Boundary
County Borough Boundary (England)
Co. Boro. Bdy.
County Burgh Boundary (Scotland)
Boundary Post or Stone **Police Call Box**
B.R. **Bridle Road** **P** **Pump**
E.P. **Electricity Pylon** **S.P.** **Signal Post**
F.B. **Foot Bridge** **Sl.** **Sluice**
F.P. **Foot Path** **Sp.** **Spring**
G.P. **Guide Post or Board** **T.C.B.** **Telephone Call Box**
M.S. **Mile Stone** **Tr.** **Trough**
M.P. M.R. **Mooring Post or Ring** **W** **Well**

Ordnance Survey Plan, Additional SIMs and Supply of Unpublished Survey Information 1:2,500 and 1:1,250

Inactive Quarry, Chalk Pit or Clay Pit **Active Quarry, Chalk Pit or Clay Pit**
Rock **Boulders**
Cliff **Slopes** **Top**
Roofed Building **Glazed Roof Building**
Sloping Masonry **Archway**
Non-Coniferous Tree (surveyed) **Coniferous Tree (surveyed)**
Non-Coniferous Trees (not surveyed) **Coniferous Trees (not surveyed)**
Orchard Tree **Scrub** **Bracken**
Coppice, Osier **Reeds** **Marsh, Saltings**
Rough Grassland **Heath** **Culvert**
Direction of water flow **Bench Mark** **Antiquity (site of)**
Cave Entrance **Triangulation Station** **Electricity Pylon**
Electricity Transmission Line
County Boundary (Geographical)
County & Civil Parish Boundary
Civil Parish Boundary
Admin. County or County Bor. Boundary
London Borough Boundary
Symbol marking point where boundary mereing changes
BH **Beer House** **P** **Pillar, Pole or Post**
BP, BS **Boundary Post or Stone** **PO** **Post Office**
Cn, C **Capstan, Crane** **PC** **Public Convenience**
Chy **Chimney** **PH** **Public House**
D Fn **Drinking Fountain** **Pp** **Pump**
EI P **Electricity Pillar or Post** **SB, S Br** **Signal Box or Bridge**
FAP **Fire Alarm Pillar** **SP, SL** **Signal Post or Light**
FB **Foot Bridge** **Spr** **Spring**
GP **Guide Post** **Tk** **Tank or Track**
H **Hydrant or Hydraulic** **TCB** **Telephone Call Box**
LC **Level Crossing** **TCP** **Telephone Call Post**
MH **Manhole** **Tr** **Trough**
MP **Mile Post or Mooring Post** **Wr Pt, Wr T** **Water Point, Water Tap**
MS **Mile Stone** **W** **Well**
NTL **Normal Tidal Limit** **Wd Pp** **Wind Pump**

Large-Scale National Grid Data 1:2,500 and 1:1,250

Cliff **Slopes** **Top**
Rock **Rock (scattered)**
Boulders **Boulders (scattered)**
Positioned Boulder **Scree**
Non-Coniferous Tree (surveyed) **Coniferous Tree (surveyed)**
Non-Coniferous Trees (not surveyed) **Coniferous Trees (not surveyed)**
Orchard Tree **Scrub** **Bracken**
Coppice, Osier **Reeds** **Marsh, Saltings**
Rough Grassland **Heath** **Culvert**
Direction of water flow **Triangulation Station** **Antiquity (site of)**
Electricity Transmission Line **Electricity Pylon**
B.M. 231.60m **Bench Mark** **Buildings with Building Seed**
Roofed Building **Glazed Roof Building**
Civil parish/community boundary
District boundary
County boundary
Boundary post/stone
Boundary mereing symbol (note: these always appear in opposed pairs or groups of three)
Bks **Barracks** **P** **Pillar, Pole or Post**
Bty **Battery** **PO** **Post Office**
Cemy **Cemetery** **PC** **Public Convenience**
Chy **Chimney** **Pp** **Pump**
Cis **Cistern** **Ppg Sta** **Pumping Station**
Dismtd Rly **Dismantled Railway** **PW** **Place of Worship**
EI Gen Sta **Electricity Generating Station** **Sewage Ppg Sta** **Sewage Pumping Station**
EI P **Electricity Pole, Pillar** **SB, S Br** **Signal Box or Bridge**
EI Sub Sta **Electricity Sub Station** **SP, SL** **Signal Post or Light**
FB **Filter Bed** **Spr** **Spring**
Fn / D Fn **Fountain / Drinking Ftn.** **Tk** **Tank or Track**
Gas Gov **Gas Valve Compound** **Tr** **Trough**
GVC **Gas Governor** **Wd Pp** **Wind Pump**
GP **Guide Post** **Wr Pt, Wr T** **Water Point, Water Tap**
MH **Manhole** **Wks** **Works (building or area)**
MP, MS **Mile Post or Mile Stone** **W** **Well**



Historical Mapping & Photography included:

Mapping Type	Scale	Date	Pg
Lincolnshire	1:2,500	1886	2
Lincolnshire	1:2,500	1906	3
Ordnance Survey Plan	1:2,500	1975 - 1976	4
Large-Scale National Grid Data	1:2,500	1994	5

Historical Map - Segment F4

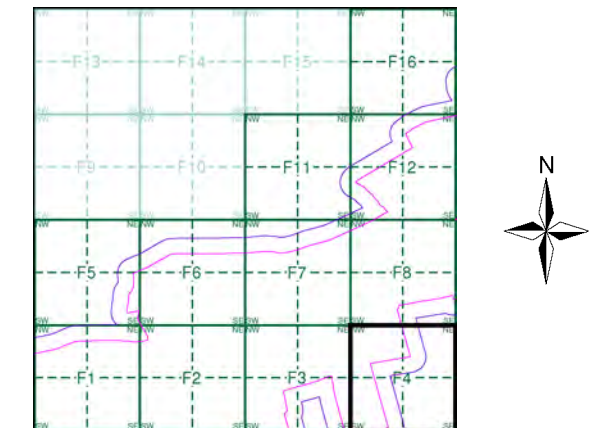

Order Details

Order Number: 297990210_1_1
Customer Ref: 21-1088.04
National Grid Reference: 486940, 382710
Slice: F
Site Area (Ha): 1120.8
Search Buffer (m): 100

Site Details

Cottam



Tel: [Redacted]
Fax: [Redacted]
Web: [Redacted]

Lincolnshire

Published 1886

Source map scale - 1:2,500

The historical maps shown were reproduced from maps predominantly held at the scale adopted for England, Wales and Scotland in the 1840's. In 1854 the 1:2,500 scale was adopted for mapping urban areas and by 1896 it covered the whole of what were considered to be the cultivated parts of Great Britain. The published date given below is often some years later than the surveyed date. Before 1938, all OS maps were based on the Cassini Projection, with independent surveys of a single county or group of counties, giving rise to significant inaccuracies in outlying areas.

Map Name(s) and Date(s)

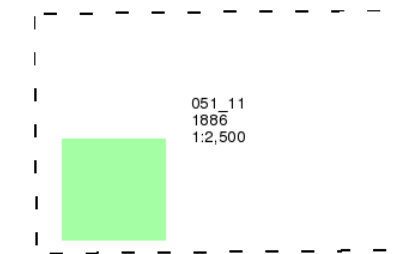

Historical Map - Segment F4

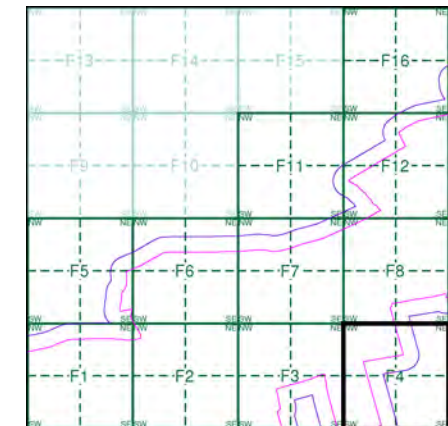

Order Details

Order Number: 297990210_1_1
 Customer Ref: 21-1088.04
 National Grid Reference: 486940, 382710
 Slice: F
 Site Area (Ha): 1120.8
 Search Buffer (m): 100

Site Details

Cottam

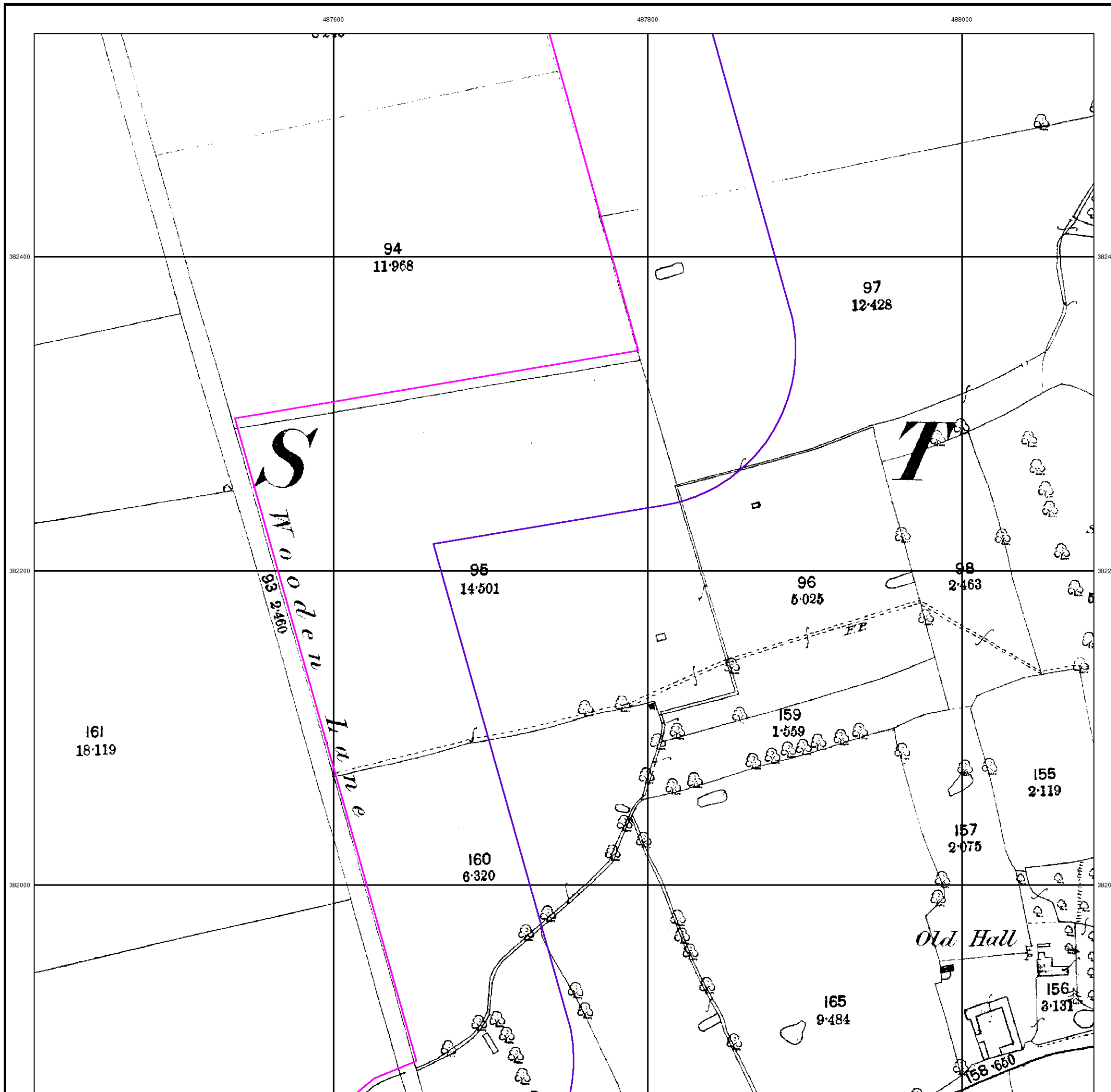



Lincolnshire
Published 1906
Source map scale - 1:2,500

The historical maps shown were reproduced from maps predominantly held at the scale adopted for England, Wales and Scotland in the 1840's. In 1854 the 1:2,500 scale was adopted for mapping urban areas and by 1896 it covered the whole of what were considered to be the cultivated parts of Great Britain. The published date given below is often some years later than the surveyed date. Before 1938, all OS maps were based on the Cassini Projection, with independent surveys of a single county or group of counties, giving rise to significant inaccuracies in outlying areas.

Map Name(s) and Date(s)

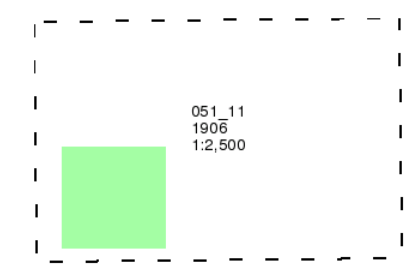

Historical Map - Segment F4

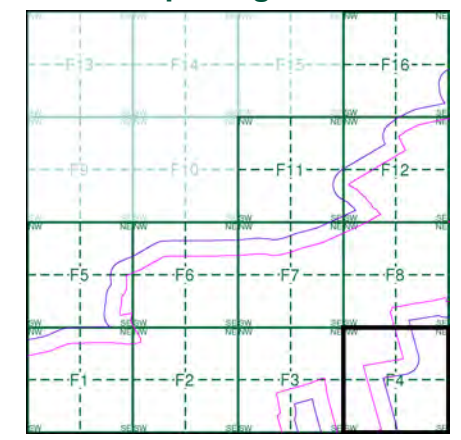

Order Details

Order Number: 297990210_1_1
Customer Ref: 21-1088.04
National Grid Reference: 486940, 382710
Slice: F
Site Area (Ha): 1120.8
Search Buffer (m): 100

Site Details

Cottam



Tel: [Redacted]
Fax: [Redacted]
Web: [Redacted]

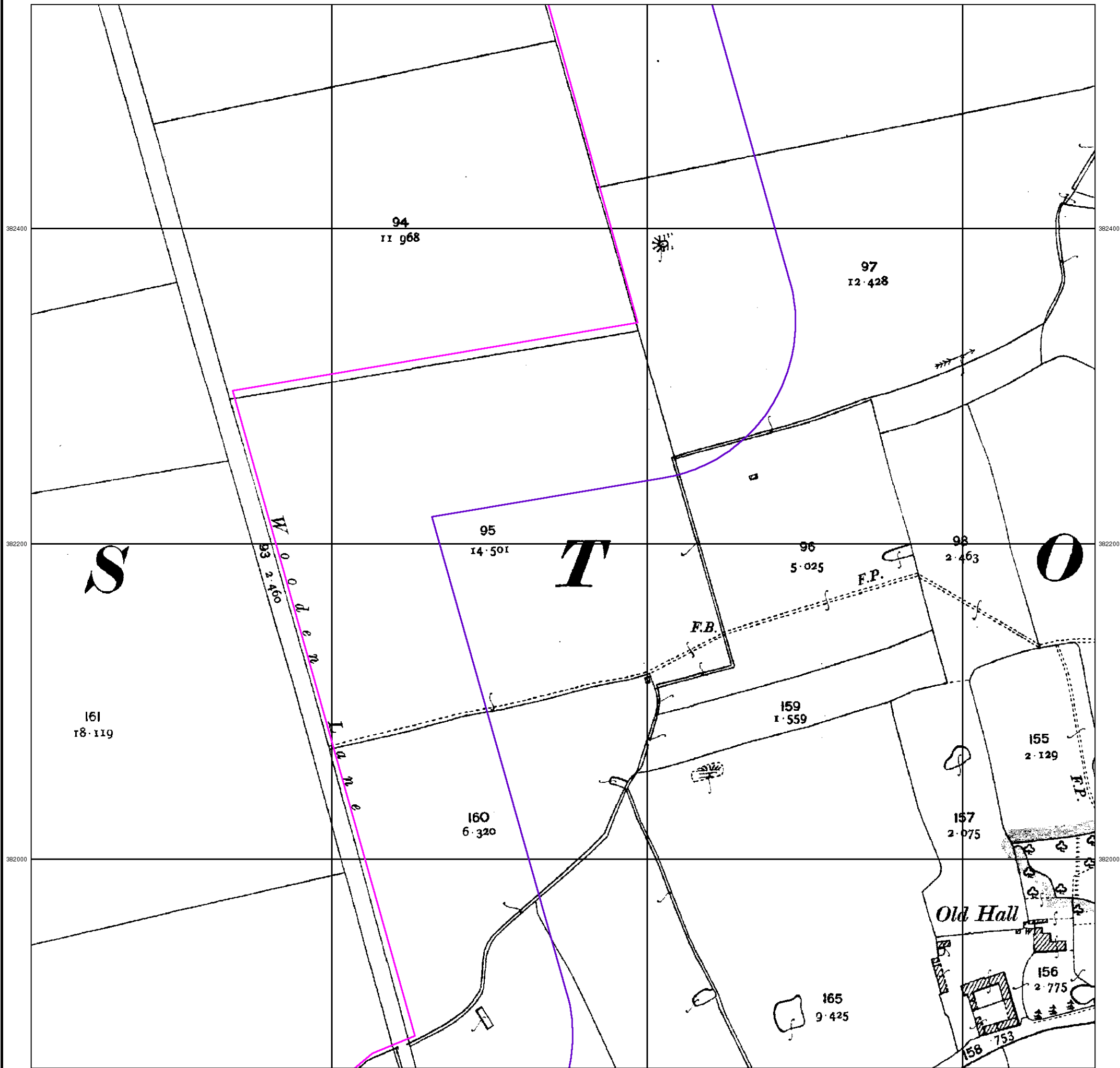

Ordnance Survey Plan
Published 1975 - 1976
Source map scale - 1:2,500

The historical maps shown were reproduced from maps predominantly held at the scale adopted for England, Wales and Scotland in the 1840's. In 1854 the 1:2,500 scale was adopted for mapping urban areas and by 1896 it covered the whole of what were considered to be the cultivated parts of Great Britain. The published date given below is often some years later than the surveyed date. Before 1938, all OS maps were based on the Cassini Projection, with independent surveys of a single county or group of counties, giving rise to significant inaccuracies in outlying areas.

Map Name(s) and Date(s)

SK8782 1975 12,500	SK8882 1975 12,500
SK8781 1976 12,500	SK8881 1975 12,500

Historical Map - Segment F4

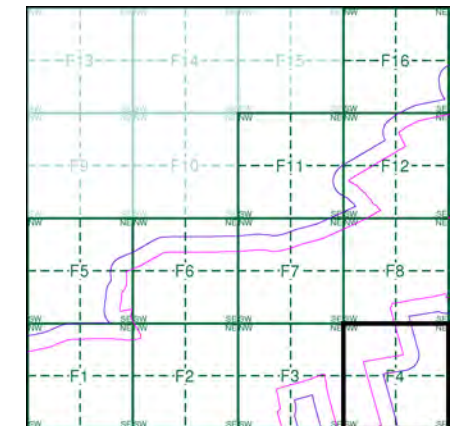

Order Details

Order Number: 297990210_1_1
 Customer Ref: 21-1088.04
 National Grid Reference: 486940, 382710
 Slice: F
 Site Area (Ha): 1120.8
 Search Buffer (m): 100

Site Details

Cottam

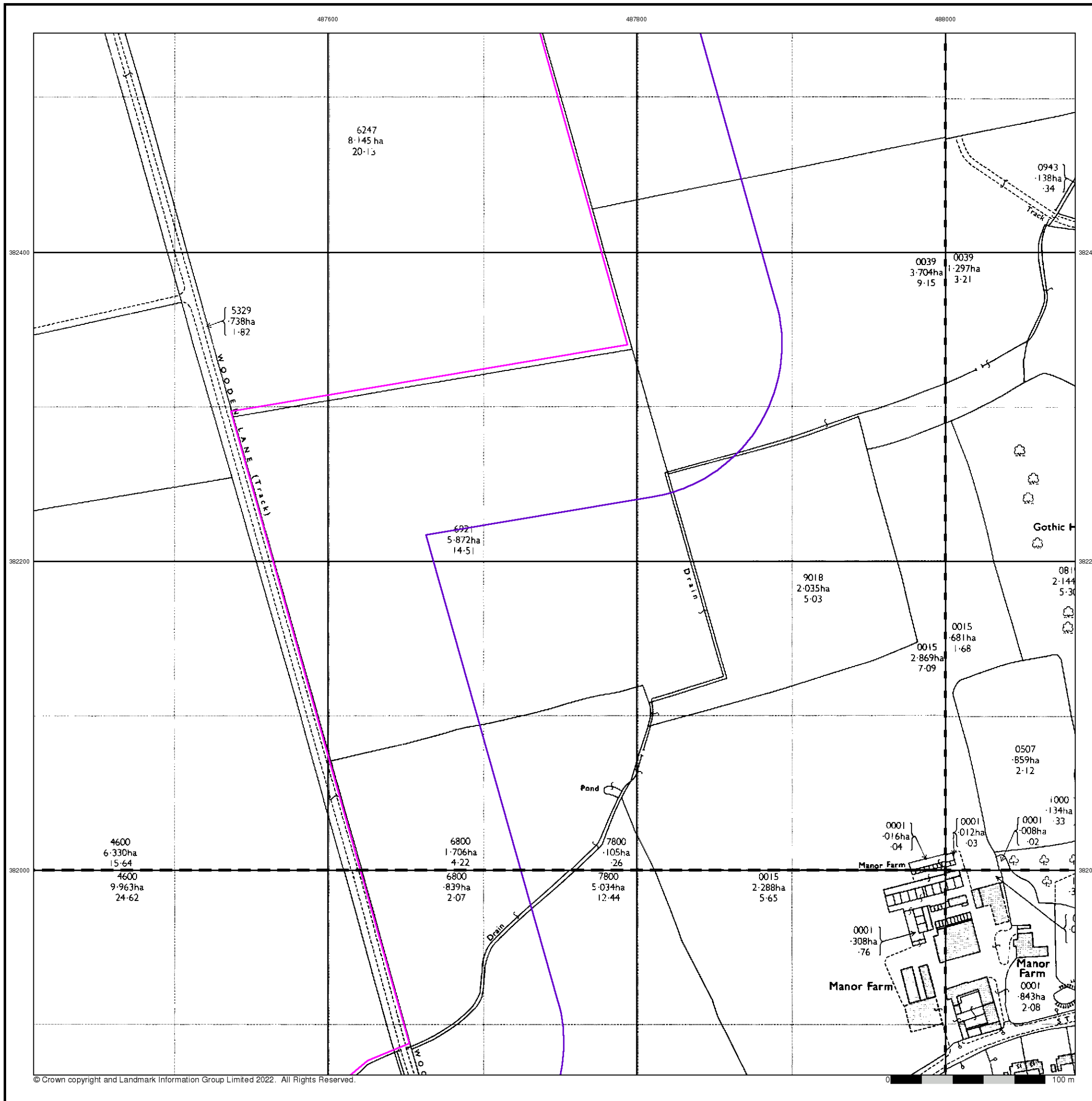

Large-Scale National Grid Data

Published 1994

Source map scale - 1:2,500

'Large Scale National Grid Data' superseded SIM cards (Ordnance Survey's 'Survey of Information on Microfilm') in 1992, and continued to be produced until 1999. These maps were the fore-runners of digital mapping and so provide detailed information on houses and roads, but tend to show less topographic features such as vegetation. These maps were produced at both 1:2,500 and 1:1,250 scales.

Map Name(s) and Date(s)

SK8782 1994 1:2,500	SK8882 1994 1:2,500
SK8781 1994 1:2,500	SK8881 1994 1:2,500

Historical Map - Segment F4

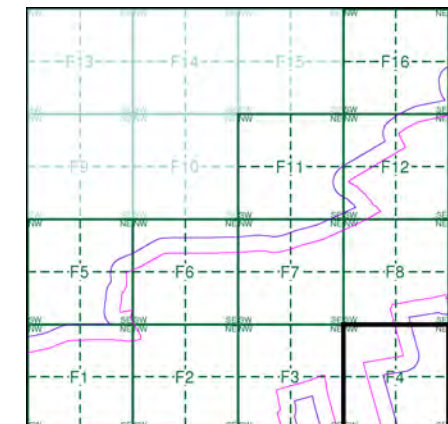

Order Details

Order Number: 297990210_1_1
 Customer Ref: 21-1088.04
 National Grid Reference: 486940, 382710
 Slice: F
 Site Area (Ha): 1120.8
 Search Buffer (m): 100

Site Details

Cottam

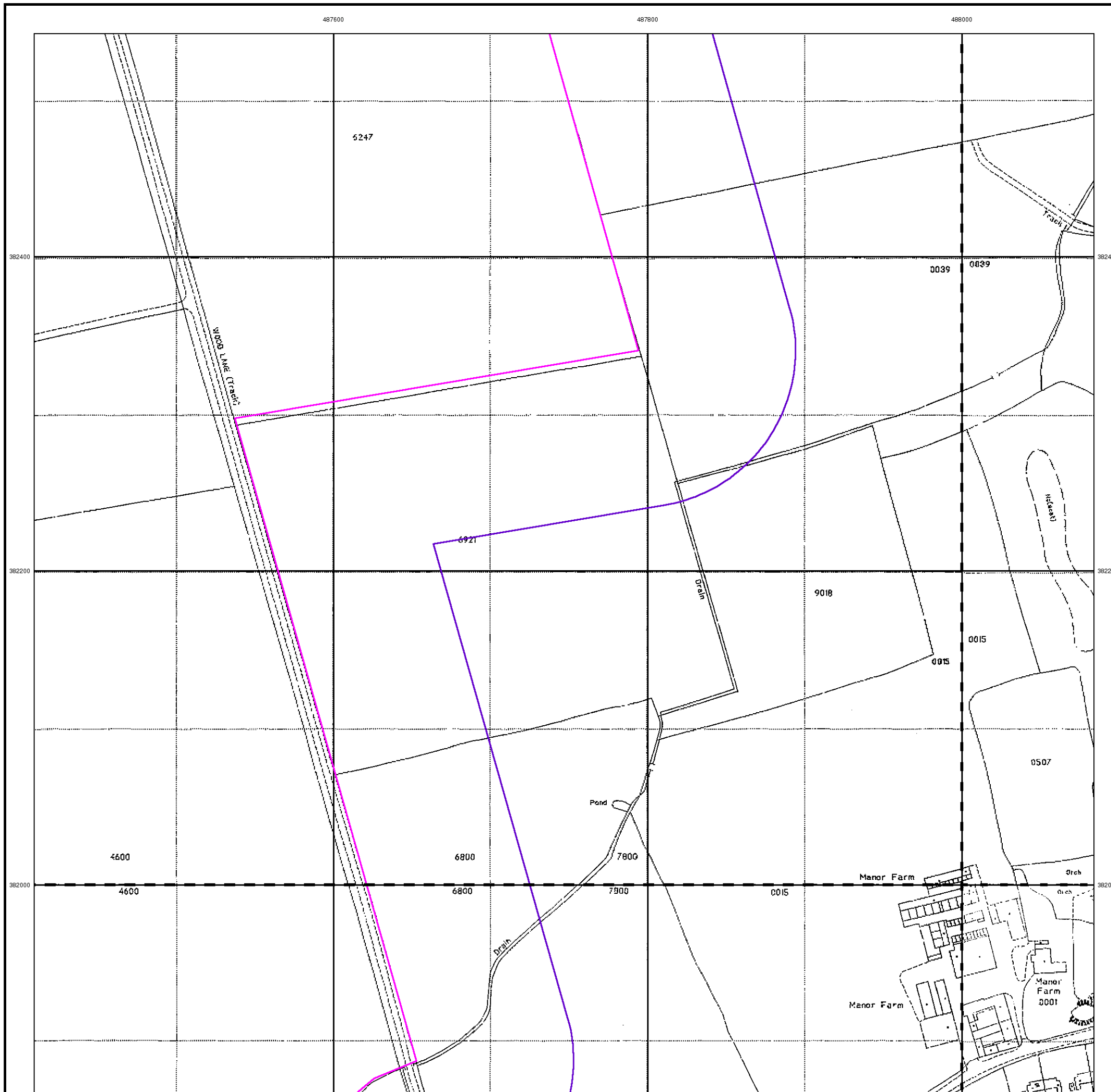

Historical Mapping Legends

Ordnance Survey County Series and Ordnance Survey Plan 1:2,500

Quarry **Gravel Pit** **Sand Pit**
Clay Pit **Shingle** **Refuse Heap**
Sloping Masonry **Flat Rock**
Marsh **Reeds** **Osiers**
Rough Pasture **Furze** **Wood**
Mixed Wood **Brushwood** **Orchard**
Fir **Ford** **Stepping Stones**
Ferry **Waterfall** **Lock**
Trig. Station **Altitude at Trig. Station**
B.M. 325.9 **Bench Mark** **Surface Level**
Arrow denotes flow of water **Antiquities (site of)**
Cutting **Embankment**
Railway crossing Road **Level Crossing** **Road crossing Railway**
Railway crossing River or Canal **Road over single stream** **Road over River or Canal**
County Boundary (Geographical)
County & Civil Parish Boundary
Administrative County & Civil Parish Boundary
County Borough Boundary (England)
Co. Boro. Bdy.
County Burgh Boundary (Scotland)
Co. Burgh Bdy.
BP BS Boundary Post or Stone **P.C.B** Police Call Box
B.R. Bridle Road **P** Pump
E.P Electricity Pylon **S.P** Signal Post
F.B. Foot Bridge **SL** Sluice
F.P. Foot Path **Sp.** Spring
G.P Guide Post or Board **T.C.B** Telephone Call Box
M.S Mile Stone **Tr.** Trough
M.P M.R Mooring Post or Ring **W** Well

Ordnance Survey Plan, Additional SIMs and Supply of Unpublished Survey Information 1:2,500 and 1:1,250

Inactive Quarry, Chalk Pit or Clay Pit **Active Quarry, Chalk Pit or Clay Pit**
Rock **Boulders**
Cliff **Slopes** **Top**
Roofed Building **Glazed Roof Building**
Sloping Masonry **Archway**
Non-Coniferous Tree (surveyed) **Coniferous Tree (surveyed)**
Non-Coniferous Trees (not surveyed) **Coniferous Trees (not surveyed)**
Orchard Tree **Scrub** **Bracken**
Coppice, Osier **Reeds** **Marsh, Saltings**
Rough Grassland **Heath** **Culvert**
Direction of water flow **Bench Mark** **Antiquity (site of)**
Cave Entrance **Triangulation Station** **Electricity Pylon**
Electricity Transmission Line
County Boundary (Geographical)
County & Civil Parish Boundary
Civil Parish Boundary
Admin. County or County Bor. Boundary
London Borough Boundary
Symbol marking point where boundary mereing changes
BH Beer House **P** Pillar, Pole or Post
BP, BS Boundary Post or Stone **PO** Post Office
Cn, C Capstan, Crane **PC** Public Convenience
Chy Chimney **PH** Public House
D Fn Drinking Fountain **Pp** Pump
EI P Electricity Pillar or Post **SB, S Br** Signal Box or Bridge
FAP Fire Alarm Pillar **SP, SL** Signal Post or Light
FB Foot Bridge **Spr** Spring
GP Guide Post **Tk** Tank or Track
H Hydrant or Hydraulic **TCB** Telephone Call Box
LC Level Crossing **TCP** Telephone Call Post
MH Manhole **Tr** Trough
MP Mile Post or Mooring Post **Wr Pt, Wr T** Water Point, Water Tap
MS Mile Stone **W** Well
NTL Normal Tidal Limit **Wd Pp** Wind Pump

Large-Scale National Grid Data 1:2,500 and 1:1,250

Cliff **Slopes** **Top**
Rock **Rock (scattered)**
Boulders **Boulders (scattered)**
Positioned Boulder **Scree**
Non-Coniferous Tree (surveyed) **Coniferous Tree (surveyed)**
Non-Coniferous Trees (not surveyed) **Coniferous Trees (not surveyed)**
Orchard Tree **Scrub** **Bracken**
Coppice, Osier **Reeds** **Marsh, Saltings**
Rough Grassland **Heath** **Culvert**
Direction of water flow **Triangulation Station** **Antiquity (site of)**
Electricity Transmission Line **Electricity Pylon**
BM 231.60m Bench Mark **Buildings with Building Seed**
Roofed Building **Glazed Roof Building**
Civil parish/community boundary
District boundary
County boundary
Boundary post/stone
Boundary mereing symbol (note: these always appear in opposed pairs or groups of three)
Bks Barracks **P** Pillar, Pole or Post
Bty Battery **PO** Post Office
Cemy Cemetery **PC** Public Convenience
Chy Chimney **Pp** Pump
Cis Cistern **Ppg Sta** Pumping Station
Dismtd Rly Dismantled Railway **PW** Place of Worship
EI Gen Sta Electricity Generating Station **Sewage Ppg Sta** Sewage Pumping Station
EI P Electricity Pole, Pillar **SB, S Br** Signal Box or Bridge
EI Sub Sta Electricity Sub Station **SP, SL** Signal Post or Light
FB Filter Bed **Spr** Spring
Fn / D Fn Fountain / Drinking Ftn. **Tk** Tank or Track
Gas Gov Gas Valve Compound **Tr** Trough
GVC Gas Governor **Wd Pp** Wind Pump
GP Guide Post **Wr Pt, Wr T** Water Point, Water Tap
MH Manhole **Wks** Works (building or area)
MP, MS Mile Post or Mile Stone **W** Well



Historical Mapping & Photography included:

Mapping Type	Scale	Date	Pg
Lincolnshire	1:2,500	1886	2
Lincolnshire	1:2,500	1906	3
Lincolnshire	1:2,500	1920	4
Ordnance Survey Plan	1:2,500	1974 - 1975	5
Large-Scale National Grid Data	1:2,500	1994	6

Historical Map - Segment F5

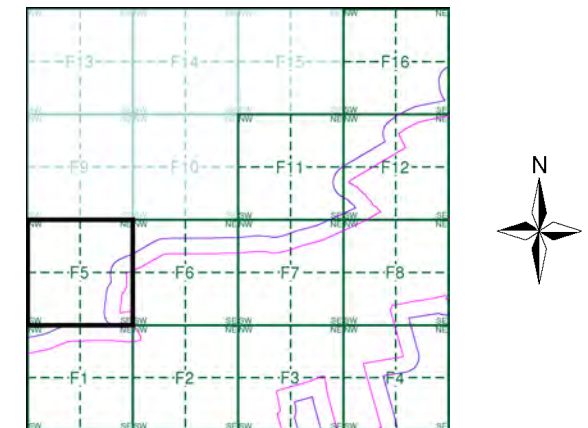

Order Details

Order Number: 297990210_1_1
 Customer Ref: 21-1088.04
 National Grid Reference: 486940, 382710
 Slice: F
 Site Area (Ha): 1120.8
 Search Buffer (m): 100

Site Details

Cottam



Tel: [Redacted]
 Fax: [Redacted]
 Web: [Redacted]

Lincolnshire
Published 1886

Source map scale - 1:2,500

The historical maps shown were reproduced from maps predominantly held at the scale adopted for England, Wales and Scotland in the 1840's. In 1854 the 1:2,500 scale was adopted for mapping urban areas and by 1896 it covered the whole of what were considered to be the cultivated parts of Great Britain. The published date given below is often some years later than the surveyed date. Before 1938, all OS maps were based on the Cassini Projection, with independent surveys of a single county or group of counties, giving rise to significant inaccuracies in outlying areas.

Map Name(s) and Date(s)

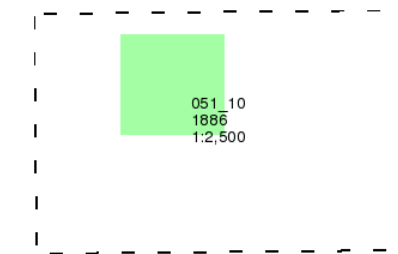

Historical Map - Segment F5

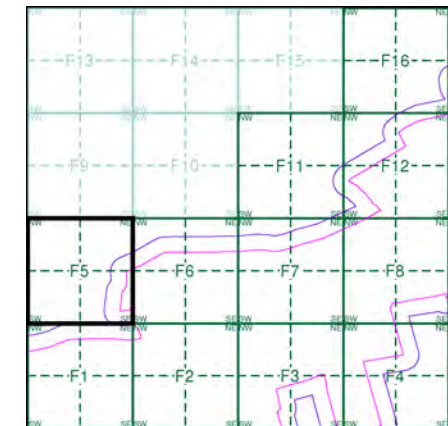

Order Details

Order Number: 297990210_1_1
 Customer Ref: 21-1088.04
 National Grid Reference: 486940, 382710
 Slice: F
 Site Area (Ha): 1120.8
 Search Buffer (m): 100

Site Details

Cottam

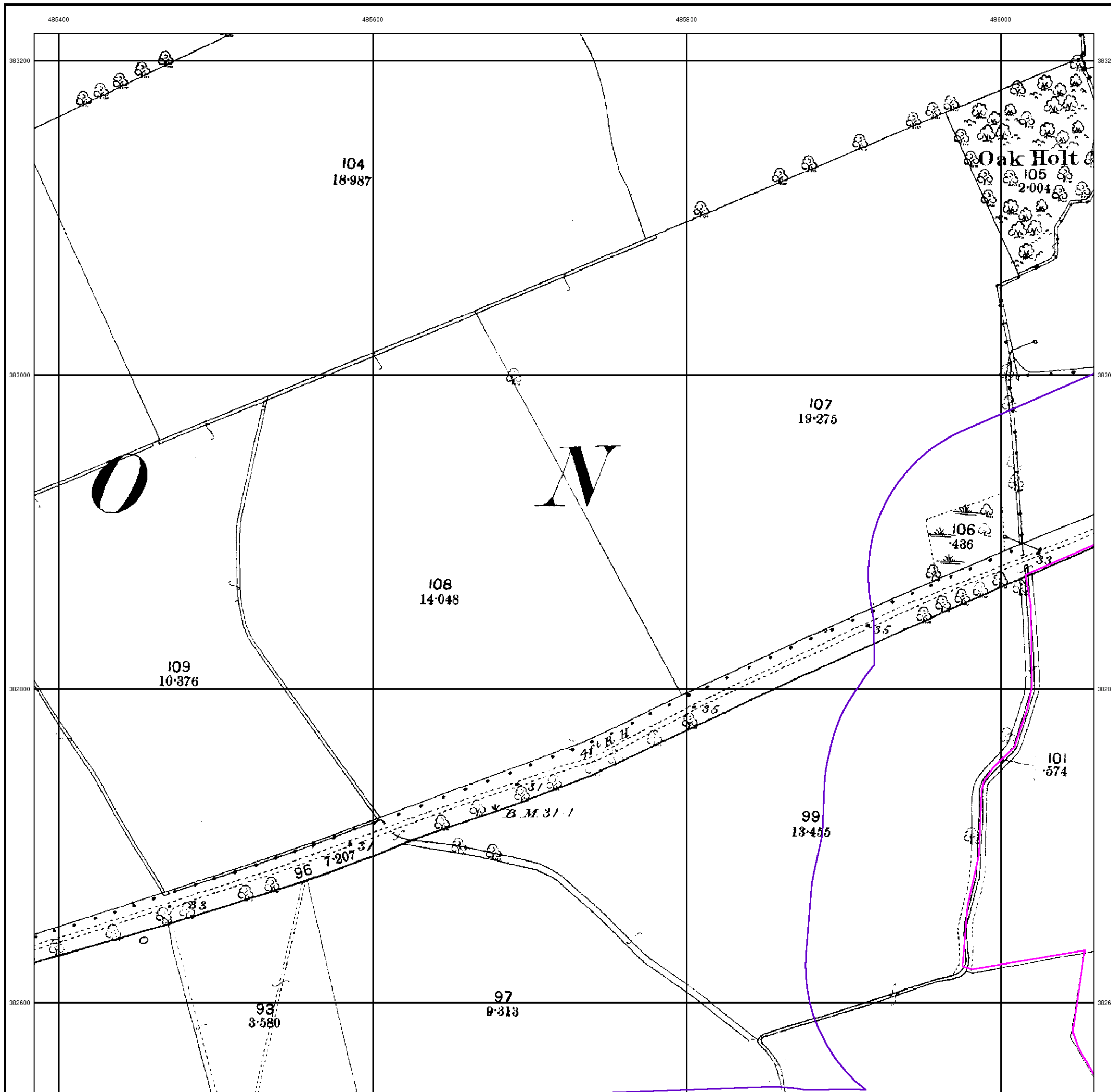

Lincolnshire

Published 1906

Source map scale - 1:2,500

The historical maps shown were reproduced from maps predominantly held at the scale adopted for England, Wales and Scotland in the 1840's. In 1854 the 1:2,500 scale was adopted for mapping urban areas and by 1896 it covered the whole of what were considered to be the cultivated parts of Great Britain. The published date given below is often some years later than the surveyed date. Before 1938, all OS maps were based on the Cassini Projection, with independent surveys of a single county or group of counties, giving rise to significant inaccuracies in outlying areas.

Map Name(s) and Date(s)

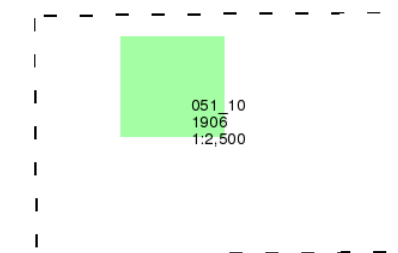

Historical Map - Segment F5

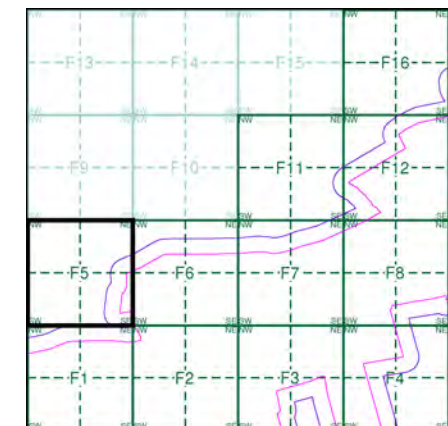

Order Details

Order Number: 297990210_1_1
 Customer Ref: 21-1088.04
 National Grid Reference: 486940, 382710
 Slice: F
 Site Area (Ha): 1120.8
 Search Buffer (m): 100

Site Details

Cottam

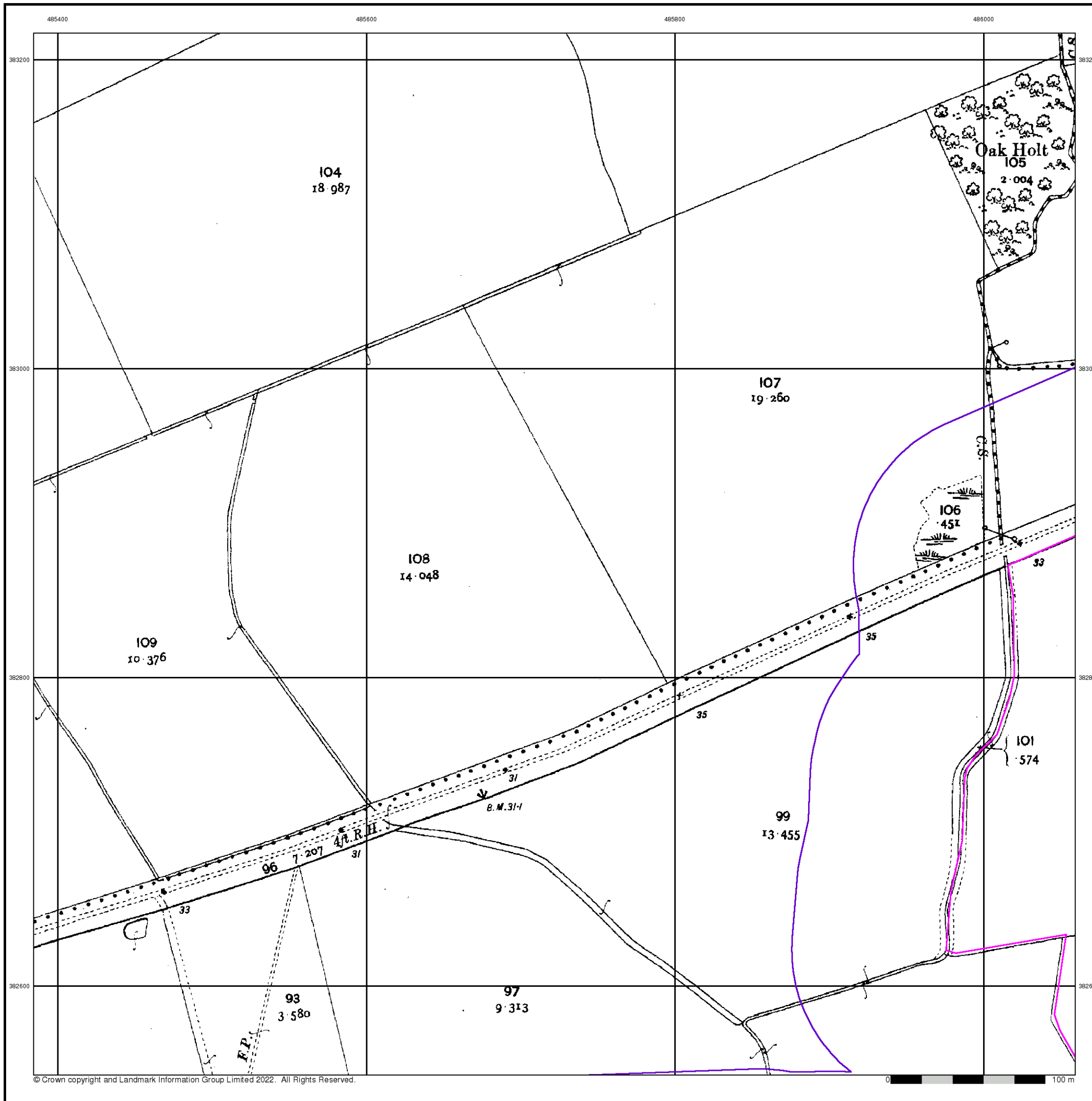

Lincolnshire

Published 1920

Source map scale - 1:2,500

The historical maps shown were reproduced from maps predominantly held at the scale adopted for England, Wales and Scotland in the 1840's. In 1854 the 1:2,500 scale was adopted for mapping urban areas and by 1896 it covered the whole of what were considered to be the cultivated parts of Great Britain. The published date given below is often some years later than the surveyed date. Before 1938, all OS maps were based on the Cassini Projection, with independent surveys of a single county or group of counties, giving rise to significant inaccuracies in outlying areas.

Map Name(s) and Date(s)

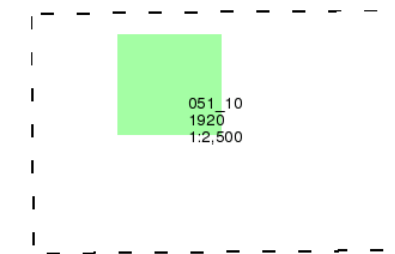

Historical Map - Segment F5

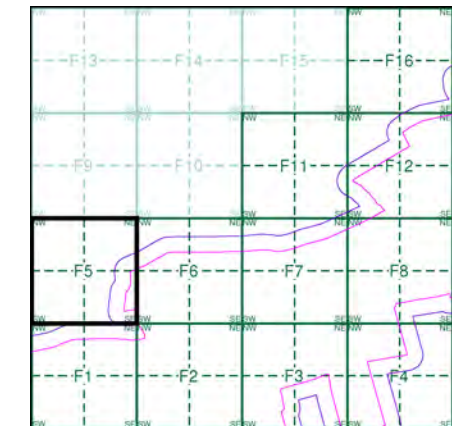

Order Details

Order Number: 297990210_1_1
 Customer Ref: 21-1088.04
 National Grid Reference: 486940, 382710
 Slice: F
 Site Area (Ha): 1120.8
 Search Buffer (m): 100

Site Details

Cottam

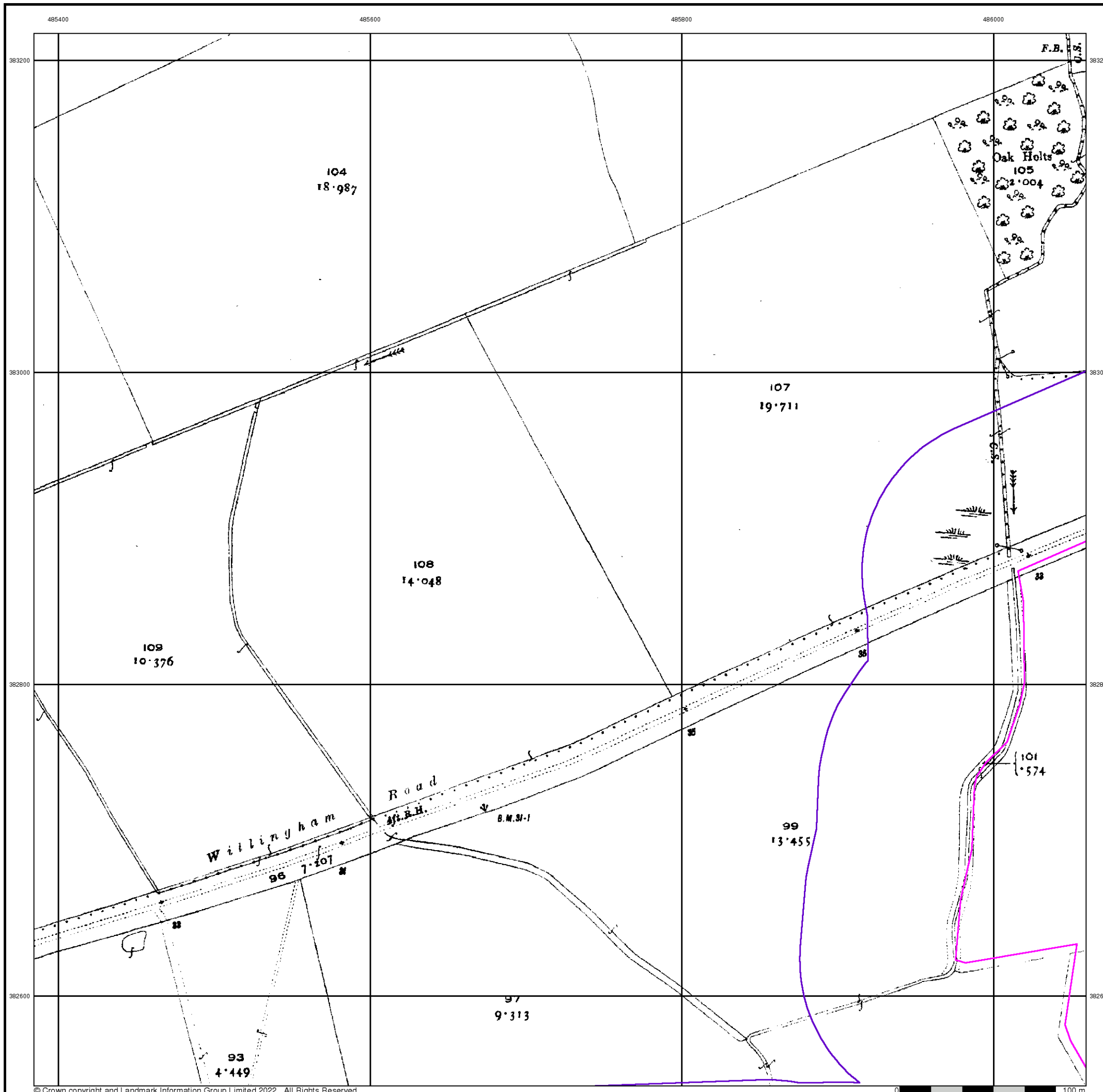

Ordnance Survey Plan
Published 1974 - 1975
Source map scale - 1:2,500

The historical maps shown were reproduced from maps predominantly held at the scale adopted for England, Wales and Scotland in the 1840's. In 1854 the 1:2,500 scale was adopted for mapping urban areas and by 1896 it covered the whole of what were considered to be the cultivated parts of Great Britain. The published date given below is often some years later than the surveyed date. Before 1938, all OS maps were based on the Cassini Projection, with independent surveys of a single county or group of counties, giving rise to significant inaccuracies in outlying areas.

Map Name(s) and Date(s)

SK8583 1974 1:2,500	SK8883 1975 1:2,500
SK8582 1975 1:2,500	SK8882 1975 1:2,500

Historical Map - Segment F5

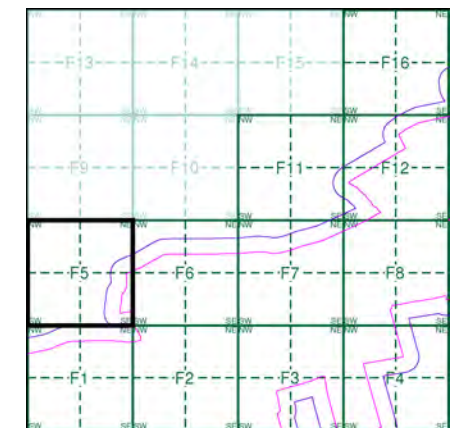

Order Details

Order Number: 297990210_1_1
 Customer Ref: 21-1088.04
 National Grid Reference: 486940, 382710
 Slice: F
 Site Area (Ha): 1120.8
 Search Buffer (m): 100

Site Details

Cottam

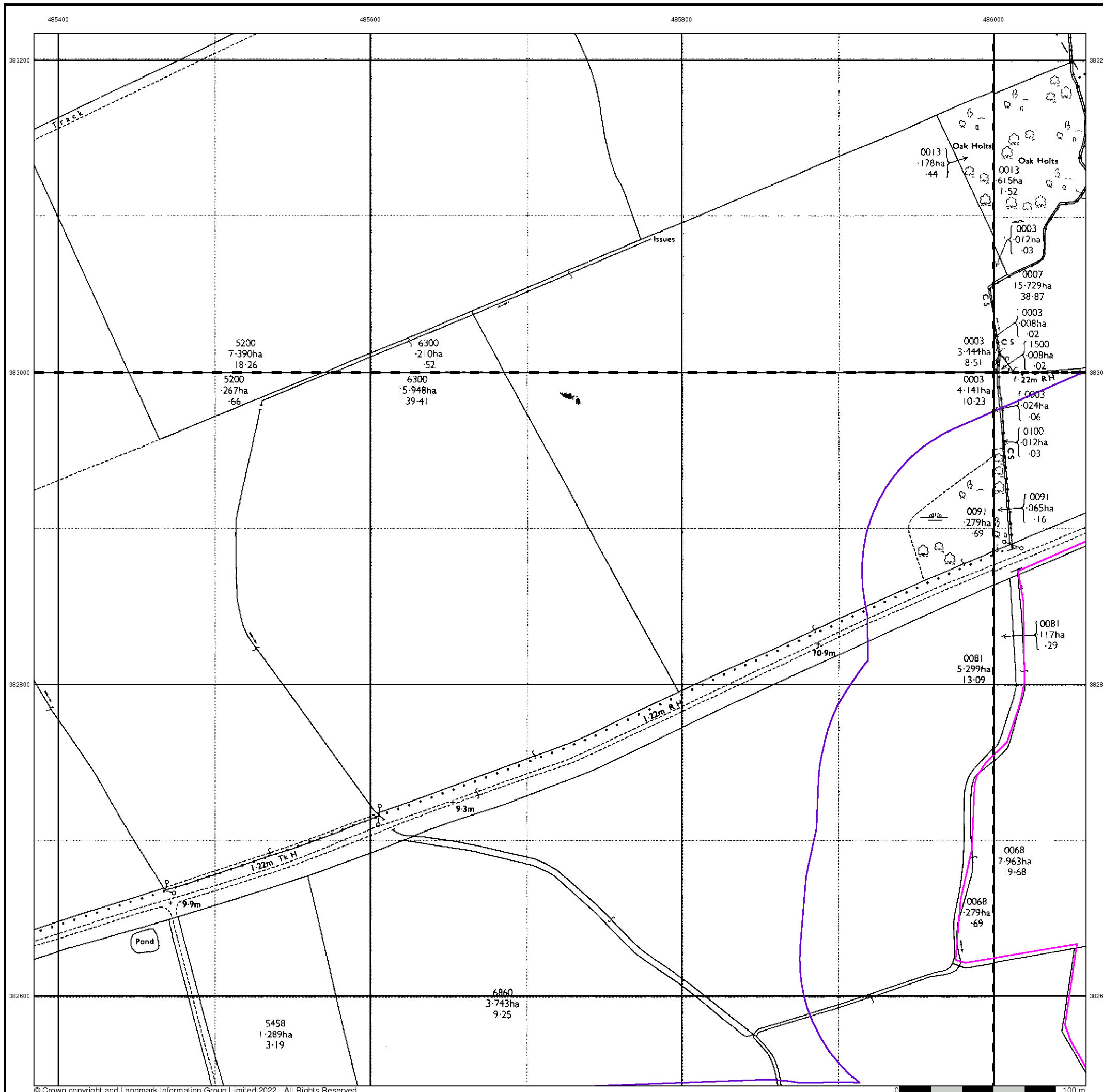

**Large-Scale National Grid Data
Published 1994
Source map scale - 1:2,500**

'Large Scale National Grid Data' superseded SIM cards (Ordnance Survey's 'Survey of Information on Microfilm') in 1992, and continued to be produced until 1999. These maps were the fore-runners of digital mapping and so provide detailed information on houses and roads, but tend to show less topographic features such as vegetation. These maps were produced at both 1:2,500 and 1:1,250 scales.

Map Name(s) and Date(s)

SK8583 1994 1:2,500	SK8683 1994 1:2,500
SK8582 1994 1:2,500	SK8682 1994 1:2,500

Historical Map - Segment F5

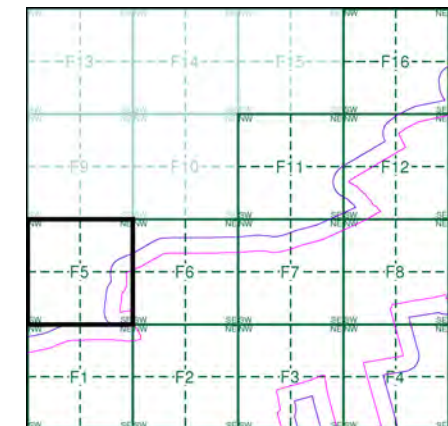

Order Details

Order Number: 297990210_1_1
 Customer Ref: 21-1088.04
 National Grid Reference: 486940, 382710
 Slice: F
 Site Area (Ha): 1120.8
 Search Buffer (m): 100

Site Details

Cottam

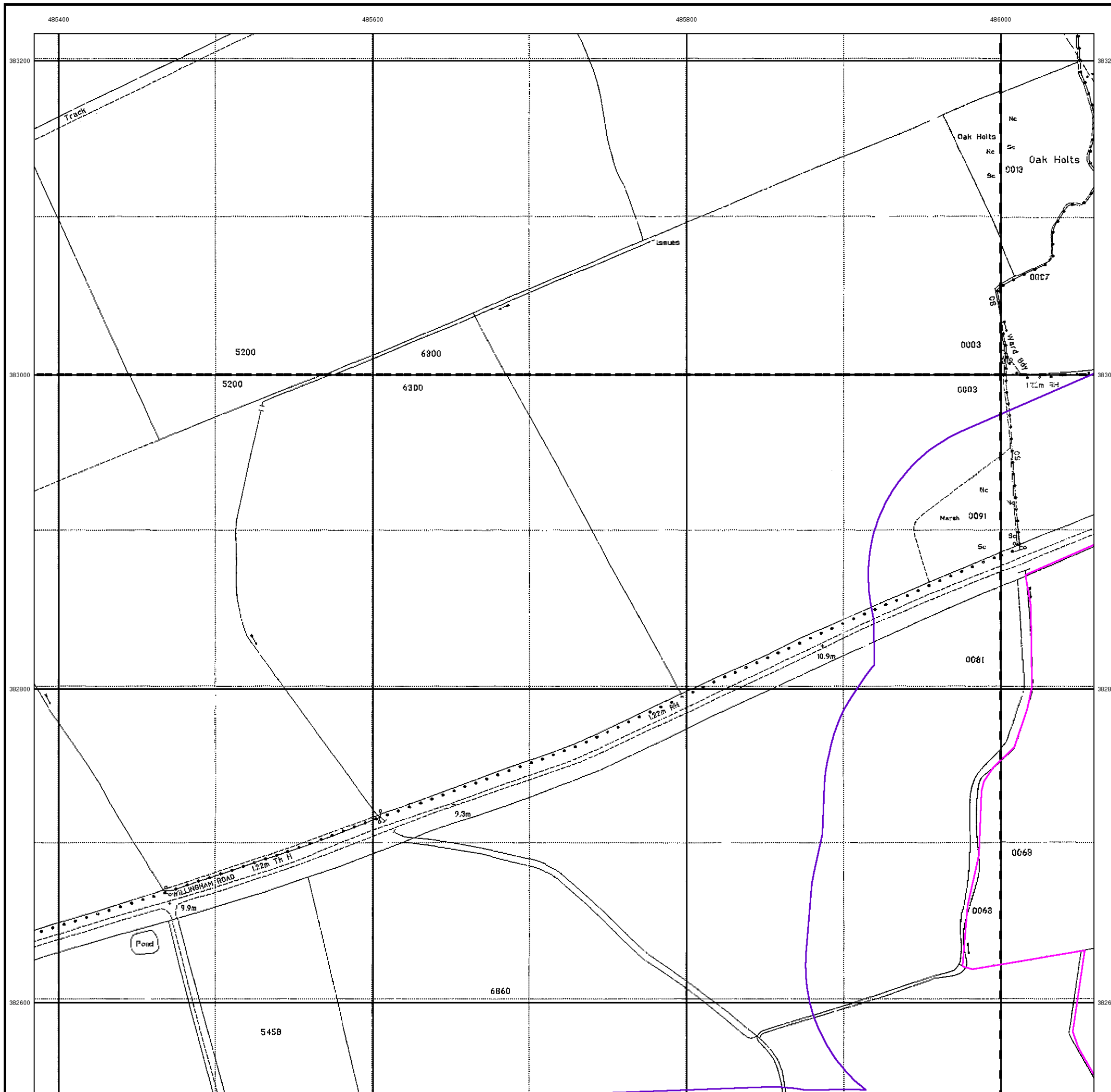

Historical Mapping Legends

Ordnance Survey County Series and Ordnance Survey Plan 1:2,500

Quarry **Gravel Pit** **Sand Pit**
Clay Pit **Shingle** **Refuse Heap**
Sloping Masonry **Flat Rock**
Marsh **Reeds** **Osiers**
Rough Pasture **Furze** **Wood**
Mixed Wood **Brushwood** **Orchard**
Fir **Ford** **Stepping Stones**
Ferry **Waterfall** **Lock**
Trig. Station **Altitude at Trig. Station**
B.M. 325.9 **Bench Mark** **Surface Level**
Arrow denotes flow of water **Antiquities (site of)**
Cutting **Embankment**
Railway crossing Road **Level Crossing** **Road crossing Railway**
Railway crossing River or Canal **Road over single stream** **Road over River or Canal**
County Boundary (Geographical)
County & Civil Parish Boundary
Administrative County & Civil Parish Boundary
County Borough Boundary (England)
Co. Boro. Bdy.
County Burgh Boundary (Scotland)
Boundary Post or Stone **Police Call Box**
B.R. **Bridle Road** **P** **Pump**
E.P. **Electricity Pylon** **S.P.** **Signal Post**
F.B. **Foot Bridge** **Sl.** **Sluice**
F.P. **Foot Path** **Sp.** **Spring**
G.P. **Guide Post or Board** **T.C.B.** **Telephone Call Box**
M.S. **Mile Stone** **Tr.** **Trough**
M.P. M.R. **Mooring Post or Ring** **W** **Well**

Ordnance Survey Plan, Additional SIMs and Supply of Unpublished Survey Information 1:2,500 and 1:1,250

Inactive Quarry, Chalk Pit or Clay Pit **Active Quarry, Chalk Pit or Clay Pit**
Rock **Boulders**
Cliff **Slopes** **Top**
Roofed Building **Glazed Roof Building**
Sloping Masonry **Archway**
Non-Coniferous Tree (surveyed) **Coniferous Tree (surveyed)**
Non-Coniferous Trees (not surveyed) **Coniferous Trees (not surveyed)**
Orchard Tree **Scrub** **Bracken**
Coppice, Osier **Reeds** **Marsh, Saltings**
Rough Grassland **Heath** **Culvert**
Direction of water flow **Bench Mark** **Antiquity (site of)**
Cave Entrance **Triangulation Station** **Electricity Pylon**
Electricity Transmission Line
County Boundary (Geographical)
County & Civil Parish Boundary
Civil Parish Boundary
Admin. County or County Bor. Boundary
London Borough Boundary
Symbol marking point where boundary mereing changes
BH **Beer House** **P** **Pillar, Pole or Post**
BP, BS **Boundary Post or Stone** **PO** **Post Office**
Cn, C **Capstan, Crane** **PC** **Public Convenience**
Chy **Chimney** **PH** **Public House**
D Fn **Drinking Fountain** **Pp** **Pump**
EI P **Electricity Pillar or Post** **SB, S Br** **Signal Box or Bridge**
FAP **Fire Alarm Pillar** **SP, SL** **Signal Post or Light**
FB **Foot Bridge** **Spr** **Spring**
GP **Guide Post** **Tk** **Tank or Track**
H **Hydrant or Hydraulic** **TCB** **Telephone Call Box**
LC **Level Crossing** **TCP** **Telephone Call Post**
MH **Manhole** **Tr** **Trough**
MP **Mile Post or Mooring Post** **Wr Pt, Wr T** **Water Point, Water Tap**
MS **Mile Stone** **W** **Well**
NTL **Normal Tidal Limit** **Wd Pp** **Wind Pump**

Large-Scale National Grid Data 1:2,500 and 1:1,250

Cliff **Slopes** **Top**
Rock **Rock (scattered)**
Boulders **Boulders (scattered)**
Positioned Boulder **Scree**
Non-Coniferous Tree (surveyed) **Coniferous Tree (surveyed)**
Non-Coniferous Trees (not surveyed) **Coniferous Trees (not surveyed)**
Orchard Tree **Scrub** **Bracken**
Coppice, Osier **Reeds** **Marsh, Saltings**
Rough Grassland **Heath** **Culvert**
Direction of water flow **Triangulation Station** **Antiquity (site of)**
Electricity Transmission Line **Electricity Pylon**
B.M. 231.60m **Bench Mark** **Buildings with Building Seed**
Roofed Building **Glazed Roof Building**
Civil parish/community boundary
District boundary
County boundary
Boundary post/stone
Boundary mereing symbol (note: these always appear in opposed pairs or groups of three)
Bks **Barracks** **P** **Pillar, Pole or Post**
Bty **Battery** **PO** **Post Office**
Cemy **Cemetery** **PC** **Public Convenience**
Chy **Chimney** **Pp** **Pump**
Cis **Cistern** **Ppg Sta** **Pumping Station**
Dismtd Rly **Dismantled Railway** **PW** **Place of Worship**
EI Gen Sta **Electricity Generating Station** **Sewage Ppg Sta** **Sewage Pumping Station**
EI P **Electricity Pole, Pillar** **SB, S Br** **Signal Box or Bridge**
EI Sub Sta **Electricity Sub Station** **SP, SL** **Signal Post or Light**
FB **Filter Bed** **Spr** **Spring**
Fn / D Fn **Fountain / Drinking Ftn.** **Tk** **Tank or Track**
Gas Gov **Gas Valve Compound** **Tr** **Trough**
GVC **Gas Governor** **Wd Pp** **Wind Pump**
GP **Guide Post** **Wr Pt, Wr T** **Water Point, Water Tap**
MH **Manhole** **Wks** **Works (building or area)**
MP, MS **Mile Post or Mile Stone** **W** **Well**



Historical Mapping & Photography included:

Mapping Type	Scale	Date	Pg
Lincolnshire	1:2,500	1886	2
Lincolnshire	1:2,500	1906	3
Lincolnshire	1:2,500	1920	4
Ordnance Survey Plan	1:2,500	1975	5
Large-Scale National Grid Data	1:2,500	1994	6

Historical Map - Segment F6

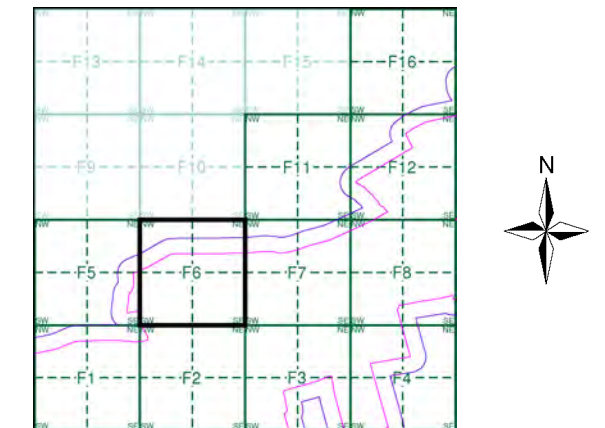

Order Details

Order Number: 297990210_1_1
Customer Ref: 21-1088.04
National Grid Reference: 486940, 382710
Slice: F
Site Area (Ha): 1120.8
Search Buffer (m): 100

Site Details

Cottam



Tel: [Redacted]
Fax: [Redacted]
Web: [Redacted]

Lincolnshire

Published 1886

Source map scale - 1:2,500

The historical maps shown were reproduced from maps predominantly held at the scale adopted for England, Wales and Scotland in the 1840's. In 1854 the 1:2,500 scale was adopted for mapping urban areas and by 1896 it covered the whole of what were considered to be the cultivated parts of Great Britain. The published date given below is often some years later than the surveyed date. Before 1938, all OS maps were based on the Cassini Projection, with independent surveys of a single county or group of counties, giving rise to significant inaccuracies in outlying areas.

Map Name(s) and Date(s)

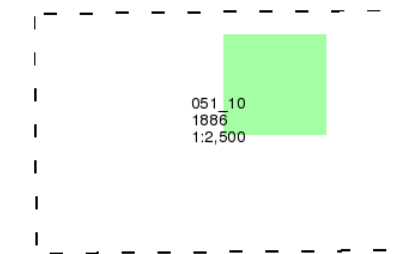

Historical Map - Segment F6

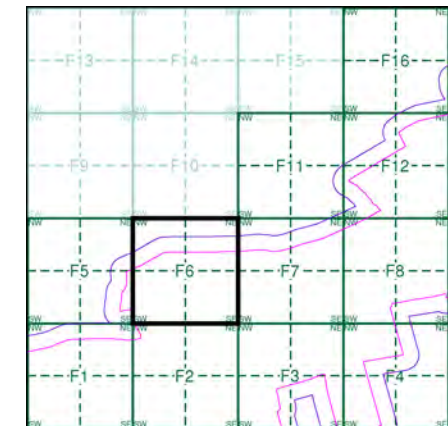

Order Details

Order Number: 297990210_1_1
 Customer Ref: 21-1088.04
 National Grid Reference: 486940, 382710
 Slice: F
 Site Area (Ha): 1120.8
 Search Buffer (m): 100

Site Details

Cottam

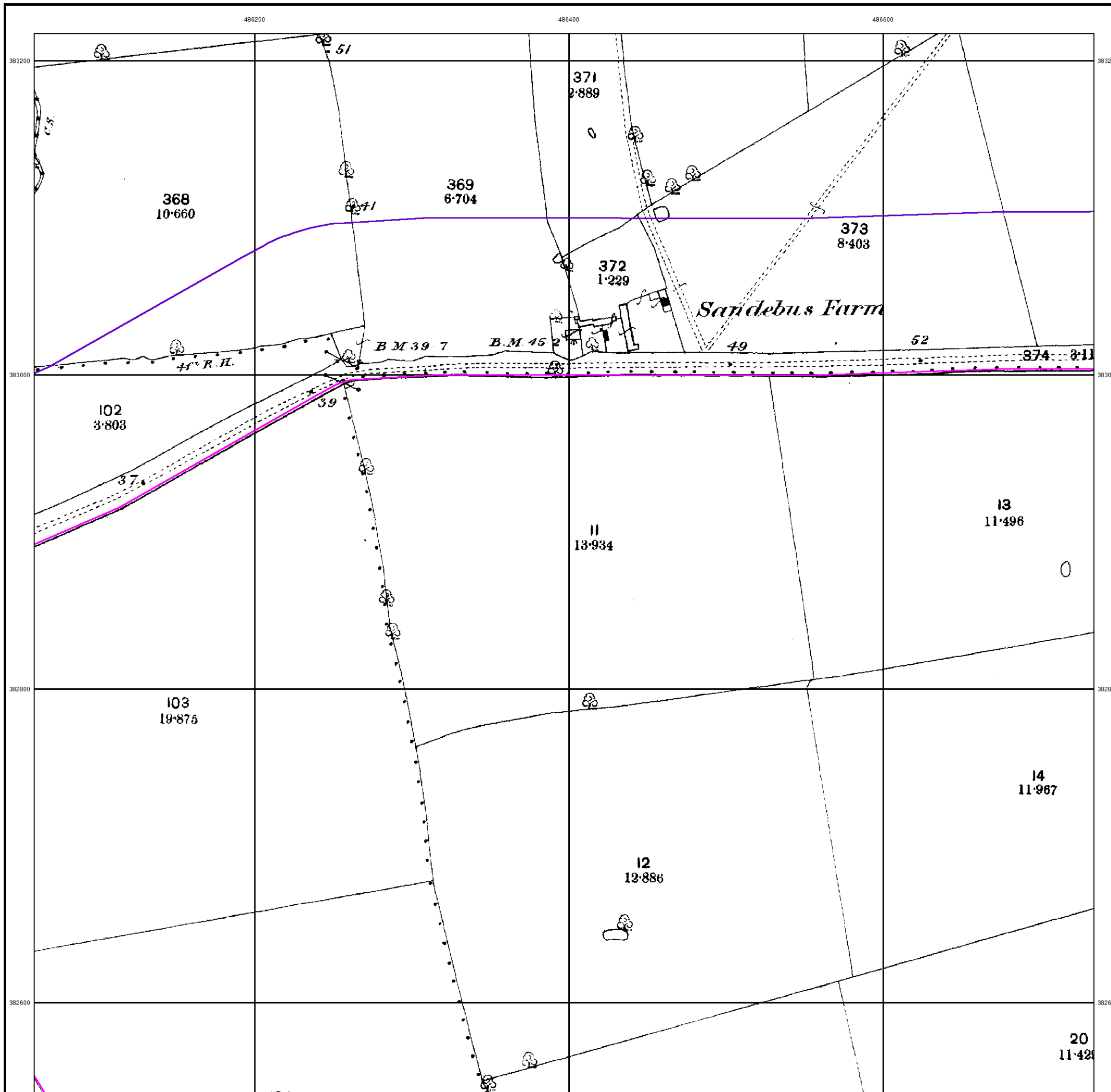

Lincolnshire

Published 1906

Source map scale - 1:2,500

The historical maps shown were reproduced from maps predominantly held at the scale adopted for England, Wales and Scotland in the 1840's. In 1854 the 1:2,500 scale was adopted for mapping urban areas and by 1896 it covered the whole of what were considered to be the cultivated parts of Great Britain. The published date given below is often some years later than the surveyed date. Before 1938, all OS maps were based on the Cassini Projection, with independent surveys of a single county or group of counties, giving rise to significant inaccuracies in outlying areas.

Map Name(s) and Date(s)

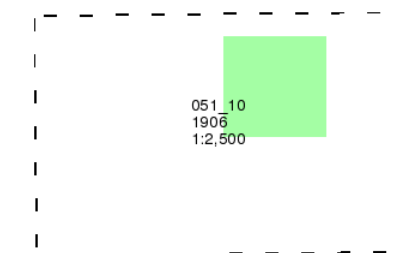

Historical Map - Segment F6

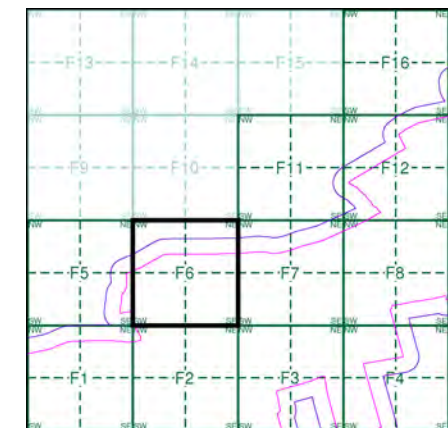

Order Details

Order Number: 297990210_1_1
 Customer Ref: 21-1088.04
 National Grid Reference: 486940, 382710
 Slice: F
 Site Area (Ha): 1120.8
 Search Buffer (m): 100

Site Details

Cottam

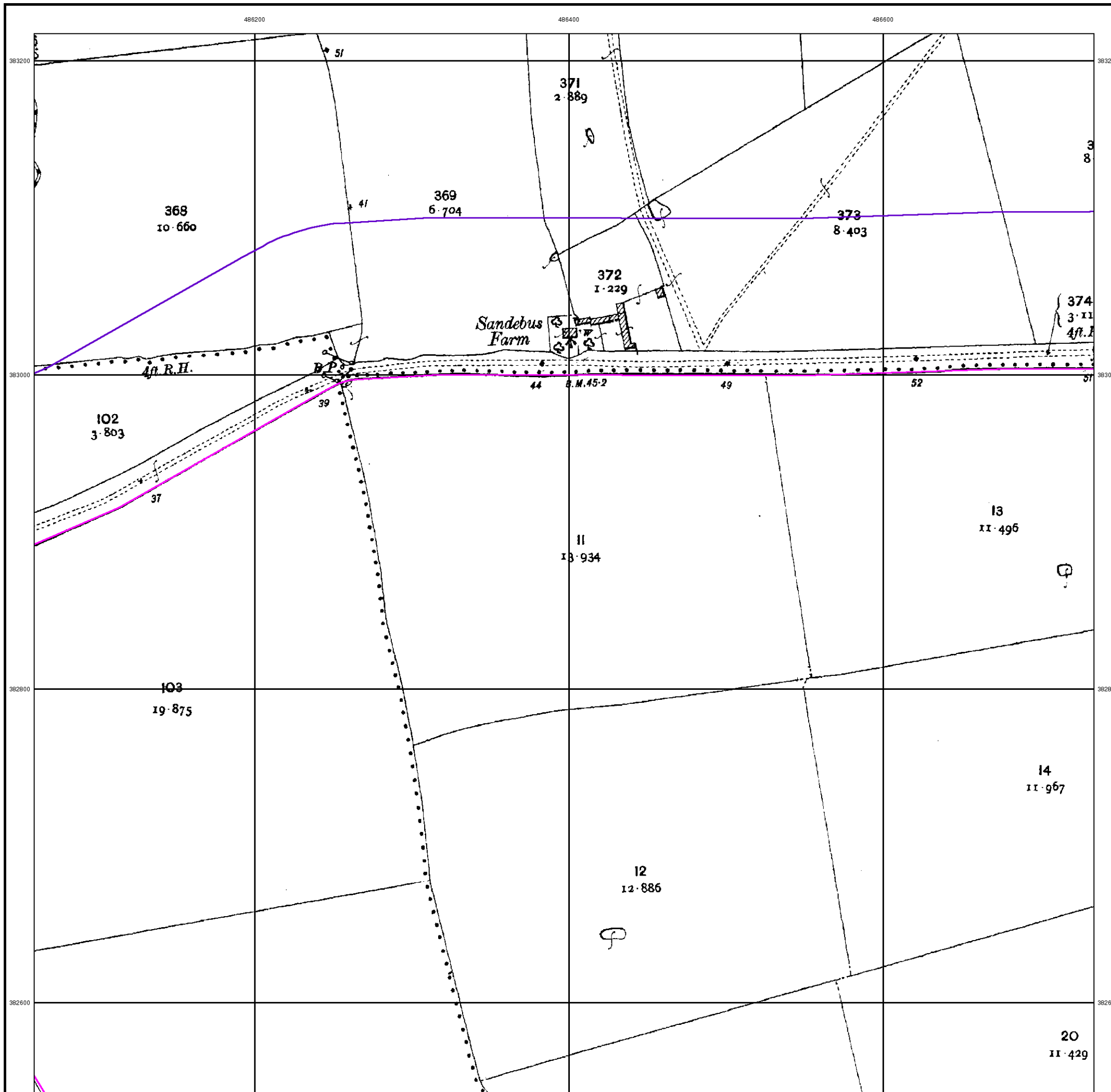

Lincolnshire

Published 1920

Source map scale - 1:2,500

The historical maps shown were reproduced from maps predominantly held at the scale adopted for England, Wales and Scotland in the 1840's. In 1854 the 1:2,500 scale was adopted for mapping urban areas and by 1896 it covered the whole of what were considered to be the cultivated parts of Great Britain. The published date given below is often some years later than the surveyed date. Before 1938, all OS maps were based on the Cassini Projection, with independent surveys of a single county or group of counties, giving rise to significant inaccuracies in outlying areas.

Map Name(s) and Date(s)

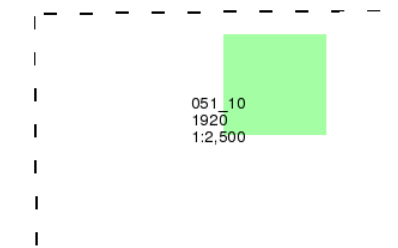

Historical Map - Segment F6

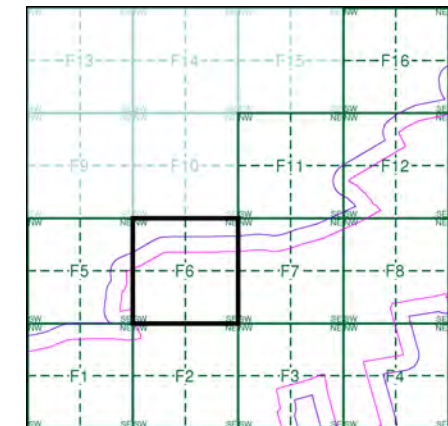

Order Details

Order Number: 297990210_1_1
 Customer Ref: 21-1088.04
 National Grid Reference: 486940, 382710
 Slice: F
 Site Area (Ha): 1120.8
 Search Buffer (m): 100

Site Details

Cottam

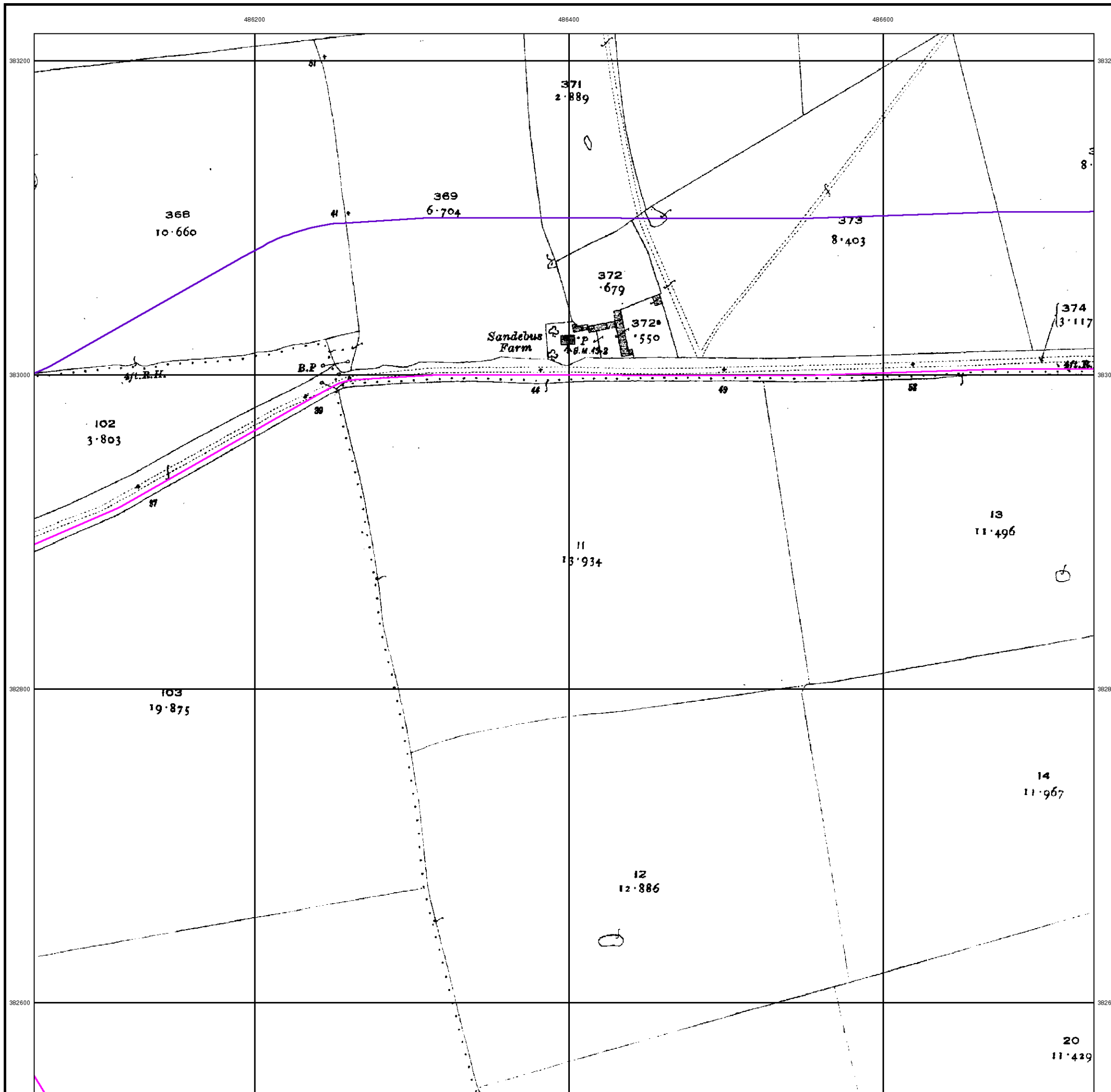

Ordnance Survey Plan

Published 1975

Source map scale - 1:2,500

The historical maps shown were reproduced from maps predominantly held at the scale adopted for England, Wales and Scotland in the 1840's. In 1854 the 1:2,500 scale was adopted for mapping urban areas and by 1896 it covered the whole of what were considered to be the cultivated parts of Great Britain. The published date given below is often some years later than the surveyed date. Before 1938, all OS maps were based on the Cassini Projection, with independent surveys of a single county or group of counties, giving rise to significant inaccuracies in outlying areas.

Map Name(s) and Date(s)

SK8683	1975	1:2,500
SK8682	1975	1:2,500

Historical Map - Segment F6

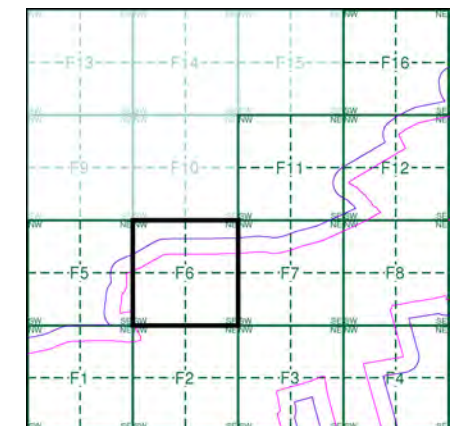

Order Details

Order Number: 297990210_1_1
 Customer Ref: 21-1088.04
 National Grid Reference: 486940, 382710
 Slice: F
 Site Area (Ha): 1120.8
 Search Buffer (m): 100

Site Details

Cottam

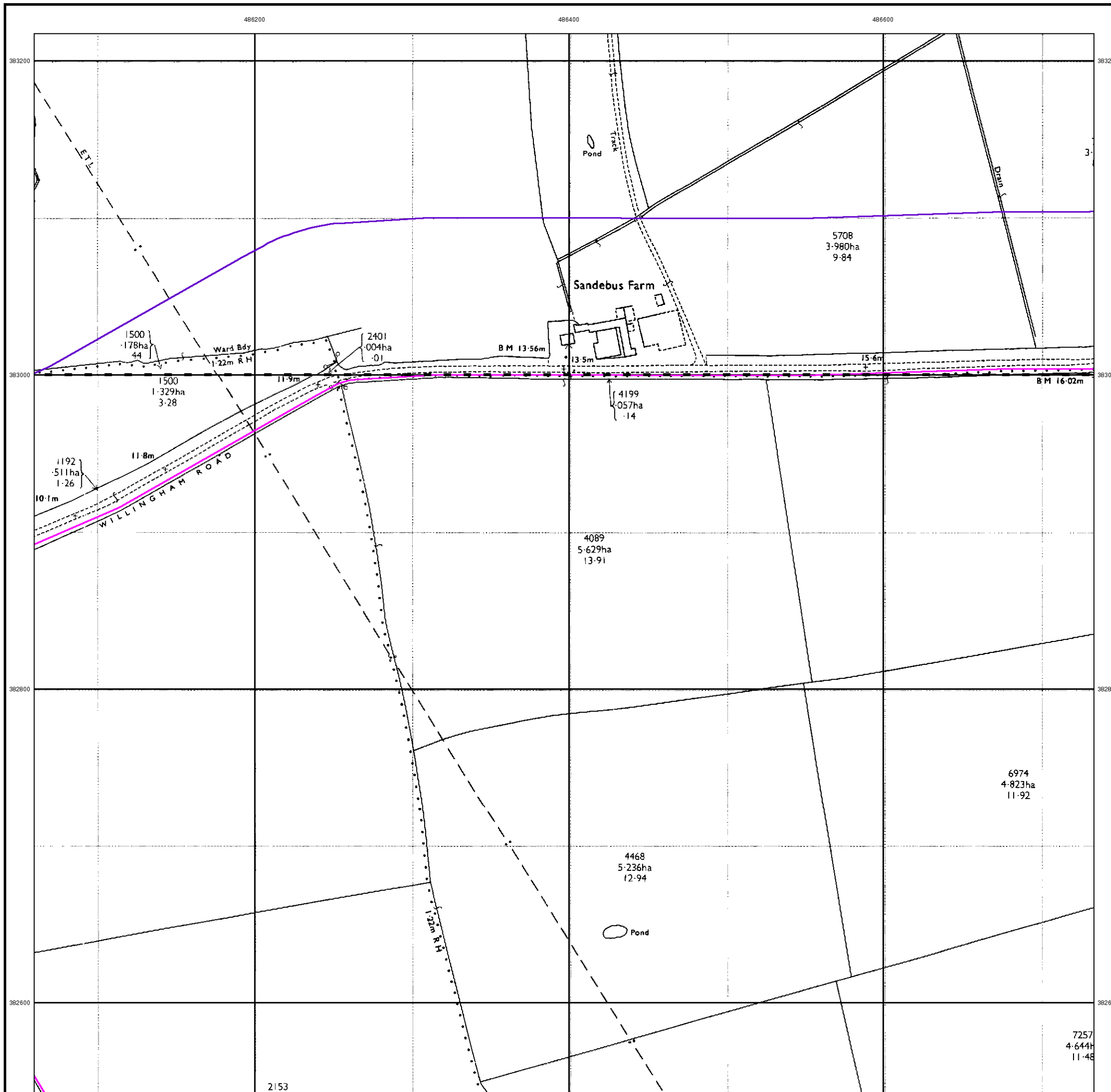

Large-Scale National Grid Data

Published 1994

Source map scale - 1:2,500

'Large Scale National Grid Data' superseded SIM cards (Ordnance Survey's 'Survey of Information on Microfilm') in 1992, and continued to be produced until 1999. These maps were the fore-runners of digital mapping and so provide detailed information on houses and roads, but tend to show less topographic features such as vegetation. These maps were produced at both 1:2,500 and 1:1,250 scales.

Map Name(s) and Date(s)

SK8683	1994	1:2,500
SK8682	1994	1:2,500

Historical Map - Segment F6

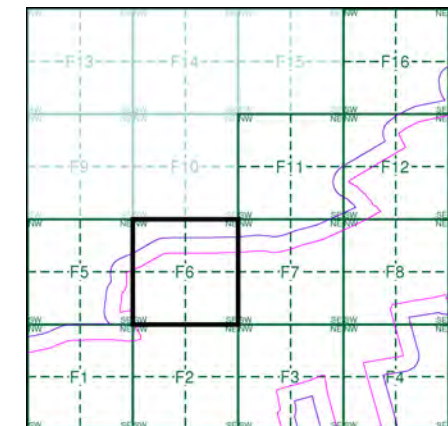

Order Details

Order Number: 297990210_1_1
 Customer Ref: 21-1088.04
 National Grid Reference: 486940, 382710
 Slice: F
 Site Area (Ha): 1120.8
 Search Buffer (m): 100

Site Details

Cottam

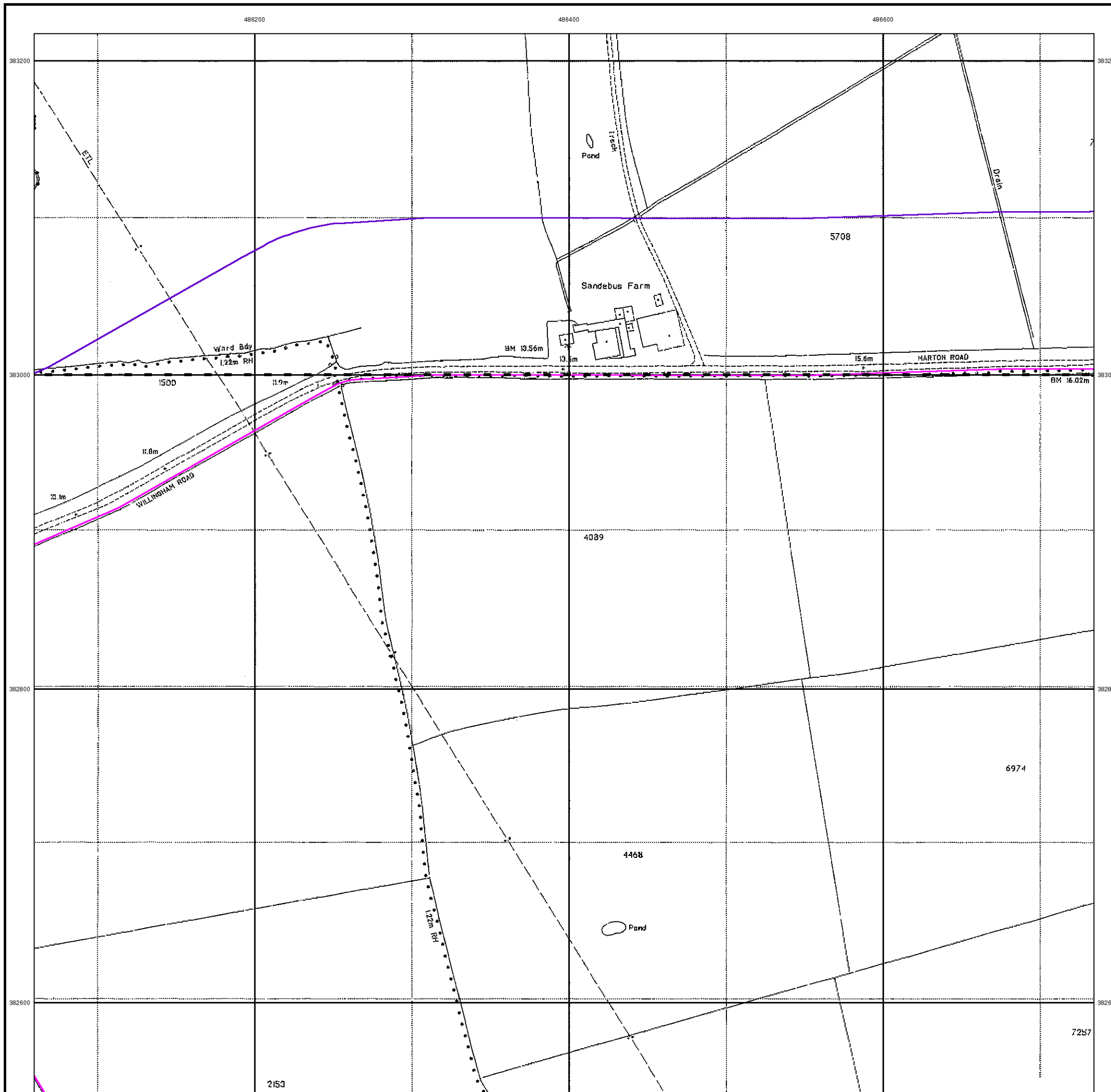

Historical Mapping Legends

Ordnance Survey County Series and Ordnance Survey Plan 1:2,500

Quarry **Gravel Pit** **Sand Pit**
Clay Pit **Shingle** **Refuse Heap**
Sloping Masonry **Flat Rock**
Marsh **Reeds** **Osiers**
Rough Pasture **Furze** **Wood**
Mixed Wood **Brushwood** **Orchard**
Fir **Ford** **Stepping Stones**
Ferry **Waterfall** **Lock**
Trig. Station **Altitude at Trig. Station**
B.M. 325.9 **Bench Mark** **Surface Level**
Arrow denotes flow of water **Antiquities (site of)**
Cutting **Embankment**
Railway crossing Road **Level Crossing** **Road crossing Railway**
Railway crossing River or Canal **Road over single stream** **Road over River or Canal**
County Boundary (Geographical)
County & Civil Parish Boundary
Administrative County & Civil Parish Boundary
County Borough Boundary (England)
County Burgh Boundary (Scotland)
Co. Boro. Bdy.
Co. Burgh Bdy.
BP BS Boundary Post or Stone **P.C.B** Police Call Box
B.R. Bridle Road **P** Pump
E.P Electricity Pylon **S.P** Signal Post
F.B. Foot Bridge **SL** Sluice
F.P. Foot Path **Sp.** Spring
G.P Guide Post or Board **T.C.B** Telephone Call Box
M.S Mile Stone **Tr.** Trough
M.P M.R Mooring Post or Ring **W** Well

Ordnance Survey Plan, Additional SIMs and Supply of Unpublished Survey Information 1:2,500 and 1:1,250

Inactive Quarry, Chalk Pit or Clay Pit **Active Quarry, Chalk Pit or Clay Pit**
Rock **Boulders**
Cliff **Slopes** **Top**
Roofed Building **Glazed Roof Building**
Sloping Masonry **Archway**
Non-Coniferous Tree (surveyed) **Coniferous Tree (surveyed)**
Non-Coniferous Trees (not surveyed) **Coniferous Trees (not surveyed)**
Orchard Tree **Scrub** **Bracken**
Coppice, Osier **Reeds** **Marsh, Saltings**
Rough Grassland **Heath** **Culvert**
Direction of water flow **Bench Mark** **Antiquity (site of)**
Cave Entrance **Triangulation Station** **Electricity Pylon**
Electricity Transmission Line
County Boundary (Geographical)
County & Civil Parish Boundary
Civil Parish Boundary
Admin. County or County Bor. Boundary
London Borough Boundary
Symbol marking point where boundary mereing changes
BH Beer House **P** Pillar, Pole or Post
BP, BS Boundary Post or Stone **PO** Post Office
Cn, C Capstan, Crane **PC** Public Convenience
Chy Chimney **PH** Public House
D Fn Drinking Fountain **Pp** Pump
EI P Electricity Pillar or Post **SB, S Br** Signal Box or Bridge
FAP Fire Alarm Pillar **SP, SL** Signal Post or Light
FB Foot Bridge **Spr** Spring
GP Guide Post **Tk** Tank or Track
H Hydrant or Hydraulic **TCB** Telephone Call Box
LC Level Crossing **TCP** Telephone Call Post
MH Manhole **Tr** Trough
MP Mile Post or Mooring Post **Wr Pt, Wr T** Water Point, Water Tap
MS Mile Stone **W** Well
NTL Normal Tidal Limit **Wd Pp** Wind Pump

Large-Scale National Grid Data 1:2,500 and 1:1,250

Cliff **Slopes** **Top**
Rock **Rock (scattered)**
Boulders **Boulders (scattered)**
Positioned Boulder **Scree**
Non-Coniferous Tree (surveyed) **Coniferous Tree (surveyed)**
Non-Coniferous Trees (not surveyed) **Coniferous Trees (not surveyed)**
Orchard Tree **Scrub** **Bracken**
Coppice, Osier **Reeds** **Marsh, Saltings**
Rough Grassland **Heath** **Culvert**
Direction of water flow **Triangulation Station** **Antiquity (site of)**
Electricity Transmission Line **Electricity Pylon**
BM 231.60m Bench Mark **Buildings with Building Seed**
Roofed Building **Glazed Roof Building**
Civil parish/community boundary
District boundary
County boundary
Boundary post/stone
Boundary mereing symbol (note: these always appear in opposed pairs or groups of three)
Bks Barracks **P** Pillar, Pole or Post
Bty Battery **PO** Post Office
Cemy Cemetery **PC** Public Convenience
Chy Chimney **Pp** Pump
Cis Cistern **Ppg Sta** Pumping Station
Dismtd Rly Dismantled Railway **PW** Place of Worship
EI Gen Sta Electricity Generating Station **Sewage Ppg Sta** Sewage Pumping Station
EI P Electricity Pole, Pillar **SB, S Br** Signal Box or Bridge
EI Sub Sta Electricity Sub Station **SP, SL** Signal Post or Light
FB Filter Bed **Spr** Spring
Fn / D Fn Fountain / Drinking Ftn. **Tk** Tank or Track
Gas Gov Gas Valve Compound **Tr** Trough
GVC Gas Governor **Wd Pp** Wind Pump
GP Guide Post **Wr Pt, Wr T** Water Point, Water Tap
MH Manhole **Wks** Works (building or area)
MP, MS Mile Post or Mile Stone **W** Well



Historical Mapping & Photography included:

Mapping Type	Scale	Date	Pg
Lincolnshire	1:2,500	1886	2
Lincolnshire	1:2,500	1906	3
Lincolnshire	1:2,500	1920	4
Ordnance Survey Plan	1:2,500	1975	5
Large-Scale National Grid Data	1:2,500	1994	6

Historical Map - Segment F7

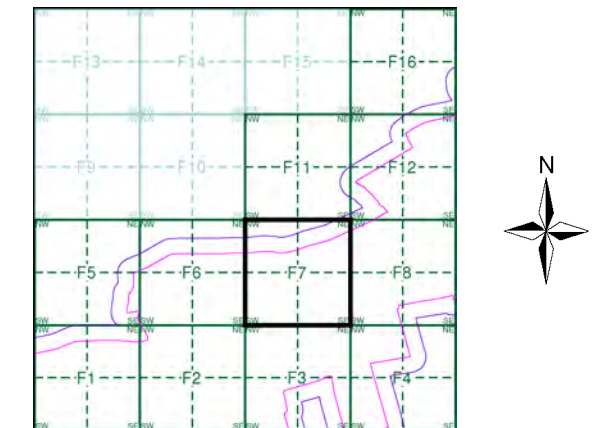

Order Details

Order Number: 297990210_1_1
 Customer Ref: 21-1088.04
 National Grid Reference: 486940, 382710
 Slice: F
 Site Area (Ha): 1120.8
 Search Buffer (m): 100

Site Details

Cottam



Tel: [Redacted]
 Fax: [Redacted]
 Web: [Redacted]

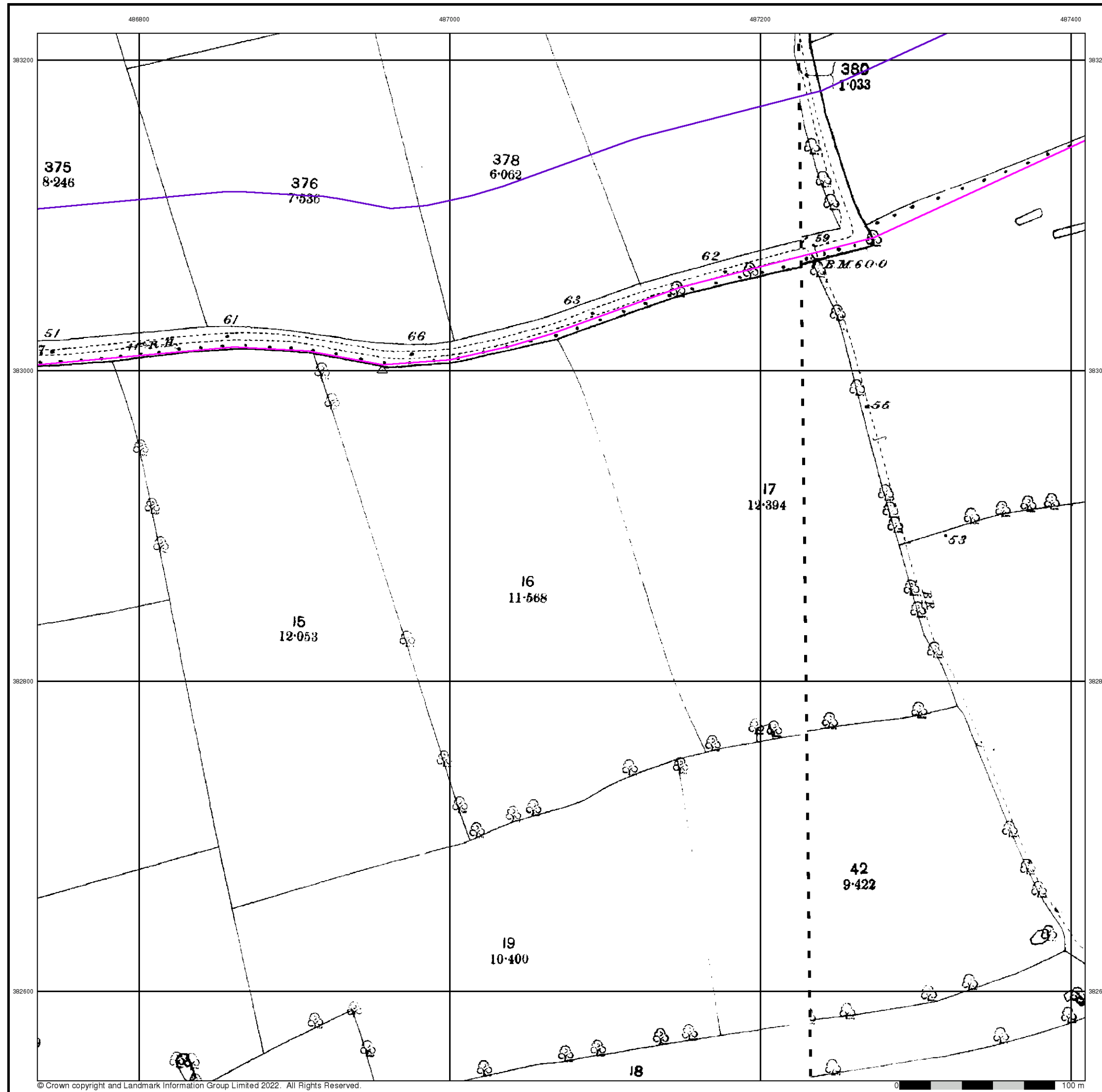

Lincolnshire
Published 1886
Source map scale - 1:2,500

The historical maps shown were reproduced from maps predominantly held at the scale adopted for England, Wales and Scotland in the 1840's. In 1854 the 1:2,500 scale was adopted for mapping urban areas and by 1896 it covered the whole of what were considered to be the cultivated parts of Great Britain. The published date given below is often some years later than the surveyed date. Before 1938, all OS maps were based on the Cassini Projection, with independent surveys of a single county or group of counties, giving rise to significant inaccuracies in outlying areas.

Map Name(s) and Date(s)

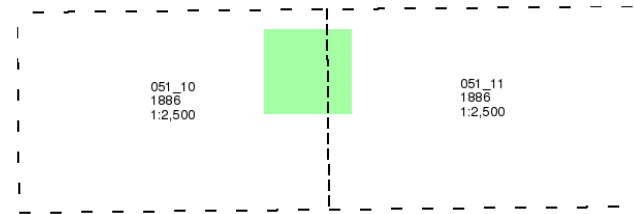

Historical Map - Segment F7

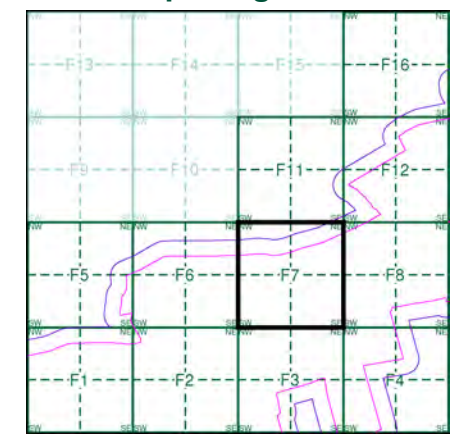

Order Details
 Order Number: 297990210_1_1
 Customer Ref: 21-1088.04
 National Grid Reference: 486940, 382710
 Slice: F
 Site Area (Ha): 1120.8
 Search Buffer (m): 100

Site Details
 Cottam



Lincolnshire

Published 1906

Source map scale - 1:2,500

The historical maps shown were reproduced from maps predominantly held at the scale adopted for England, Wales and Scotland in the 1840's. In 1854 the 1:2,500 scale was adopted for mapping urban areas and by 1896 it covered the whole of what were considered to be the cultivated parts of Great Britain. The published date given below is often some years later than the surveyed date. Before 1938, all OS maps were based on the Cassini Projection, with independent surveys of a single county or group of counties, giving rise to significant inaccuracies in outlying areas.

Map Name(s) and Date(s)

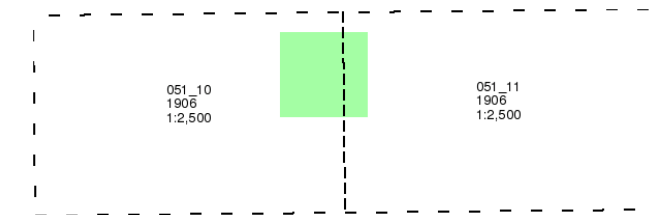

Historical Map - Segment F7

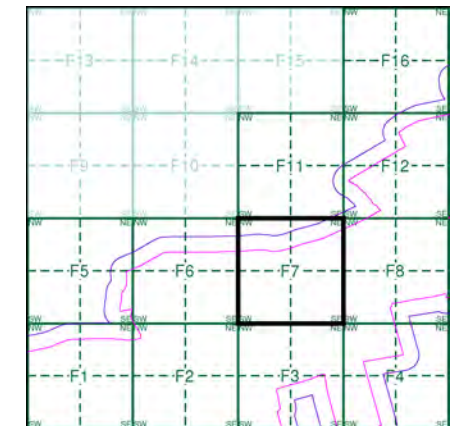

Order Details

Order Number: 297990210_1_1
 Customer Ref: 21-1088.04
 National Grid Reference: 486940, 382710
 Slice: F
 Site Area (Ha): 1120.8
 Search Buffer (m): 100

Site Details

Cottam

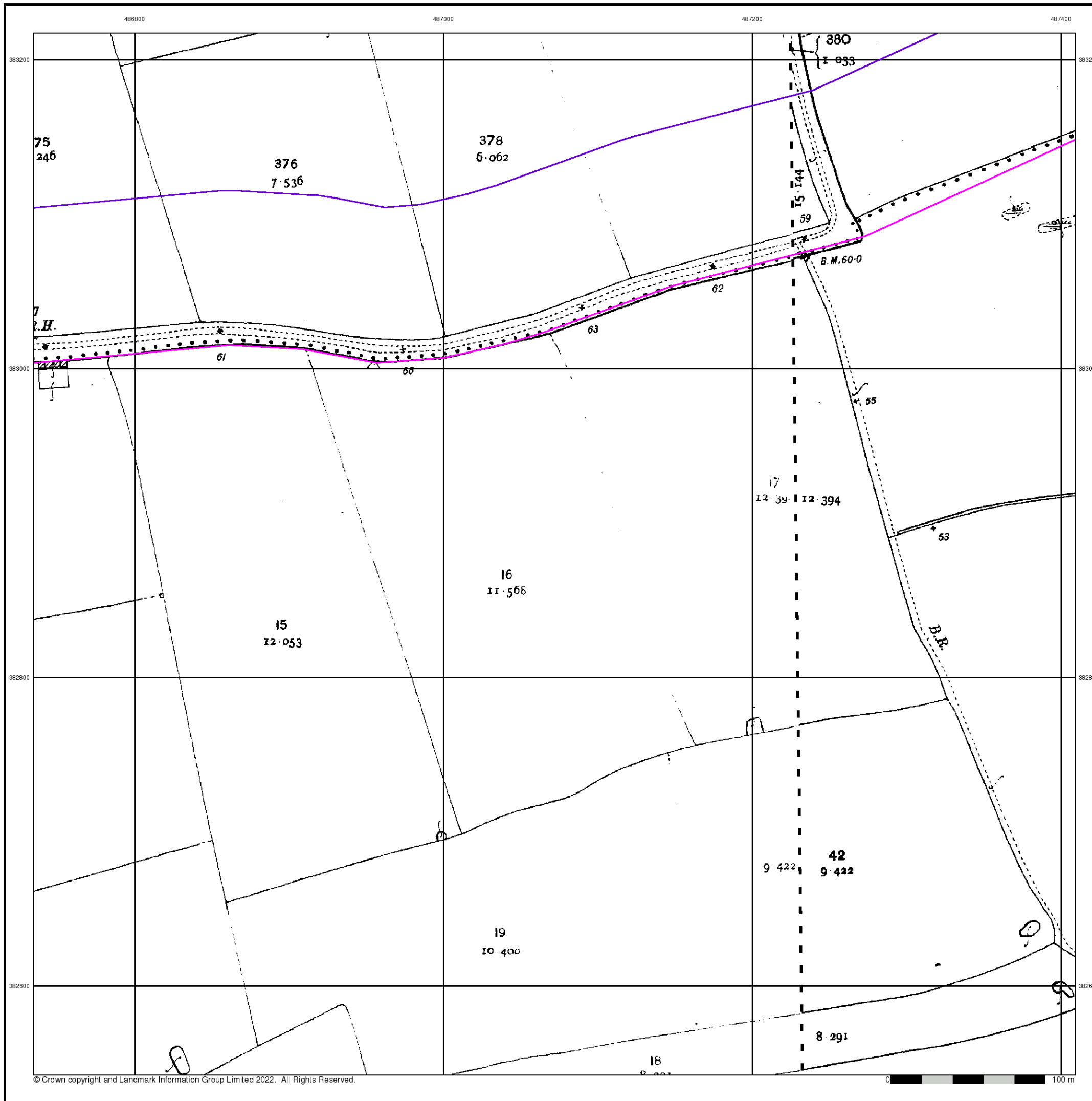

Lincolnshire

Published 1920

Source map scale - 1:2,500

The historical maps shown were reproduced from maps predominantly held at the scale adopted for England, Wales and Scotland in the 1840's. In 1854 the 1:2,500 scale was adopted for mapping urban areas and by 1896 it covered the whole of what were considered to be the cultivated parts of Great Britain. The published date given below is often some years later than the surveyed date. Before 1938, all OS maps were based on the Cassini Projection, with independent surveys of a single county or group of counties, giving rise to significant inaccuracies in outlying areas.

Map Name(s) and Date(s)

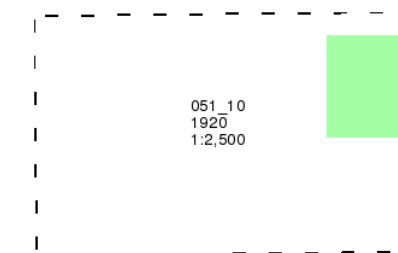

Historical Map - Segment F7

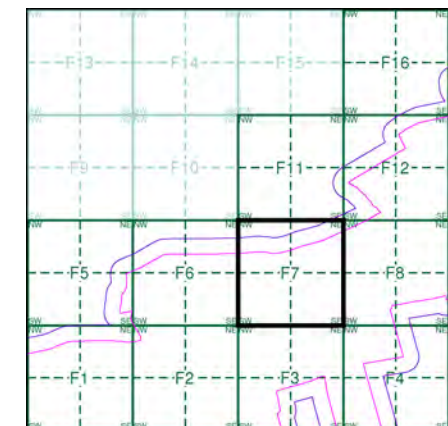

Order Details

Order Number: 297990210_1_1
 Customer Ref: 21-1088.04
 National Grid Reference: 486940, 382710
 Slice: F
 Site Area (Ha): 1120.8
 Search Buffer (m): 100

Site Details

Cottam

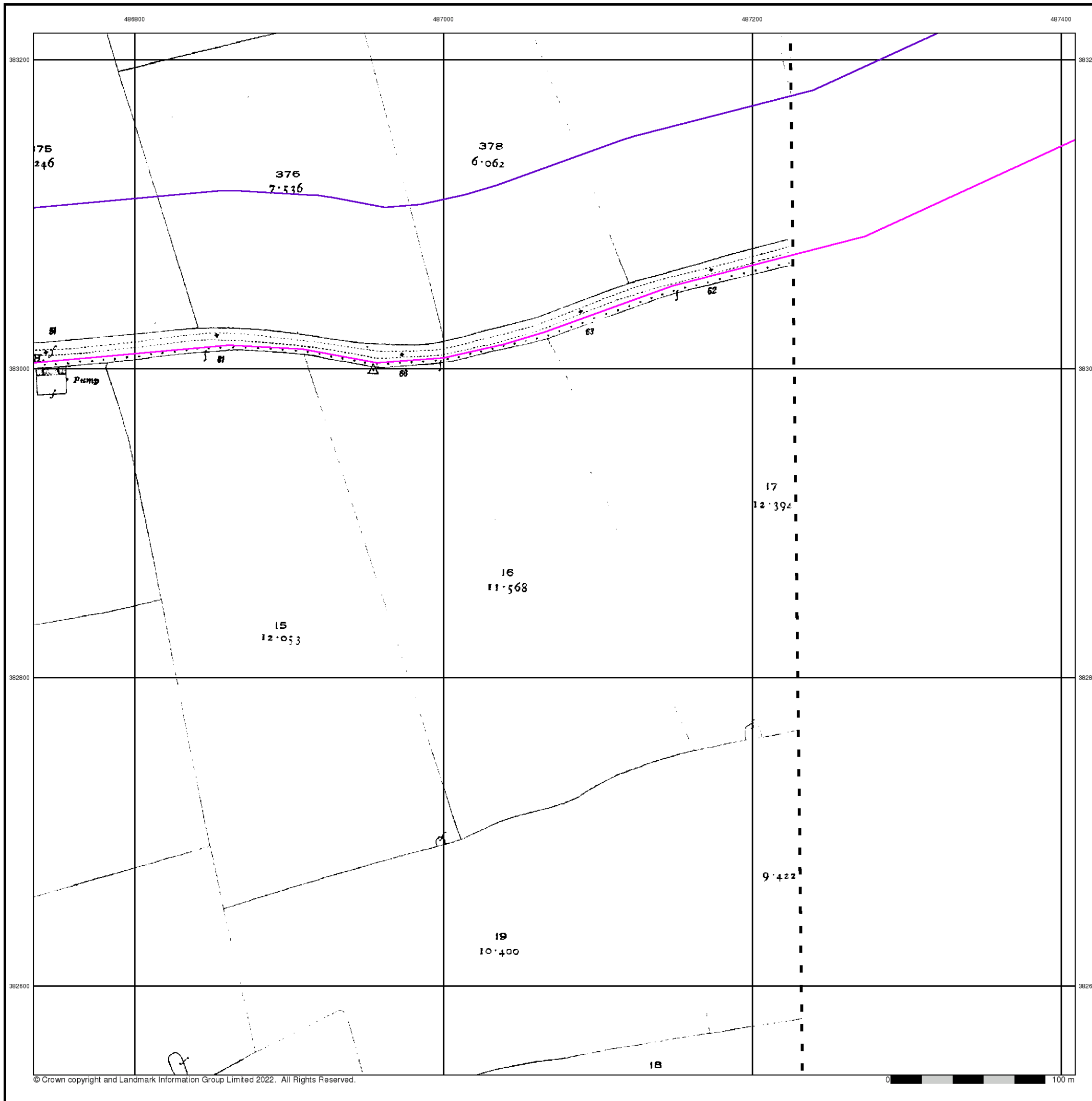

Ordnance Survey Plan

Published 1975

Source map scale - 1:2,500

The historical maps shown were reproduced from maps predominantly held at the scale adopted for England, Wales and Scotland in the 1840's. In 1854 the 1:2,500 scale was adopted for mapping urban areas and by 1896 it covered the whole of what were considered to be the cultivated parts of Great Britain. The published date given below is often some years later than the surveyed date. Before 1938, all OS maps were based on the Cassini Projection, with independent surveys of a single county or group of counties, giving rise to significant inaccuracies in outlying areas.

Map Name(s) and Date(s)

SK8683 1975 1:2,500	SK8783 1975 1:2,500
SK8682 1975 1:2,500	SK8782 1975 1:2,500

Historical Map - Segment F7

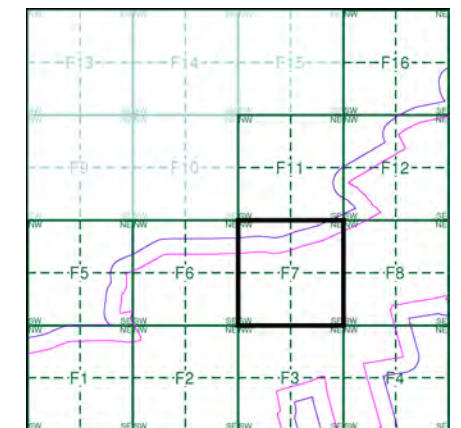

Order Details

Order Number: 297990210_1_1
 Customer Ref: 21-1088.04
 National Grid Reference: 486940, 382710
 Slice: F
 Site Area (Ha): 1120.8
 Search Buffer (m): 100

Site Details

Cottam

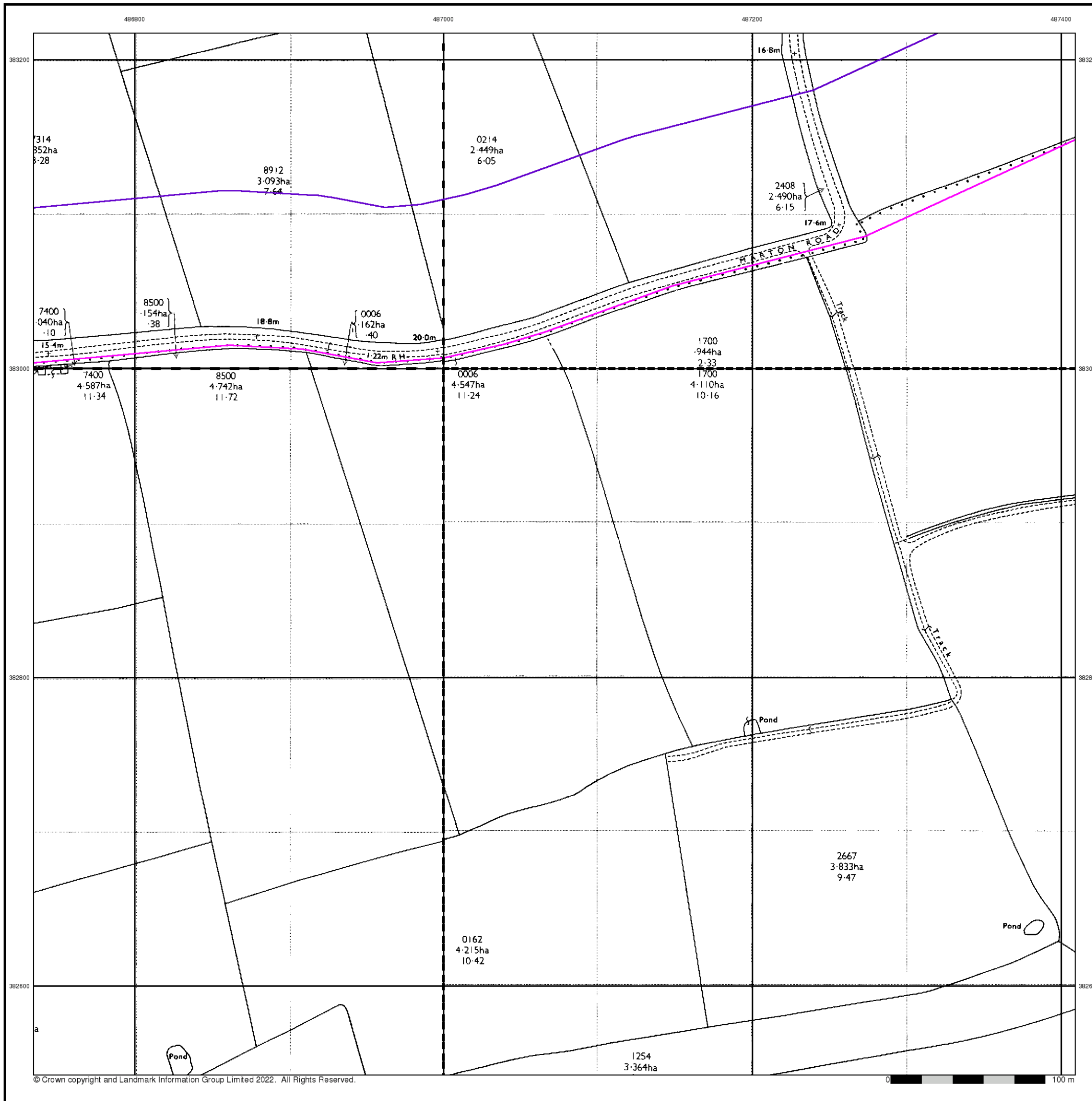

Large-Scale National Grid Data

Published 1994

Source map scale - 1:2,500

'Large Scale National Grid Data' superseded SIM cards (Ordnance Survey's 'Survey of Information on Microfilm') in 1992, and continued to be produced until 1999. These maps were the fore-runners of digital mapping and so provide detailed information on houses and roads, but tend to show less topographic features such as vegetation. These maps were produced at both 1:2,500 and 1:1,250 scales.

Map Name(s) and Date(s)

SK8683	SK8783
1994	1994
1:2,500	1:2,500
SK8682	SK8782
1994	1994
1:2,500	1:2,500

Historical Map - Segment F7

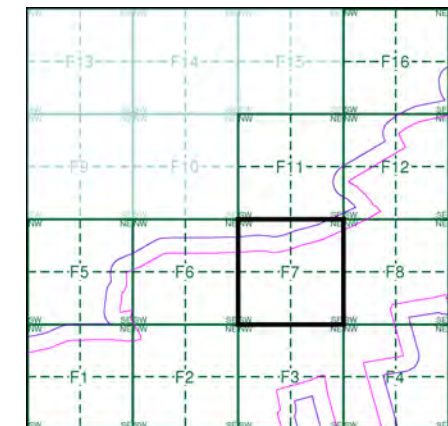

Order Details

Order Number: 297990210_1_1
 Customer Ref: 21-1088.04
 National Grid Reference: 486940, 382710
 Slice: F
 Site Area (Ha): 1120.8
 Search Buffer (m): 100

Site Details

Cottam

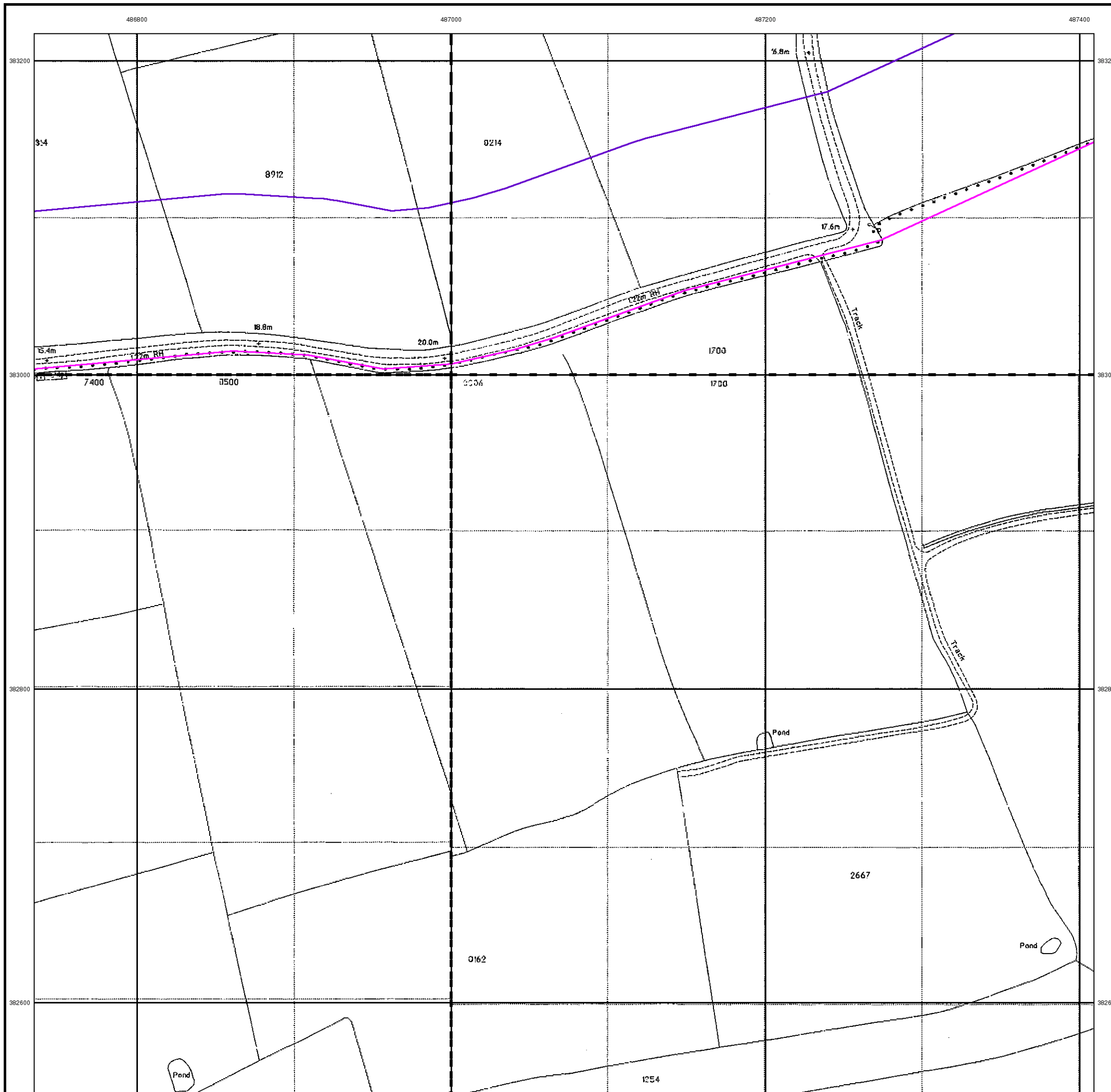

Historical Mapping Legends

Ordnance Survey County Series and Ordnance Survey Plan 1:2,500

Quarry **Gravel Pit** **Sand Pit**
Clay Pit **Shingle** **Refuse Heap**
Sloping Masonry **Flat Rock**
Marsh **Reeds** **Osiers**
Rough Pasture **Furze** **Wood**
Mixed Wood **Brushwood** **Orchard**
Fir **Ford** **Stepping Stones**
Ferry **Waterfall** **Lock**
Trig. Station **Altitude at Trig. Station**
B.M. 325.9 **Bench Mark** **Surface Level**
Arrow denotes flow of water **Antiquities (site of)**
Cutting **Embankment**
Railway crossing Road **Level Crossing** **Road crossing Railway**
Railway crossing River or Canal **Road over single stream** **Road over River or Canal**
County Boundary (Geographical)
County & Civil Parish Boundary
Administrative County & Civil Parish Boundary
County Borough Boundary (England)
Co. Boro. Bdy.
County Burgh Boundary (Scotland)
Boundary Post or Stone **Police Call Box**
B.R. **Bridle Road** **P** **Pump**
E.P. **Electricity Pylon** **S.P.** **Signal Post**
F.B. **Foot Bridge** **Sl.** **Sluice**
F.P. **Foot Path** **Sp.** **Spring**
G.P. **Guide Post or Board** **T.C.B.** **Telephone Call Box**
M.S. **Mile Stone** **Tr.** **Trough**
M.P. M.R. **Mooring Post or Ring** **W** **Well**

Ordnance Survey Plan, Additional SIMs and Supply of Unpublished Survey Information 1:2,500 and 1:1,250

Inactive Quarry, Chalk Pit or Clay Pit **Active Quarry, Chalk Pit or Clay Pit**
Rock **Boulders**
Cliff **Slopes** **Top**
Roofed Building **Glazed Roof Building**
Sloping Masonry **Archway**
Non-Coniferous Tree (surveyed) **Coniferous Tree (surveyed)**
Non-Coniferous Trees (not surveyed) **Coniferous Trees (not surveyed)**
Orchard Tree **Scrub** **Bracken**
Coppice, Osier **Reeds** **Marsh, Saltings**
Rough Grassland **Heath** **Culvert**
Direction of water flow **Bench Mark** **Antiquity (site of)**
Cave Entrance **Triangulation Station** **Electricity Pylon**
Electricity Transmission Line
County Boundary (Geographical)
County & Civil Parish Boundary
Civil Parish Boundary
Admin. County or County Bor. Boundary
London Borough Boundary
Symbol marking point where boundary mereing changes
BH **Beer House** **P** **Pillar, Pole or Post**
BP, BS **Boundary Post or Stone** **PO** **Post Office**
Cn, C **Capstan, Crane** **PC** **Public Convenience**
Chy **Chimney** **PH** **Public House**
D Fn **Drinking Fountain** **Pp** **Pump**
EI P **Electricity Pillar or Post** **SB, S Br** **Signal Box or Bridge**
FAP **Fire Alarm Pillar** **SP, SL** **Signal Post or Light**
FB **Foot Bridge** **Spr** **Spring**
GP **Guide Post** **Tk** **Tank or Track**
H **Hydrant or Hydraulic** **TCB** **Telephone Call Box**
LC **Level Crossing** **TCP** **Telephone Call Post**
MH **Manhole** **Tr** **Trough**
MP **Mile Post or Mooring Post** **Wr Pt, Wr T** **Water Point, Water Tap**
MS **Mile Stone** **W** **Well**
NTL **Normal Tidal Limit** **Wd Pp** **Wind Pump**

Large-Scale National Grid Data 1:2,500 and 1:1,250

Cliff **Slopes** **Top**
Rock **Rock (scattered)**
Boulders **Boulders (scattered)**
Positioned Boulder **Scree**
Non-Coniferous Tree (surveyed) **Coniferous Tree (surveyed)**
Non-Coniferous Trees (not surveyed) **Coniferous Trees (not surveyed)**
Orchard Tree **Scrub** **Bracken**
Coppice, Osier **Reeds** **Marsh, Saltings**
Rough Grassland **Heath** **Culvert**
Direction of water flow **Triangulation Station** **Antiquity (site of)**
Electricity Transmission Line **Electricity Pylon**
B.M. 231.60m **Bench Mark** **Buildings with Building Seed**
Roofed Building **Glazed Roof Building**
Civil parish/community boundary
District boundary
County boundary
Boundary post/stone
Boundary mereing symbol (note: these always appear in opposed pairs or groups of three)
Bks **Barracks** **P** **Pillar, Pole or Post**
Bty **Battery** **PO** **Post Office**
Cemy **Cemetery** **PC** **Public Convenience**
Chy **Chimney** **Pp** **Pump**
Cis **Cistern** **Ppg Sta** **Pumping Station**
Dismtd Rly **Dismantled Railway** **PW** **Place of Worship**
EI Gen Sta **Electricity Generating Station** **Sewage Ppg Sta** **Sewage Pumping Station**
EI P **Electricity Pole, Pillar** **SB, S Br** **Signal Box or Bridge**
EI Sub Sta **Electricity Sub Station** **SP, SL** **Signal Post or Light**
FB **Filter Bed** **Spr** **Spring**
Fn / D Fn **Fountain / Drinking Ftn.** **Tk** **Tank or Track**
Gas Gov **Gas Valve Compound** **Tr** **Trough**
GVC **Gas Governor** **Wd Pp** **Wind Pump**
GP **Guide Post** **Wr Pt, Wr T** **Water Point, Water Tap**
MH **Manhole** **Wks** **Works (building or area)**
MP, MS **Mile Post or Mile Stone** **W** **Well**



Historical Mapping & Photography included:

Mapping Type	Scale	Date	Pg
Lincolnshire	1:2,500	1886	2
Lincolnshire	1:2,500	1906	3
Ordnance Survey Plan	1:2,500	1975	4
Large-Scale National Grid Data	1:2,500	1994	5

Historical Map - Segment F8

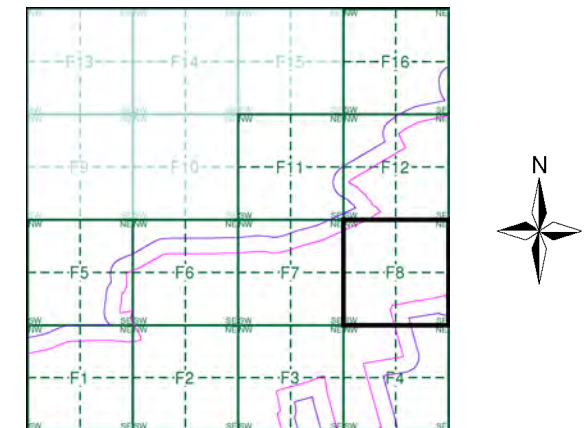

Order Details

Order Number: 297990210_1_1
Customer Ref: 21-1088.04
National Grid Reference: 486940, 382710
Slice: F
Site Area (Ha): 1120.8
Search Buffer (m): 100

Site Details

Cottam



Tel:
Fax:
Web:

Lincolnshire
Published 1886

Source map scale - 1:2,500

The historical maps shown were reproduced from maps predominantly held at the scale adopted for England, Wales and Scotland in the 1840's. In 1854 the 1:2,500 scale was adopted for mapping urban areas and by 1896 it covered the whole of what were considered to be the cultivated parts of Great Britain. The published date given below is often some years later than the surveyed date. Before 1938, all OS maps were based on the Cassini Projection, with independent surveys of a single county or group of counties, giving rise to significant inaccuracies in outlying areas.

Map Name(s) and Date(s)

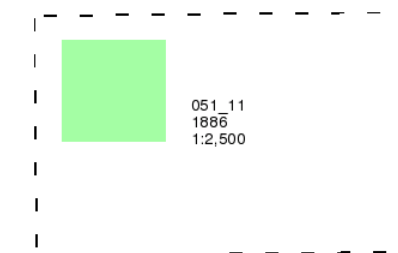

Historical Map - Segment F8

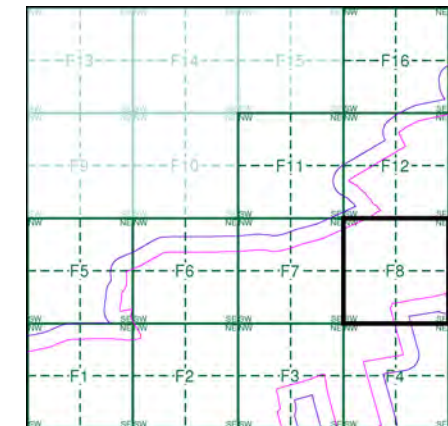

Order Details

Order Number: 297990210_1_1
 Customer Ref: 21-1088.04
 National Grid Reference: 486940, 382710
 Slice: F
 Site Area (Ha): 1120.8
 Search Buffer (m): 100

Site Details

Cottam

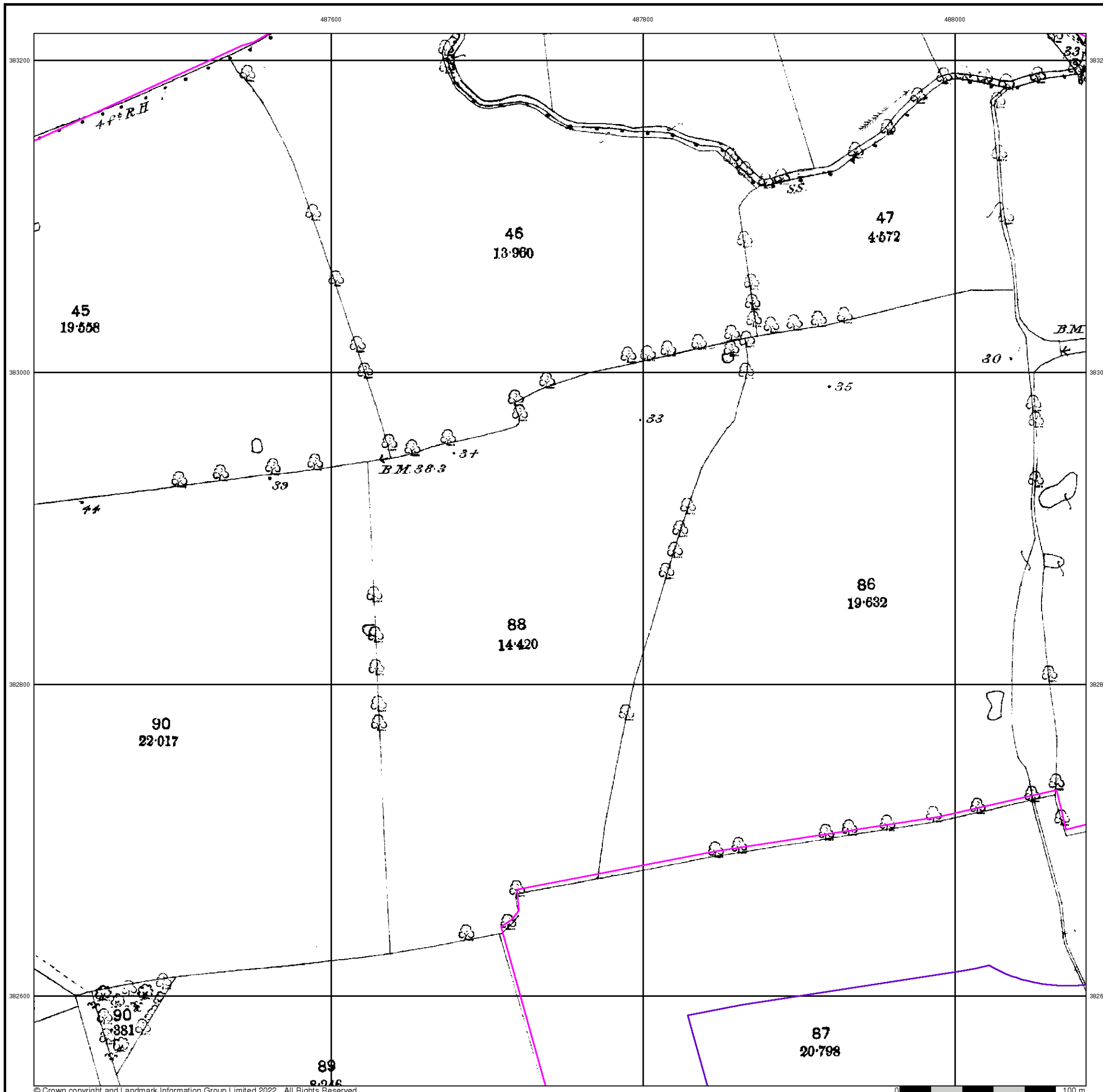

Lincolnshire

Published 1906

Source map scale - 1:2,500

The historical maps shown were reproduced from maps predominantly held at the scale adopted for England, Wales and Scotland in the 1840's. In 1854 the 1:2,500 scale was adopted for mapping urban areas and by 1896 it covered the whole of what were considered to be the cultivated parts of Great Britain. The published date given below is often some years later than the surveyed date. Before 1938, all OS maps were based on the Cassini Projection, with independent surveys of a single county or group of counties, giving rise to significant inaccuracies in outlying areas.

Map Name(s) and Date(s)

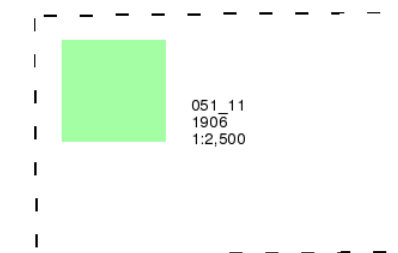

Historical Map - Segment F8

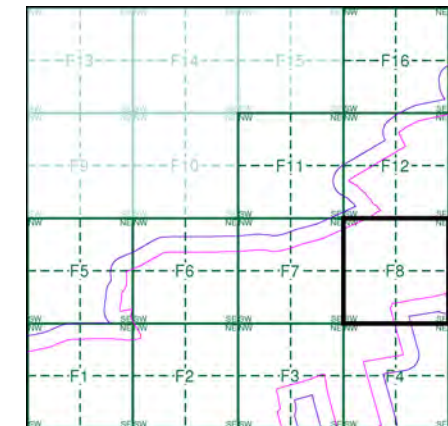

Order Details

Order Number: 297990210_1_1
 Customer Ref: 21-1088.04
 National Grid Reference: 486940, 382710
 Slice: F
 Site Area (Ha): 1120.8
 Search Buffer (m): 100

Site Details

Cottam

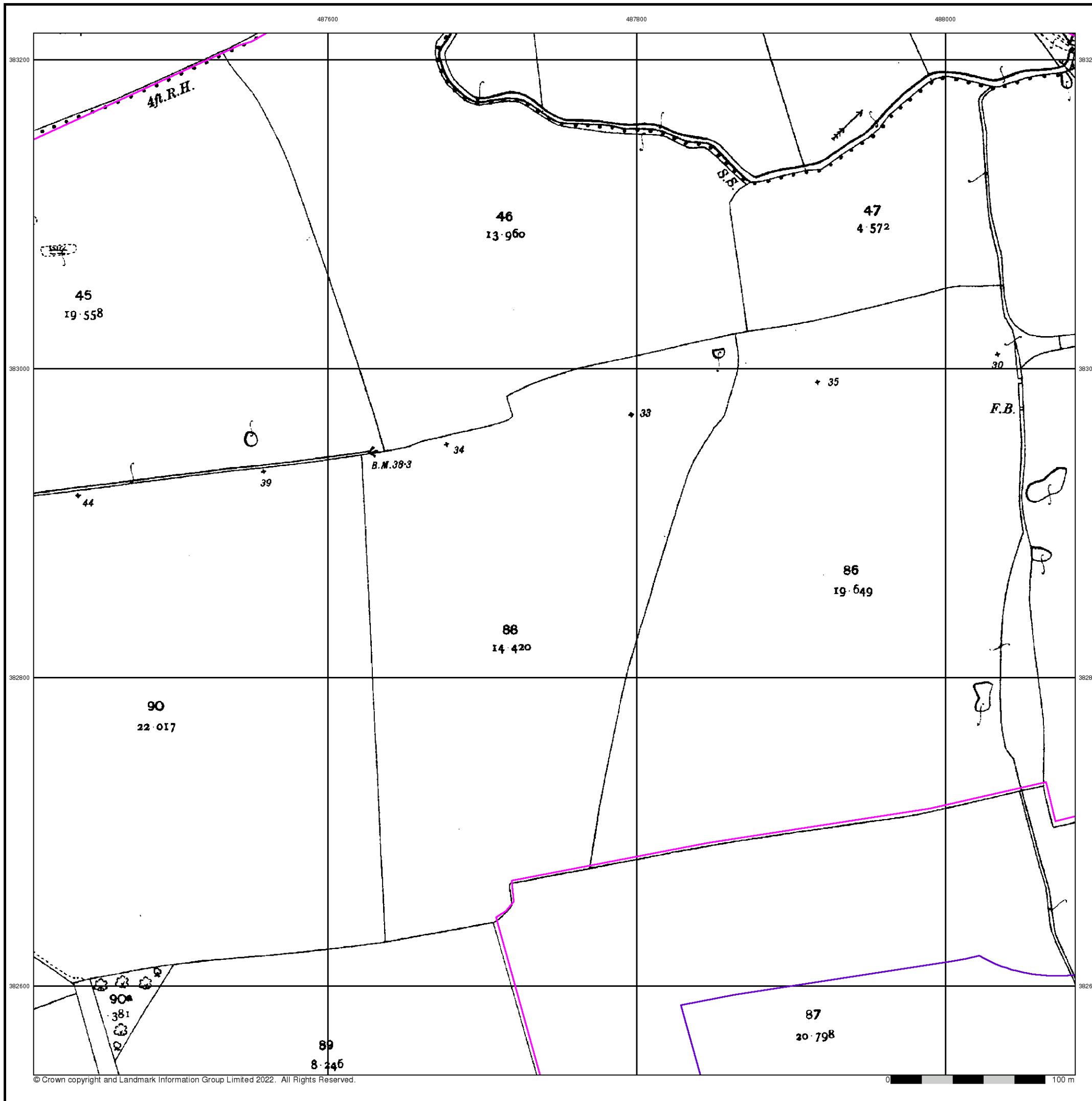

Ordnance Survey Plan

Published 1975

Source map scale - 1:2,500

The historical maps shown were reproduced from maps predominantly held at the scale adopted for England, Wales and Scotland in the 1840's. In 1854 the 1:2,500 scale was adopted for mapping urban areas and by 1896 it covered the whole of what were considered to be the cultivated parts of Great Britain. The published date given below is often some years later than the surveyed date. Before 1938, all OS maps were based on the Cassini Projection, with independent surveys of a single county or group of counties, giving rise to significant inaccuracies in outlying areas.

Map Name(s) and Date(s)

SK8783 1975 12,500	SK8883 1975 12,500
SK8782 1975 12,500	SK8882 1975 12,500

Historical Map - Segment F8

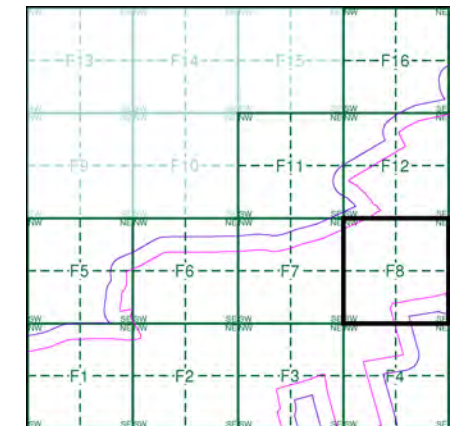

Order Details

Order Number: 297990210_1_1
 Customer Ref: 21-1088.04
 National Grid Reference: 486940, 382710
 Slice: F
 Site Area (Ha): 1120.8
 Search Buffer (m): 100

Site Details

Cottam

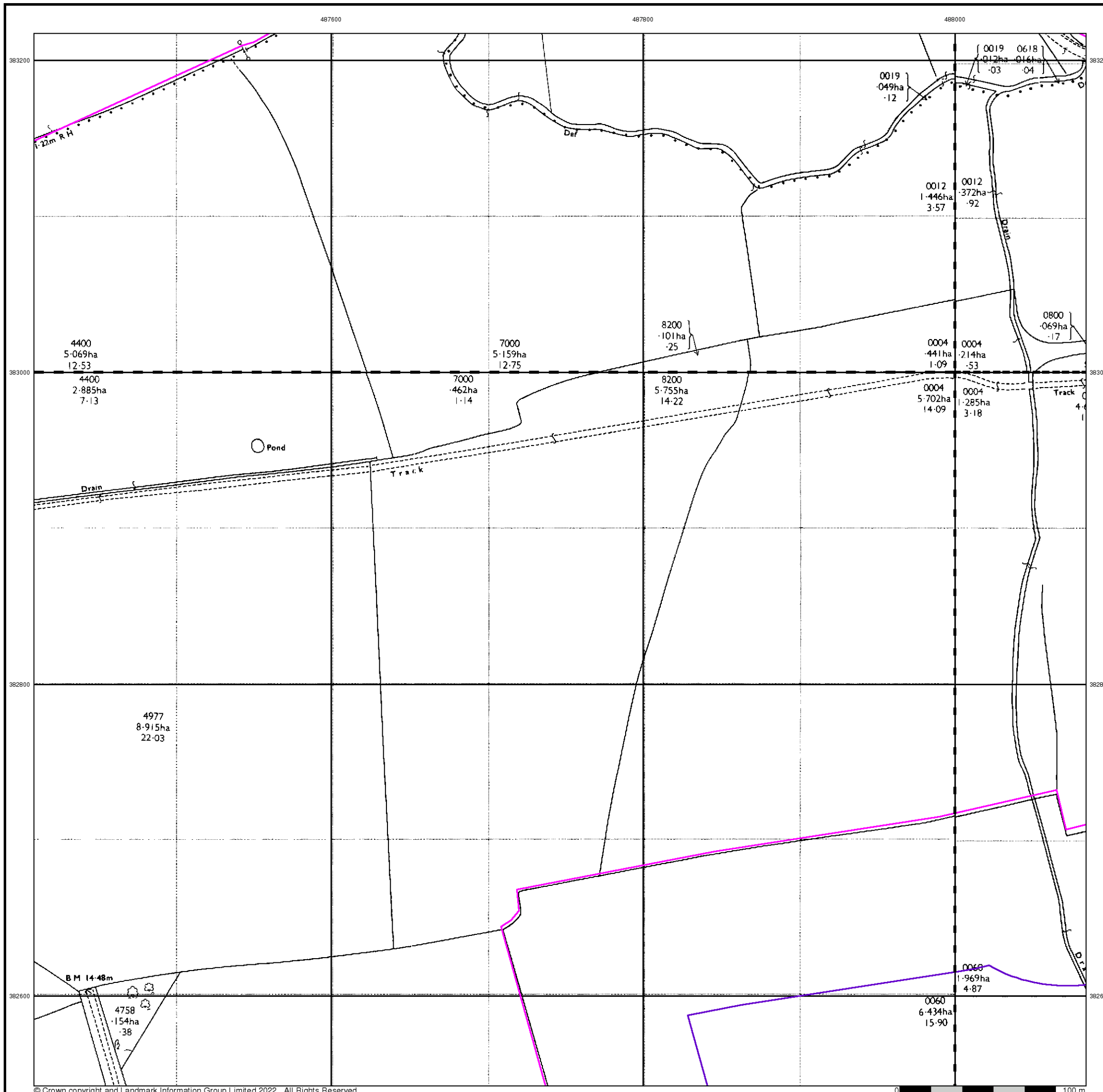

Large-Scale National Grid Data

Published 1994

Source map scale - 1:2,500

'Large Scale National Grid Data' superseded SIM cards (Ordnance Survey's 'Survey of Information on Microfilm') in 1992, and continued to be produced until 1999. These maps were the fore-runners of digital mapping and so provide detailed information on houses and roads, but tend to show less topographic features such as vegetation. These maps were produced at both 1:2,500 and 1:1,250 scales.

Map Name(s) and Date(s)

SK8783 1994 1:2,500	SK8883 1994 1:2,500
SK8782 1994 1:2,500	SK8882 1994 1:2,500

Historical Map - Segment F8

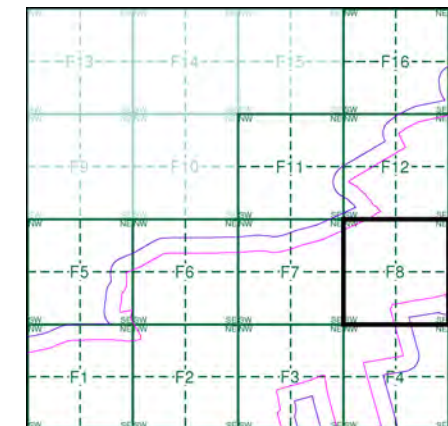

Order Details

Order Number: 297990210_1_1
 Customer Ref: 21-1088.04
 National Grid Reference: 486940, 382710
 Slice: F
 Site Area (Ha): 1120.8
 Search Buffer (m): 100

Site Details

Cottam

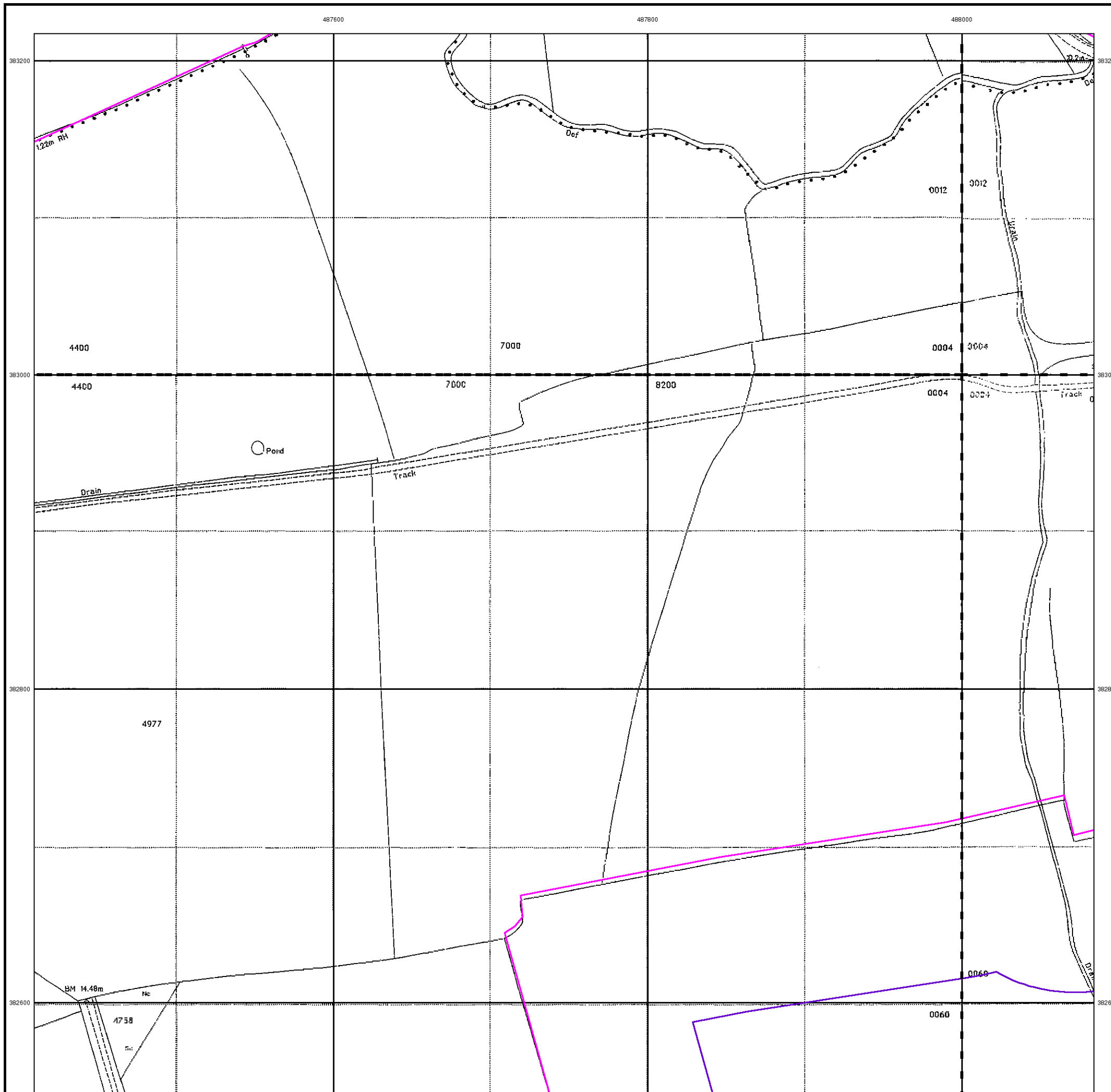

Historical Mapping Legends

Ordnance Survey County Series and Ordnance Survey Plan 1:2,500

Quarry **Gravel Pit** **Sand Pit**
Clay Pit **Shingle** **Refuse Heap**
Sloping Masonry **Flat Rock**
Marsh **Reeds** **Osiers**
Rough Pasture **Furze** **Wood**
Mixed Wood **Brushwood** **Orchard**
Fir **Ford** **Stepping Stones**
Ferry **Waterfall** **Lock**
Trig. Station **Altitude at Trig. Station**
B.M. 325.9 **Bench Mark** **Surface Level**
Arrow denotes flow of water **Antiquities (site of)**
Cutting **Embankment**
Railway crossing Road **Level Crossing** **Road crossing Railway**
Railway crossing River or Canal **Road over single stream** **Road over River or Canal**
County Boundary (Geographical)
County & Civil Parish Boundary
Administrative County & Civil Parish Boundary
County Borough Boundary (England)
Co. Boro. Bdy.
County Burgh Boundary (Scotland)
Boundary Post or Stone **Police Call Box**
B.R. **Bridle Road** **P** **Pump**
E.P. **Electricity Pylon** **S.P.** **Signal Post**
F.B. **Foot Bridge** **Sl.** **Sluice**
F.P. **Foot Path** **Sp.** **Spring**
G.P. **Guide Post or Board** **T.C.B.** **Telephone Call Box**
M.S. **Mile Stone** **Tr.** **Trough**
M.P. M.R. **Mooring Post or Ring** **W** **Well**

Ordnance Survey Plan, Additional SIMs and Supply of Unpublished Survey Information 1:2,500 and 1:1,250

Inactive Quarry, Chalk Pit or Clay Pit **Active Quarry, Chalk Pit or Clay Pit**
Rock **Boulders**
Cliff **Slopes** **Top**
Roofed Building **Glazed Roof Building**
Sloping Masonry **Archway**
Non-Coniferous Tree (surveyed) **Coniferous Tree (surveyed)**
Non-Coniferous Trees (not surveyed) **Coniferous Trees (not surveyed)**
Orchard Tree **Scrub** **Bracken**
Coppice, Osier **Reeds** **Marsh, Saltings**
Rough Grassland **Heath** **Culvert**
Direction of water flow **Bench Mark** **Antiquity (site of)**
Cave Entrance **Triangulation Station** **Electricity Pylon**
Electricity Transmission Line
County Boundary (Geographical)
County & Civil Parish Boundary
Civil Parish Boundary
Admin. County or County Bor. Boundary
London Borough Boundary
Symbol marking point where boundary mereing changes
BH **Beer House** **P** **Pillar, Pole or Post**
BP, BS **Boundary Post or Stone** **PO** **Post Office**
Cn, C **Capstan, Crane** **PC** **Public Convenience**
Chy **Chimney** **PH** **Public House**
D Fn **Drinking Fountain** **Pp** **Pump**
EI P **Electricity Pillar or Post** **SB, S Br** **Signal Box or Bridge**
FAP **Fire Alarm Pillar** **SP, SL** **Signal Post or Light**
FB **Foot Bridge** **Spr** **Spring**
GP **Guide Post** **Tk** **Tank or Track**
H **Hydrant or Hydraulic** **TCB** **Telephone Call Box**
LC **Level Crossing** **TCP** **Telephone Call Post**
MH **Manhole** **Tr** **Trough**
MP **Mile Post or Mooring Post** **Wr Pt, Wr T** **Water Point, Water Tap**
MS **Mile Stone** **W** **Well**
NTL **Normal Tidal Limit** **Wd Pp** **Wind Pump**

Large-Scale National Grid Data 1:2,500 and 1:1,250

Cliff **Slopes** **Top**
Rock **Rock (scattered)**
Boulders **Boulders (scattered)**
Positioned Boulder **Scree**
Non-Coniferous Tree (surveyed) **Coniferous Tree (surveyed)**
Non-Coniferous Trees (not surveyed) **Coniferous Trees (not surveyed)**
Orchard Tree **Scrub** **Bracken**
Coppice, Osier **Reeds** **Marsh, Saltings**
Rough Grassland **Heath** **Culvert**
Direction of water flow **Triangulation Station** **Antiquity (site of)**
Electricity Transmission Line **Electricity Pylon**
B.M. 231.60m **Bench Mark** **Buildings with Building Seed**
Roofed Building **Glazed Roof Building**
Civil parish/community boundary
District boundary
County boundary
Boundary post/stone
Boundary mereing symbol (note: these always appear in opposed pairs or groups of three)
Bks **Barracks** **P** **Pillar, Pole or Post**
Bty **Battery** **PO** **Post Office**
Cemy **Cemetery** **PC** **Public Convenience**
Chy **Chimney** **Pp** **Pump**
Cis **Cistern** **Ppg Sta** **Pumping Station**
Dismtd Rly **Dismantled Railway** **PW** **Place of Worship**
EI Gen Sta **Electricity Generating Station** **Sewage Ppg Sta** **Sewage Pumping Station**
EI P **Electricity Pole, Pillar** **SB, S Br** **Signal Box or Bridge**
EI Sub Sta **Electricity Sub Station** **SP, SL** **Signal Post or Light**
FB **Filter Bed** **Spr** **Spring**
Fn / D Fn **Fountain / Drinking Ftn.** **Tk** **Tank or Track**
Gas Gov **Gas Valve Compound** **Tr** **Trough**
GVC **Gas Governor** **Wd Pp** **Wind Pump**
GP **Guide Post** **Wr Pt, Wr T** **Water Point, Water Tap**
MH **Manhole** **Wks** **Works (building or area)**
MP, MS **Mile Post or Mile Stone** **W** **Well**



Historical Mapping & Photography included:

Mapping Type	Scale	Date	Pg
Lincolnshire	1:2,500	1886	2
Lincolnshire	1:2,500	1906	3
Lincolnshire	1:2,500	1920	4
Ordnance Survey Plan	1:2,500	1975	5
Large-Scale National Grid Data	1:2,500	1994	6

Historical Map - Segment F11

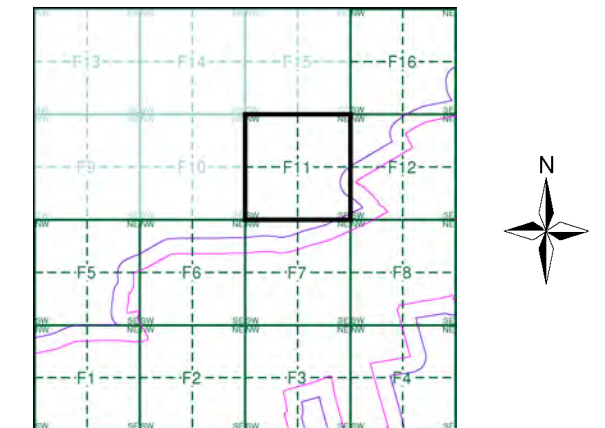

Order Details

Order Number: 297990210_1_1
Customer Ref: 21-1088.04
National Grid Reference: 486940, 382710
Slice: F
Site Area (Ha): 1120.8
Search Buffer (m): 100

Site Details

Cottam



Tel: [Redacted]
Fax: [Redacted]
Web: [Redacted]

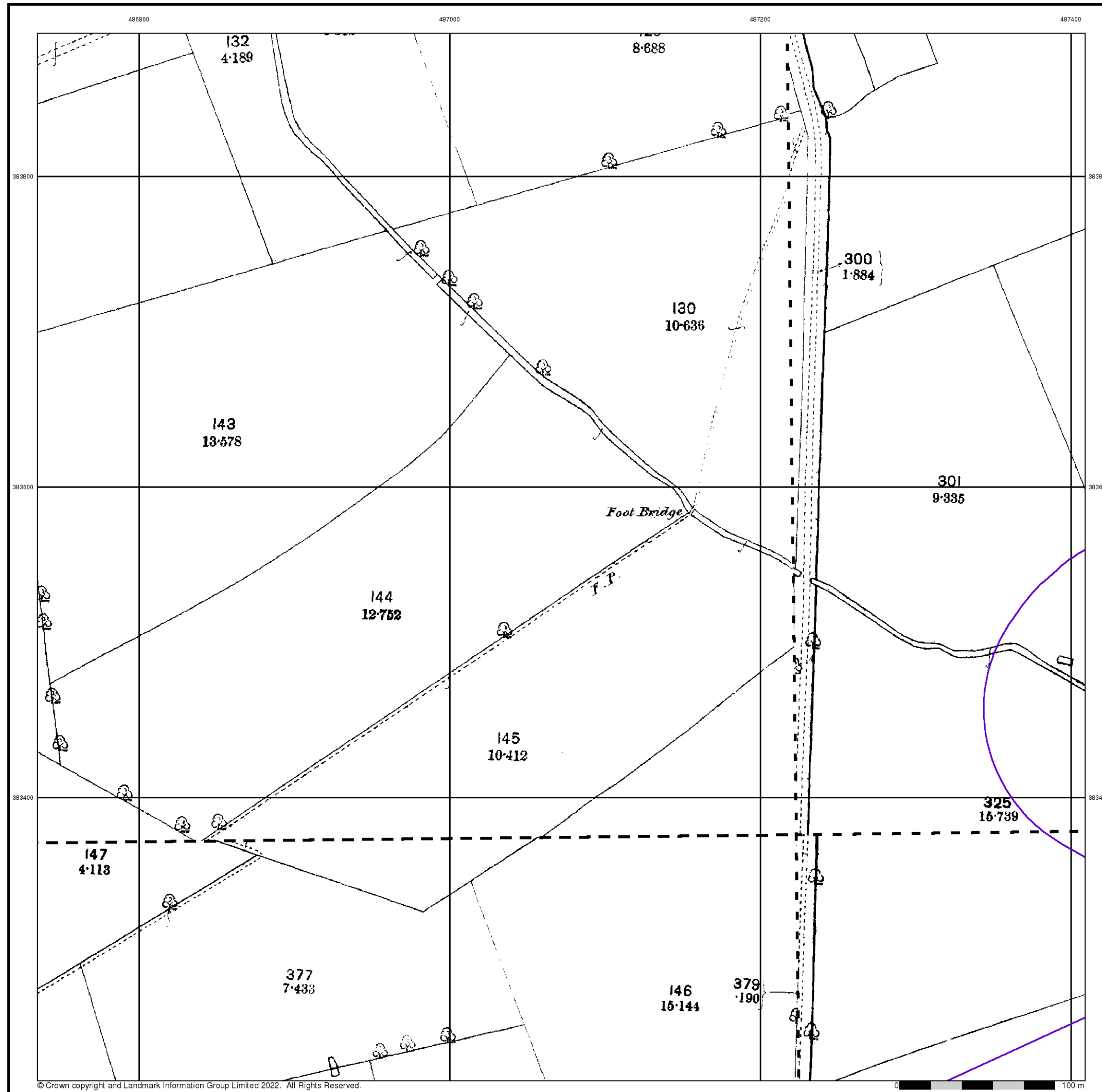

© Crown copyright and Landmark Information Group Limited 2022. All Rights Reserved.



Lincolnshire
Published 1886
Source map scale - 1:2,500

The historical maps shown were reproduced from maps predominantly held at the scale adopted for England, Wales and Scotland in the 1840's. In 1854 the 1:2,500 scale was adopted for mapping urban areas and by 1896 it covered the whole of what were considered to be the cultivated parts of Great Britain. The published date given below is often some years later than the surveyed date. Before 1938, all OS maps were based on the Cassini Projection, with independent surveys of a single county or group of counties, giving rise to significant inaccuracies in outlying areas.

Map Name(s) and Date(s)

051_06 1886 1:2,500	051_07 1886 1:2,500
051_10 1886 1:2,500	051_11 1886 1:2,500

Historical Map - Segment F11

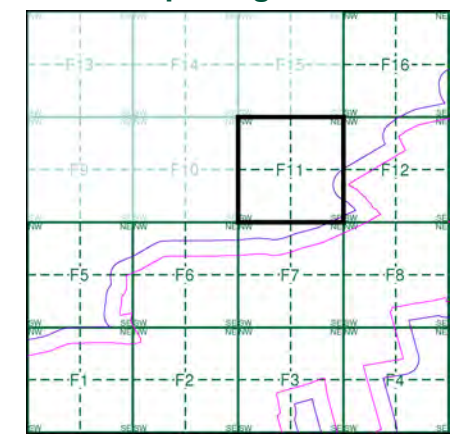

Order Details
 Order Number: 297990210_1_1
 Customer Ref: 21-1088.04
 National Grid Reference: 486940, 382710
 Slice: F
 Site Area (Ha): 1120.8
 Search Buffer (m): 100

Site Details
 Cottam



Tel: [Redacted]
 Fax: [Redacted]
 Web: [Redacted]

Lincolnshire
Published 1906

Source map scale - 1:2,500

The historical maps shown were reproduced from maps predominantly held at the scale adopted for England, Wales and Scotland in the 1840's. In 1854 the 1:2,500 scale was adopted for mapping urban areas and by 1896 it covered the whole of what were considered to be the cultivated parts of Great Britain. The published date given below is often some years later than the surveyed date. Before 1938, all OS maps were based on the Cassini Projection, with independent surveys of a single county or group of counties, giving rise to significant inaccuracies in outlying areas.

Map Name(s) and Date(s)

051_06 1906 1:2,500	051_07 1906 1:2,500
051_10 1906 1:2,500	051_11 1906 1:2,500

Historical Map - Segment F11

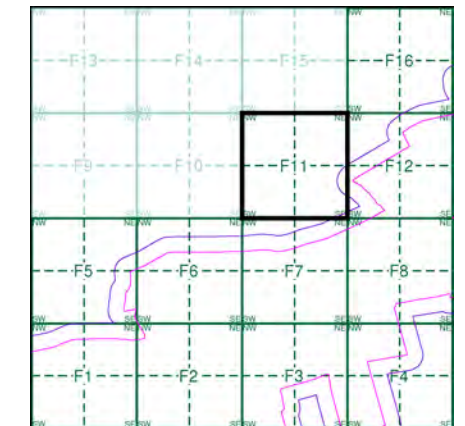

Order Details

Order Number: 297990210_1_1
 Customer Ref: 21-1088.04
 National Grid Reference: 486940, 382710
 Slice: F
 Site Area (Ha): 1120.8
 Search Buffer (m): 100

Site Details

Cottam

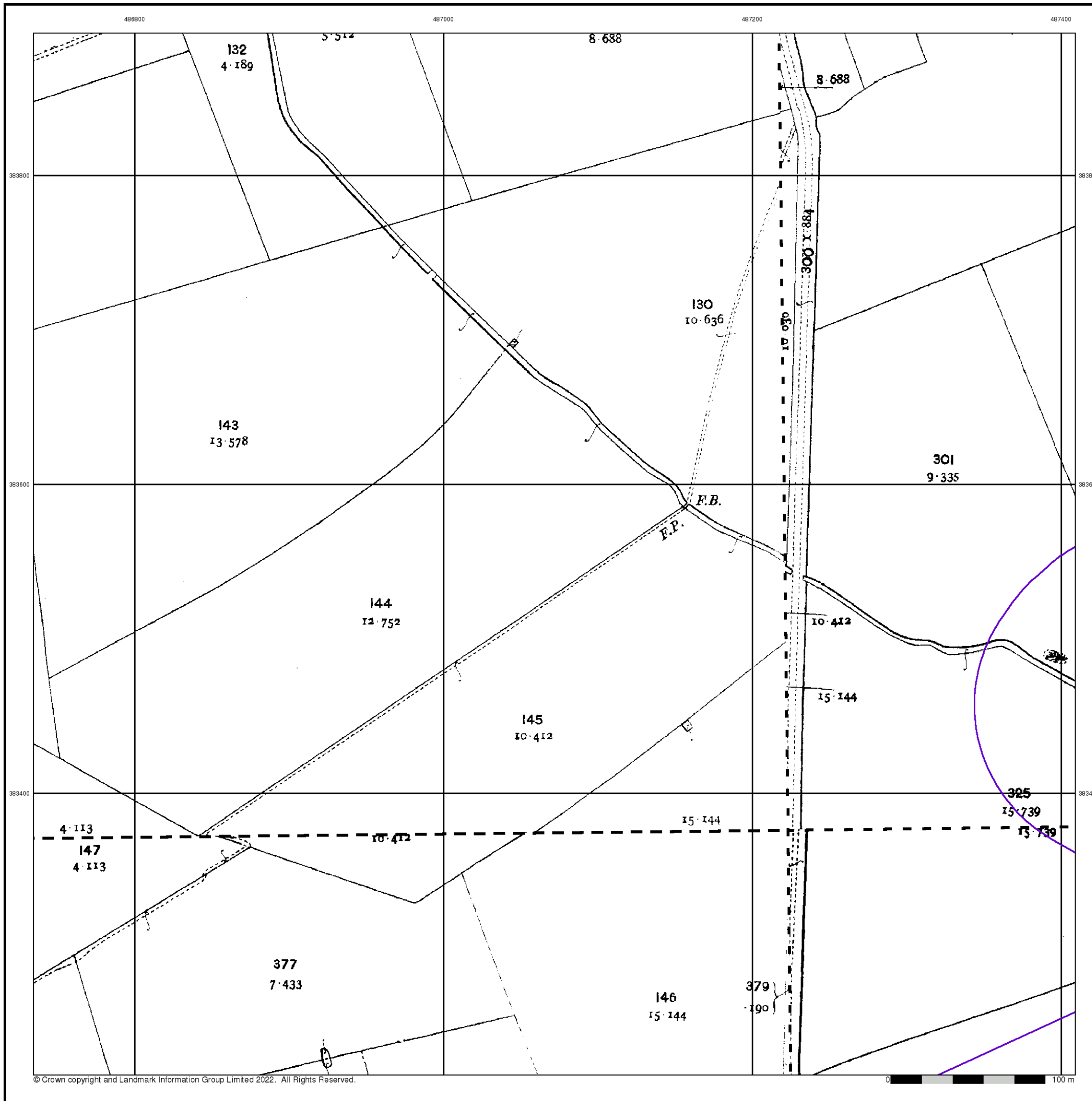

Lincolnshire
Published 1920

Source map scale - 1:2,500

The historical maps shown were reproduced from maps predominantly held at the scale adopted for England, Wales and Scotland in the 1840's. In 1854 the 1:2,500 scale was adopted for mapping urban areas and by 1896 it covered the whole of what were considered to be the cultivated parts of Great Britain. The published date given below is often some years later than the surveyed date. Before 1938, all OS maps were based on the Cassini Projection, with independent surveys of a single county or group of counties, giving rise to significant inaccuracies in outlying areas.

Map Name(s) and Date(s)

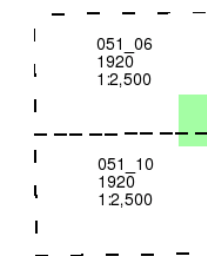

Historical Map - Segment F11

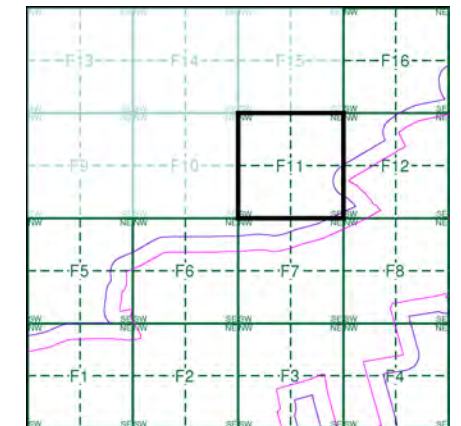

Order Details

Order Number: 297990210_1_1
 Customer Ref: 21-1088.04
 National Grid Reference: 486940, 382710
 Slice: F
 Site Area (Ha): 1120.8
 Search Buffer (m): 100

Site Details

Cottam

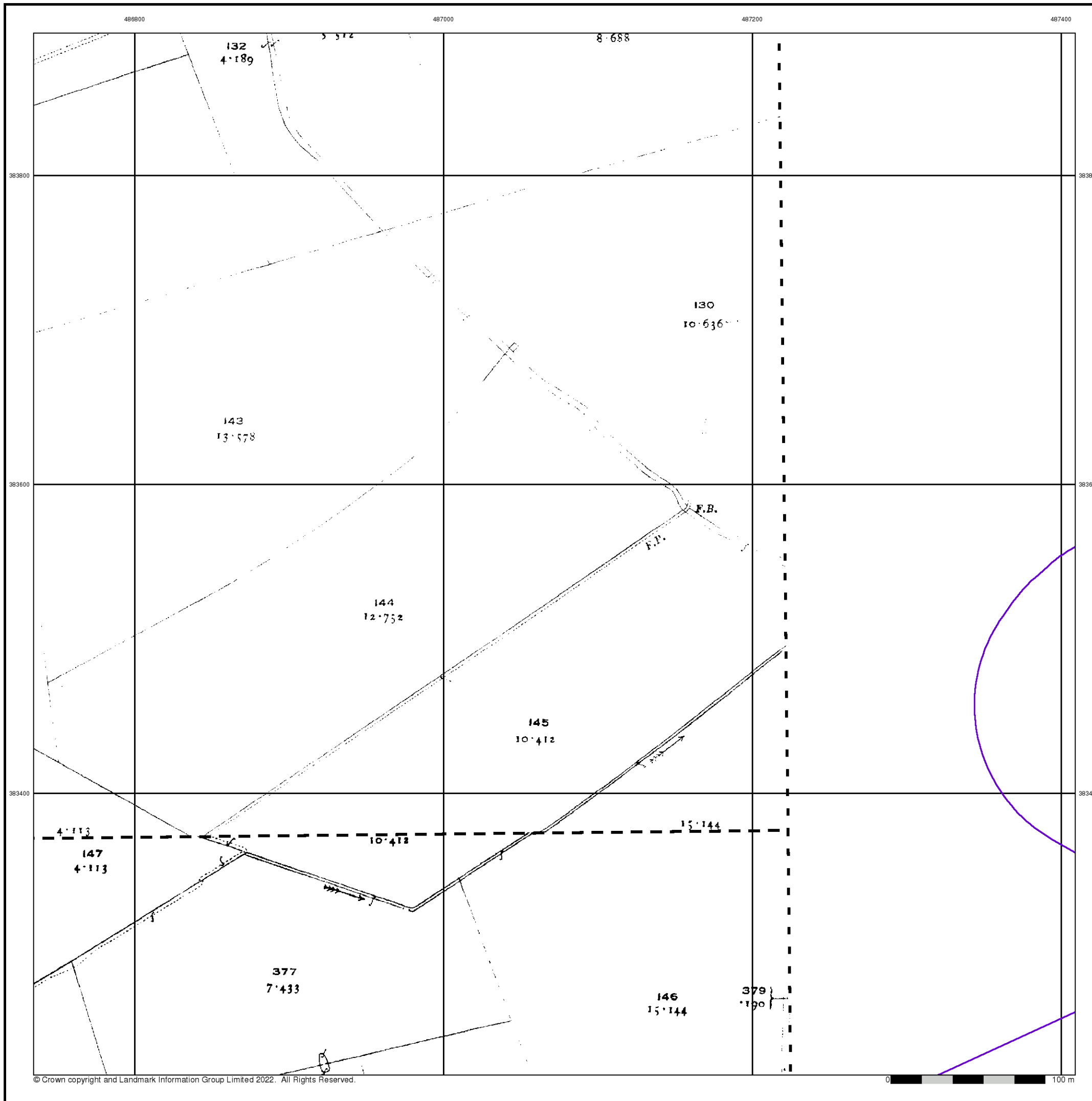

Ordnance Survey Plan

Published 1975

Source map scale - 1:2,500

The historical maps shown were reproduced from maps predominantly held at the scale adopted for England, Wales and Scotland in the 1840's. In 1854 the 1:2,500 scale was adopted for mapping urban areas and by 1896 it covered the whole of what were considered to be the cultivated parts of Great Britain. The published date given below is often some years later than the surveyed date. Before 1938, all OS maps were based on the Cassini Projection, with independent surveys of a single county or group of counties, giving rise to significant inaccuracies in outlying areas.

Map Name(s) and Date(s)

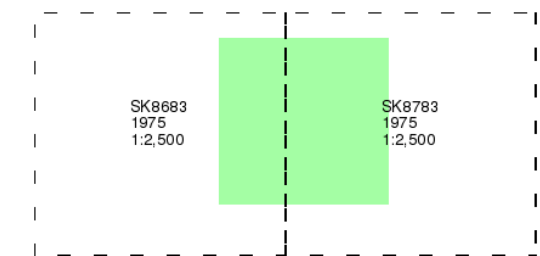

Historical Map - Segment F11

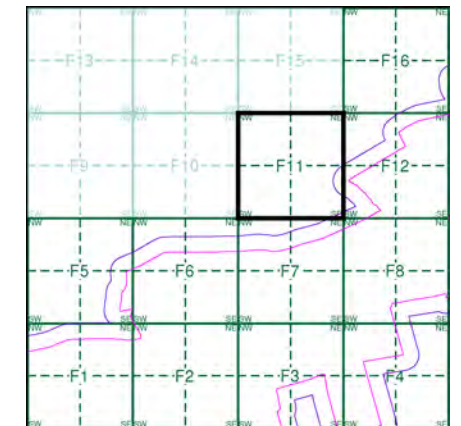

Order Details

Order Number: 297990210_1_1
 Customer Ref: 21-1088.04
 National Grid Reference: 486940, 382710
 Slice: F
 Site Area (Ha): 1120.8
 Search Buffer (m): 100

Site Details

Cottam

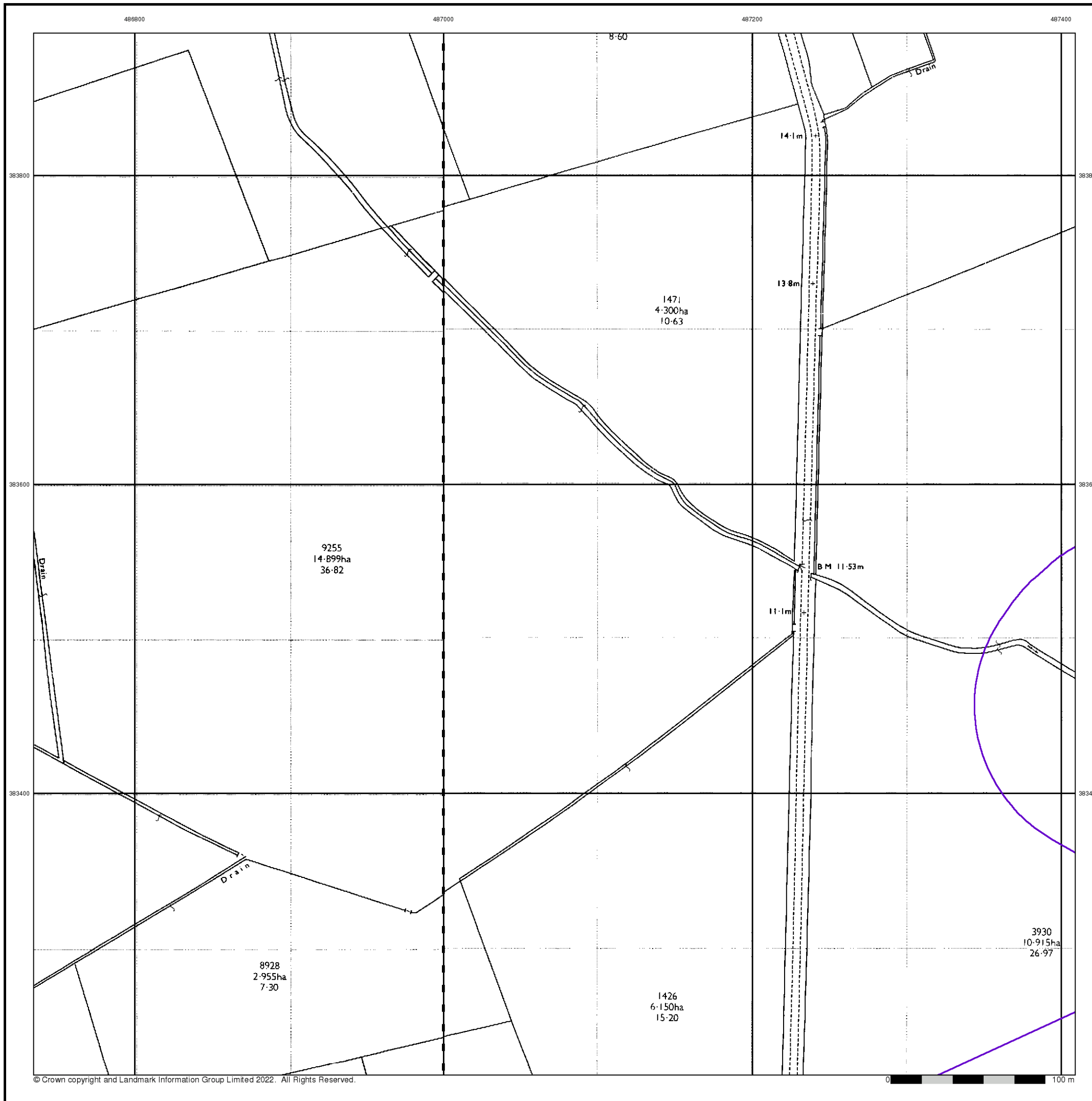

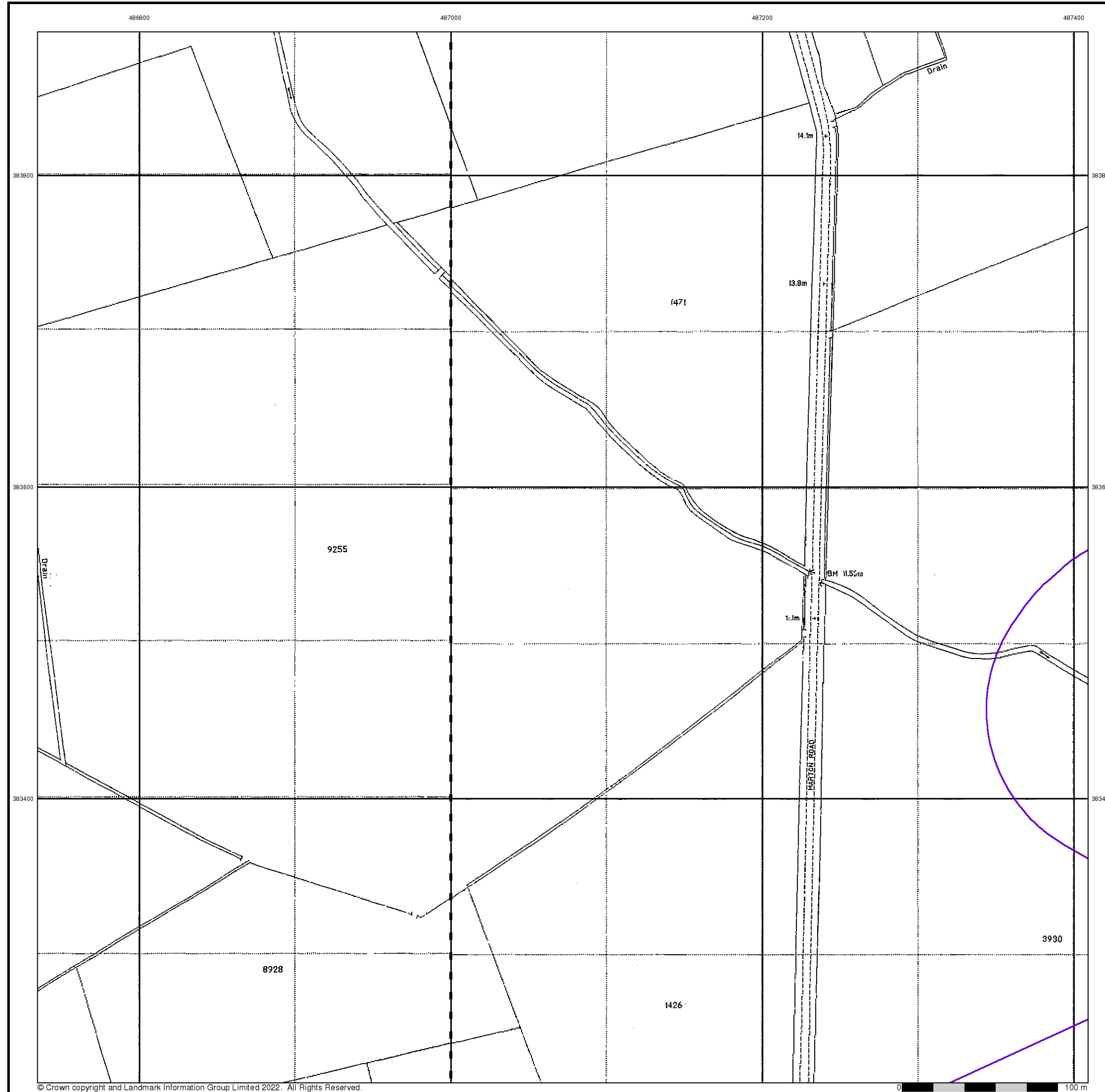

© Crown copyright and Landmark Information Group Limited 2022. All Rights Reserved.



Large-Scale National Grid Data
Published 1994
Source map scale - 1:2,500

'Large Scale National Grid Data' superseded SIM cards (Ordnance Survey's 'Survey of Information on Microfilm') in 1992, and continued to be produced until 1999. These maps were the fore-runners of digital mapping and so provide detailed information on houses and roads, but tend to show less topographic features such as vegetation. These maps were produced at both 1:2,500 and 1:1,250 scales.

Map Name(s) and Date(s)

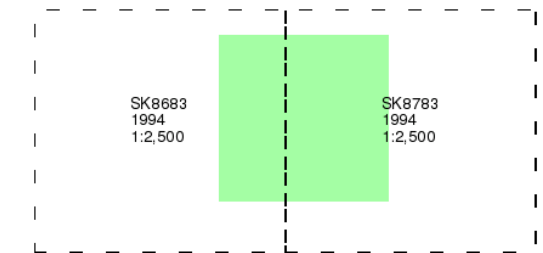

Historical Map - Segment F11

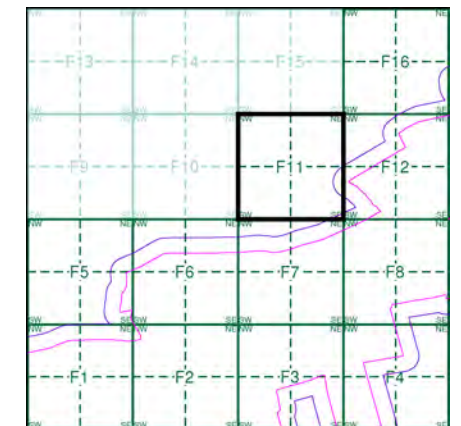

Order Details

Order Number: 297990210_1_1
 Customer Ref: 21-1088.04
 National Grid Reference: 486940, 382710
 Slice: F
 Site Area (Ha): 1120.8
 Search Buffer (m): 100

Site Details

Cottam



Tel: [Redacted]
 Fax: [Redacted]
 Web: [Redacted]

Historical Mapping Legends

Ordnance Survey County Series and Ordnance Survey Plan 1:2,500

Quarry **Gravel Pit** **Sand Pit**
Clay Pit **Shingle** **Refuse Heap**
Sloping Masonry **Flat Rock**
Marsh **Reeds** **Osiers**
Rough Pasture **Furze** **Wood**
Mixed Wood **Brushwood** **Orchard**
Fir **Ford** **Stepping Stones**
Ferry **Waterfall** **Lock**
Trig. Station **Altitude at Trig. Station**
B.M. 325.9 **Bench Mark** **Surface Level**
Arrow denotes flow of water **Antiquities (site of)**
Cutting **Embankment**
Railway crossing Road **Level Crossing** **Road crossing Railway**
Railway crossing River or Canal **Road over single stream** **Road over River or Canal**
County Boundary (Geographical)
County & Civil Parish Boundary
Administrative County & Civil Parish Boundary
County Borough Boundary (England)
Co. Boro. Bdy.
County Burgh Boundary (Scotland)
Co. Burgh Bdy.
BP BS Boundary Post or Stone **P.C.B** Police Call Box
B.R. Bridle Road **P** Pump
E.P Electricity Pylon **S.P** Signal Post
F.B. Foot Bridge **SL** Sluice
F.P. Foot Path **Sp.** Spring
G.P Guide Post or Board **T.C.B** Telephone Call Box
M.S Mile Stone **Tr.** Trough
M.P M.R Mooring Post or Ring **W** Well

Ordnance Survey Plan, Additional SIMs and Supply of Unpublished Survey Information 1:2,500 and 1:1,250

Inactive Quarry, Chalk Pit or Clay Pit **Active Quarry, Chalk Pit or Clay Pit**
Rock **Boulders**
Cliff **Slopes** **Top**
Roofed Building **Glazed Roof Building**
Sloping Masonry **Archway**
Non-Coniferous Tree (surveyed) **Coniferous Tree (surveyed)**
Non-Coniferous Trees (not surveyed) **Coniferous Trees (not surveyed)**
Orchard Tree **Scrub** **Bracken**
Coppice, Osier **Reeds** **Marsh, Saltings**
Rough Grassland **Heath** **Culvert**
Direction of water flow **Bench Mark** **Antiquity (site of)**
Cave Entrance **Triangulation Station** **Electricity Pylon**
Electricity Transmission Line
County Boundary (Geographical)
County & Civil Parish Boundary
Civil Parish Boundary
Admin. County or County Bor. Boundary
London Borough Boundary
Symbol marking point where boundary mereing changes
BH Beer House **P** Pillar, Pole or Post
BP, BS Boundary Post or Stone **PO** Post Office
Cn, C Capstan, Crane **PC** Public Convenience
Chy Chimney **PH** Public House
D Fn Drinking Fountain **Pp** Pump
EI P Electricity Pillar or Post **SB, S Br** Signal Box or Bridge
FAP Fire Alarm Pillar **SP, SL** Signal Post or Light
FB Foot Bridge **Spr** Spring
GP Guide Post **Tk** Tank or Track
H Hydrant or Hydraulic **TCB** Telephone Call Box
LC Level Crossing **TCP** Telephone Call Post
MH Manhole **Tr** Trough
MP Mile Post or Mooring Post **Wr Pt, Wr T** Water Point, Water Tap
MS Mile Stone **W** Well
NTL Normal Tidal Limit **Wd Pp** Wind Pump

Large-Scale National Grid Data 1:2,500 and 1:1,250

Cliff **Slopes** **Top**
Rock **Rock (scattered)**
Boulders **Boulders (scattered)**
Positioned Boulder **Scree**
Non-Coniferous Tree (surveyed) **Coniferous Tree (surveyed)**
Non-Coniferous Trees (not surveyed) **Coniferous Trees (not surveyed)**
Orchard Tree **Scrub** **Bracken**
Coppice, Osier **Reeds** **Marsh, Saltings**
Rough Grassland **Heath** **Culvert**
Direction of water flow **Triangulation Station** **Antiquity (site of)**
Electricity Transmission Line **Electricity Pylon**
BM 231.60m Bench Mark **Buildings with Building Seed**
Roofed Building **Glazed Roof Building**
Civil parish/community boundary
District boundary
County boundary
Boundary post/stone
Boundary mereing symbol (note: these always appear in opposed pairs or groups of three)
Bks Barracks **P** Pillar, Pole or Post
Bty Battery **PO** Post Office
Cemy Cemetery **PC** Public Convenience
Chy Chimney **Pp** Pump
Cis Cistern **Ppg Sta** Pumping Station
Dismtd Rly Dismantled Railway **PW** Place of Worship
EI Gen Sta Electricity Generating Station **Sewage Ppg Sta** Sewage Pumping Station
EI P Electricity Pole, Pillar **SB, S Br** Signal Box or Bridge
EI Sub Sta Electricity Sub Station **SP, SL** Signal Post or Light
FB Filter Bed **Spr** Spring
Fn / D Fn Fountain / Drinking Ftn. **Tk** Tank or Track
Gas Gov Gas Valve Compound **Tr** Trough
GVC Gas Governor **Wd Pp** Wind Pump
GP Guide Post **Wr Pt, Wr T** Water Point, Water Tap
MH Manhole **Wks** Works (building or area)
MP, MS Mile Post or Mile Stone **W** Well



Historical Mapping & Photography included:

Mapping Type	Scale	Date	Pg
Lincolnshire	1:2,500	1886	2
Lincolnshire	1:2,500	1906	3
Ordnance Survey Plan	1:2,500	1975	4
Large-Scale National Grid Data	1:2,500	1994	5

Historical Map - Segment F12

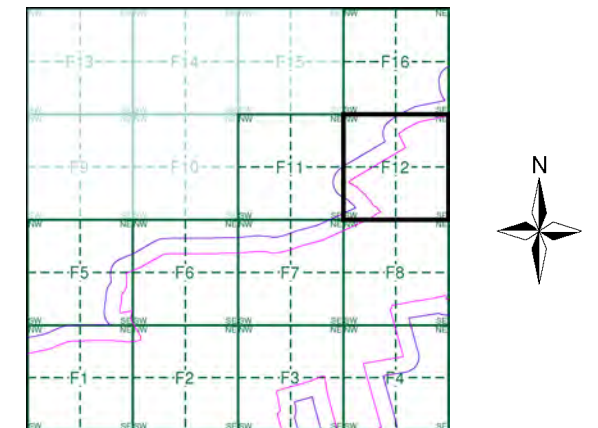

Order Details

Order Number: 297990210_1_1
 Customer Ref: 21-1088.04
 National Grid Reference: 486940, 382710
 Slice: F
 Site Area (Ha): 1120.8
 Search Buffer (m): 100

Site Details

Cottam



Tel: [Redacted]
 Fax: [Redacted]
 Web: [Redacted]

Lincolnshire
Published 1886

Source map scale - 1:2,500

The historical maps shown were reproduced from maps predominantly held at the scale adopted for England, Wales and Scotland in the 1840's. In 1854 the 1:2,500 scale was adopted for mapping urban areas and by 1896 it covered the whole of what were considered to be the cultivated parts of Great Britain. The published date given below is often some years later than the surveyed date. Before 1938, all OS maps were based on the Cassini Projection, with independent surveys of a single county or group of counties, giving rise to significant inaccuracies in outlying areas.

Map Name(s) and Date(s)

051_07	1886	1:2,500
051_11	1886	1:2,500

Historical Map - Segment F12

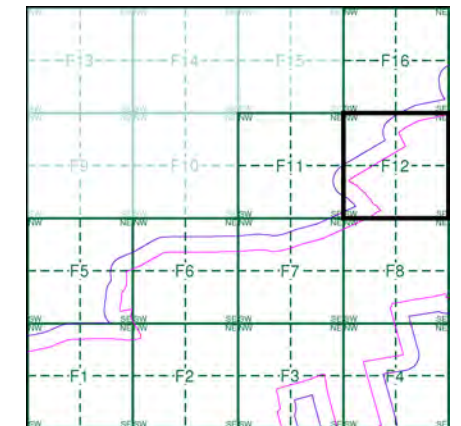

Order Details

Order Number: 297990210_1_1
 Customer Ref: 21-1088.04
 National Grid Reference: 486940, 382710
 Slice: F
 Site Area (Ha): 1120.8
 Search Buffer (m): 100

Site Details

Cottam

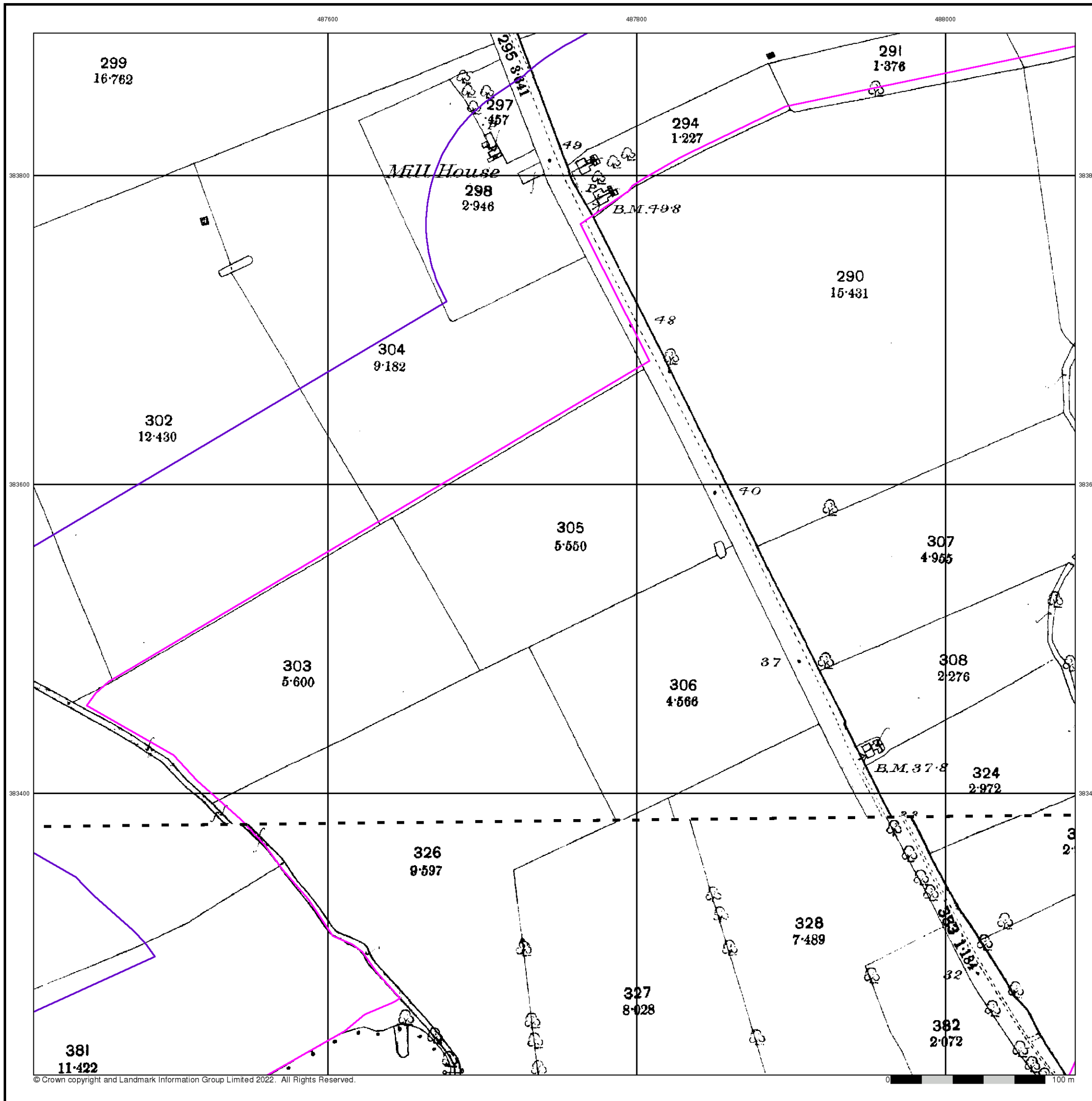

Lincolnshire
Published 1906

Source map scale - 1:2,500

The historical maps shown were reproduced from maps predominantly held at the scale adopted for England, Wales and Scotland in the 1840's. In 1854 the 1:2,500 scale was adopted for mapping urban areas and by 1896 it covered the whole of what were considered to be the cultivated parts of Great Britain. The published date given below is often some years later than the surveyed date. Before 1938, all OS maps were based on the Cassini Projection, with independent surveys of a single county or group of counties, giving rise to significant inaccuracies in outlying areas.

Map Name(s) and Date(s)

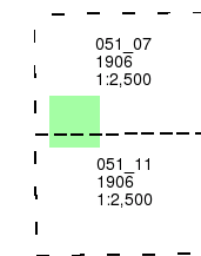

Historical Map - Segment F12

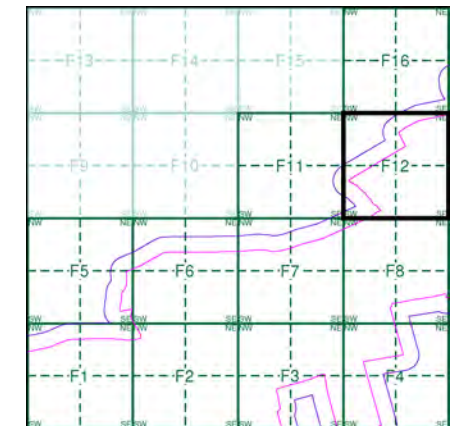

Order Details

Order Number: 297990210_1_1
 Customer Ref: 21-1088.04
 National Grid Reference: 486940, 382710
 Slice: F
 Site Area (Ha): 1120.8
 Search Buffer (m): 100

Site Details

Cottam

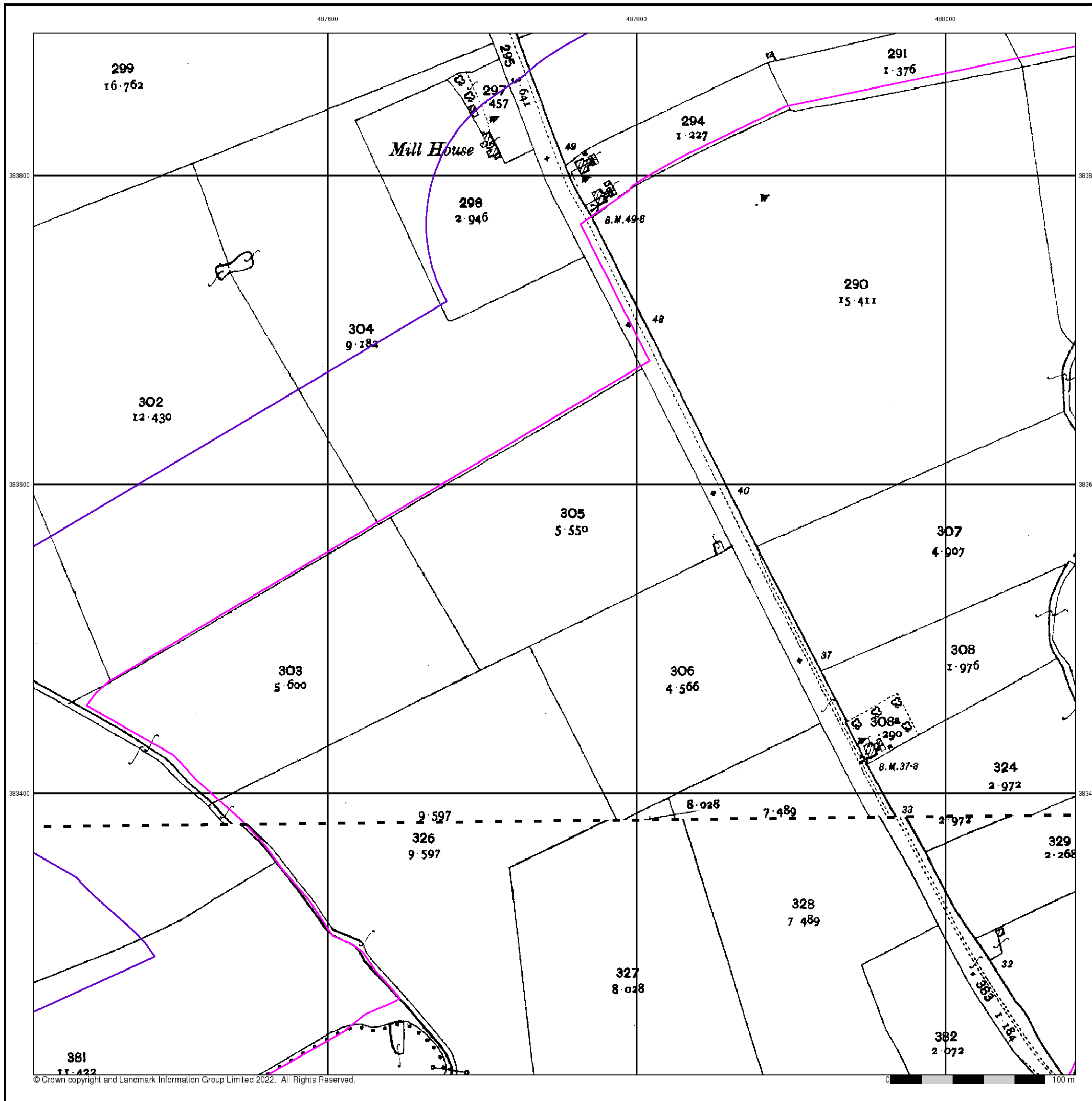

Ordnance Survey Plan

Published 1975

Source map scale - 1:2,500

The historical maps shown were reproduced from maps predominantly held at the scale adopted for England, Wales and Scotland in the 1840's. In 1854 the 1:2,500 scale was adopted for mapping urban areas and by 1896 it covered the whole of what were considered to be the cultivated parts of Great Britain. The published date given below is often some years later than the surveyed date. Before 1938, all OS maps were based on the Cassini Projection, with independent surveys of a single county or group of counties, giving rise to significant inaccuracies in outlying areas.

Map Name(s) and Date(s)

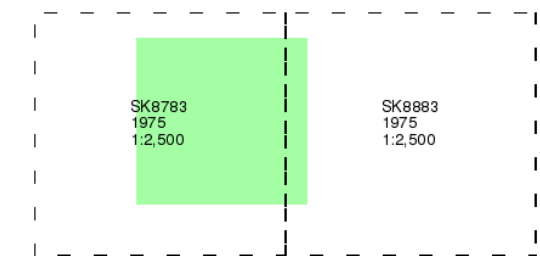

Historical Map - Segment F12

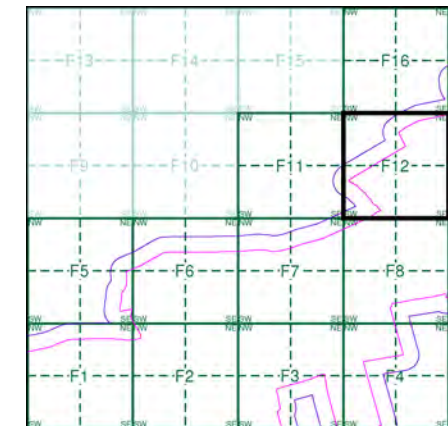

Order Details

Order Number: 297990210_1_1
 Customer Ref: 21-1088.04
 National Grid Reference: 486940, 382710
 Slice: F
 Site Area (Ha): 1120.8
 Search Buffer (m): 100

Site Details

Cottam

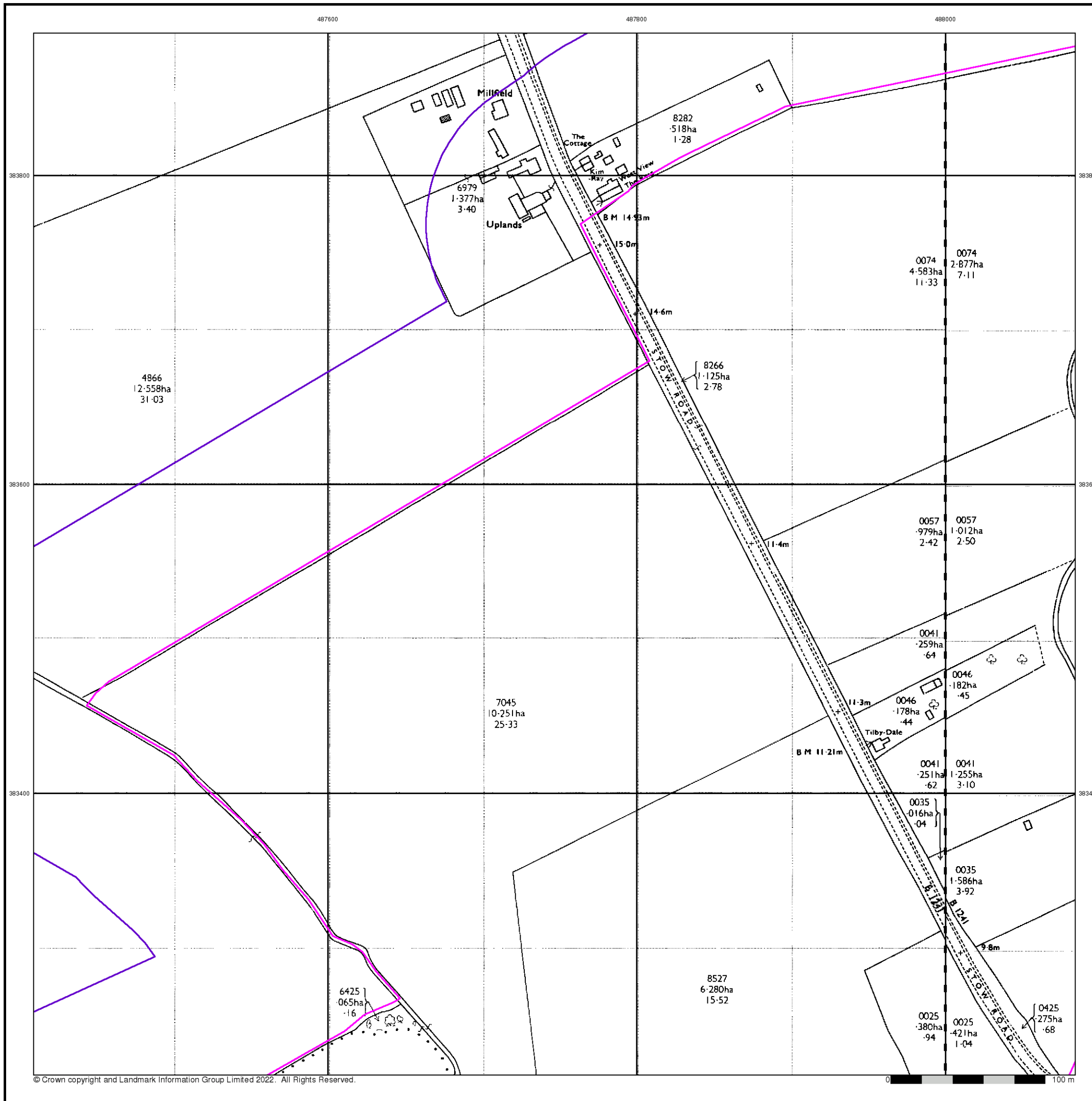

Large-Scale National Grid Data

Published 1994

Source map scale - 1:2,500

'Large Scale National Grid Data' superseded SIM cards (Ordnance Survey's 'Survey of Information on Microfilm') in 1992, and continued to be produced until 1999. These maps were the fore-runners of digital mapping and so provide detailed information on houses and roads, but tend to show less topographic features such as vegetation. These maps were produced at both 1:2,500 and 1:1,250 scales.

Map Name(s) and Date(s)

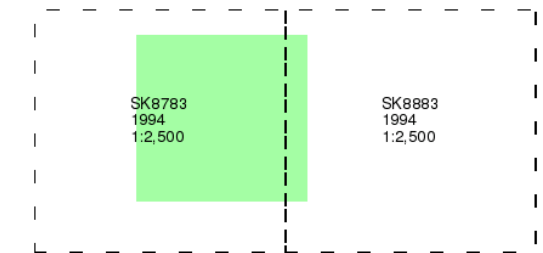

Historical Map - Segment F12

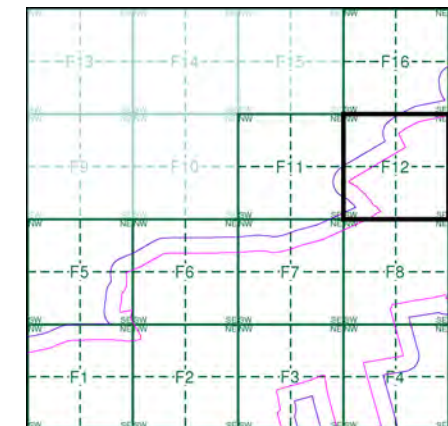

Order Details

Order Number: 297990210_1_1
 Customer Ref: 21-1088.04
 National Grid Reference: 486940, 382710
 Slice: F
 Site Area (Ha): 1120.8
 Search Buffer (m): 100

Site Details

Cottam

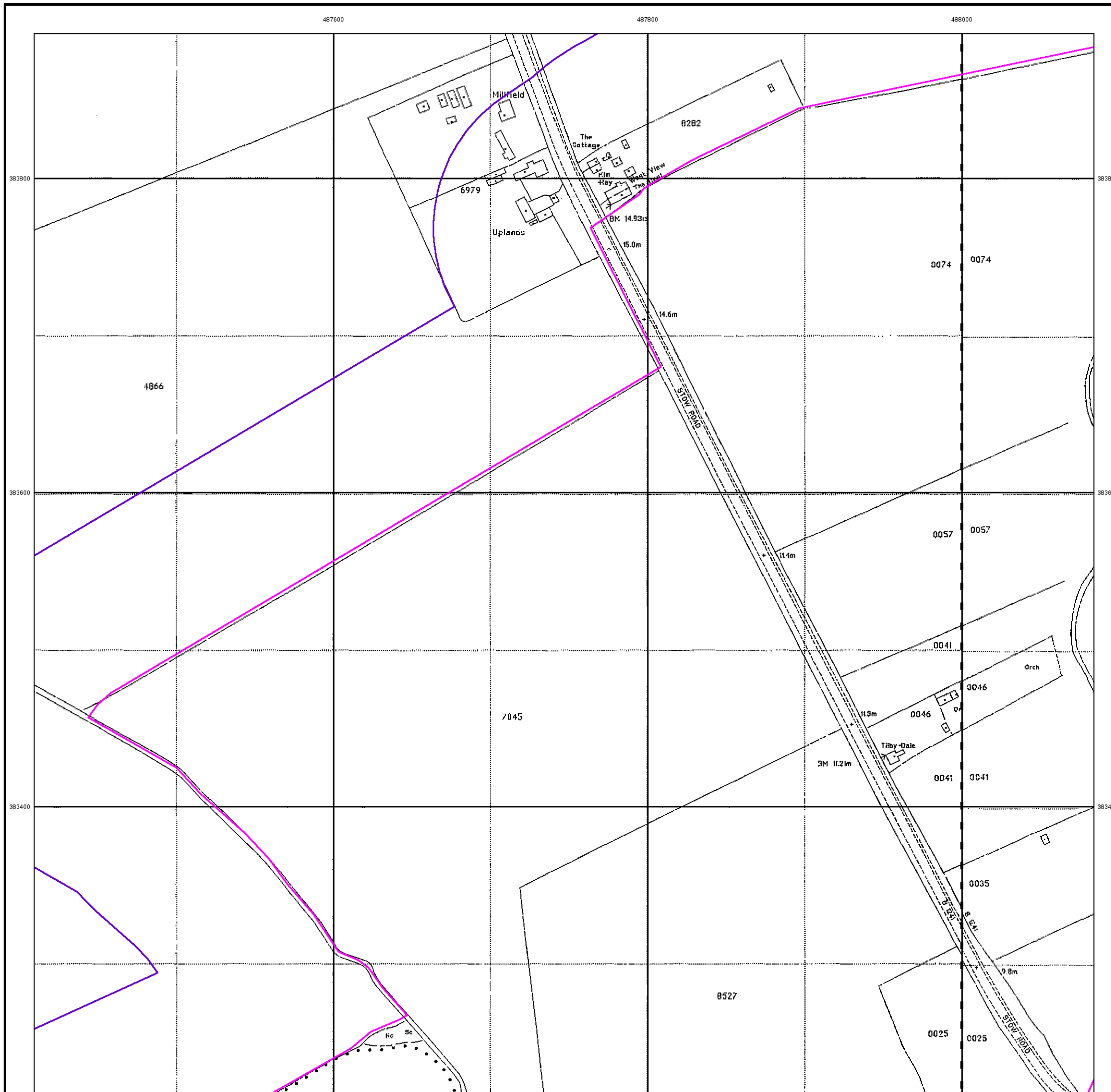

Historical Mapping Legends

Ordnance Survey County Series and Ordnance Survey Plan 1:2,500

Quarry **Gravel Pit** **Sand Pit**
Clay Pit **Shingle** **Refuse Heap**
Sloping Masonry **Flat Rock**
Marsh **Reeds** **Osiers**
Rough Pasture **Furze** **Wood**
Mixed Wood **Brushwood** **Orchard**
Fir **Ford** **Stepping Stones**
Ferry **Waterfall** **Lock**
Trig. Station **Altitude at Trig. Station**
B.M. 325.9 **Bench Mark** **Surface Level**
Arrow denotes flow of water **Antiquities (site of)**
Cutting **Embankment**
Railway crossing Road **Level Crossing** **Road crossing Railway**
Railway crossing River or Canal **Road over single stream** **Road over River or Canal**
County Boundary (Geographical)
County & Civil Parish Boundary
Administrative County & Civil Parish Boundary
County Borough Boundary (England)
Co. Boro. Bdy.
County Burgh Boundary (Scotland)
Boundary Post or Stone **Police Call Box**
B.R. **Bridle Road** **P** **Pump**
E.P. **Electricity Pylon** **S.P.** **Signal Post**
F.B. **Foot Bridge** **Sl.** **Sluice**
F.P. **Foot Path** **Sp.** **Spring**
G.P. **Guide Post or Board** **T.C.B.** **Telephone Call Box**
M.S. **Mile Stone** **Tr.** **Trough**
M.P. M.R. **Mooring Post or Ring** **W** **Well**

Ordnance Survey Plan, Additional SIMs and Supply of Unpublished Survey Information 1:2,500 and 1:1,250

Inactive Quarry, Chalk Pit or Clay Pit **Active Quarry, Chalk Pit or Clay Pit**
Rock **Boulders**
Cliff **Slopes** **Top**
Roofed Building **Glazed Roof Building**
Sloping Masonry **Archway**
Non-Coniferous Tree (surveyed) **Coniferous Tree (surveyed)**
Non-Coniferous Trees (not surveyed) **Coniferous Trees (not surveyed)**
Orchard Tree **Scrub** **Bracken**
Coppice, Osier **Reeds** **Marsh, Saltings**
Rough Grassland **Heath** **Culvert**
Direction of water flow **Bench Mark** **Antiquity (site of)**
Cave Entrance **Triangulation Station** **Electricity Pylon**
Electricity Transmission Line
County Boundary (Geographical)
County & Civil Parish Boundary
Civil Parish Boundary
Admin. County or County Bor. Boundary
London Borough Boundary
Symbol marking point where boundary mereing changes
BH **Beer House** **P** **Pillar, Pole or Post**
BP, BS **Boundary Post or Stone** **PO** **Post Office**
Cn, C **Capstan, Crane** **PC** **Public Convenience**
Chy **Chimney** **PH** **Public House**
D Fn **Drinking Fountain** **Pp** **Pump**
EI P **Electricity Pillar or Post** **SB, S Br** **Signal Box or Bridge**
FAP **Fire Alarm Pillar** **SP, SL** **Signal Post or Light**
FB **Foot Bridge** **Spr** **Spring**
GP **Guide Post** **Tk** **Tank or Track**
H **Hydrant or Hydraulic** **TCB** **Telephone Call Box**
LC **Level Crossing** **TCP** **Telephone Call Post**
MH **Manhole** **Tr** **Trough**
MP **Mile Post or Mooring Post** **Wr Pt, Wr T** **Water Point, Water Tap**
MS **Mile Stone** **W** **Well**
NTL **Normal Tidal Limit** **Wd Pp** **Wind Pump**

Large-Scale National Grid Data 1:2,500 and 1:1,250

Cliff **Slopes** **Top**
Rock **Rock (scattered)**
Boulders **Boulders (scattered)**
Positioned Boulder **Scree**
Non-Coniferous Tree (surveyed) **Coniferous Tree (surveyed)**
Non-Coniferous Trees (not surveyed) **Coniferous Trees (not surveyed)**
Orchard Tree **Scrub** **Bracken**
Coppice, Osier **Reeds** **Marsh, Saltings**
Rough Grassland **Heath** **Culvert**
Direction of water flow **Triangulation Station** **Antiquity (site of)**
Electricity Transmission Line **Electricity Pylon**
B.M. 231.60m **Bench Mark** **Buildings with Building Seed**
Roofed Building **Glazed Roof Building**
Civil parish/community boundary
District boundary
County boundary
Boundary post/stone
Boundary mereing symbol (note: these always appear in opposed pairs or groups of three)
Bks **Barracks** **P** **Pillar, Pole or Post**
Bty **Battery** **PO** **Post Office**
Cemy **Cemetery** **PC** **Public Convenience**
Chy **Chimney** **Pp** **Pump**
Cis **Cistern** **Ppg Sta** **Pumping Station**
Dismtd Rly **Dismantled Railway** **PW** **Place of Worship**
EI Gen Sta **Electricity Generating Station** **Sewage Ppg Sta** **Sewage Pumping Station**
EI P **Electricity Pole, Pillar** **SB, S Br** **Signal Box or Bridge**
EI Sub Sta **Electricity Sub Station** **SP, SL** **Signal Post or Light**
FB **Filter Bed** **Spr** **Spring**
Fn / D Fn **Fountain / Drinking Ftn.** **Tk** **Tank or Track**
Gas Gov **Gas Valve Compound** **Tr** **Trough**
GVC **Gas Governor** **Wd Pp** **Wind Pump**
GP **Guide Post** **Wr Pt, Wr T** **Water Point, Water Tap**
MH **Manhole** **Wks** **Works (building or area)**
MP, MS **Mile Post or Mile Stone** **W** **Well**



Historical Mapping & Photography included:

Mapping Type	Scale	Date	Pg
Lincolnshire	1:2,500	1886	2
Lincolnshire	1:2,500	1906	3
Ordnance Survey Plan	1:2,500	1975	4
Additional SIMs	1:2,500	1990	5
Large-Scale National Grid Data	1:2,500	1994	6

Historical Map - Segment F16

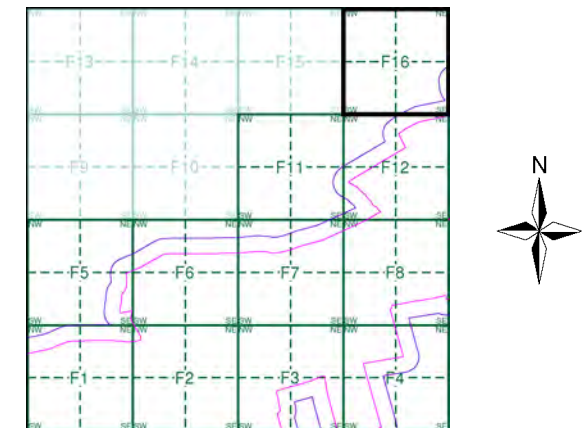

Order Details

Order Number: 297990210_1_1
 Customer Ref: 21-1088.04
 National Grid Reference: 486940, 382710
 Slice: F
 Site Area (Ha): 1120.8
 Search Buffer (m): 100

Site Details

Cottam



Tel:
Fax:
Web:



Lincolnshire
Published 1886

Source map scale - 1:2,500

The historical maps shown were reproduced from maps predominantly held at the scale adopted for England, Wales and Scotland in the 1840's. In 1854 the 1:2,500 scale was adopted for mapping urban areas and by 1896 it covered the whole of what were considered to be the cultivated parts of Great Britain. The published date given below is often some years later than the surveyed date. Before 1938, all OS maps were based on the Cassini Projection, with independent surveys of a single county or group of counties, giving rise to significant inaccuracies in outlying areas.

Map Name(s) and Date(s)

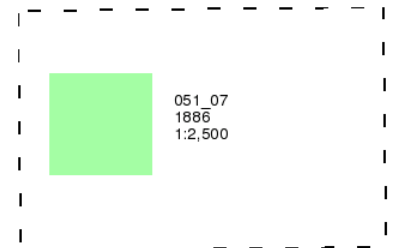

Historical Map - Segment F16

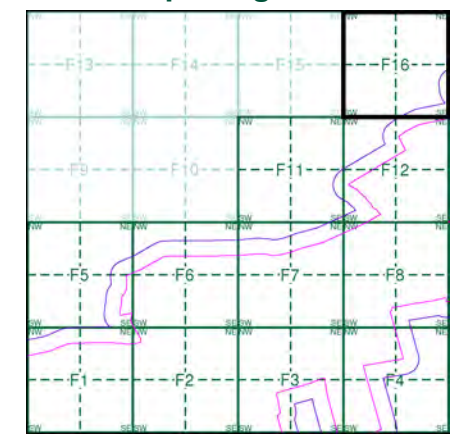

Order Details

Order Number: 297990210_1_1
Customer Ref: 21-1088.04
National Grid Reference: 486940, 382710
Slice: F
Site Area (Ha): 1120.8
Search Buffer (m): 100

Site Details

Cottam



Tel: [Redacted]
Fax: [Redacted]
Web: [Redacted]

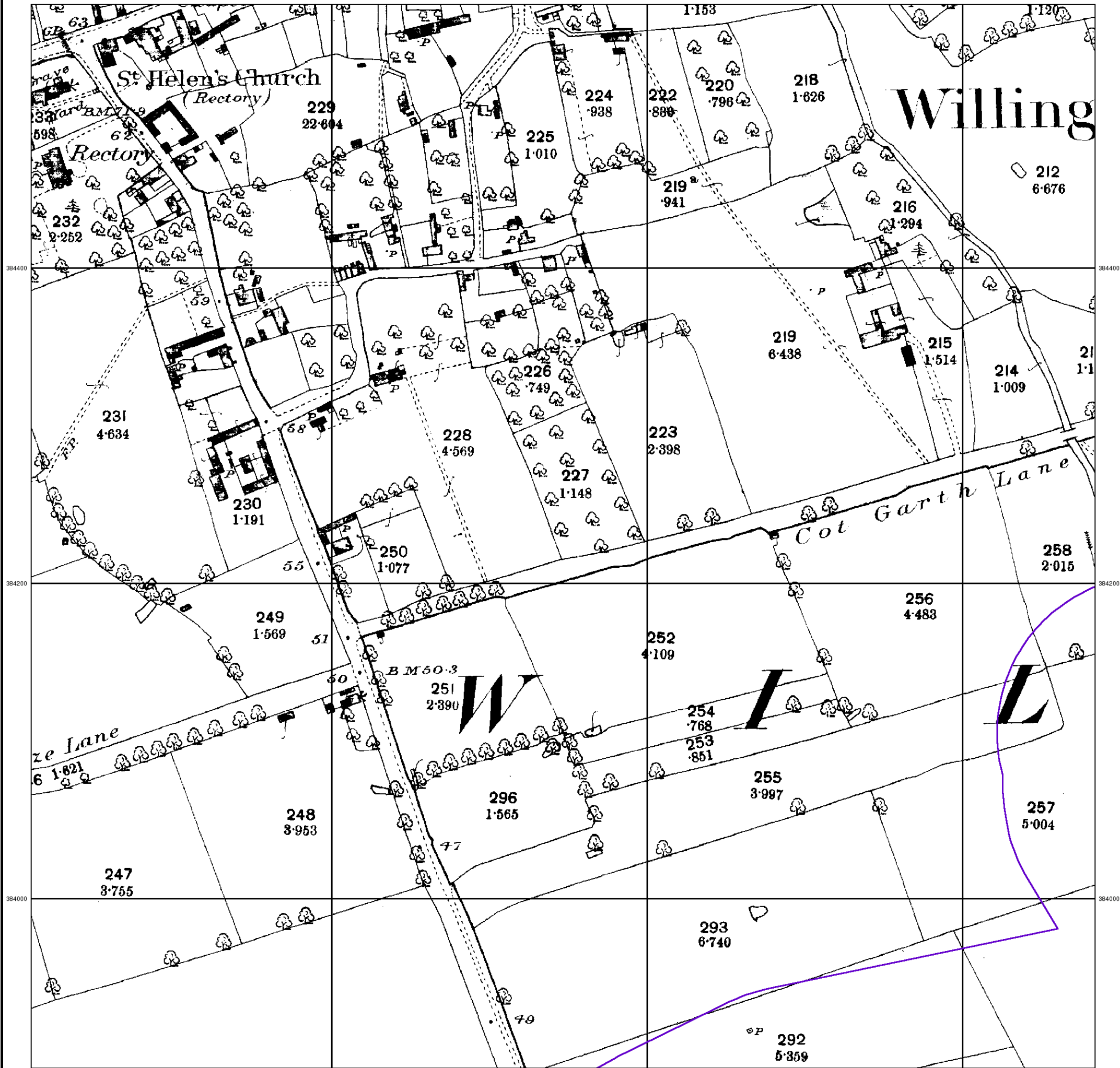



Lincolnshire
Published 1906
Source map scale - 1:2,500

The historical maps shown were reproduced from maps predominantly held at the scale adopted for England, Wales and Scotland in the 1840's. In 1854 the 1:2,500 scale was adopted for mapping urban areas and by 1896 it covered the whole of what were considered to be the cultivated parts of Great Britain. The published date given below is often some years later than the surveyed date. Before 1938, all OS maps were based on the Cassini Projection, with independent surveys of a single county or group of counties, giving rise to significant inaccuracies in outlying areas.

Map Name(s) and Date(s)

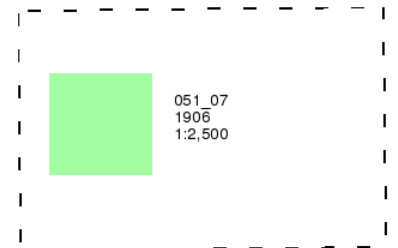

Historical Map - Segment F16

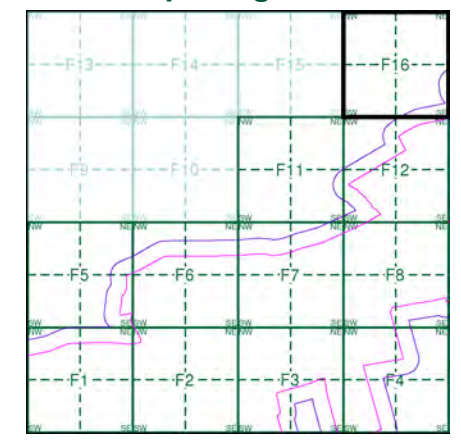

Order Details

Order Number: 297990210_1_1
Customer Ref: 21-1088.04
National Grid Reference: 486940, 382710
Slice: F
Site Area (Ha): 1120.8
Search Buffer (m): 100

Site Details

Cottam



Tel: [Redacted]
Fax: [Redacted]
Web: [Redacted]

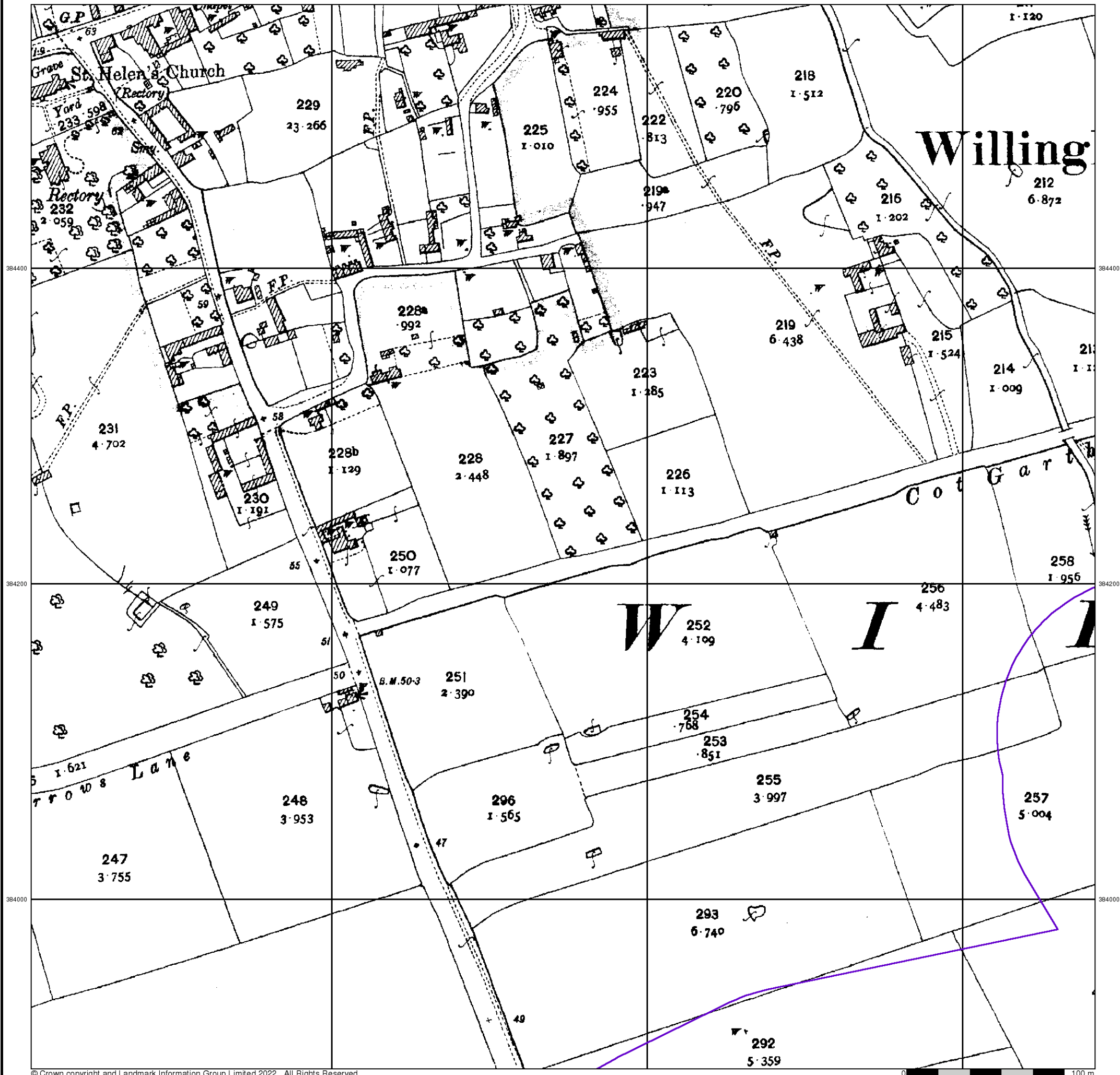

Ordnance Survey Plan

Published 1975

Source map scale - 1:2,500

The historical maps shown were reproduced from maps predominantly held at the scale adopted for England, Wales and Scotland in the 1840's. In 1854 the 1:2,500 scale was adopted for mapping urban areas and by 1896 it covered the whole of what were considered to be the cultivated parts of Great Britain. The published date given below is often some years later than the surveyed date. Before 1938, all OS maps were based on the Cassini Projection, with independent surveys of a single county or group of counties, giving rise to significant inaccuracies in outlying areas.

Map Name(s) and Date(s)

SK8784 1975 1:2,500	SK8884 1975 1:2,500
SK8783 1975 1:2,500	SK8883 1975 1:2,500

Historical Map - Segment F16

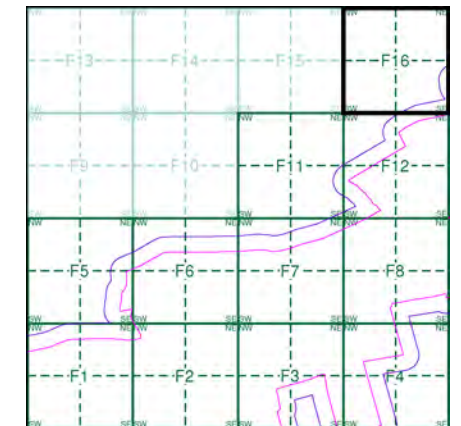

Order Details

Order Number: 297990210_1_1
 Customer Ref: 21-1088.04
 National Grid Reference: 486940, 382710
 Slice: F
 Site Area (Ha): 1120.8
 Search Buffer (m): 100

Site Details

Cottam

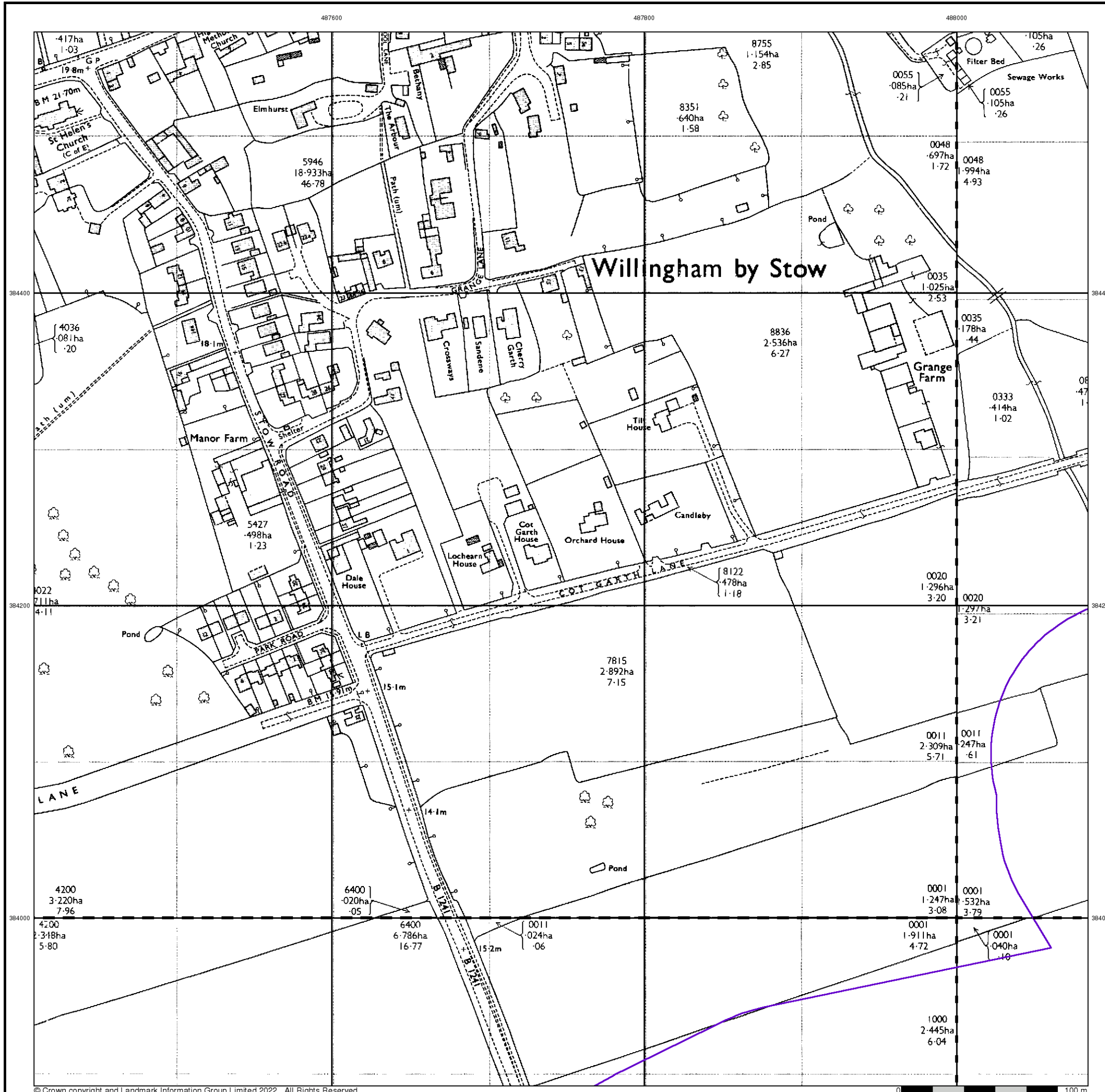

Additional SIMs

Published 1990

Source map scale - 1:2,500

The SIM cards (Ordnance Survey's 'Survey of Information on Microfilm') are further, minor editions of mapping which were produced and published in between the main editions as an area was updated. They date from 1947 to 1994, and contain detailed information on buildings, roads and land-use. These maps were produced at both 1:2,500 and 1:1,250 scales.

Map Name(s) and Date(s)

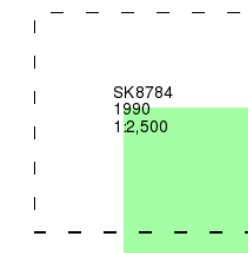

Historical Map - Segment F16

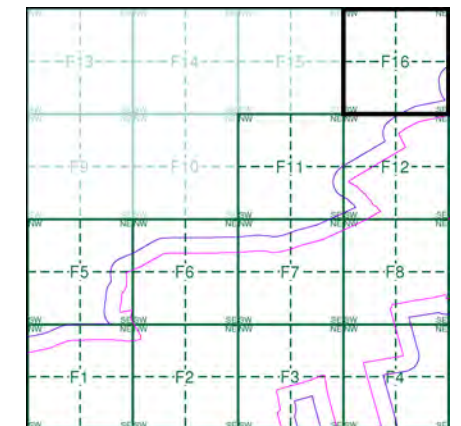

Order Details

Order Number: 297990210_1_1
 Customer Ref: 21-1088.04
 National Grid Reference: 486940, 382710
 Slice: F
 Site Area (Ha): 1120.8
 Search Buffer (m): 100

Site Details

Cottam

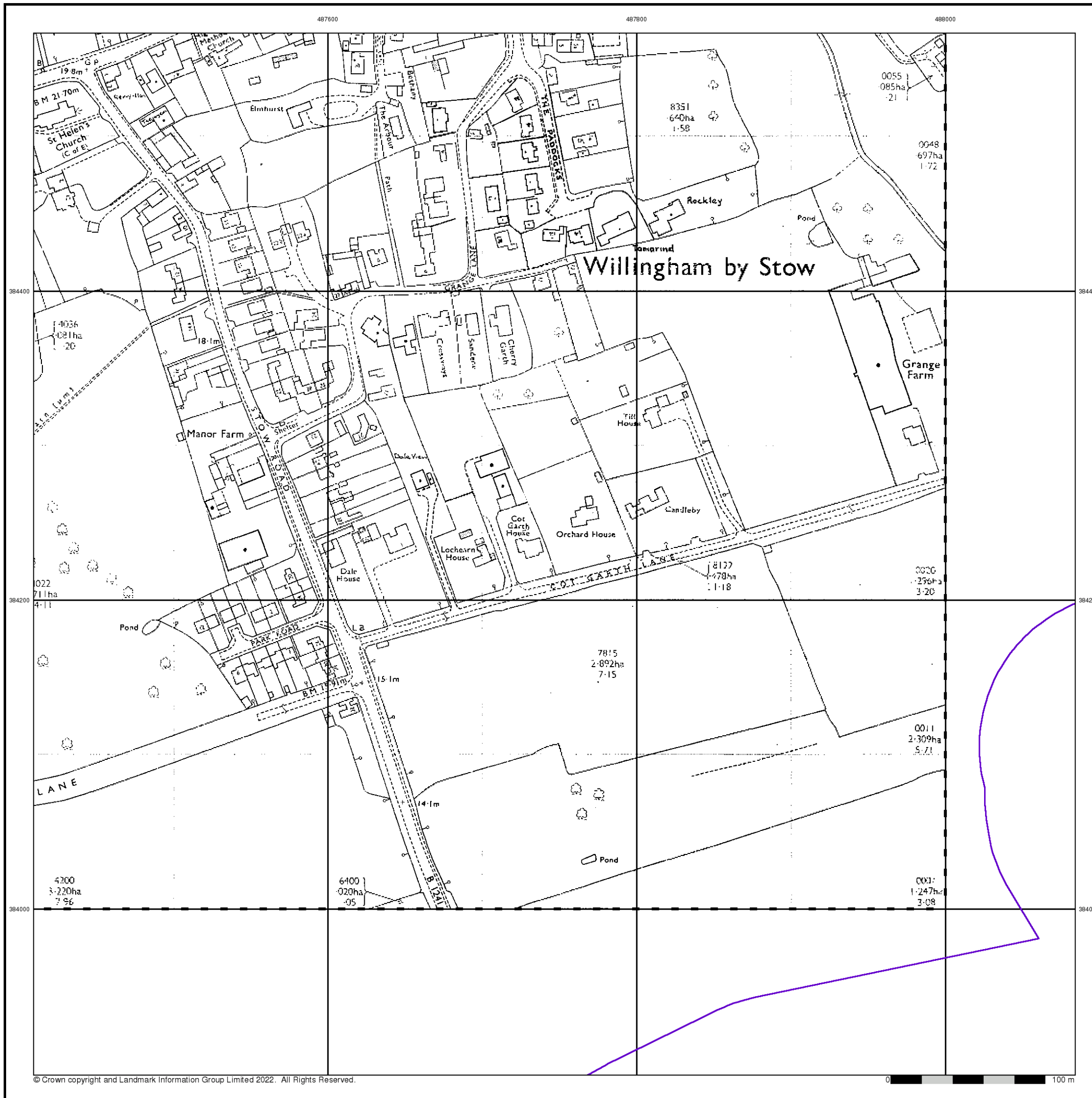

Large-Scale National Grid Data

Published 1994

Source map scale - 1:2,500

'Large Scale National Grid Data' superseded SIM cards (Ordnance Survey's 'Survey of Information on Microfilm') in 1992, and continued to be produced until 1999. These maps were the fore-runners of digital mapping and so provide detailed information on houses and roads, but tend to show less topographic features such as vegetation. These maps were produced at both 1:2,500 and 1:1,250 scales.

Map Name(s) and Date(s)

SK8784 1994 1:2,500	SK8884 1994 1:2,500
SK8783 1994 1:2,500	SK8883 1994 1:2,500

Historical Map - Segment F16

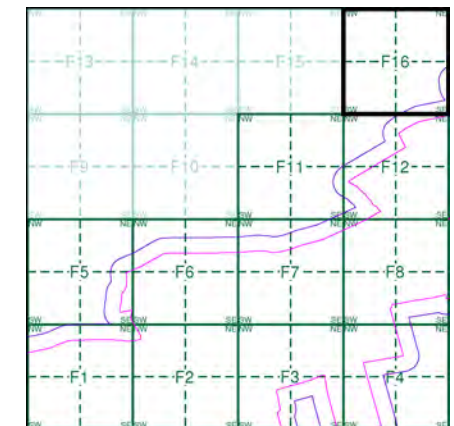

Order Details

Order Number: 297990210_1_1
 Customer Ref: 21-1088.04
 National Grid Reference: 486940, 382710
 Slice: F
 Site Area (Ha): 1120.8
 Search Buffer (m): 100

Site Details

Cottam



Historical Mapping Legends

Ordnance Survey County Series 1:10,560

- Gravel Pit
- Sand Pit
- Other Pits
- Quarry
- Shingle
- Orchard
- Osiers
- Reeds
- Marsh
- Mixed Wood
- Deciduous
- Brushwood
- Fir
- Furze
- Rough Pasture
- Arrow denotes flow of water
- Trigonometrical Station
- Site of Antiquities
- Bench Mark
- Pump, Guide Post, Signal Post
- Well, Spring, Boundary Post
- 285** Surface Level
- Sketched Contour
- Instrumental Contour
- Main Roads
- Minor Roads
- Sunken Road
- Raised Road
- Road over Railway
- Railway over River
- Railway over Road
- Level Crossing
- Road over River or Canal
- Road over Stream
- Road over Stream
- County Boundary (Geographical)
- County & Civil Parish Boundary
- Administrative County & Civil Parish Boundary
- County Borough Boundary (England)
- County Burgh Boundary (Scotland)
- Rural District Boundary
- Civil Parish Boundary

Ordnance Survey Plan 1:10,000

- Chalk Pit, Clay Pit or Quarry
- Gravel Pit
- Sand Pit
- Disused Pit or Quarry
- Refuse or Slag Heap
- Lake, Loch or Pond
- Dunes
- Boulders
- Coniferous Trees
- Non-Coniferous Trees
- Orchard
- Scrub
- Coppice
- Bracken
- Heath
- Rough Grassland
- Marsh
- Reeds
- Saltings
- Building
- Glasshouse
- Sloping Masonry
- Pylon
- Electricity Transmission Line
- Pole
- Cutting
- Embankment
- Standard Gauge Multiple Track
- Standard Gauge Single Track
- Siding, Tramway or Mineral Line
- Narrow Gauge
- Geographical County
- Administrative County, County Borough or County of City
- Municipal Borough, Urban or Rural District, Burgh or District Council
- Borough, Burgh or County Constituency
- Civil Parish
- BP, BS Boundary Post or Stone
- Ch Church
- CH Club House
- F E Sta Fire Engine Station
- FB Foot Bridge
- Fn Fountain
- GP Guide Post
- MP Mile Post
- MS Mile Stone
- Pol Sta Police Station
- PO Post Office
- PC Public Convenience
- PH Public House
- SB Signal Box
- Spr Spring
- TCB Telephone Call Box
- TCP Telephone Call Post
- W Well

1:10,000 Raster Mapping

- Gravel Pit
- Rock
- Boulders
- Shingle
- Sand
- Slopes
- General detail
- Overhead detail
- Multi-track railway
- County boundary (England only)
- District, Unitary, Metropolitan, London Borough boundary
- Area of wooded vegetation
- Non-coniferous trees (scattered)
- Coniferous trees (scattered)
- Orchard
- Rough Grassland
- Scrub
- Water feature
- MHW(S) Mean high water (springs)
- Bench mark (where shown)
- Point feature (e.g. Guide Post or Mile Stone)
- Site of (antiquity)
- General Building
- Refuse tip or slag heap
- Rock (scattered)
- Boulders (scattered)
- Mud
- Sand Pit
- Top of cliff
- Underground detail
- Narrow gauge railway
- Single track railway
- Civil, parish or community boundary
- Constituency boundary
- Non-coniferous trees
- Coniferous trees
- Positioned tree
- Coppice or Osiers
- Heath
- Marsh, Salt Marsh or Reeds
- Flow arrows
- MLW(S) Mean low water (springs)
- Triangulation station
- Pylon, flare stack or lighting tower
- Glasshouse
- Important Building



Historical Mapping & Photography included:

Mapping Type	Scale	Date	Pg
Lincolnshire	1:10,560	1885	2
Lincolnshire	1:10,560	1907	3
Lincolnshire	1:10,560	1907	4
Lincolnshire	1:10,560	1947	5
Ordnance Survey Plan	1:10,000	1956	6
Ordnance Survey Plan	1:10,000	1979	7
Ordnance Survey Plan	1:10,000	1981	8
10K Raster Mapping	1:10,000	2000	9
Street View	Variable		10

Historical Map - Slice G

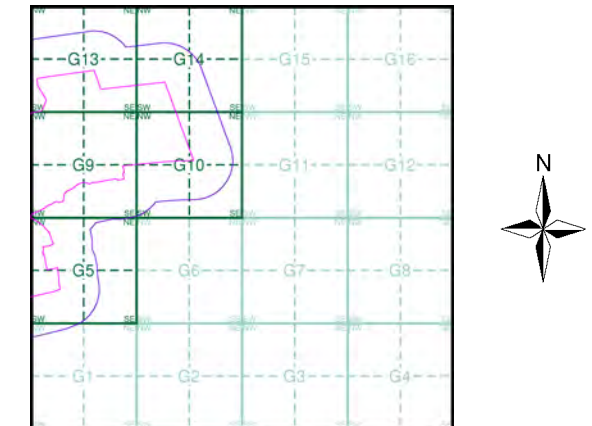

Order Details

Order Number: 297990210_1_1
 Customer Ref: 21-1088.04
 National Grid Reference: 488590, 383620
 Slice: G
 Site Area (Ha): 1120.8
 Search Buffer (m): 250

Site Details

Cottam



Tel: [Redacted]
 Fax: [Redacted]
 Web: [Redacted]

Lincolnshire

Published 1885

Source map scale - 1:10,560

The historical maps shown were reproduced from maps predominantly held at the scale adopted for England, Wales and Scotland in the 1840's. In 1854 the 1:2,500 scale was adopted for mapping urban areas; these maps were used to update the 1:10,560 maps. The published date given therefore is often some years later than the surveyed date. Before 1938, all OS maps were based on the Cassini Projection, with independent surveys of a single county or group of counties, giving rise to significant inaccuracies in outlying areas. In the late 1940's, a Provisional Edition was produced, which updated the 1:10,560 mapping from a number of sources. The maps appear unfinished - with all military camps and other strategic sites removed. These maps were initially overprinted with the National Grid. In 1970, the first 1:10,000 maps were produced using the Transverse Mercator Projection. The revision process continued until recently, with new editions appearing every 10 years or so for urban areas.

Map Name(s) and Date(s)

051NE	1885	1:10,560
051SE	1885	1:10,560

Historical Map - Slice G

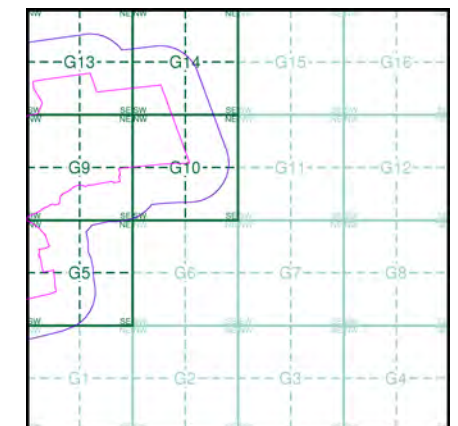

Order Details

Order Number: 297990210_1_1
 Customer Ref: 21-1088.04
 National Grid Reference: 488590, 383620
 Slice: G
 Site Area (Ha): 1120.8
 Search Buffer (m): 250

Site Details

Cottam

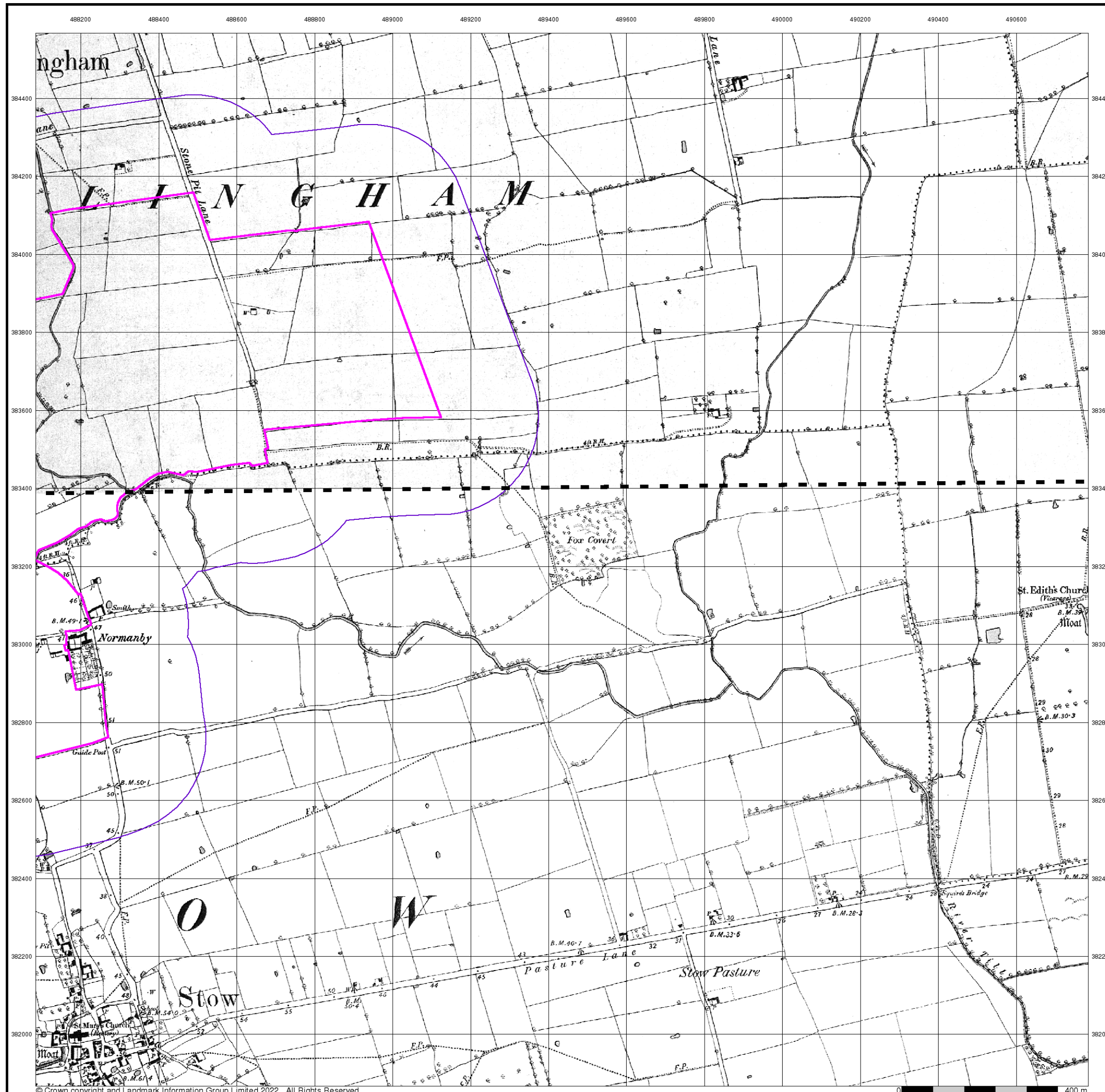

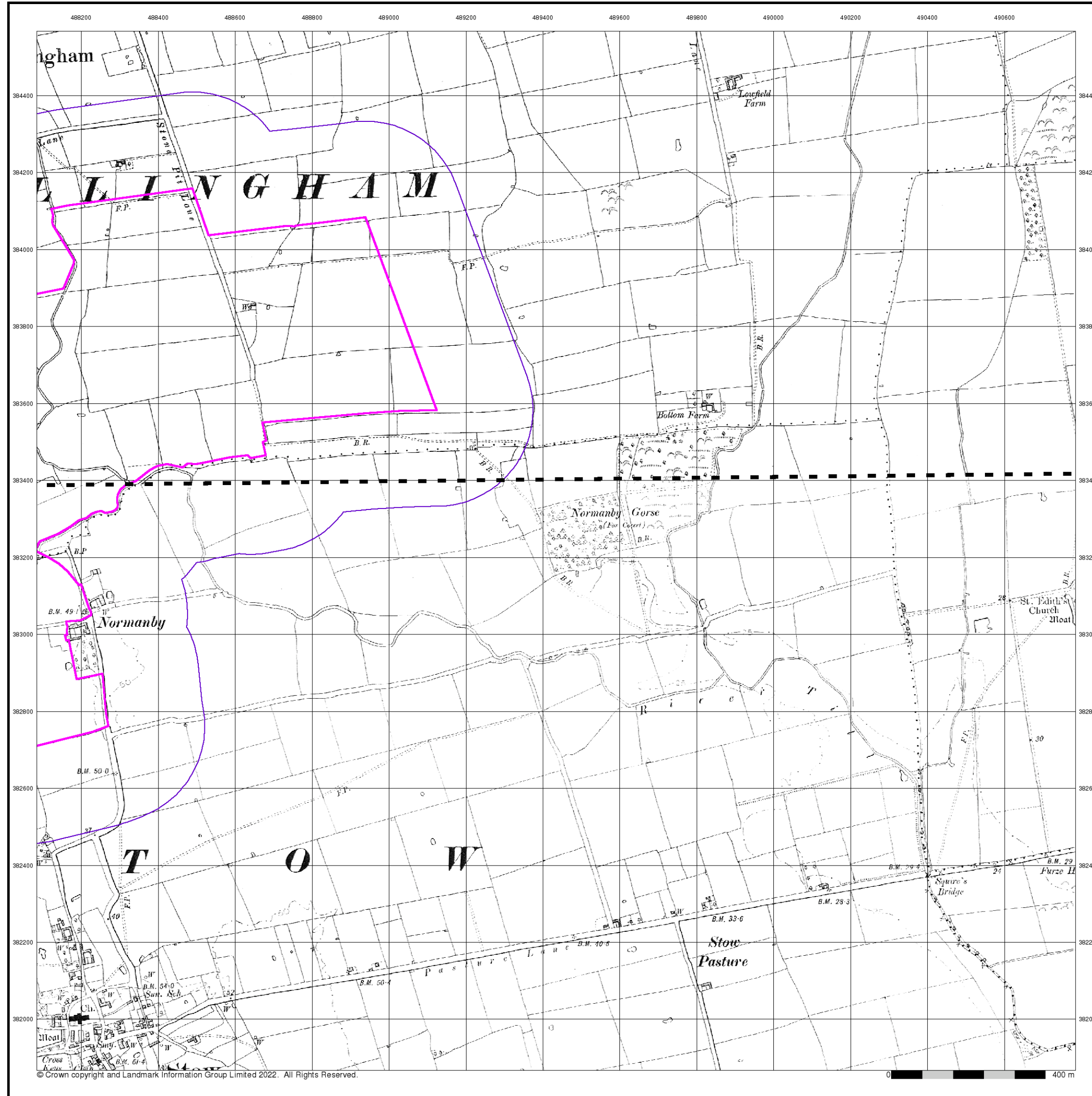

Lincolnshire

Published 1907

Source map scale - 1:10,560

The historical maps shown were reproduced from maps predominantly held at the scale adopted for England, Wales and Scotland in the 1840's. In 1854 the 1:2,500 scale was adopted for mapping urban areas; these maps were used to update the 1:10,560 maps. The published date given therefore is often some years later than the surveyed date. Before 1938, all OS maps were based on the Cassini Projection, with independent surveys of a single county or group of counties, giving rise to significant inaccuracies in outlying areas. In the late 1940's, a Provisional Edition was produced, which updated the 1:10,560 mapping from a number of sources. The maps appear unfinished - with all military camps and other strategic sites removed. These maps were initially overprinted with the National Grid. In 1970, the first 1:10,000 maps were produced using the Transverse Mercator Projection. The revision process continued until recently, with new editions appearing every 10 years or so for urban areas.

Map Name(s) and Date(s)

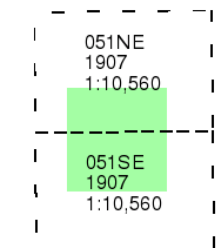

Historical Map - Slice G

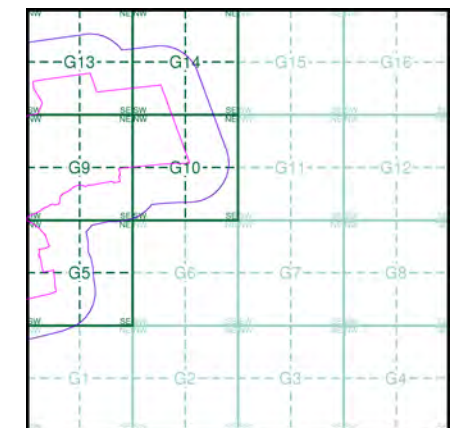

Order Details

Order Number: 297990210_1_1
 Customer Ref: 21-1088.04
 National Grid Reference: 488590, 383620
 Slice: G
 Site Area (Ha): 1120.8
 Search Buffer (m): 250

Site Details

Cottam



Tel: [Redacted]
 Fax: [Redacted]
 Web: [Redacted]

Lincolnshire

Published 1907

Source map scale - 1:10,560

The historical maps shown were reproduced from maps predominantly held at the scale adopted for England, Wales and Scotland in the 1840's. In 1854 the 1:2,500 scale was adopted for mapping urban areas; these maps were used to update the 1:10,560 maps. The published date given therefore is often some years later than the surveyed date. Before 1938, all OS maps were based on the Cassini Projection, with independent surveys of a single county or group of counties, giving rise to significant inaccuracies in outlying areas. In the late 1940's, a Provisional Edition was produced, which updated the 1:10,560 mapping from a number of sources. The maps appear unfinished - with all military camps and other strategic sites removed. These maps were initially overprinted with the National Grid. In 1970, the first 1:10,000 maps were produced using the Transverse Mercator Projection. The revision process continued until recently, with new editions appearing every 10 years or so for urban areas.

Map Name(s) and Date(s)

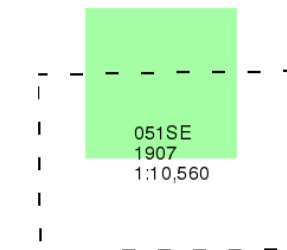

Historical Map - Slice G

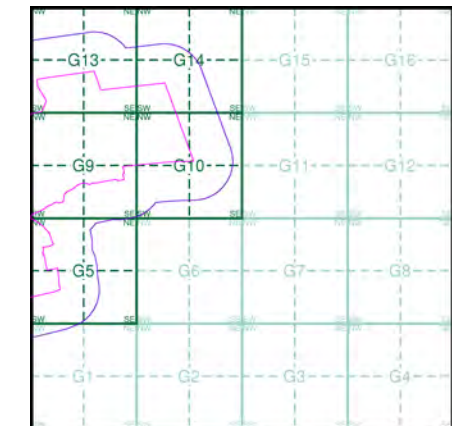

Order Details

Order Number: 297990210_1_1
 Customer Ref: 21-1088.04
 National Grid Reference: 488590, 383620
 Slice: G
 Site Area (Ha): 1120.8
 Search Buffer (m): 250

Site Details

Cottam

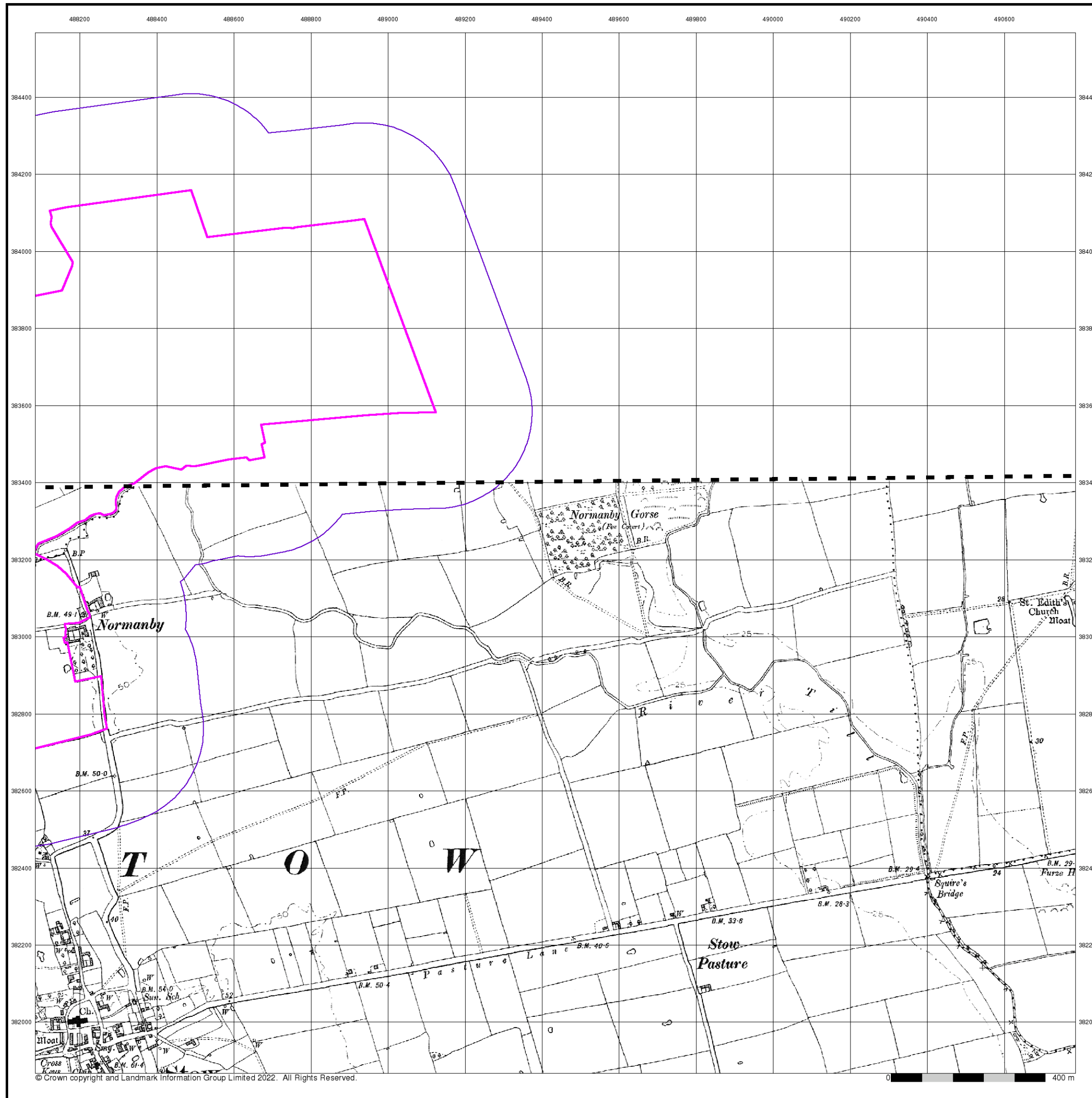

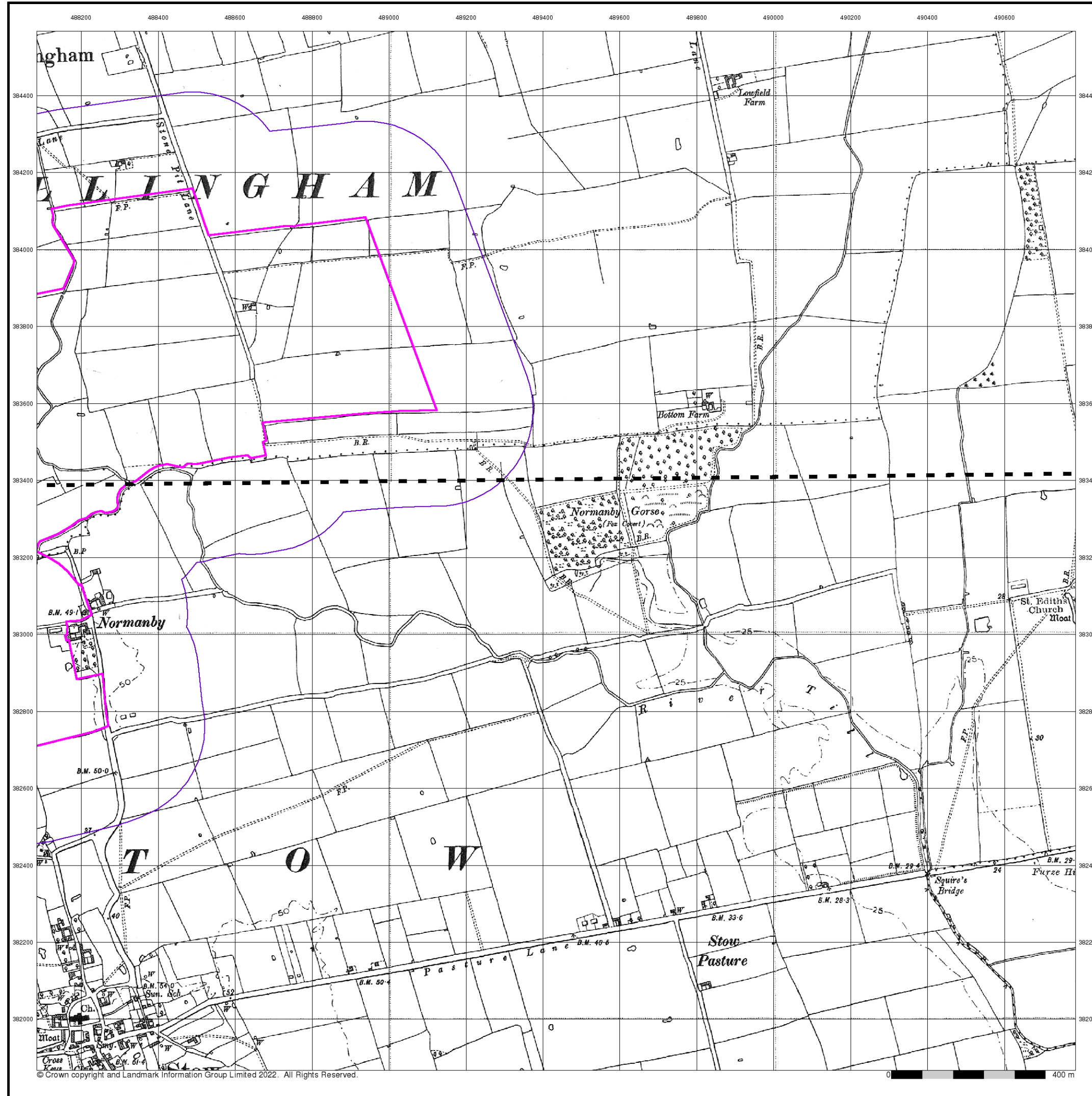

Lincolnshire

Published 1947

Source map scale - 1:10,560

The historical maps shown were reproduced from maps predominantly held at the scale adopted for England, Wales and Scotland in the 1840's. In 1854 the 1:2,500 scale was adopted for mapping urban areas; these maps were used to update the 1:10,560 maps. The published date given therefore is often some years later than the surveyed date. Before 1938, all OS maps were based on the Cassini Projection, with independent surveys of a single county or group of counties, giving rise to significant inaccuracies in outlying areas. In the late 1940's, a Provisional Edition was produced, which updated the 1:10,560 mapping from a number of sources. The maps appear unfinished - with all military camps and other strategic sites removed. These maps were initially overprinted with the National Grid. In 1970, the first 1:10,000 maps were produced using the Transverse Mercator Projection. The revision process continued until recently, with new editions appearing every 10 years or so for urban areas.

Map Name(s) and Date(s)

051NE	1947	1:10,560
051SE	1947	1:10,560

Historical Map - Slice G

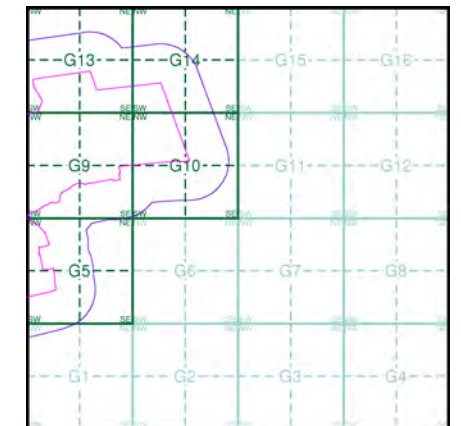

Order Details

Order Number: 297990210_1_1
 Customer Ref: 21-1088.04
 National Grid Reference: 488590, 383620
 Slice: G
 Site Area (Ha): 1120.8
 Search Buffer (m): 250

Site Details

Cottam



Tel: [Redacted]
 Fax: [Redacted]
 Web: [Redacted]

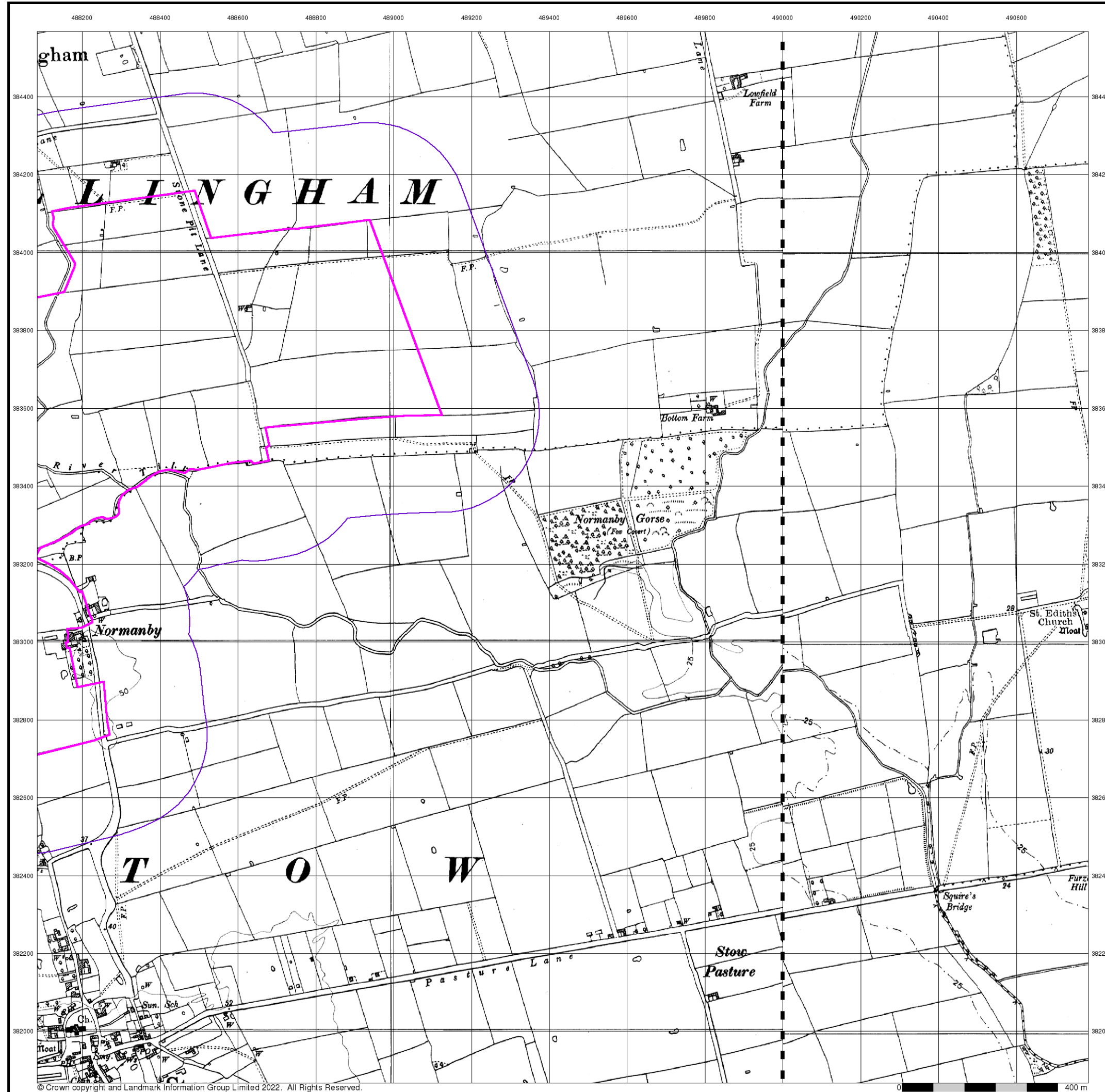

© Crown copyright and Landmark Information Group Limited 2022. All Rights Reserved.



Ordnance Survey Plan
Published 1956
Source map scale - 1:10,000

The historical maps shown were reproduced from maps predominantly held at the scale adopted for England, Wales and Scotland in the 1840's. In 1854 the 1:2,500 scale was adopted for mapping urban areas; these maps were used to update the 1:10,560 maps. The published date given therefore is often some years later than the surveyed date. Before 1938, all OS maps were based on the Cassini Projection, with independent surveys of a single county or group of counties, giving rise to significant inaccuracies in outlying areas. In the late 1940's, a Provisional Edition was produced, which updated the 1:10,560 mapping from a number of sources. The maps appear unfinished - with all military camps and other strategic sites removed. These maps were initially overprinted with the National Grid. In 1970, the first 1:10,000 maps were produced using the Transverse Mercator Projection. The revision process continued until recently, with new editions appearing every 10 years or so for urban areas.

Map Name(s) and Date(s)

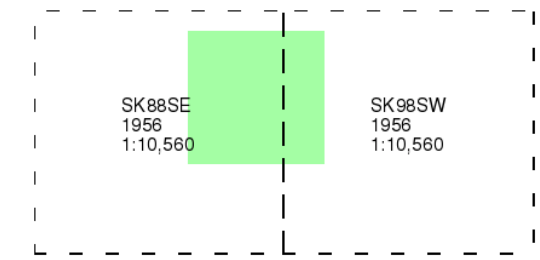

Historical Map - Slice G

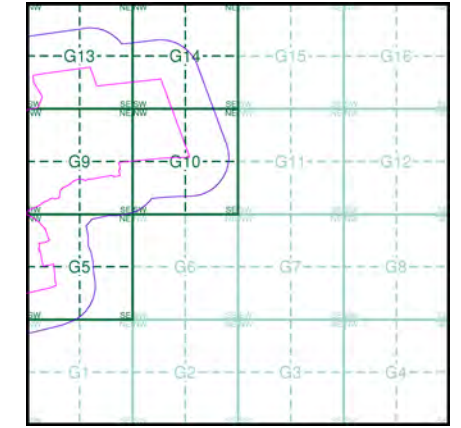

Order Details
 Order Number: 297990210_1_1
 Customer Ref: 21-1088.04
 National Grid Reference: 488590, 383620
 Slice: G
 Site Area (Ha): 1120.8
 Search Buffer (m): 250

Site Details
 Cottam



Ordnance Survey Plan

Published 1979

Source map scale - 1:10,000

The historical maps shown were reproduced from maps predominantly held at the scale adopted for England, Wales and Scotland in the 1840's. In 1854 the 1:2,500 scale was adopted for mapping urban areas; these maps were used to update the 1:10,560 maps. The published date given therefore is often some years later than the surveyed date. Before 1938, all OS maps were based on the Cassini Projection, with independent surveys of a single county or group of counties, giving rise to significant inaccuracies in outlying areas. In the late 1940's, a Provisional Edition was produced, which updated the 1:10,560 mapping from a number of sources. The maps appear unfinished - with all military camps and other strategic sites removed. These maps were initially overprinted with the National Grid. In 1970, the first 1:10,000 maps were produced using the Transverse Mercator Projection. The revision process continued until recently, with new editions appearing every 10 years or so for urban areas.

Map Name(s) and Date(s)

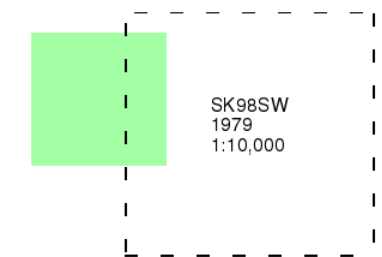

Historical Map - Slice G

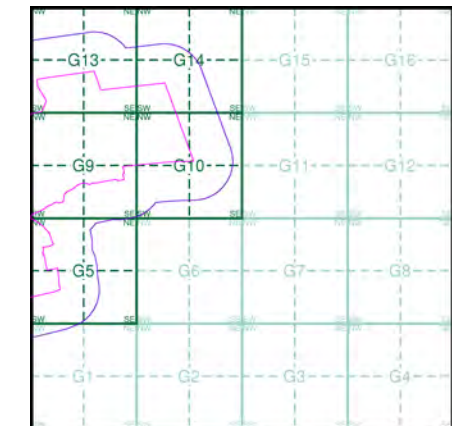

Order Details

Order Number: 297990210_1_1
 Customer Ref: 21-1088.04
 National Grid Reference: 488590, 383620
 Slice: G
 Site Area (Ha): 1120.8
 Search Buffer (m): 250

Site Details

Cottam

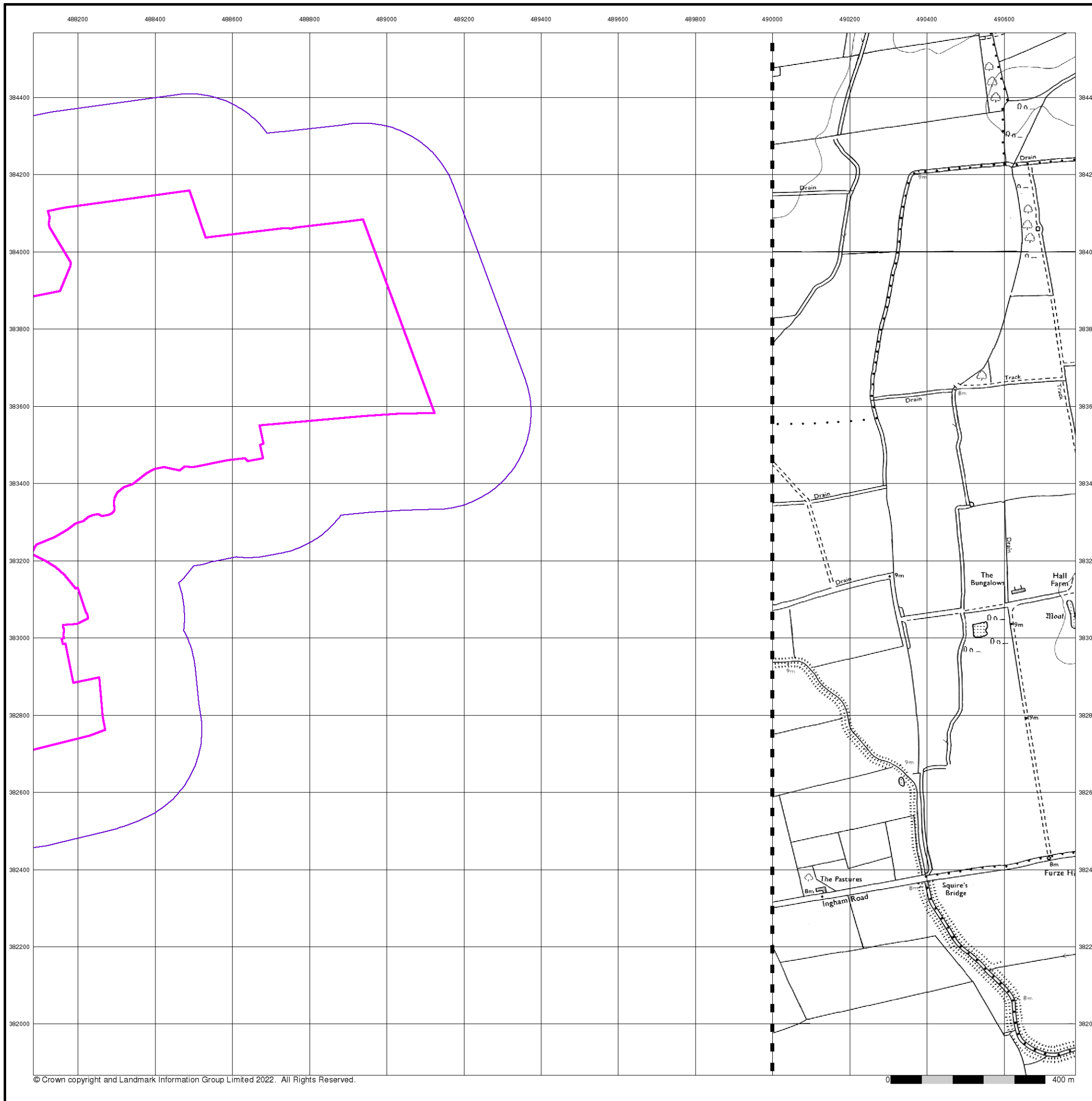

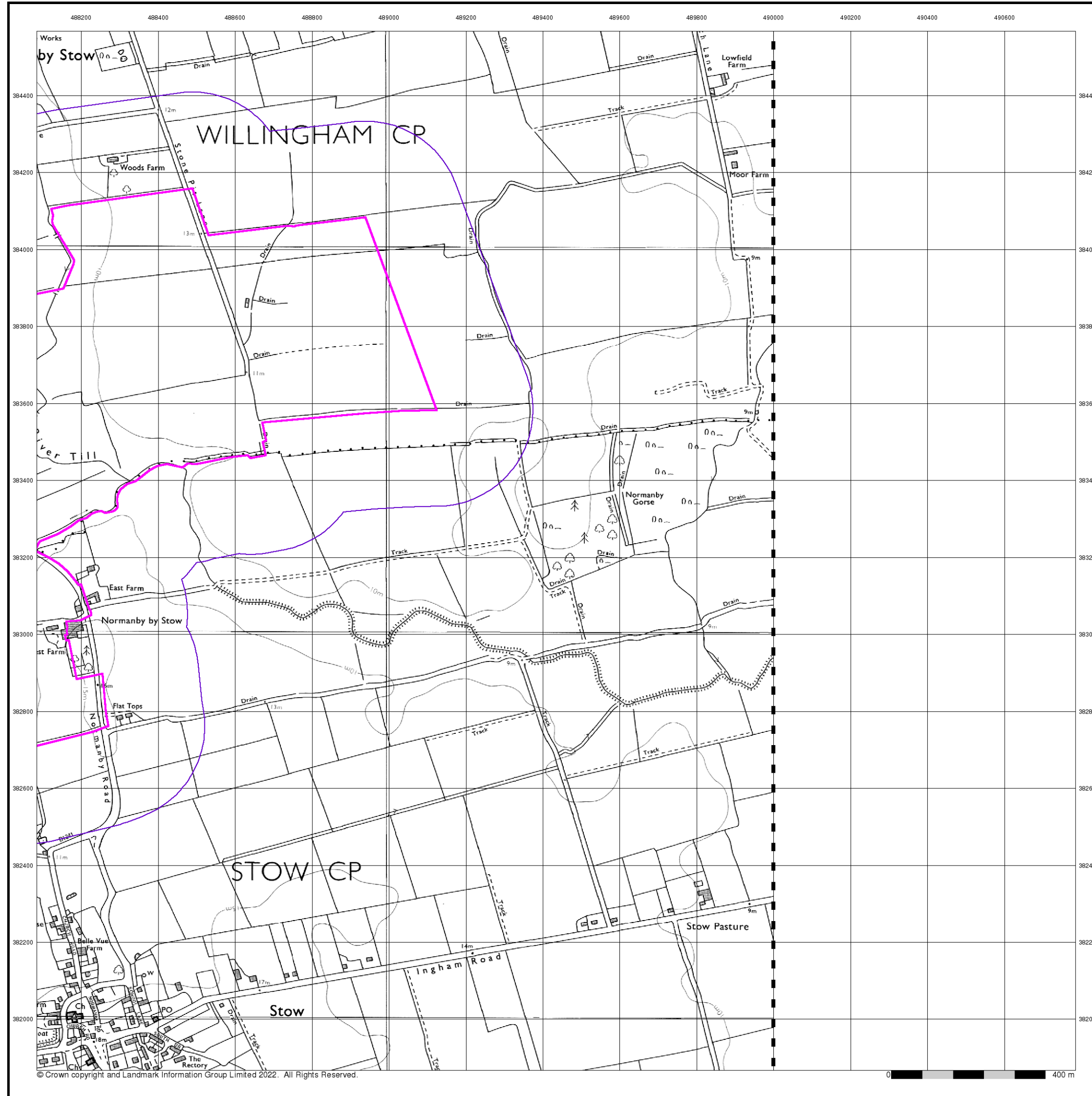

© Crown copyright and Landmark Information Group Limited 2022. All Rights Reserved.



Ordnance Survey Plan
Published 1981
Source map scale - 1:10,000

The historical maps shown were reproduced from maps predominantly held at the scale adopted for England, Wales and Scotland in the 1840's. In 1854 the 1:2,500 scale was adopted for mapping urban areas; these maps were used to update the 1:10,560 maps. The published date given therefore is often some years later than the surveyed date. Before 1938, all OS maps were based on the Cassini Projection, with independent surveys of a single county or group of counties, giving rise to significant inaccuracies in outlying areas. In the late 1940's, a Provisional Edition was produced, which updated the 1:10,560 mapping from a number of sources. The maps appear unfinished - with all military camps and other strategic sites removed. These maps were initially overprinted with the National Grid. In 1970, the first 1:10,000 maps were produced using the Transverse Mercator Projection. The revision process continued until recently, with new editions appearing every 10 years or so for urban areas.

Map Name(s) and Date(s)

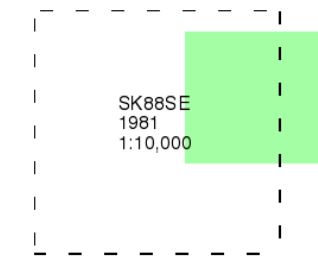

Historical Map - Slice G

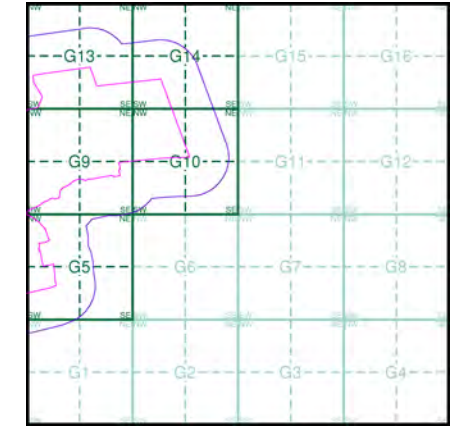

Order Details

Order Number: 297990210_1_1
 Customer Ref: 21-1088.04
 National Grid Reference: 488590, 383620
 Slice: G
 Site Area (Ha): 1120.8
 Search Buffer (m): 250

Site Details

Cottam



Tel: [Redacted]
 Fax: [Redacted]
 Web: [Redacted]

10k Raster Mapping

Published 2000

Source map scale - 1:10,000

The historical maps shown were produced from the Ordnance Survey's 1:10,000 colour raster mapping. These maps are derived from Landplan which replaced the old 1:10,000 maps originally published in 1970. The data is highly detailed showing buildings, fences and field boundaries as well as all roads, tracks and paths. Road names are also included together with the relevant road number and classification. Boundary information depiction includes county, unitary authority, district, civil parish and constituency.

Map Name(s) and Date(s)

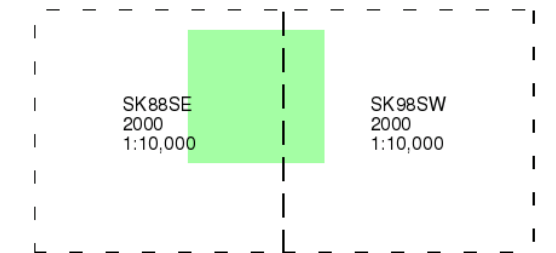

Historical Map - Slice G

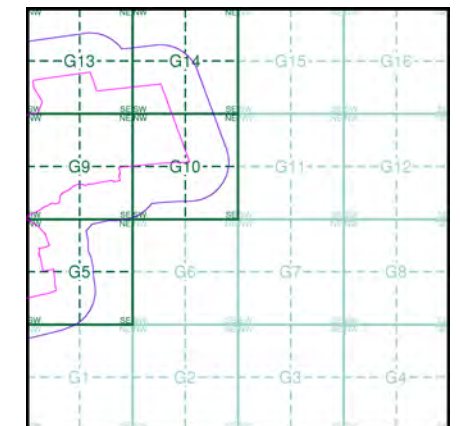

Order Details

Order Number: 297990210_1_1
 Customer Ref: 21-1088.04
 National Grid Reference: 488590, 383620
 Slice: G
 Site Area (Ha): 1120.8
 Search Buffer (m): 250

Site Details

Cottam

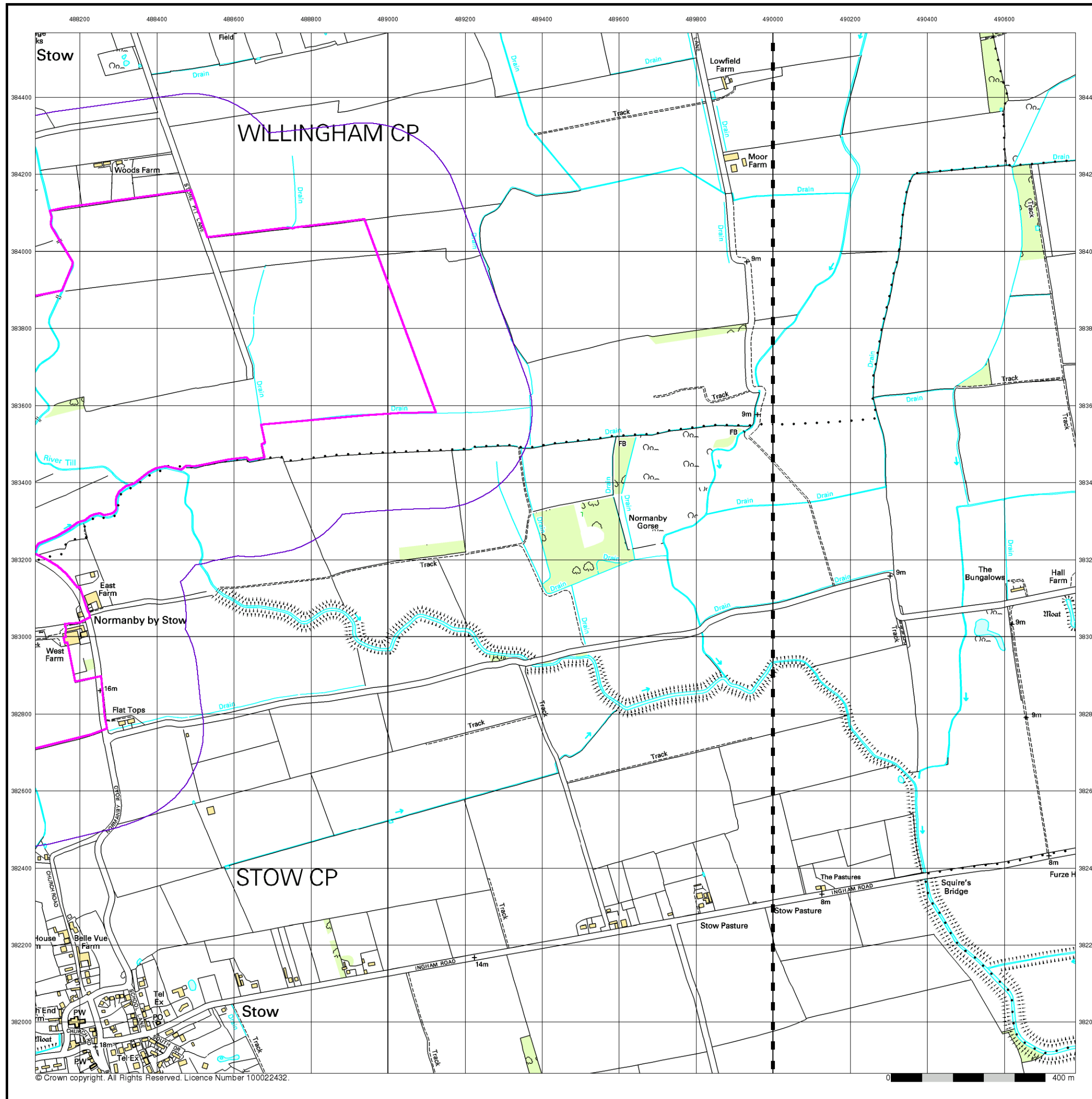

© Crown copyright. All Rights Reserved. Licence Number 100022432.

Street View

Published 2022

Source map scale - 1:10,000

Street View is a street-level map for the whole of Great Britain produced by the Ordnance Survey. These maps are provided at a nominal scale of 1:10,000

Map Name(s) and Date(s)



Street View Map - Slice G

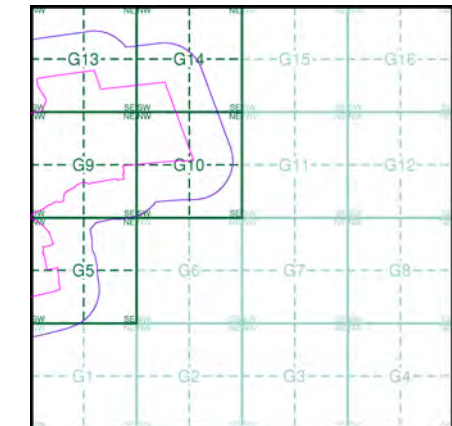

Order Details

Order Number: 297990210_1_1
 Customer Ref: 21-1088.04
 National Grid Reference: 488590, 383620
 Slice: G
 Site Area (Ha): 1120.8
 Search Buffer (m): 250

Site Details

Cottam

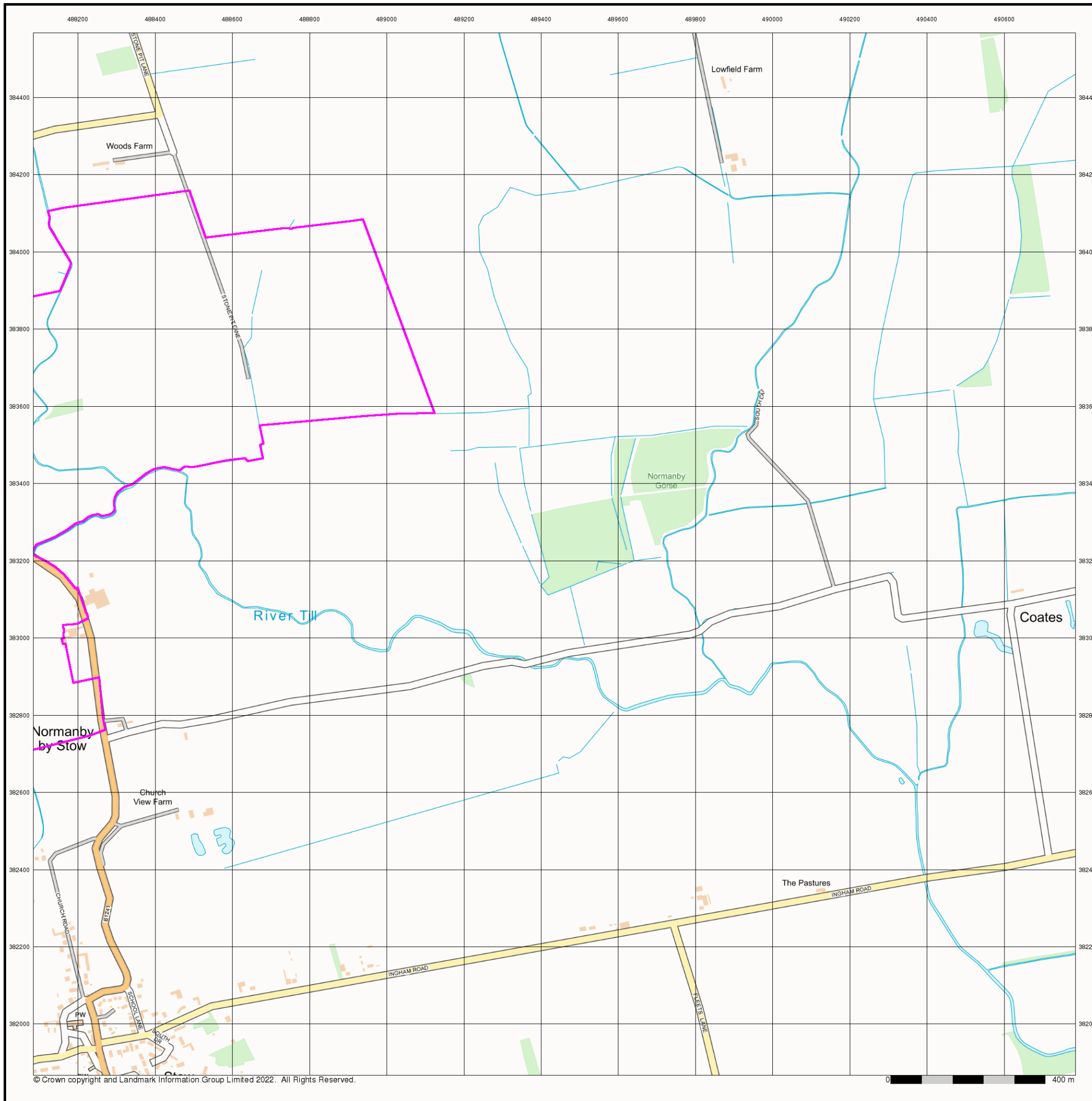

Historical Mapping Legends

Ordnance Survey County Series and Ordnance Survey Plan 1:2,500

Quarry **Gravel Pit** **Sand Pit**
Clay Pit **Shingle** **Refuse Heap**
Sloping Masonry **Flat Rock**
Marsh **Reeds** **Osiers**
Rough Pasture **Furze** **Wood**
Mixed Wood **Brushwood** **Orchard**
Fir **Ford** **Stepping Stones**
Ferry **Waterfall** **Lock**
Trig. Station **Altitude at Trig. Station**
B.M. 325.9 **Bench Mark** **Surface Level**
Arrow denotes flow of water **Antiquities (site of)**
Cutting **Embankment**
Railway crossing Road **Level Crossing** **Road crossing Railway**
Railway crossing River or Canal **Road over single stream** **Road over River or Canal**
County Boundary (Geographical)
County & Civil Parish Boundary
Administrative County & Civil Parish Boundary
County Borough Boundary (England)
Co. Boro. Bdy.
County Burgh Boundary (Scotland)
Co. Burgh Bdy.
BP BS Boundary Post or Stone **P.C.B** Police Call Box
B.R. Bridle Road **P** Pump
E.P Electricity Pylon **S.P** Signal Post
F.B. Foot Bridge **SL** Sluice
F.P. Foot Path **Sp.** Spring
G.P Guide Post or Board **T.C.B** Telephone Call Box
M.S Mile Stone **Tr.** Trough
M.P M.R Mooring Post or Ring **W** Well

Ordnance Survey Plan, Additional SIMs and Supply of Unpublished Survey Information 1:2,500 and 1:1,250

Inactive Quarry, Chalk Pit or Clay Pit **Active Quarry, Chalk Pit or Clay Pit**
Rock **Boulders**
Cliff **Slopes** **Top**
Roofed Building **Glazed Roof Building**
Sloping Masonry **Archway**
Non-Coniferous Tree (surveyed) **Coniferous Tree (surveyed)**
Non-Coniferous Trees (not surveyed) **Coniferous Trees (not surveyed)**
Orchard Tree **Scrub** **Bracken**
Coppice, Osier **Reeds** **Marsh, Saltings**
Rough Grassland **Heath** **Culvert**
Direction of water flow **Bench Mark** **Antiquity (site of)**
Cave Entrance **Triangulation Station** **Electricity Pylon**
Electricity Transmission Line
County Boundary (Geographical)
County & Civil Parish Boundary
Civil Parish Boundary
Admin. County or County Bor. Boundary
London Borough Boundary
Symbol marking point where boundary mereing changes
BH Beer House **P** Pillar, Pole or Post
BP, BS Boundary Post or Stone **PO** Post Office
Cn, C Capstan, Crane **PC** Public Convenience
Chy Chimney **PH** Public House
D Fn Drinking Fountain **Pp** Pump
EI P Electricity Pillar or Post **SB, S Br** Signal Box or Bridge
FAP Fire Alarm Pillar **SP, SL** Signal Post or Light
FB Foot Bridge **Spr** Spring
GP Guide Post **Tk** Tank or Track
H Hydrant or Hydraulic **TCB** Telephone Call Box
LC Level Crossing **TCP** Telephone Call Post
MH Manhole **Tr** Trough
MP Mile Post or Mooring Post **Wr Pt, Wr T** Water Point, Water Tap
MS Mile Stone **W** Well
NTL Normal Tidal Limit **Wd Pp** Wind Pump

Large-Scale National Grid Data 1:2,500 and 1:1,250

Cliff **Slopes** **Top**
Rock **Rock (scattered)**
Boulders **Boulders (scattered)**
Positioned Boulder **Scree**
Non-Coniferous Tree (surveyed) **Coniferous Tree (surveyed)**
Non-Coniferous Trees (not surveyed) **Coniferous Trees (not surveyed)**
Orchard Tree **Scrub** **Bracken**
Coppice, Osier **Reeds** **Marsh, Saltings**
Rough Grassland **Heath** **Culvert**
Direction of water flow **Triangulation Station** **Antiquity (site of)**
Electricity Transmission Line **Electricity Pylon**
B.M. 231.60m **Bench Mark** **Buildings with Building Seed**
Roofed Building **Glazed Roof Building**
Civil parish/community boundary
District boundary
County boundary
Boundary post/stone
Boundary mereing symbol (note: these always appear in opposed pairs or groups of three)
Bks Barracks **P** Pillar, Pole or Post
Bty Battery **PO** Post Office
Cemy Cemetery **PC** Public Convenience
Chy Chimney **Pp** Pump
Cis Cistern **Ppg Sta** Pumping Station
Dismtd Rly Dismantled Railway **PW** Place of Worship
EI Gen Sta Electricity Generating Station **Sewage Ppg Sta** Sewage Pumping Station
EI P Electricity Pole, Pillar **SB, S Br** Signal Box or Bridge
EI Sub Sta Electricity Sub Station **SP, SL** Signal Post or Light
FB Filter Bed **Spr** Spring
Fn / D Fn Fountain / Drinking Ftn. **Tk** Tank or Track
Gas Gov Gas Valve Compound **Tr** Trough
GVC Gas Governor **Wd Pp** Wind Pump
GP Guide Post **Wr Pt, Wr T** Water Point, Water Tap
MH Manhole **Wks** Works (building or area)
MP, MS Mile Post or Mile Stone **W** Well



Historical Mapping & Photography included:

Mapping Type	Scale	Date	Pg
Lincolnshire	1:2,500	1886	2
Lincolnshire	1:2,500	1906	3
Ordnance Survey Plan	1:2,500	1975	4
Large-Scale National Grid Data	1:2,500	1994	5

Historical Map - Segment G5

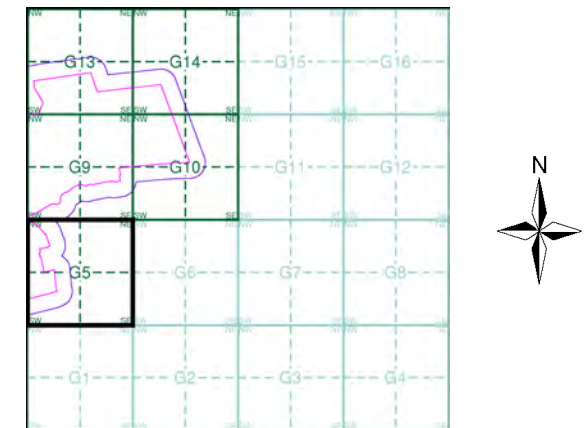

Order Details

Order Number: 297990210_1_1
 Customer Ref: 21-1088.04
 National Grid Reference: 488590, 383620
 Slice: G
 Site Area (Ha): 1120.8
 Search Buffer (m): 100

Site Details

Cottam



Tel: [Redacted]
 Fax: [Redacted]
 Web: [Redacted]

Lincolnshire
Published 1886

Source map scale - 1:2,500

The historical maps shown were reproduced from maps predominantly held at the scale adopted for England, Wales and Scotland in the 1840's. In 1854 the 1:2,500 scale was adopted for mapping urban areas and by 1896 it covered the whole of what were considered to be the cultivated parts of Great Britain. The published date given below is often some years later than the surveyed date. Before 1938, all OS maps were based on the Cassini Projection, with independent surveys of a single county or group of counties, giving rise to significant inaccuracies in outlying areas.

Map Name(s) and Date(s)

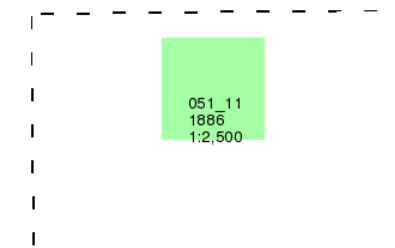

Historical Map - Segment G5

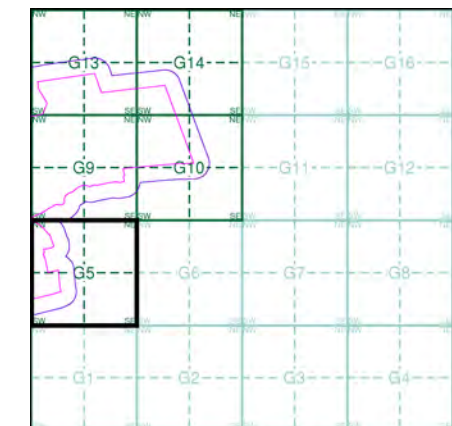

Order Details

Order Number: 297990210_1_1
 Customer Ref: 21-1088.04
 National Grid Reference: 488590, 383620
 Slice: G
 Site Area (Ha): 1120.8
 Search Buffer (m): 100

Site Details

Cottam

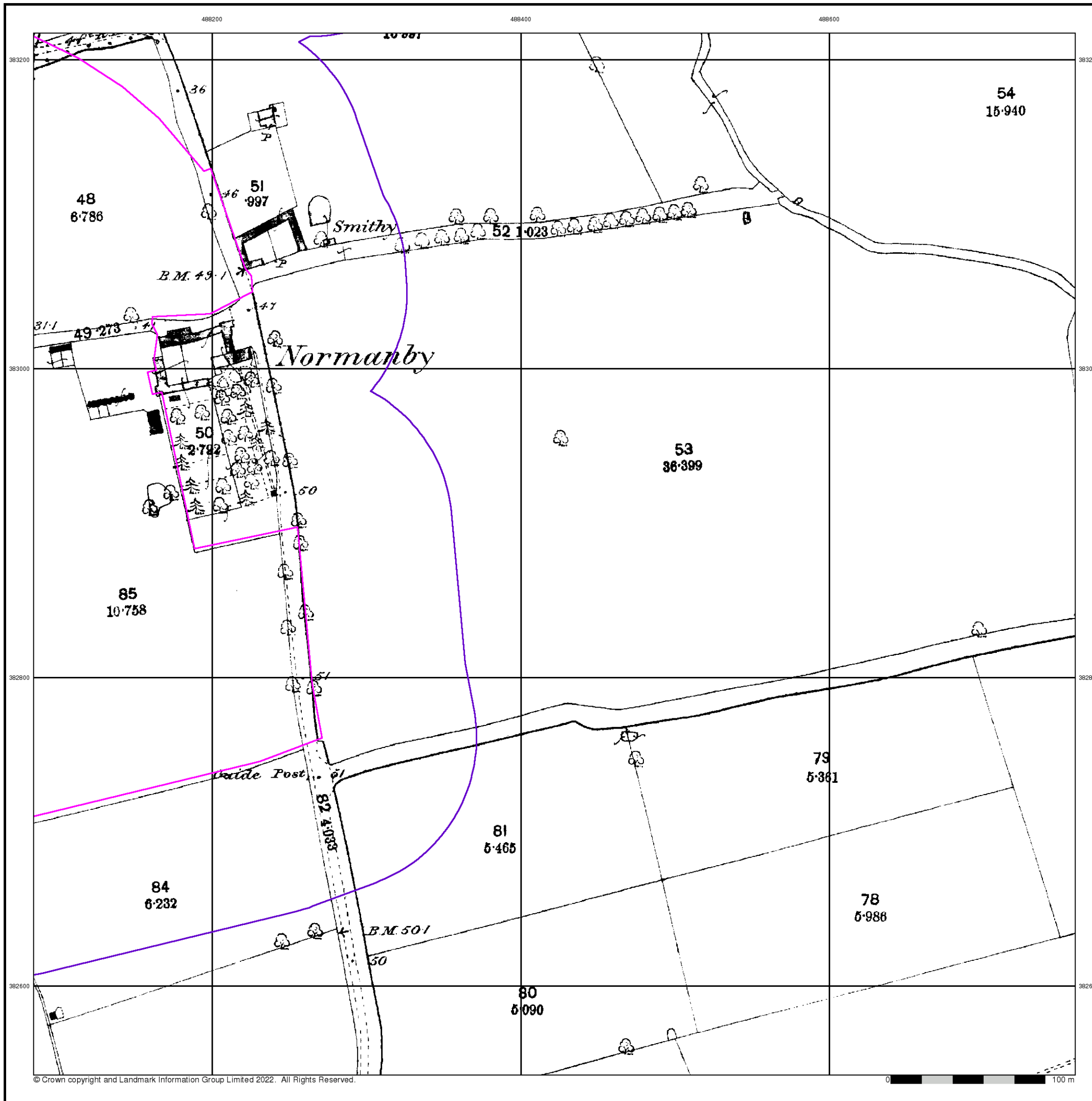

Lincolnshire

Published 1906

Source map scale - 1:2,500

The historical maps shown were reproduced from maps predominantly held at the scale adopted for England, Wales and Scotland in the 1840's. In 1854 the 1:2,500 scale was adopted for mapping urban areas and by 1896 it covered the whole of what were considered to be the cultivated parts of Great Britain. The published date given below is often some years later than the surveyed date. Before 1938, all OS maps were based on the Cassini Projection, with independent surveys of a single county or group of counties, giving rise to significant inaccuracies in outlying areas.

Map Name(s) and Date(s)

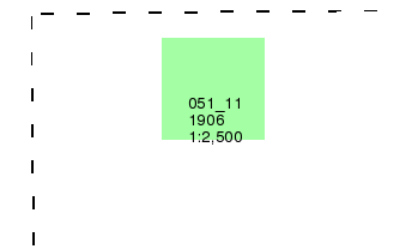

Historical Map - Segment G5

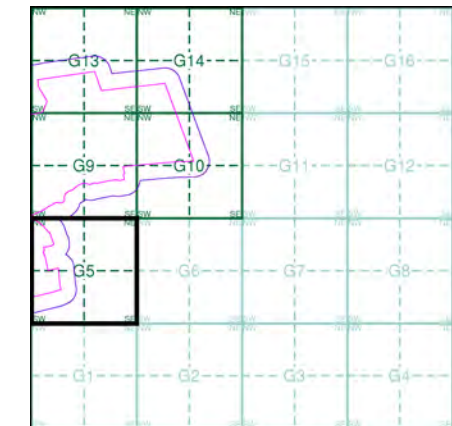

Order Details

Order Number: 297990210_1_1
 Customer Ref: 21-1088.04
 National Grid Reference: 488590, 383620
 Slice: G
 Site Area (Ha): 1120.8
 Search Buffer (m): 100

Site Details

Cottam

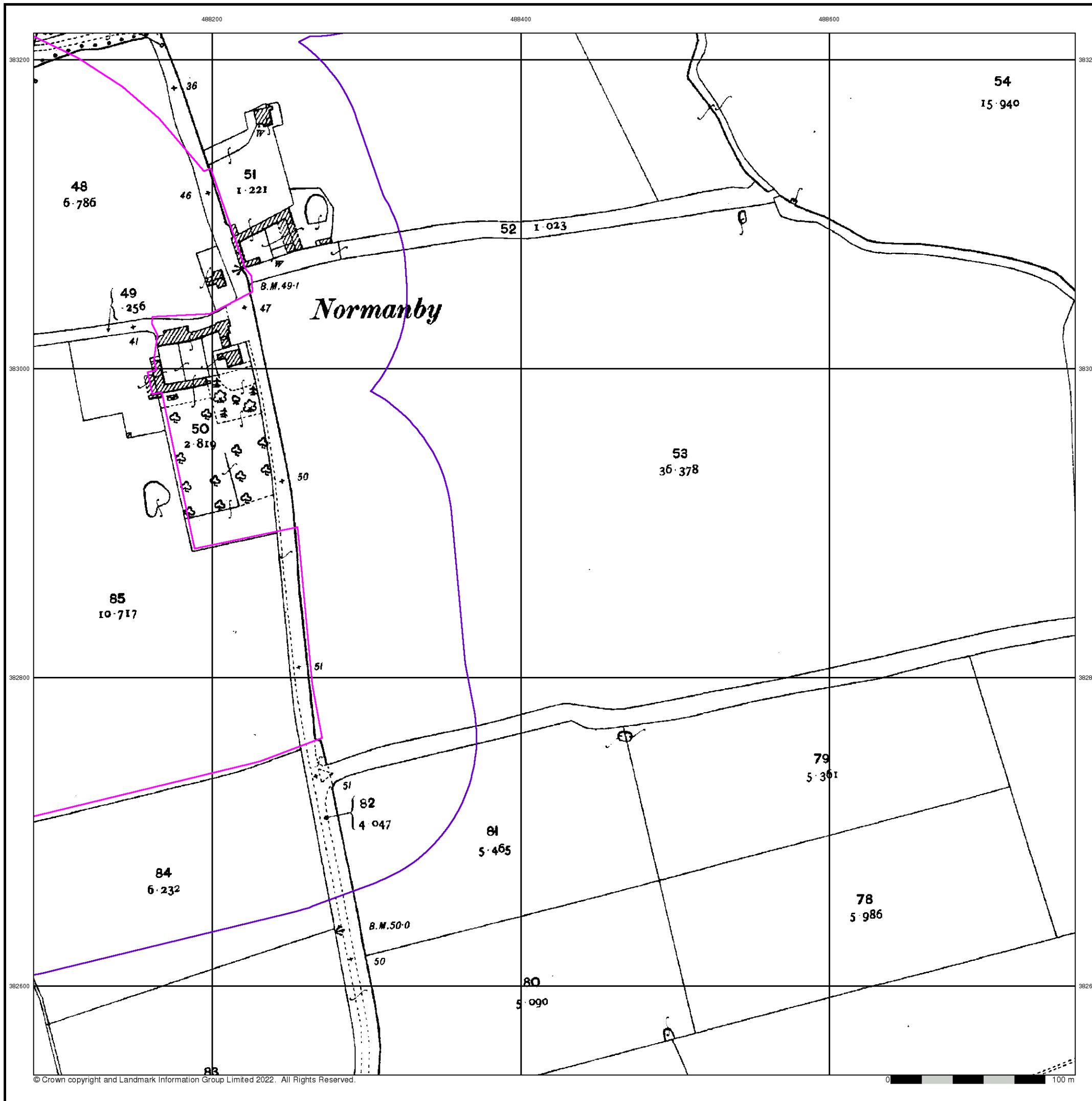

Ordnance Survey Plan

Published 1975

Source map scale - 1:2,500

The historical maps shown were reproduced from maps predominantly held at the scale adopted for England, Wales and Scotland in the 1840's. In 1854 the 1:2,500 scale was adopted for mapping urban areas and by 1896 it covered the whole of what were considered to be the cultivated parts of Great Britain. The published date given below is often some years later than the surveyed date. Before 1938, all OS maps were based on the Cassini Projection, with independent surveys of a single county or group of counties, giving rise to significant inaccuracies in outlying areas.

Map Name(s) and Date(s)

SK8883	1975	1:2,500
SK8882	1975	1:2,500

Historical Map - Segment G5

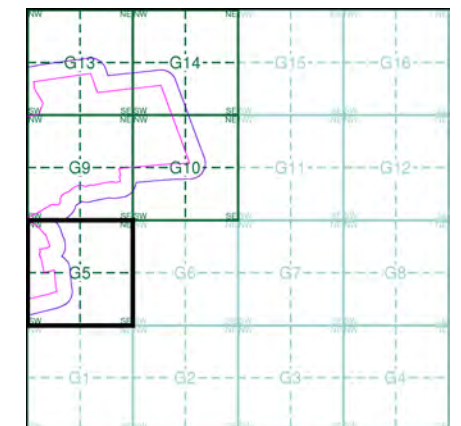

Order Details

Order Number: 297990210_1_1
 Customer Ref: 21-1088.04
 National Grid Reference: 488590, 383620
 Slice: G
 Site Area (Ha): 1120.8
 Search Buffer (m): 100

Site Details

Cottam



Large-Scale National Grid Data

Published 1994

Source map scale - 1:2,500

'Large Scale National Grid Data' superseded SIM cards (Ordnance Survey's 'Survey of Information on Microfilm') in 1992, and continued to be produced until 1999. These maps were the fore-runners of digital mapping and so provide detailed information on houses and roads, but tend to show less topographic features such as vegetation. These maps were produced at both 1:2,500 and 1:1,250 scales.

Map Name(s) and Date(s)

SK8883	1994	1:2,500
SK8882	1994	1:2,500

Historical Map - Segment G5

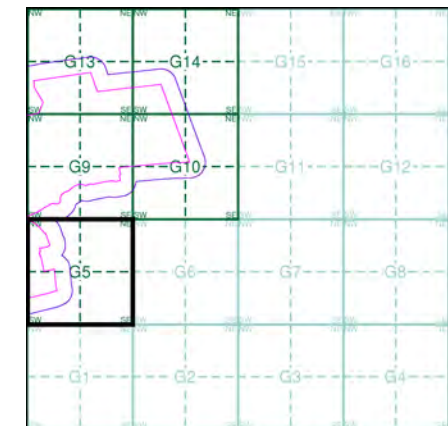

Order Details

Order Number: 297990210_1_1
 Customer Ref: 21-1088.04
 National Grid Reference: 488590, 383620
 Slice: G
 Site Area (Ha): 1120.8
 Search Buffer (m): 100

Site Details

Cottam



Historical Mapping Legends

Ordnance Survey County Series and Ordnance Survey Plan 1:2,500

Quarry **Gravel Pit** **Sand Pit**
Clay Pit **Shingle** **Refuse Heap**
Sloping Masonry **Flat Rock**
Marsh **Reeds** **Osiers**
Rough Pasture **Furze** **Wood**
Mixed Wood **Brushwood** **Orchard**
Fir **Ford** **Stepping Stones**
Ferry **Waterfall** **Lock**
Trig. Station **Altitude at Trig. Station**
B.M. 325.9 **Bench Mark** **Surface Level**
Arrow denotes flow of water **Antiquities (site of)**
Cutting **Embankment**
Railway crossing Road **Level Crossing** **Road crossing Railway**
Railway crossing River or Canal **Road over single stream** **Road over River or Canal**
County Boundary (Geographical)
County & Civil Parish Boundary
Administrative County & Civil Parish Boundary
County Borough Boundary (England)
Co. Boro. Bdy.
County Burgh Boundary (Scotland)
Boundary Post or Stone **Police Call Box**
B.R. **Bridle Road** **P** **Pump**
E.P. **Electricity Pylon** **S.P.** **Signal Post**
F.B. **Foot Bridge** **Sl.** **Sluice**
F.P. **Foot Path** **Sp.** **Spring**
G.P. **Guide Post or Board** **T.C.B.** **Telephone Call Box**
M.S. **Mile Stone** **Tr.** **Trough**
M.P. M.R. **Mooring Post or Ring** **W** **Well**

Ordnance Survey Plan, Additional SIMs and Supply of Unpublished Survey Information 1:2,500 and 1:1,250

Inactive Quarry, Chalk Pit or Clay Pit **Active Quarry, Chalk Pit or Clay Pit**
Rock **Boulders**
Cliff **Slopes** **Top**
Roofed Building **Glazed Roof Building**
Sloping Masonry **Archway**
Non-Coniferous Tree (surveyed) **Coniferous Tree (surveyed)**
Non-Coniferous Trees (not surveyed) **Coniferous Trees (not surveyed)**
Orchard Tree **Scrub** **Bracken**
Coppice, Osier **Reeds** **Marsh, Saltings**
Rough Grassland **Heath** **Culvert**
Direction of water flow **Bench Mark** **Antiquity (site of)**
Cave Entrance **Triangulation Station** **Electricity Pylon**
Electricity Transmission Line
County Boundary (Geographical)
County & Civil Parish Boundary
Civil Parish Boundary
Admin. County or County Bor. Boundary
London Borough Boundary
Symbol marking point where boundary mereing changes
BH **Beer House** **P** **Pillar, Pole or Post**
BP, BS **Boundary Post or Stone** **PO** **Post Office**
Cn, C **Capstan, Crane** **PC** **Public Convenience**
Chy **Chimney** **PH** **Public House**
D Fn **Drinking Fountain** **Pp** **Pump**
EI P **Electricity Pillar or Post** **SB, S Br** **Signal Box or Bridge**
FAP **Fire Alarm Pillar** **SP, SL** **Signal Post or Light**
FB **Foot Bridge** **Spr** **Spring**
GP **Guide Post** **Tk** **Tank or Track**
H **Hydrant or Hydraulic** **TCB** **Telephone Call Box**
LC **Level Crossing** **TCP** **Telephone Call Post**
MH **Manhole** **Tr** **Trough**
MP **Mile Post or Mooring Post** **Wr Pt, Wr T** **Water Point, Water Tap**
MS **Mile Stone** **W** **Well**
NTL **Normal Tidal Limit** **Wd Pp** **Wind Pump**

Large-Scale National Grid Data 1:2,500 and 1:1,250

Cliff **Slopes** **Top**
Rock **Rock (scattered)**
Boulders **Boulders (scattered)**
Positioned Boulder **Scree**
Non-Coniferous Tree (surveyed) **Coniferous Tree (surveyed)**
Non-Coniferous Trees (not surveyed) **Coniferous Trees (not surveyed)**
Orchard Tree **Scrub** **Bracken**
Coppice, Osier **Reeds** **Marsh, Saltings**
Rough Grassland **Heath** **Culvert**
Direction of water flow **Triangulation Station** **Antiquity (site of)**
Electricity Transmission Line **Electricity Pylon**
B.M. 231.60m **Bench Mark** **Buildings with Building Seed**
Roofed Building **Glazed Roof Building**
Civil parish/community boundary
District boundary
County boundary
Boundary post/stone
Boundary mereing symbol (note: these always appear in opposed pairs or groups of three)
Bks **Barracks** **P** **Pillar, Pole or Post**
Bty **Battery** **PO** **Post Office**
Cemy **Cemetery** **PC** **Public Convenience**
Chy **Chimney** **Pp** **Pump**
Cis **Cistern** **Ppg Sta** **Pumping Station**
Dismtd Rly **Dismantled Railway** **PW** **Place of Worship**
EI Gen Sta **Electricity Generating Station** **Sewage Ppg Sta** **Sewage Pumping Station**
EI P **Electricity Pole, Pillar** **SB, S Br** **Signal Box or Bridge**
EI Sub Sta **Electricity Sub Station** **SP, SL** **Signal Post or Light**
FB **Filter Bed** **Spr** **Spring**
Fn / D Fn **Fountain / Drinking Ftn.** **Tk** **Tank or Track**
Gas Gov **Gas Valve Compound** **Tr** **Trough**
GVC **Gas Governor** **Wd Pp** **Wind Pump**
GP **Guide Post** **Wr Pt, Wr T** **Water Point, Water Tap**
MH **Manhole** **Wks** **Works (building or area)**
MP, MS **Mile Post or Mile Stone** **W** **Well**



Historical Mapping & Photography included:

Mapping Type	Scale	Date	Pg
Lincolnshire	1:2,500	1886	2
Lincolnshire	1:2,500	1906	3
Ordnance Survey Plan	1:2,500	1975	4
Large-Scale National Grid Data	1:2,500	1994	5

Historical Map - Segment G9

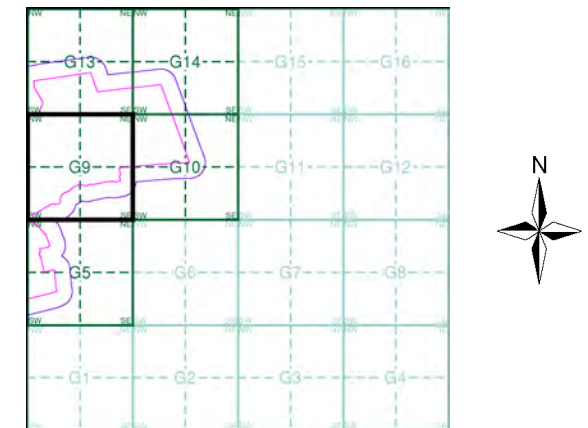

Order Details

Order Number: 297990210_1_1
 Customer Ref: 21-1088.04
 National Grid Reference: 488590, 383620
 Slice: G
 Site Area (Ha): 1120.8
 Search Buffer (m): 100

Site Details

Cottam



Tel: [Redacted]
 Fax: [Redacted]
 Web: [Redacted]

Lincolnshire
Published 1886

Source map scale - 1:2,500

The historical maps shown were reproduced from maps predominantly held at the scale adopted for England, Wales and Scotland in the 1840's. In 1854 the 1:2,500 scale was adopted for mapping urban areas and by 1896 it covered the whole of what were considered to be the cultivated parts of Great Britain. The published date given below is often some years later than the surveyed date. Before 1938, all OS maps were based on the Cassini Projection, with independent surveys of a single county or group of counties, giving rise to significant inaccuracies in outlying areas.

Map Name(s) and Date(s)

051_07
1886
1:2,500
051_11
1886
1:2,500

Historical Map - Segment G9

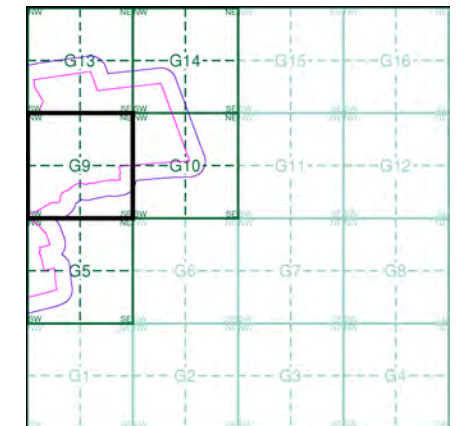

Order Details

Order Number: 297990210_1_1
 Customer Ref: 21-1088.04
 National Grid Reference: 488590, 383620
 Slice: G
 Site Area (Ha): 1120.8
 Search Buffer (m): 100

Site Details

Cottam

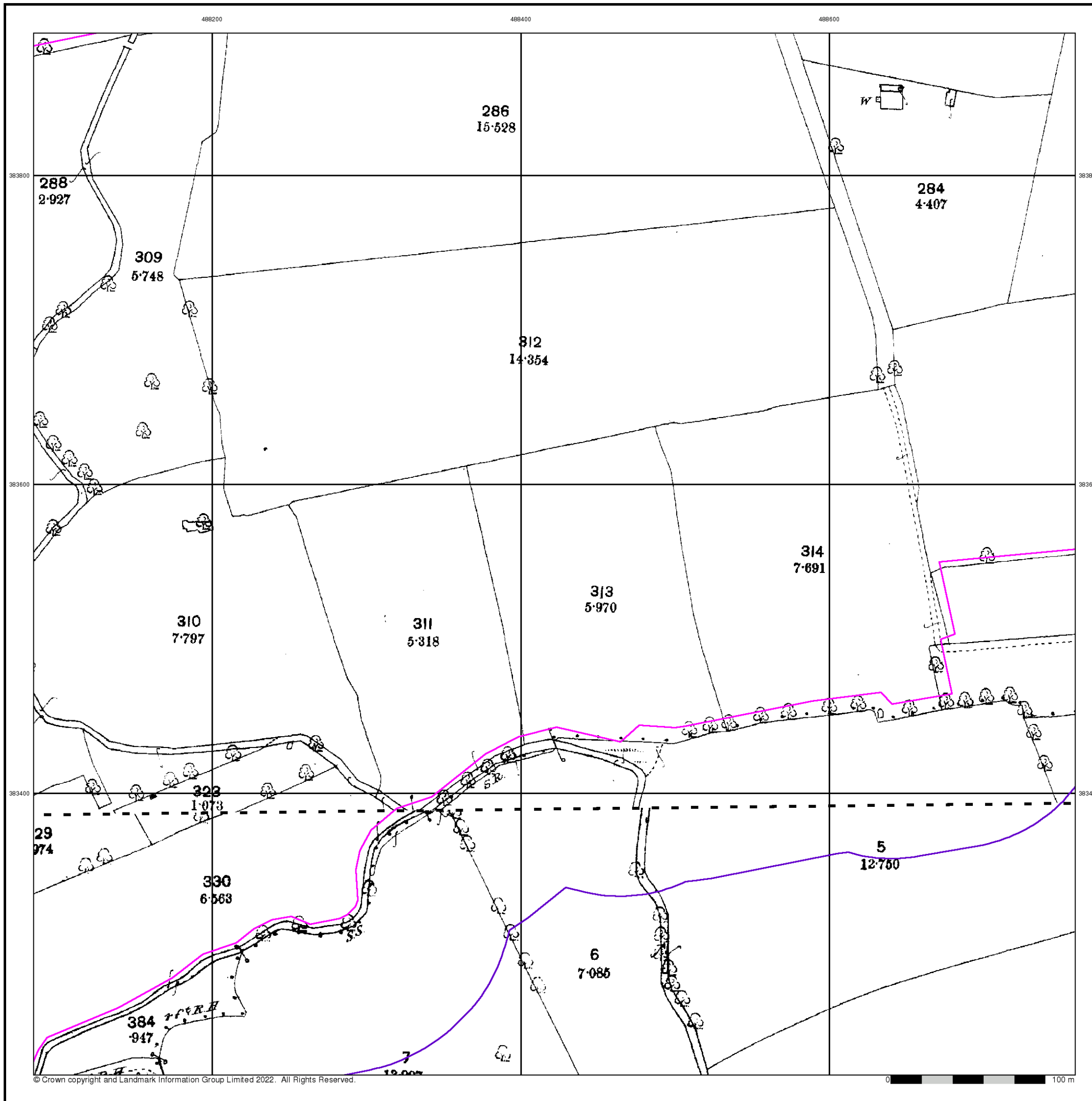

Lincolnshire
Published 1906

Source map scale - 1:2,500

The historical maps shown were reproduced from maps predominantly held at the scale adopted for England, Wales and Scotland in the 1840's. In 1854 the 1:2,500 scale was adopted for mapping urban areas and by 1896 it covered the whole of what were considered to be the cultivated parts of Great Britain. The published date given below is often some years later than the surveyed date. Before 1938, all OS maps were based on the Cassini Projection, with independent surveys of a single county or group of counties, giving rise to significant inaccuracies in outlying areas.

Map Name(s) and Date(s)

051_07
1906
1:2,500
051_11
1906
1:2,500

Historical Map - Segment G9

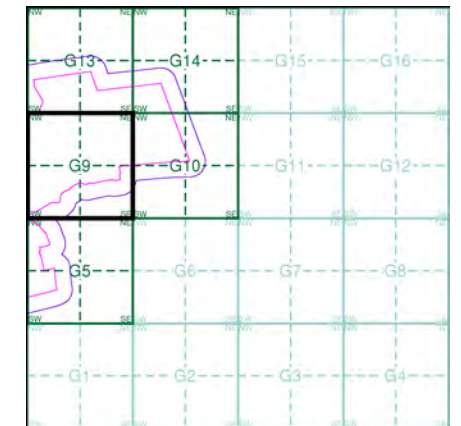

Order Details

Order Number: 297990210_1_1
 Customer Ref: 21-1088.04
 National Grid Reference: 488590, 383620
 Slice: G
 Site Area (Ha): 1120.8
 Search Buffer (m): 100

Site Details

Cottam

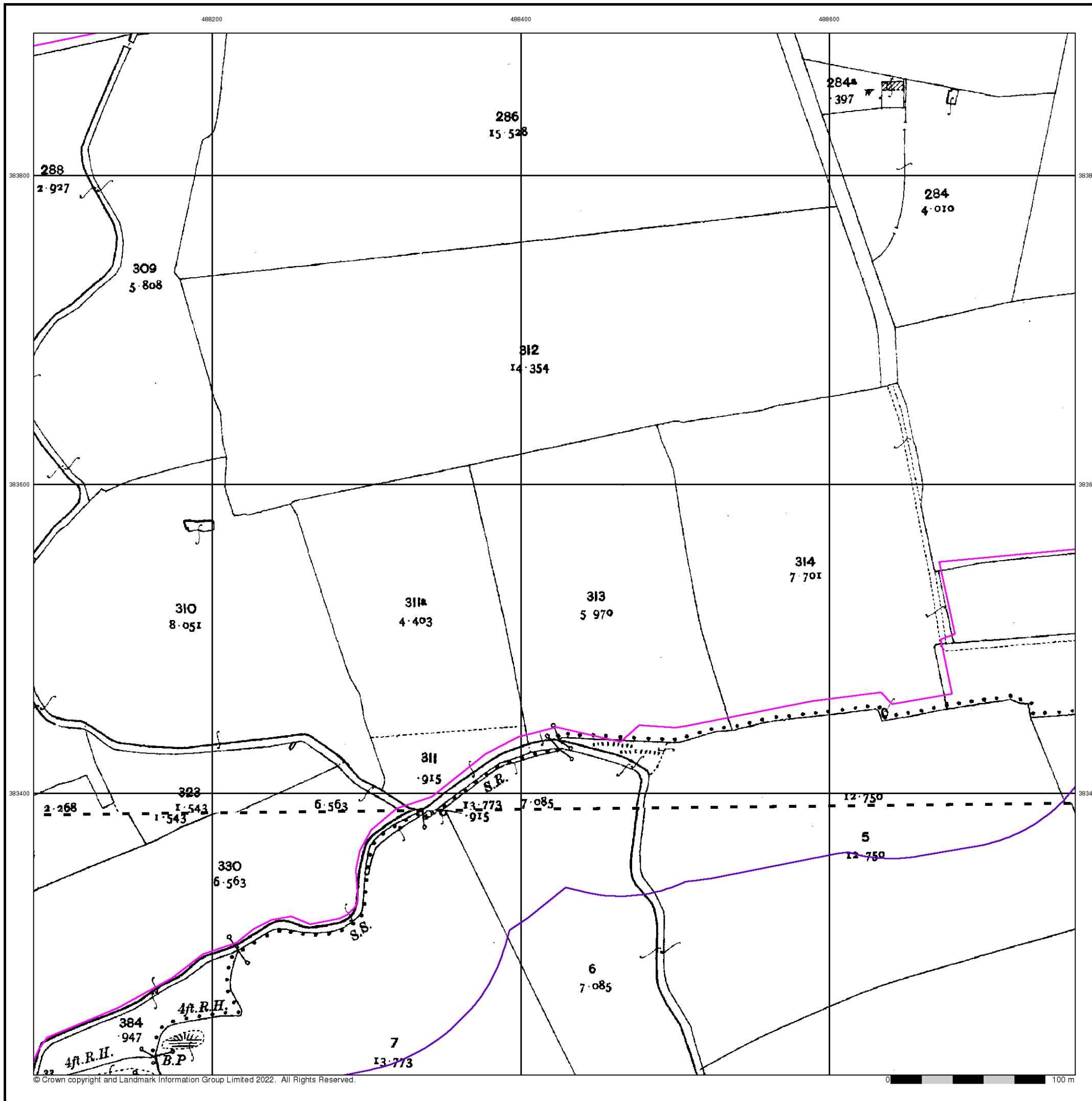

Large-Scale National Grid Data

Published 1994

Source map scale - 1:2,500

'Large Scale National Grid Data' superseded SIM cards (Ordnance Survey's 'Survey of Information on Microfilm') in 1992, and continued to be produced until 1999. These maps were the fore-runners of digital mapping and so provide detailed information on houses and roads, but tend to show less topographic features such as vegetation. These maps were produced at both 1:2,500 and 1:1,250 scales.

Map Name(s) and Date(s)

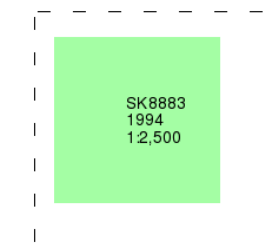

Historical Map - Segment G9

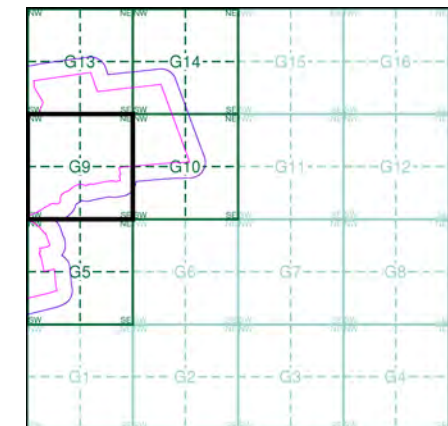

Order Details

Order Number: 297990210_1_1
 Customer Ref: 21-1088.04
 National Grid Reference: 488590, 383620
 Slice: G
 Site Area (Ha): 1120.8
 Search Buffer (m): 100

Site Details

Cottam

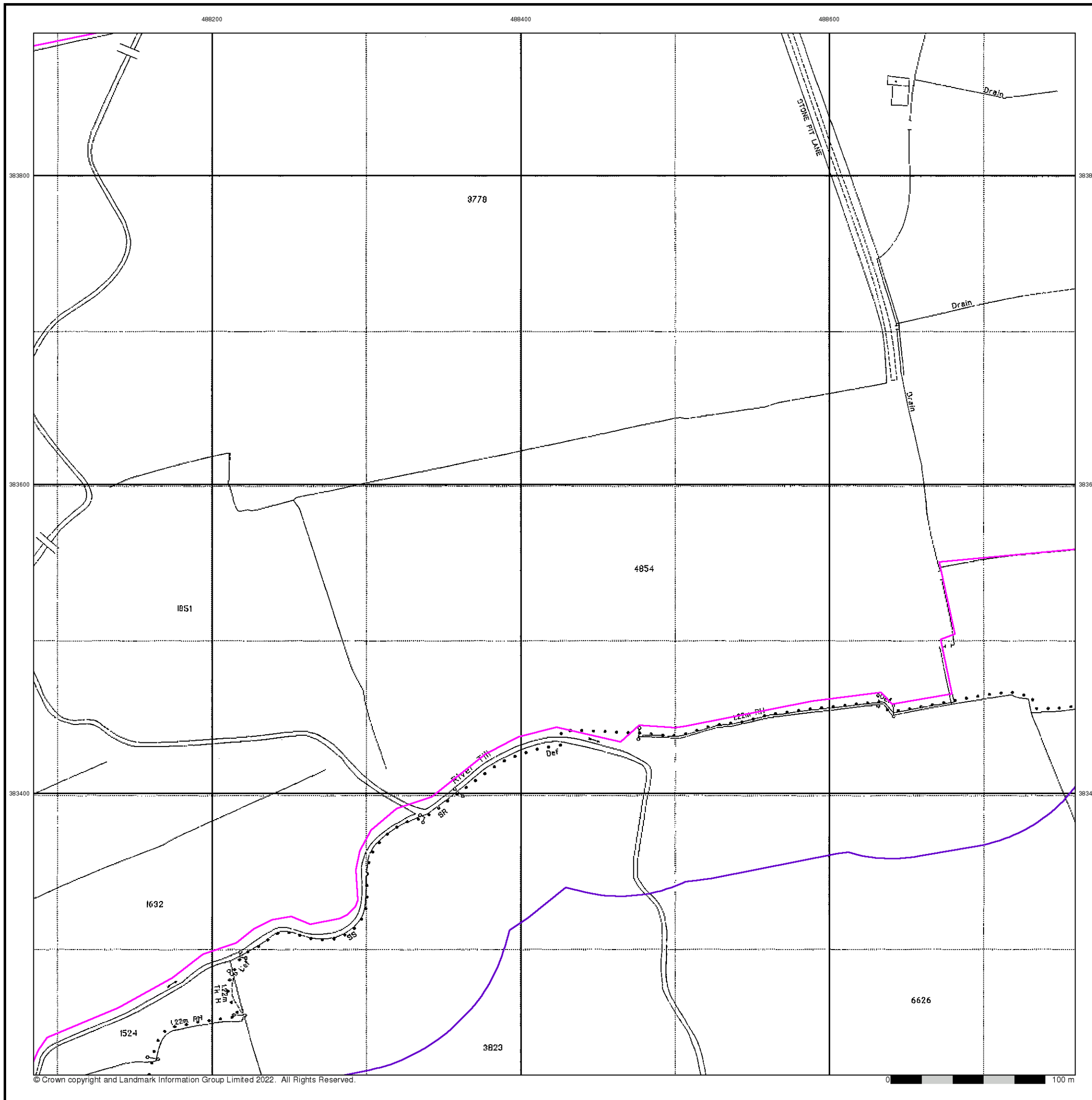

Historical Mapping Legends

Ordnance Survey County Series and Ordnance Survey Plan 1:2,500

Quarry **Gravel Pit** **Sand Pit**
Clay Pit **Shingle** **Refuse Heap**
Sloping Masonry **Flat Rock**
Marsh **Reeds** **Osiers**
Rough Pasture **Furze** **Wood**
Mixed Wood **Brushwood** **Orchard**
Fir **Ford** **Stepping Stones**
Ferry **Waterfall** **Lock**
Trig. Station 507 **Altitude at Trig. Station**
B.M. 325.9 **Bench Mark** 342 **Surface Level**
Arrow denotes flow of water **Antiquities (site of)**
Cutting **Embankment**
Railway crossing Road **Level Crossing** **Road crossing Railway**
Railway crossing River or Canal **Road over single stream** **Road over River or Canal**
County Boundary (Geographical)
County & Civil Parish Boundary
Administrative County & Civil Parish Boundary
County Borough Boundary (England)
Co. Boro. Bdy.
County Burgh Boundary (Scotland)
Co. Burgh Bdy.
BP BS **Boundary Post or Stone** **P.C.B** **Police Call Box**
B.R. **Bridle Road** **P** **Pump**
E.P **Electricity Pylon** **S.P** **Signal Post**
F.B. **Foot Bridge** **SL** **Sluice**
F.P. **Foot Path** **Sp.** **Spring**
G.P **Guide Post or Board** **T.C.B** **Telephone Call Box**
M.S **Mile Stone** **Tr.** **Trough**
M.P M.R **Mooring Post or Ring** **W** **Well**

Ordnance Survey Plan, Additional SIMs and Supply of Unpublished Survey Information 1:2,500 and 1:1,250

Inactive Quarry, Chalk Pit or Clay Pit **Active Quarry, Chalk Pit or Clay Pit**
Rock **Boulders**
Cliff **Slopes** **Top**
Roofed Building **Glazed Roof Building**
Sloping Masonry **Archway**
Non-Coniferous Tree (surveyed) **Coniferous Tree (surveyed)**
Non-Coniferous Trees (not surveyed) **Coniferous Trees (not surveyed)**
Orchard Tree **Scrub** **Bracken**
Coppice, Osier **Reeds** **Marsh, Saltings**
Rough Grassland **Heath** **Culvert**
Direction of water flow **Bench Mark** **Antiquity (site of)**
Cave Entrance **Triangulation Station** **Electricity Pylon**
Electricity Transmission Line
County Boundary (Geographical)
County & Civil Parish Boundary
Civil Parish Boundary
Admin. County or County Bor. Boundary
London Borough Boundary
Symbol marking point where boundary mereing changes
BH **Beer House** **P** **Pillar, Pole or Post**
BP, BS **Boundary Post or Stone** **PO** **Post Office**
Cn, C **Capstan, Crane** **PC** **Public Convenience**
Chy **Chimney** **PH** **Public House**
D Fn **Drinking Fountain** **Pp** **Pump**
EI P **Electricity Pillar or Post** **SB, S Br** **Signal Box or Bridge**
FAP **Fire Alarm Pillar** **SP, SL** **Signal Post or Light**
FB **Foot Bridge** **Spr** **Spring**
GP **Guide Post** **Tk** **Tank or Track**
H **Hydrant or Hydraulic** **TCB** **Telephone Call Box**
LC **Level Crossing** **TCP** **Telephone Call Post**
MH **Manhole** **Tr** **Trough**
MP **Mile Post or Mooring Post** **Wr Pt, Wr T** **Water Point, Water Tap**
MS **Mile Stone** **W** **Well**
NTL **Normal Tidal Limit** **Wd Pp** **Wind Pump**

Large-Scale National Grid Data 1:2,500 and 1:1,250

Cliff **Slopes** **Top**
Rock **Rock (scattered)**
Boulders **Boulders (scattered)**
Positioned Boulder **Scree**
Non-Coniferous Tree (surveyed) **Coniferous Tree (surveyed)**
Non-Coniferous Trees (not surveyed) **Coniferous Trees (not surveyed)**
Orchard Tree **Scrub** **Bracken**
Coppice, Osier **Reeds** **Marsh, Saltings**
Rough Grassland **Heath** **Culvert**
Direction of water flow **Triangulation Station** **Antiquity (site of)**
Electricity Transmission Line **Electricity Pylon**
B.M. 231.60m **Bench Mark** **Buildings with Building Seed**
Roofed Building **Glazed Roof Building**
Civil parish/community boundary
District boundary
County boundary
Boundary post/stone
Boundary mereing symbol (note: these always appear in opposed pairs or groups of three)
Bks **Barracks** **P** **Pillar, Pole or Post**
Bty **Battery** **PO** **Post Office**
Cemy **Cemetery** **PC** **Public Convenience**
Chy **Chimney** **Pp** **Pump**
Cis **Cistern** **Ppg Sta** **Pumping Station**
Dismtd Rly **Dismantled Railway** **PW** **Place of Worship**
EI Gen Sta **Electricity Generating Station** **Sewage Ppg Sta** **Sewage Pumping Station**
EI P **Electricity Pole, Pillar** **SB, S Br** **Signal Box or Bridge**
EI Sub Sta **Electricity Sub Station** **SP, SL** **Signal Post or Light**
FB **Filter Bed** **Spr** **Spring**
Fn / D Fn **Fountain / Drinking Ftn.** **Tk** **Tank or Track**
Gas Gov **Gas Valve Compound** **Tr** **Trough**
GVC **Gas Governor** **Wd Pp** **Wind Pump**
GP **Guide Post** **Wr Pt, Wr T** **Water Point, Water Tap**
MH **Manhole** **Wks** **Works (building or area)**
MP, MS **Mile Post or Mile Stone** **W** **Well**



Historical Mapping & Photography included:

Mapping Type	Scale	Date	Pg
Lincolnshire	1:2,500	1886	2
Lincolnshire	1:2,500	1906	3
Ordnance Survey Plan	1:2,500	1975	4
Large-Scale National Grid Data	1:2,500	1994	5

Historical Map - Segment G10

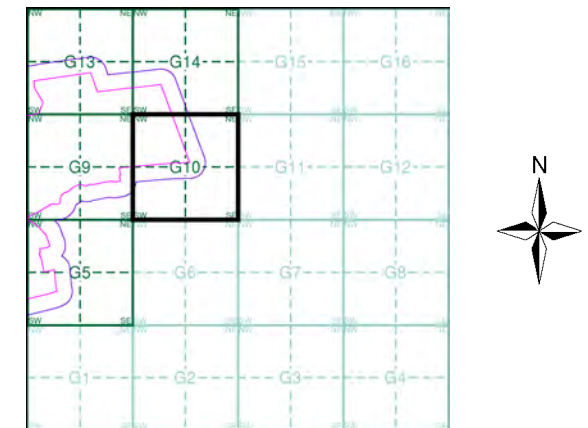

Order Details

Order Number: 297990210_1_1
Customer Ref: 21-1088.04
National Grid Reference: 488590, 383620
Slice: G
Site Area (Ha): 1120.8
Search Buffer (m): 100

Site Details

Cottam



Tel:
Fax:
Web:

Lincolnshire
Published 1886

Source map scale - 1:2,500

The historical maps shown were reproduced from maps predominantly held at the scale adopted for England, Wales and Scotland in the 1840's. In 1854 the 1:2,500 scale was adopted for mapping urban areas and by 1896 it covered the whole of what were considered to be the cultivated parts of Great Britain. The published date given below is often some years later than the surveyed date. Before 1938, all OS maps were based on the Cassini Projection, with independent surveys of a single county or group of counties, giving rise to significant inaccuracies in outlying areas.

Map Name(s) and Date(s)

051_07	1886	1:2,500
051_11	1886	1:2,500

Historical Map - Segment G10

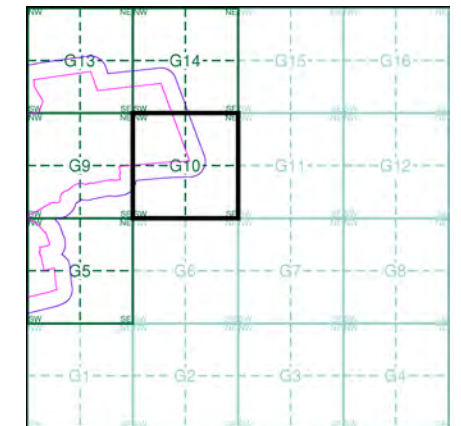

Order Details

Order Number: 297990210_1_1
 Customer Ref: 21-1088.04
 National Grid Reference: 488590, 383620
 Slice: G
 Site Area (Ha): 1120.8
 Search Buffer (m): 100

Site Details

Cottam

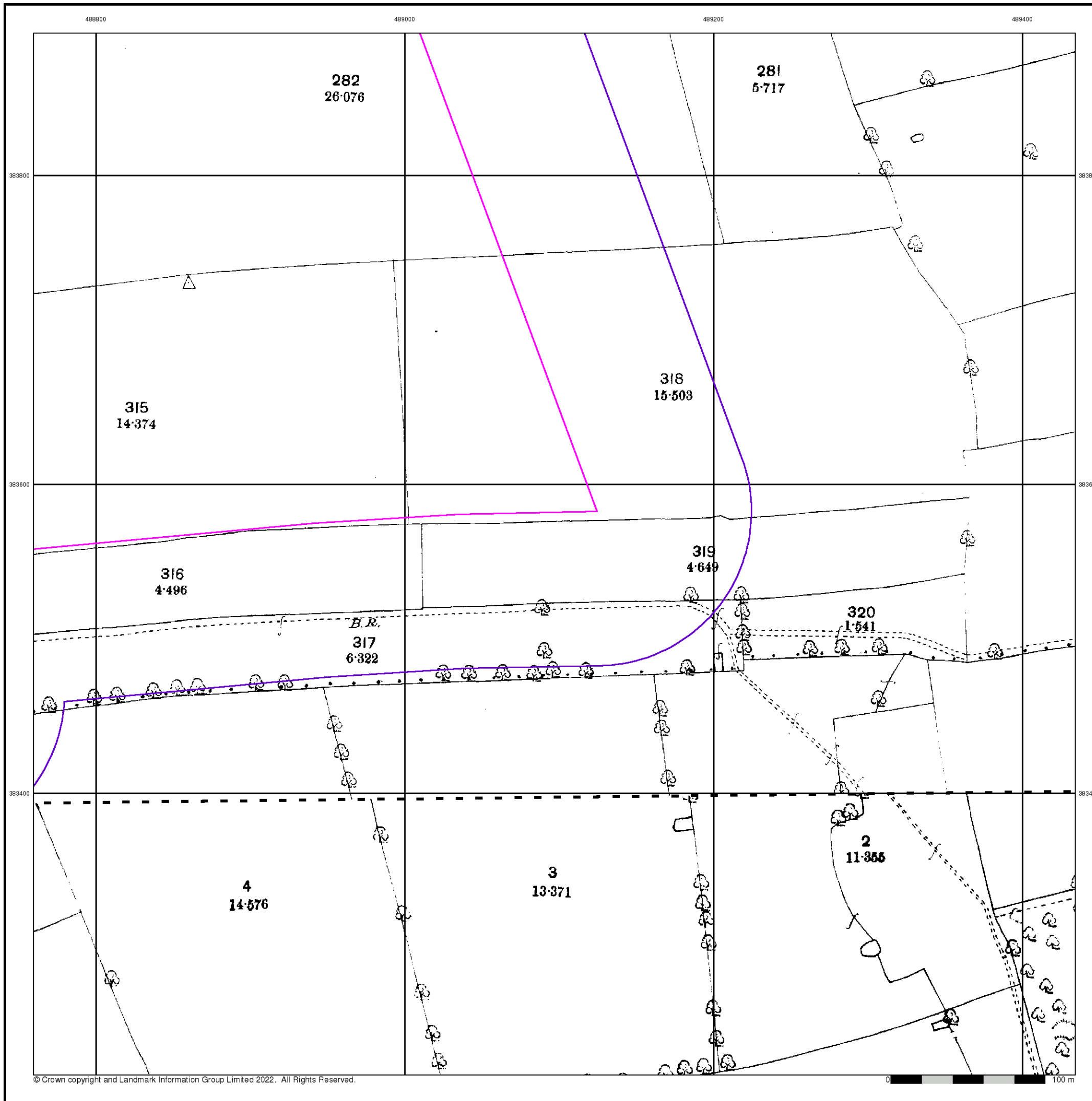

Lincolnshire
Published 1906

Source map scale - 1:2,500

The historical maps shown were reproduced from maps predominantly held at the scale adopted for England, Wales and Scotland in the 1840's. In 1854 the 1:2,500 scale was adopted for mapping urban areas and by 1896 it covered the whole of what were considered to be the cultivated parts of Great Britain. The published date given below is often some years later than the surveyed date. Before 1938, all OS maps were based on the Cassini Projection, with independent surveys of a single county or group of counties, giving rise to significant inaccuracies in outlying areas.

Map Name(s) and Date(s)

051_07	1906	1:2,500
051_11	1906	1:2,500

Historical Map - Segment G10

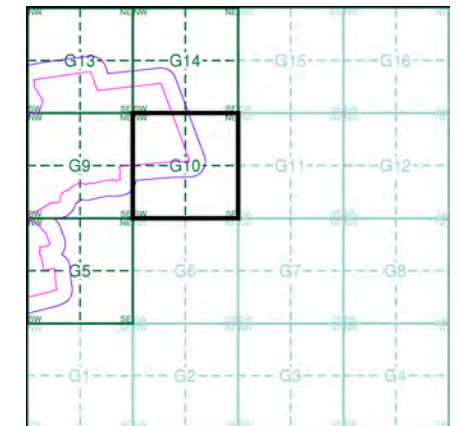

Order Details

Order Number: 297990210_1_1
 Customer Ref: 21-1088.04
 National Grid Reference: 488590, 383620
 Slice: G
 Site Area (Ha): 1120.8
 Search Buffer (m): 100

Site Details

Cottam

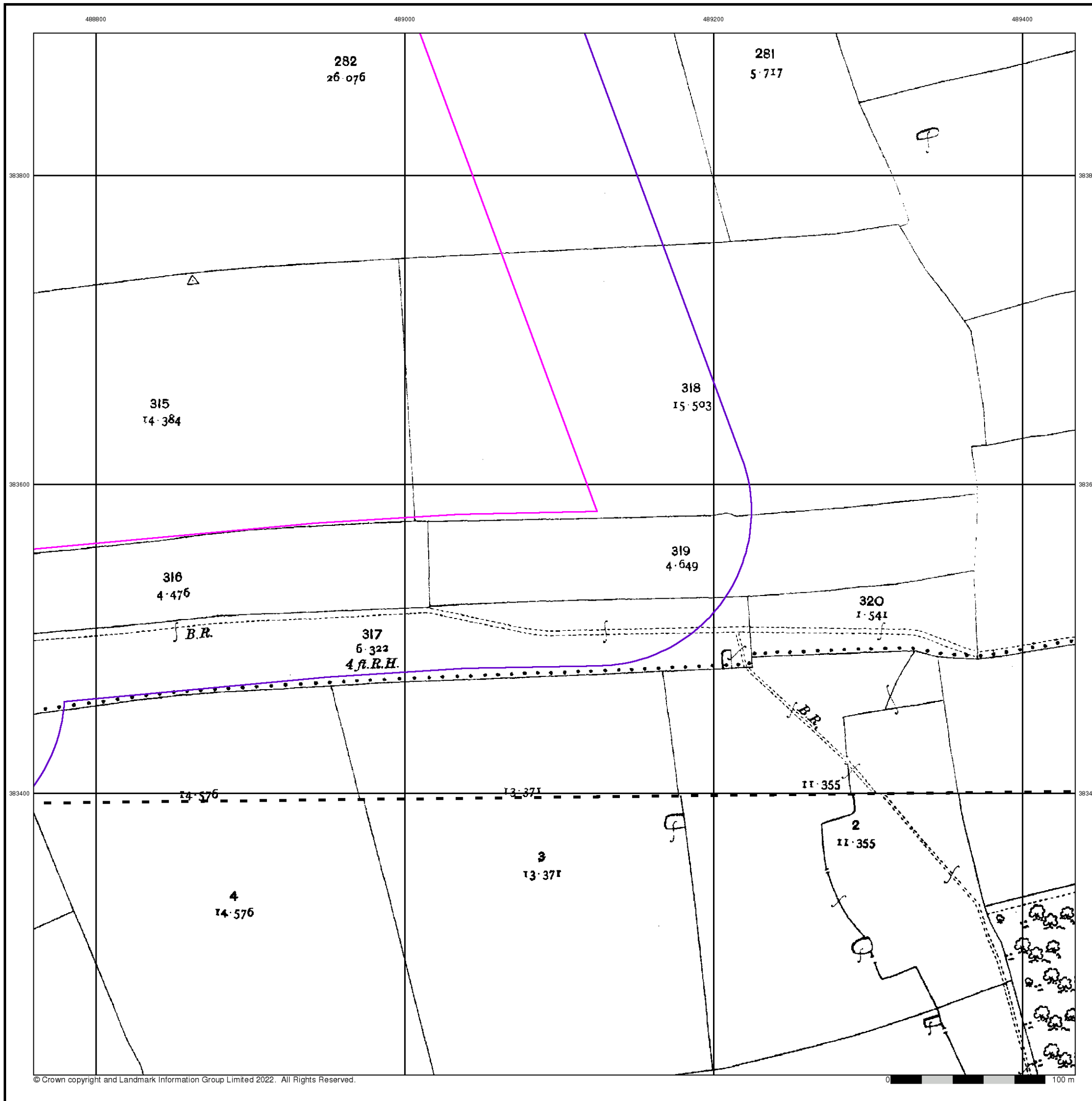

Ordnance Survey Plan

Published 1975

Source map scale - 1:2,500

The historical maps shown were reproduced from maps predominantly held at the scale adopted for England, Wales and Scotland in the 1840's. In 1854 the 1:2,500 scale was adopted for mapping urban areas and by 1896 it covered the whole of what were considered to be the cultivated parts of Great Britain. The published date given below is often some years later than the surveyed date. Before 1938, all OS maps were based on the Cassini Projection, with independent surveys of a single county or group of counties, giving rise to significant inaccuracies in outlying areas.

Map Name(s) and Date(s)

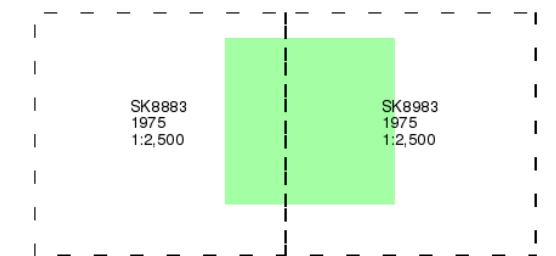

Historical Map - Segment G10

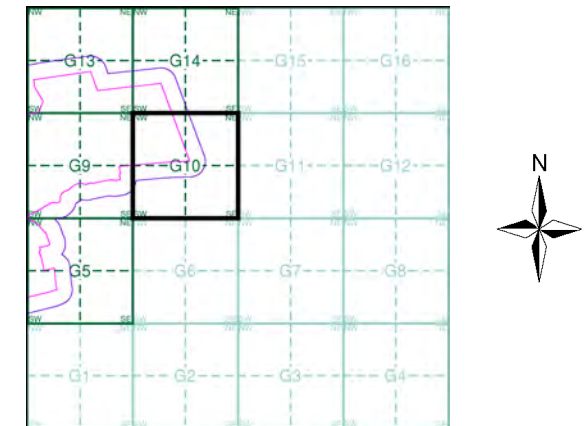

Order Details

Order Number: 297990210_1_1
 Customer Ref: 21-1088.04
 National Grid Reference: 488590, 383620
 Slice: G
 Site Area (Ha): 1120.8
 Search Buffer (m): 100

Site Details

Cottam

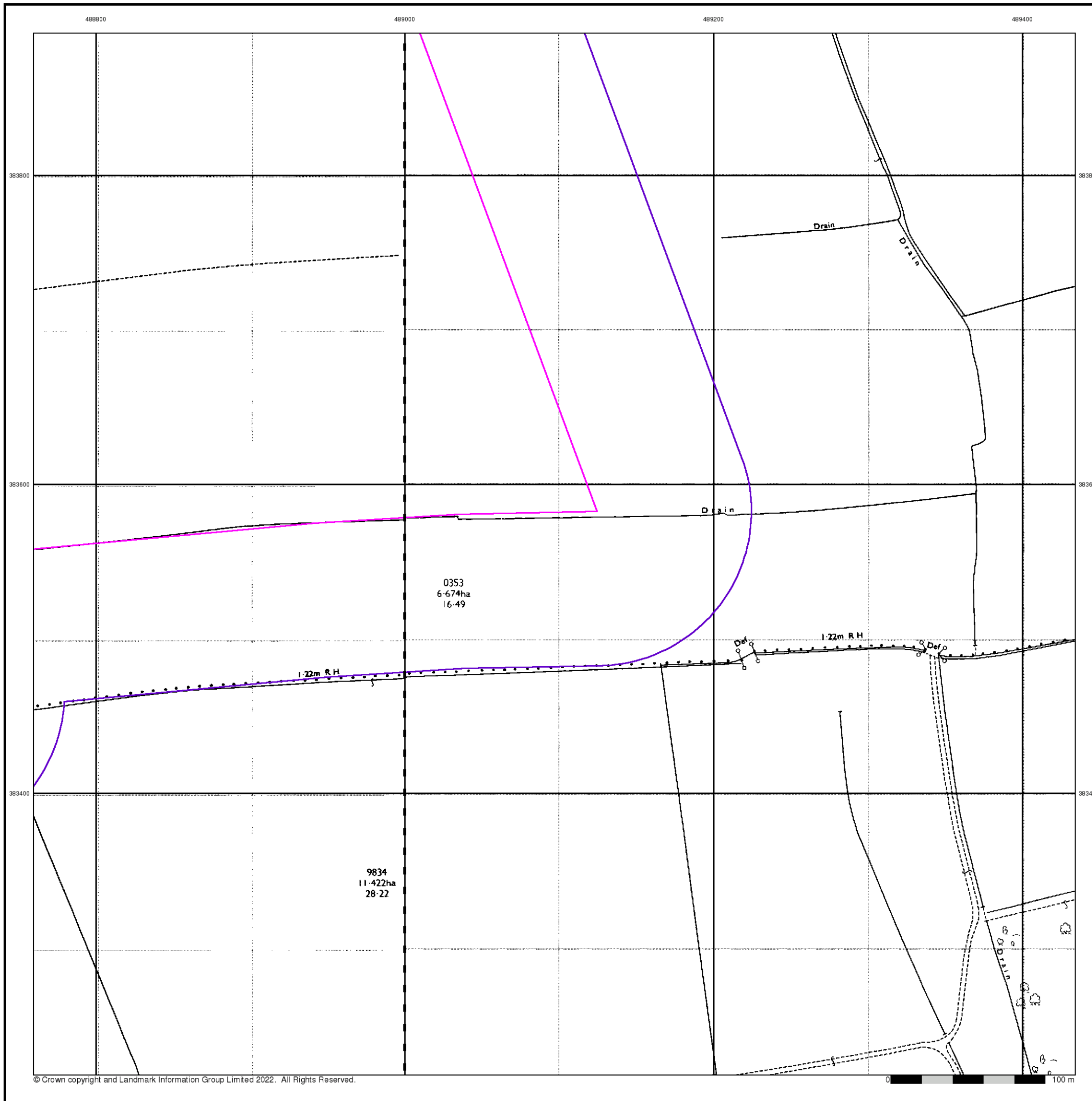

Large-Scale National Grid Data

Published 1994

Source map scale - 1:2,500

'Large Scale National Grid Data' superseded SIM cards (Ordnance Survey's 'Survey of Information on Microfilm') in 1992, and continued to be produced until 1999. These maps were the fore-runners of digital mapping and so provide detailed information on houses and roads, but tend to show less topographic features such as vegetation. These maps were produced at both 1:2,500 and 1:1,250 scales.

Map Name(s) and Date(s)

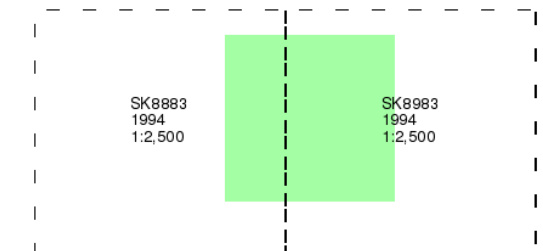

Historical Map - Segment G10

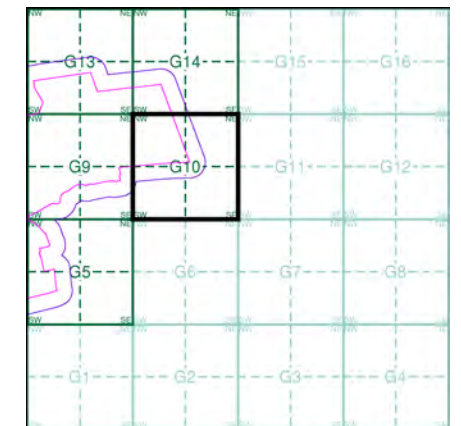

Order Details

Order Number: 297990210_1_1
 Customer Ref: 21-1088.04
 National Grid Reference: 488590, 383620
 Slice: G
 Site Area (Ha): 1120.8
 Search Buffer (m): 100

Site Details

Cottam

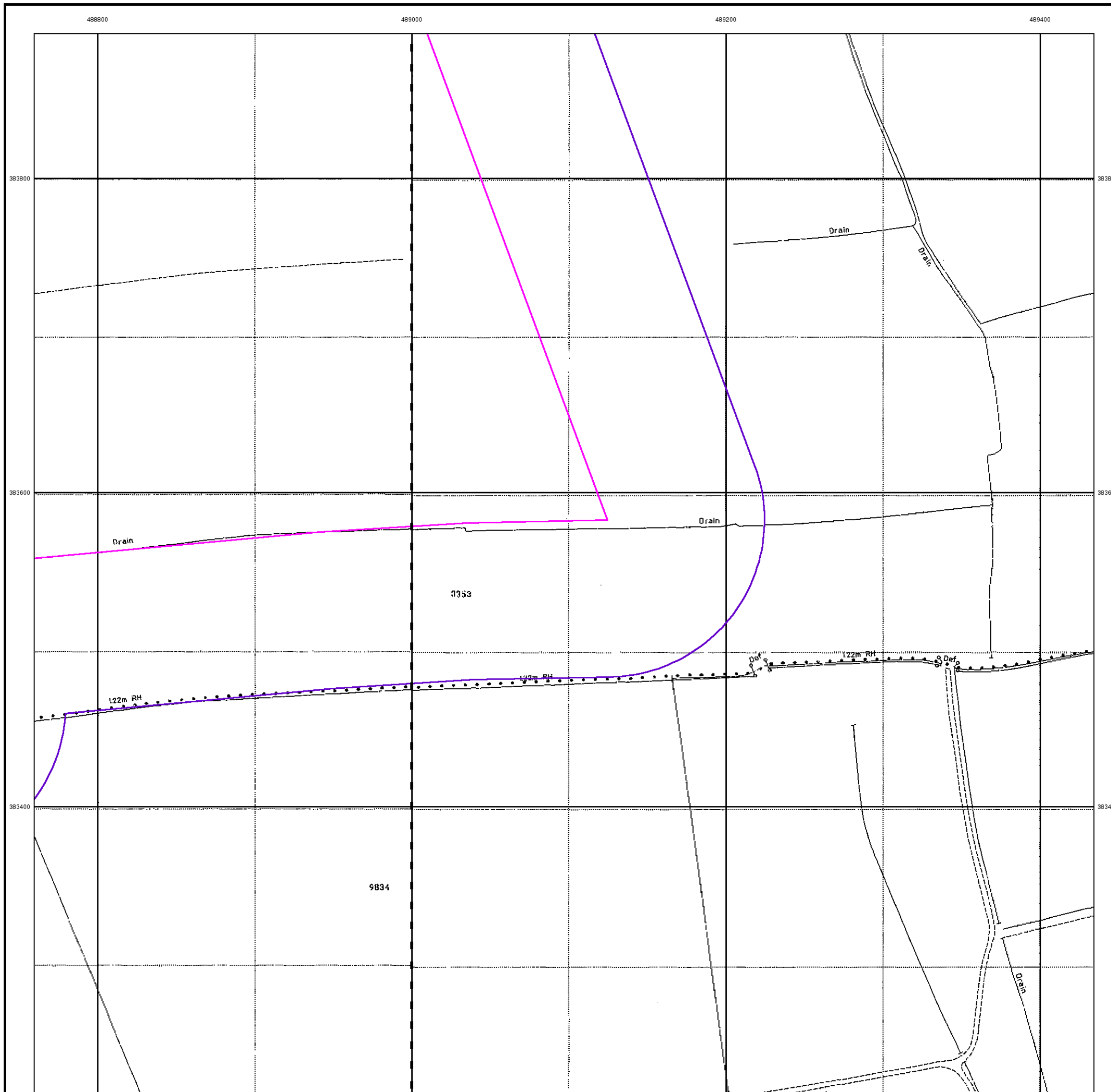

Historical Mapping Legends

Ordnance Survey County Series and Ordnance Survey Plan 1:2,500

Quarry **Gravel Pit** **Sand Pit**
Clay Pit **Shingle** **Refuse Heap**
Sloping Masonry **Flat Rock**
Marsh **Reeds** **Osiers**
Rough Pasture **Furze** **Wood**
Mixed Wood **Brushwood** **Orchard**
Fir **Ford** **Stepping Stones**
Ferry **Waterfall** **Lock**
Trig. Station **Altitude at Trig. Station**
B.M. 325.9 **Bench Mark** **Surface Level**
Arrow denotes flow of water **Antiquities (site of)**
Cutting **Embankment**
Railway crossing Road **Level Crossing** **Road crossing Railway**
Railway crossing River or Canal **Road over single stream** **Road over River or Canal**
County Boundary (Geographical)
County & Civil Parish Boundary
Administrative County & Civil Parish Boundary
County Borough Boundary (England)
Co. Boro. Bdy.
County Burgh Boundary (Scotland)
Boundary Post or Stone **Police Call Box**
B.R. **Bridle Road** **P** **Pump**
E.P. **Electricity Pylon** **S.P.** **Signal Post**
F.B. **Foot Bridge** **Sl.** **Sluice**
F.P. **Foot Path** **Sp.** **Spring**
G.P. **Guide Post or Board** **T.C.B.** **Telephone Call Box**
M.S. **Mile Stone** **Tr.** **Trough**
M.P. M.R. **Mooring Post or Ring** **W** **Well**

Ordnance Survey Plan, Additional SIMs and Supply of Unpublished Survey Information 1:2,500 and 1:1,250

Inactive Quarry, Chalk Pit or Clay Pit **Active Quarry, Chalk Pit or Clay Pit**
Rock **Boulders**
Cliff **Slopes** **Top**
Roofed Building **Glazed Roof Building**
Sloping Masonry **Archway**
Non-Coniferous Tree (surveyed) **Coniferous Tree (surveyed)**
Non-Coniferous Trees (not surveyed) **Coniferous Trees (not surveyed)**
Orchard Tree **Scrub** **Bracken**
Coppice, Osier **Reeds** **Marsh, Saltings**
Rough Grassland **Heath** **Culvert**
Direction of water flow **Bench Mark** **Antiquity (site of)**
Cave Entrance **Triangulation Station** **Electricity Pylon**
Electricity Transmission Line
County Boundary (Geographical)
County & Civil Parish Boundary
Civil Parish Boundary
Admin. County or County Bor. Boundary
London Borough Boundary
Symbol marking point where boundary mereing changes
Beer House **Pillar, Pole or Post**
Boundary Post or Stone **Post Office**
Capstan, Crane **Public Convenience**
Chimney **Public House**
Drinking Fountain **Pump**
Electricity Pillar or Post **Signal Box or Bridge**
Fire Alarm Pillar **Signal Post or Light**
Foot Bridge **Spring**
Guide Post **Tank or Track**
Hydrant or Hydraulic **Telephone Call Box**
Level Crossing **Telephone Call Post**
Manhole **Trough**
Mile Post or Mooring Post **Water Point, Water Tap**
Mile Stone **Well**
Normal Tidal Limit **Wind Pump**

Large-Scale National Grid Data 1:2,500 and 1:1,250

Cliff **Slopes** **Top**
Rock **Rock (scattered)**
Boulders **Boulders (scattered)**
Positioned Boulder **Scree**
Non-Coniferous Tree (surveyed) **Coniferous Tree (surveyed)**
Non-Coniferous Trees (not surveyed) **Coniferous Trees (not surveyed)**
Orchard Tree **Scrub** **Bracken**
Coppice, Osier **Reeds** **Marsh, Saltings**
Rough Grassland **Heath** **Culvert**
Direction of water flow **Triangulation Station** **Antiquity (site of)**
Electricity Transmission Line **Electricity Pylon**
Bench Mark **Buildings with Building Seed**
Roofed Building **Glazed Roof Building**
Civil parish/community boundary
District boundary
County boundary
Boundary post/stone
Boundary mereing symbol (note: these always appear in opposed pairs or groups of three)
Barracks **Pillar, Pole or Post**
Battery **Post Office**
Cemetery **Public Convenience**
Chimney **Pump**
Cistern **Pumping Station**
Dismtd Rly **Place of Worship**
Electricity Generating Station **Sewage Ppg Sta** **Sewage Pumping Station**
Electricity Pole, Pillar **Signal Box or Bridge**
Electricity Sub Station **Signal Post or Light**
Filter Bed **Spring**
Fountain / Drinking Ftn. **Tank or Track**
Gas Valve Compound **Trough**
Gas Governor **Wind Pump**
Guide Post **Water Point, Water Tap**
Manhole **Works (building or area)**
Mile Post or Mile Stone **Well**



Historical Mapping & Photography included:

Mapping Type	Scale	Date	Pg
Lincolnshire	1:2,500	1886	2
Lincolnshire	1:2,500	1906	3
Ordnance Survey Plan	1:2,500	1975	4
Large-Scale National Grid Data	1:2,500	1994	5

Historical Map - Segment G13

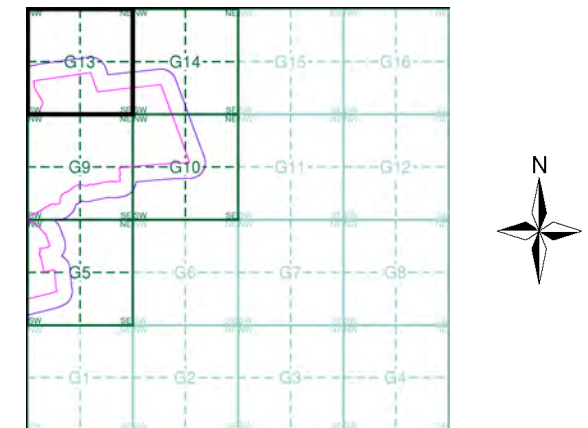

Order Details

Order Number: 297990210_1_1
 Customer Ref: 21-1088.04
 National Grid Reference: 488590, 383620
 Slice: G
 Site Area (Ha): 1120.8
 Search Buffer (m): 100

Site Details

Cottam



Tel:
Fax:
Web:

Lincolnshire
Published 1886

Source map scale - 1:2,500

The historical maps shown were reproduced from maps predominantly held at the scale adopted for England, Wales and Scotland in the 1840's. In 1854 the 1:2,500 scale was adopted for mapping urban areas and by 1896 it covered the whole of what were considered to be the cultivated parts of Great Britain. The published date given below is often some years later than the surveyed date. Before 1938, all OS maps were based on the Cassini Projection, with independent surveys of a single county or group of counties, giving rise to significant inaccuracies in outlying areas.

Map Name(s) and Date(s)

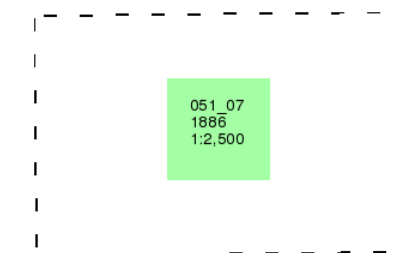

Historical Map - Segment G13

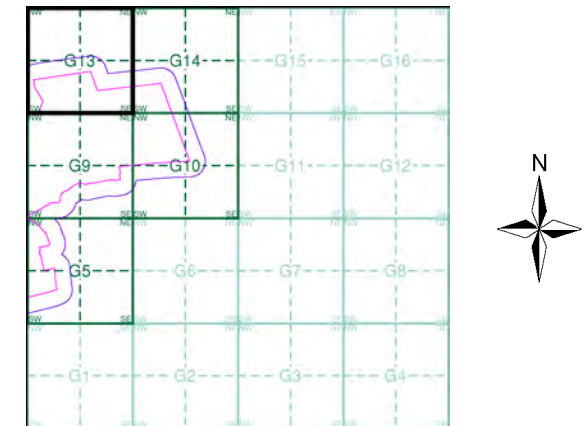

Order Details

Order Number: 297990210_1_1
 Customer Ref: 21-1088.04
 National Grid Reference: 488590, 383620
 Slice: G
 Site Area (Ha): 1120.8
 Search Buffer (m): 100

Site Details

Cottam

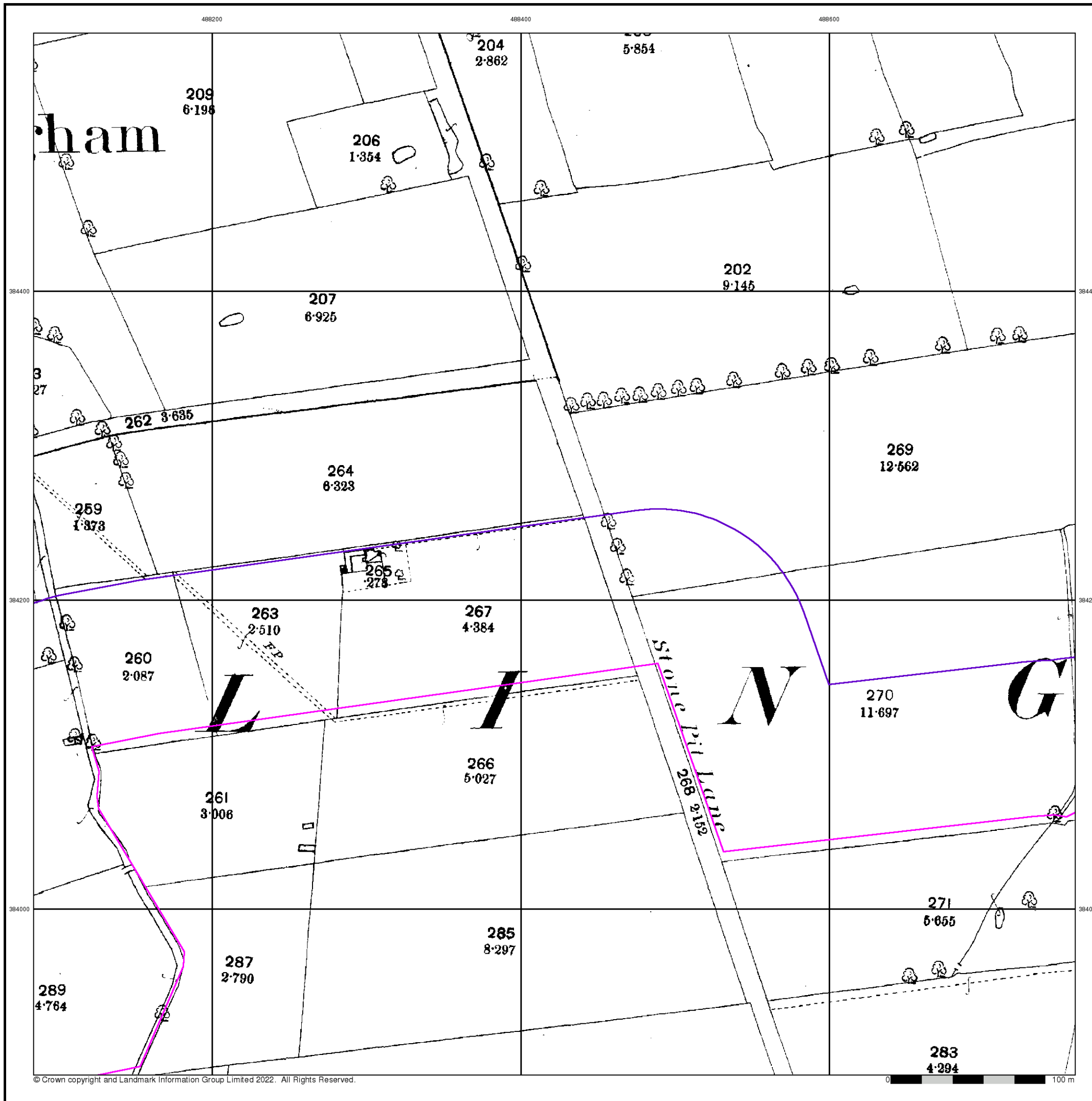

Lincolnshire

Published 1906

Source map scale - 1:2,500

The historical maps shown were reproduced from maps predominantly held at the scale adopted for England, Wales and Scotland in the 1840's. In 1854 the 1:2,500 scale was adopted for mapping urban areas and by 1896 it covered the whole of what were considered to be the cultivated parts of Great Britain. The published date given below is often some years later than the surveyed date. Before 1938, all OS maps were based on the Cassini Projection, with independent surveys of a single county or group of counties, giving rise to significant inaccuracies in outlying areas.

Map Name(s) and Date(s)

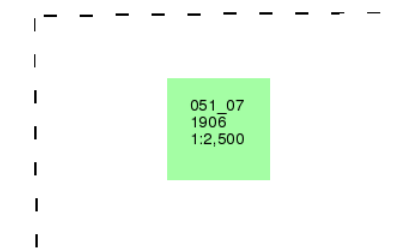

Historical Map - Segment G13

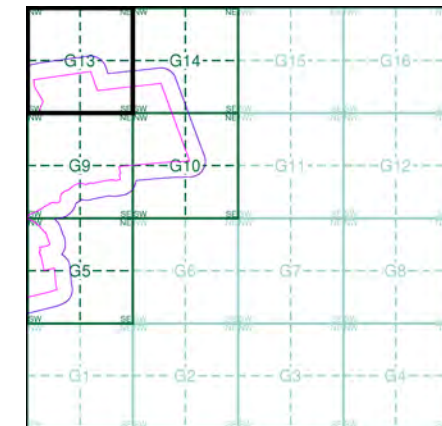

Order Details

Order Number: 297990210_1_1
 Customer Ref: 21-1088.04
 National Grid Reference: 488590, 383620
 Slice: G
 Site Area (Ha): 1120.8
 Search Buffer (m): 100

Site Details

Cottam

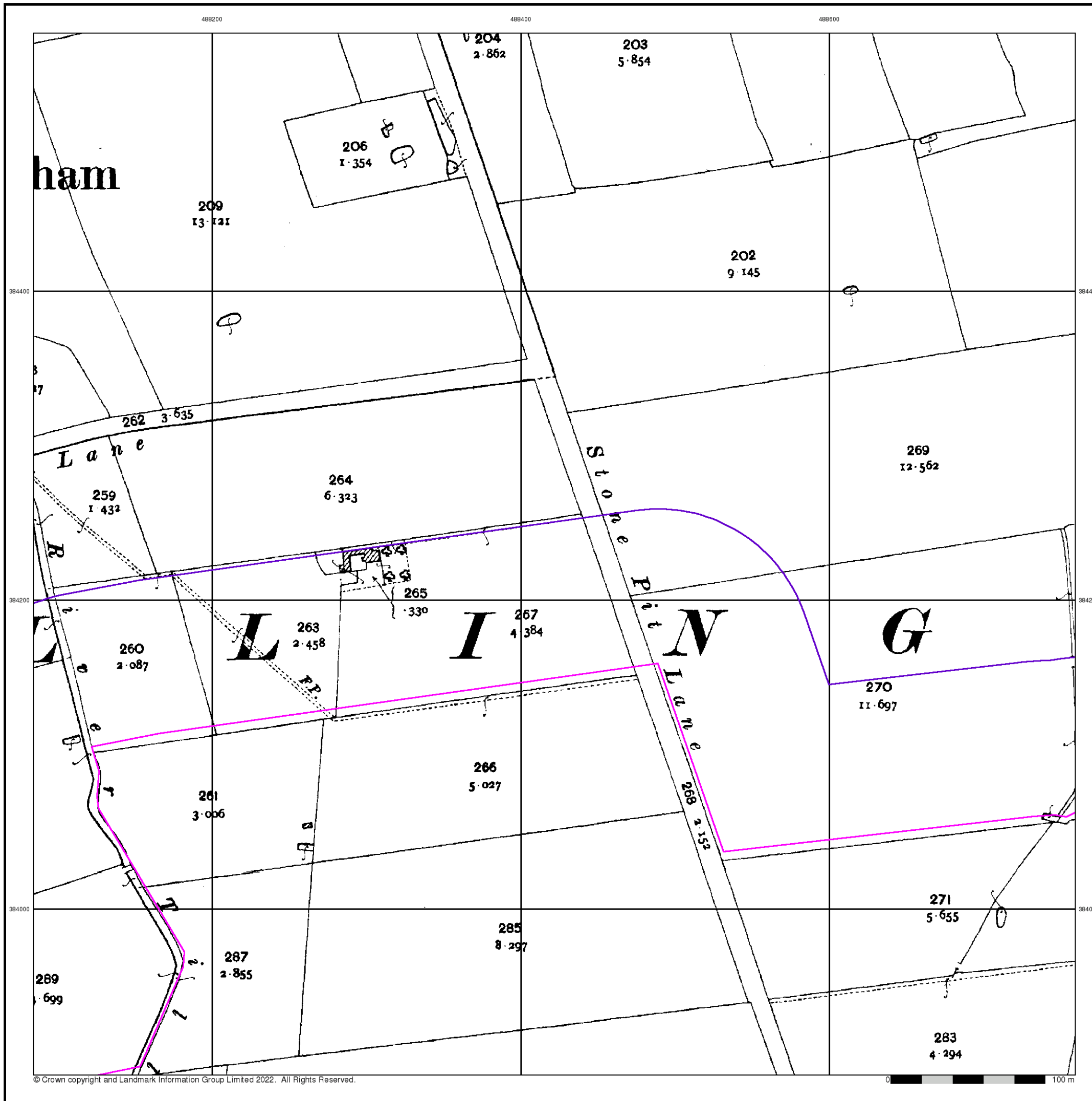

Ordnance Survey Plan

Published 1975

Source map scale - 1:2,500

The historical maps shown were reproduced from maps predominantly held at the scale adopted for England, Wales and Scotland in the 1840's. In 1854 the 1:2,500 scale was adopted for mapping urban areas and by 1896 it covered the whole of what were considered to be the cultivated parts of Great Britain. The published date given below is often some years later than the surveyed date. Before 1938, all OS maps were based on the Cassini Projection, with independent surveys of a single county or group of counties, giving rise to significant inaccuracies in outlying areas.

Map Name(s) and Date(s)

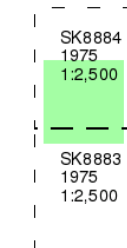

Historical Map - Segment G13

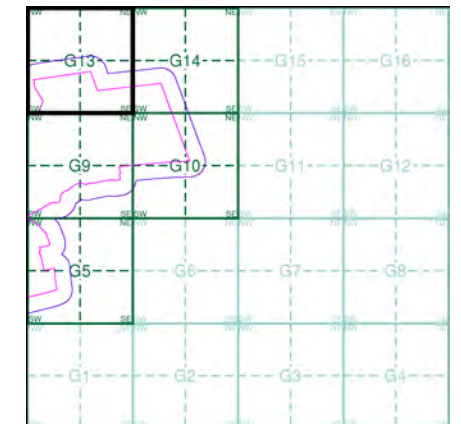

Order Details

Order Number: 297990210_1_1
 Customer Ref: 21-1088.04
 National Grid Reference: 488590, 383620
 Slice: G
 Site Area (Ha): 1120.8
 Search Buffer (m): 100

Site Details

Cottam

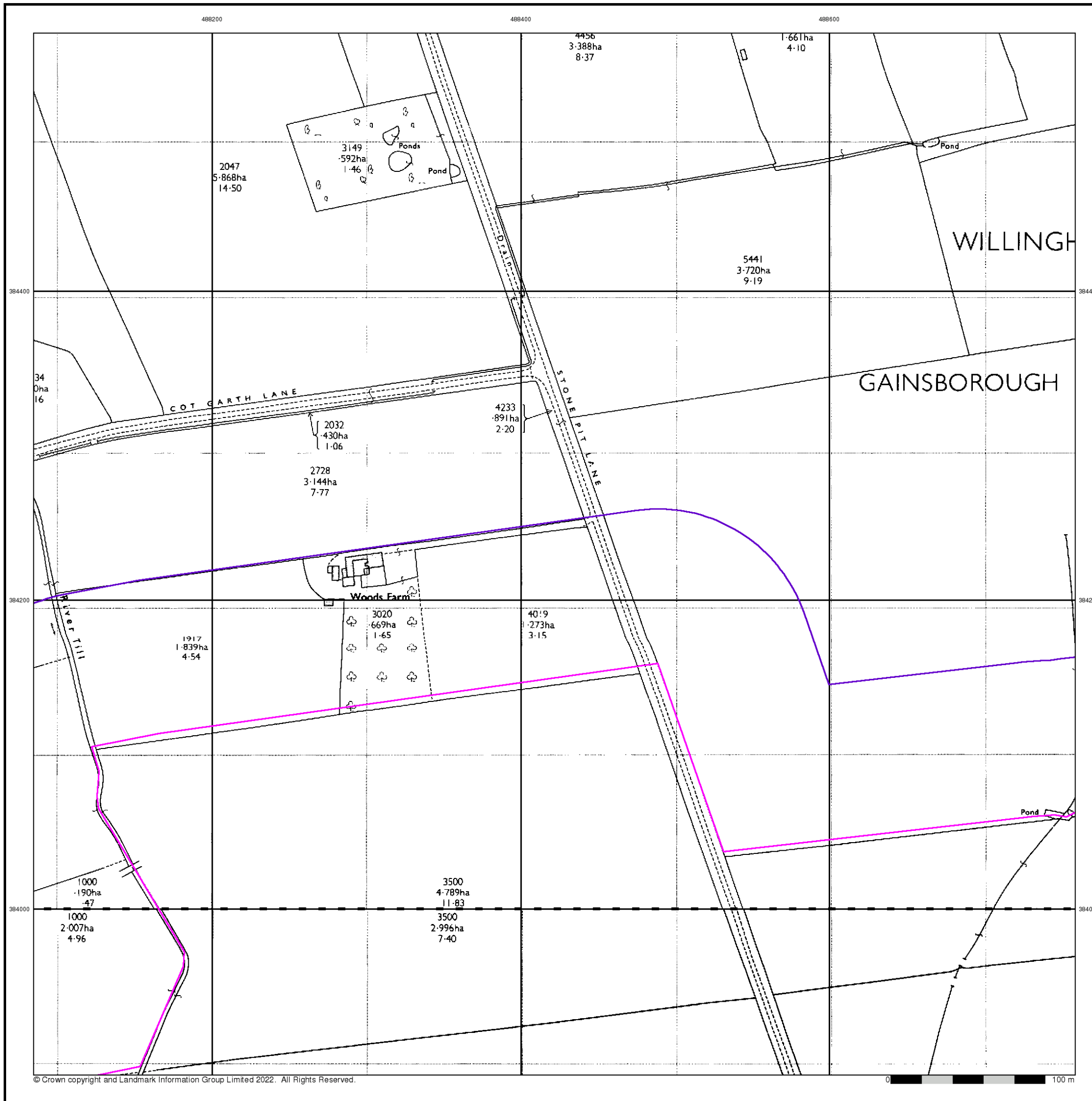

Large-Scale National Grid Data

Published 1994

Source map scale - 1:2,500

'Large Scale National Grid Data' superseded SIM cards (Ordnance Survey's 'Survey of Information on Microfilm') in 1992, and continued to be produced until 1999. These maps were the fore-runners of digital mapping and so provide detailed information on houses and roads, but tend to show less topographic features such as vegetation. These maps were produced at both 1:2,500 and 1:1,250 scales.

Map Name(s) and Date(s)

SK8884	1994	1:2,500
SK8883	1994	1:2,500

Historical Map - Segment G13

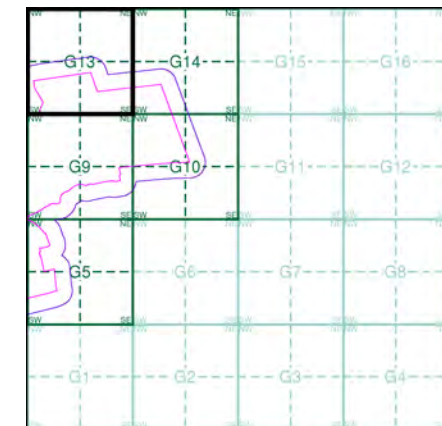

Order Details

Order Number: 297990210_1_1
 Customer Ref: 21-1088.04
 National Grid Reference: 488590, 383620
 Slice: G
 Site Area (Ha): 1120.8
 Search Buffer (m): 100

Site Details

Cottam

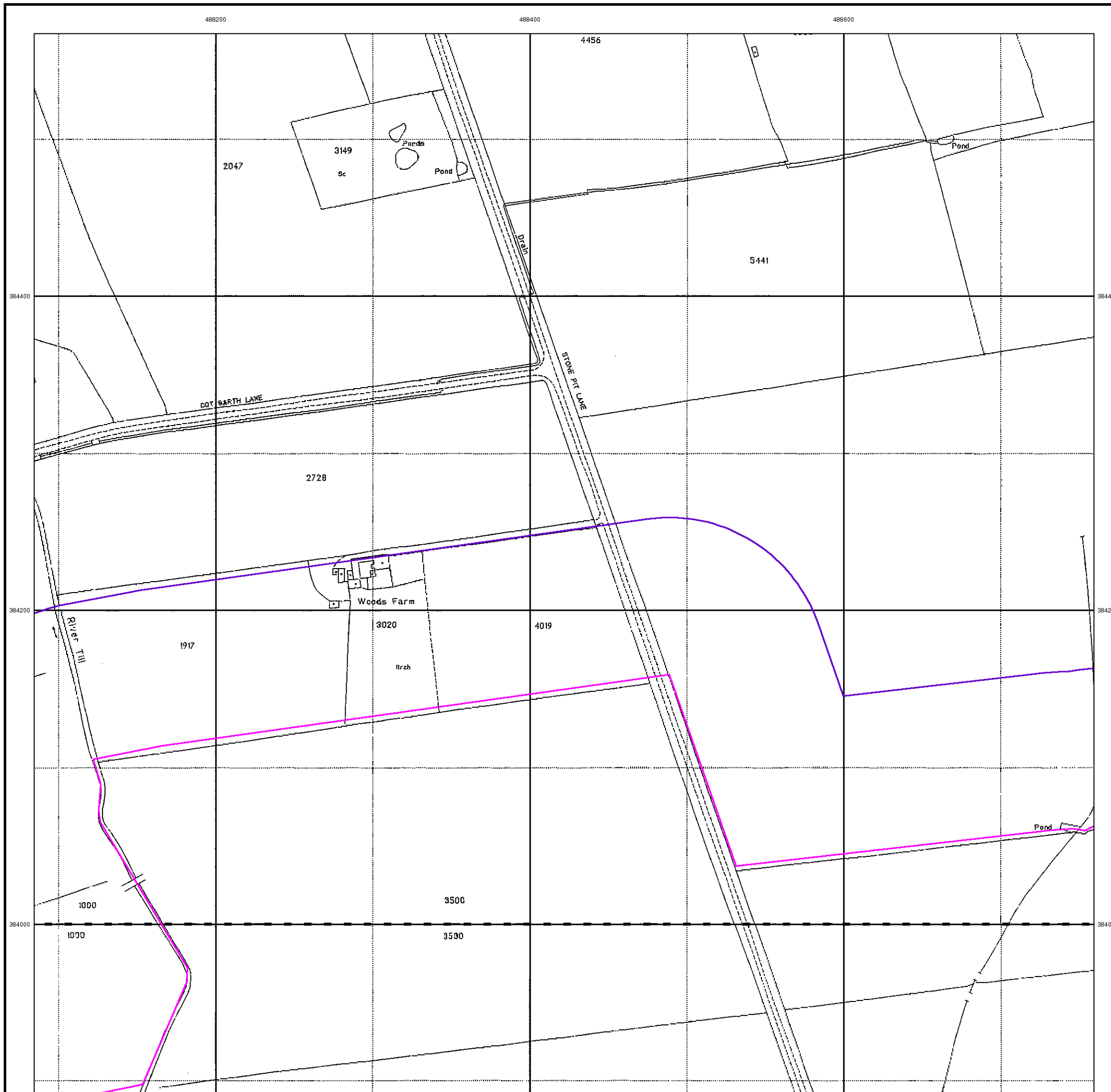

Historical Mapping Legends

Ordnance Survey County Series and Ordnance Survey Plan 1:2,500

Quarry **Gravel Pit** **Sand Pit**
Clay Pit **Shingle** **Refuse Heap**
Sloping Masonry **Flat Rock**
Marsh **Reeds** **Osiers**
Rough Pasture **Furze** **Wood**
Mixed Wood **Brushwood** **Orchard**
Fir **Ford** **Stepping Stones**
Ferry **Waterfall** **Lock**
Trig. Station **Altitude at Trig. Station**
B.M. 325.9 **Bench Mark** **Surface Level**
Arrow denotes flow of water **Antiquities (site of)**
Cutting **Embankment**
Railway crossing Road **Level Crossing** **Road crossing Railway**
Railway crossing River or Canal **Road over single stream** **Road over River or Canal**
County Boundary (Geographical)
County & Civil Parish Boundary
Administrative County & Civil Parish Boundary
County Borough Boundary (England)
Co. Boro. Bdy.
County Burgh Boundary (Scotland)
Boundary Post or Stone **Police Call Box**
B.R. **Bridle Road** **P** **Pump**
E.P. **Electricity Pylon** **S.P.** **Signal Post**
F.B. **Foot Bridge** **Sl.** **Sluice**
F.P. **Foot Path** **Sp.** **Spring**
G.P. **Guide Post or Board** **T.C.B.** **Telephone Call Box**
M.S. **Mile Stone** **Tr.** **Trough**
M.P. M.R. **Mooring Post or Ring** **W** **Well**

Ordnance Survey Plan, Additional SIMs and Supply of Unpublished Survey Information 1:2,500 and 1:1,250

Inactive Quarry, Chalk Pit or Clay Pit **Active Quarry, Chalk Pit or Clay Pit**
Rock **Boulders**
Cliff **Slopes** **Top**
Roofed Building **Glazed Roof Building**
Sloping Masonry **Archway**
Non-Coniferous Tree (surveyed) **Coniferous Tree (surveyed)**
Non-Coniferous Trees (not surveyed) **Coniferous Trees (not surveyed)**
Orchard Tree **Scrub** **Bracken**
Coppice, Osier **Reeds** **Marsh, Saltings**
Rough Grassland **Heath** **Culvert**
Direction of water flow **Bench Mark** **Antiquity (site of)**
Cave Entrance **Triangulation Station** **Electricity Pylon**
Electricity Transmission Line
County Boundary (Geographical)
County & Civil Parish Boundary
Civil Parish Boundary
Admin. County or County Bor. Boundary
London Borough Boundary
Symbol marking point where boundary mereing changes
BH **Beer House** **P** **Pillar, Pole or Post**
BP, BS **Boundary Post or Stone** **PO** **Post Office**
Cn, C **Capstan, Crane** **PC** **Public Convenience**
Chy **Chimney** **PH** **Public House**
D Fn **Drinking Fountain** **Pp** **Pump**
EI P **Electricity Pillar or Post** **SB, S Br** **Signal Box or Bridge**
FAP **Fire Alarm Pillar** **SP, SL** **Signal Post or Light**
FB **Foot Bridge** **Spr** **Spring**
GP **Guide Post** **Tk** **Tank or Track**
H **Hydrant or Hydraulic** **TCB** **Telephone Call Box**
LC **Level Crossing** **TCP** **Telephone Call Post**
MH **Manhole** **Tr** **Trough**
MP **Mile Post or Mooring Post** **Wr Pt, Wr T** **Water Point, Water Tap**
MS **Mile Stone** **W** **Well**
NTL **Normal Tidal Limit** **Wd Pp** **Wind Pump**

Large-Scale National Grid Data 1:2,500 and 1:1,250

Cliff **Slopes** **Top**
Rock **Rock (scattered)**
Boulders **Boulders (scattered)**
Positioned Boulder **Scree**
Non-Coniferous Tree (surveyed) **Coniferous Tree (surveyed)**
Non-Coniferous Trees (not surveyed) **Coniferous Trees (not surveyed)**
Orchard Tree **Scrub** **Bracken**
Coppice, Osier **Reeds** **Marsh, Saltings**
Rough Grassland **Heath** **Culvert**
Direction of water flow **Triangulation Station** **Antiquity (site of)**
Electricity Transmission Line **Electricity Pylon**
B.M. 231.60m **Bench Mark** **Buildings with Building Seed**
Roofed Building **Glazed Roof Building**
Civil parish/community boundary
District boundary
County boundary
Boundary post/stone
Boundary mereing symbol (note: these always appear in opposed pairs or groups of three)
Bks **Barracks** **P** **Pillar, Pole or Post**
Bty **Battery** **PO** **Post Office**
Cemy **Cemetery** **PC** **Public Convenience**
Chy **Chimney** **Pp** **Pump**
Cis **Cistern** **Ppg Sta** **Pumping Station**
Dismtd Rly **Dismantled Railway** **PW** **Place of Worship**
EI Gen Sta **Electricity Generating Station** **Sewage Ppg Sta** **Sewage Pumping Station**
EI P **Electricity Pole, Pillar** **SB, S Br** **Signal Box or Bridge**
EI Sub Sta **Electricity Sub Station** **SP, SL** **Signal Post or Light**
FB **Filter Bed** **Spr** **Spring**
Fn / D Fn **Fountain / Drinking Ftn.** **Tk** **Tank or Track**
Gas Gov **Gas Valve Compound** **Tr** **Trough**
GVC **Gas Governor** **Wd Pp** **Wind Pump**
GP **Guide Post** **Wr Pt, Wr T** **Water Point, Water Tap**
MH **Manhole** **Wks** **Works (building or area)**
MP, MS **Mile Post or Mile Stone** **W** **Well**



Historical Mapping & Photography included:

Mapping Type	Scale	Date	Pg
Lincolnshire	1:2,500	1886	2
Lincolnshire	1:2,500	1906	3
Ordnance Survey Plan	1:2,500	1975	4
Large-Scale National Grid Data	1:2,500	1994	5

Historical Map - Segment G14

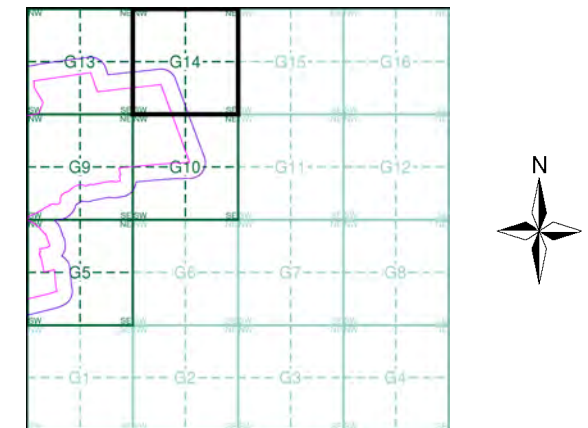

Order Details

Order Number: 297990210_1_1
 Customer Ref: 21-1088.04
 National Grid Reference: 488590, 383620
 Slice: G
 Site Area (Ha): 1120.8
 Search Buffer (m): 100

Site Details

Cottam



Tel:
Fax:
Web:

Lincolnshire
Published 1886

Source map scale - 1:2,500

The historical maps shown were reproduced from maps predominantly held at the scale adopted for England, Wales and Scotland in the 1840's. In 1854 the 1:2,500 scale was adopted for mapping urban areas and by 1896 it covered the whole of what were considered to be the cultivated parts of Great Britain. The published date given below is often some years later than the surveyed date. Before 1938, all OS maps were based on the Cassini Projection, with independent surveys of a single county or group of counties, giving rise to significant inaccuracies in outlying areas.

Map Name(s) and Date(s)

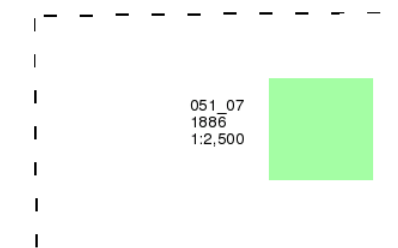

Historical Map - Segment G14

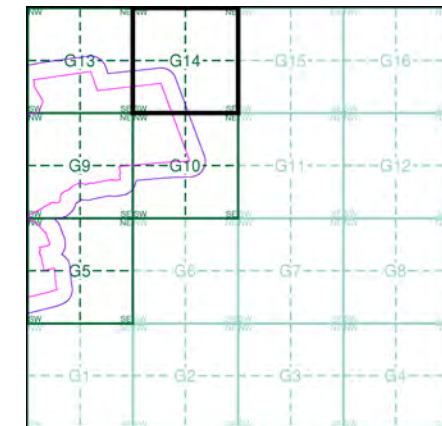

Order Details

Order Number: 297990210_1_1
 Customer Ref: 21-1088.04
 National Grid Reference: 488590, 383620
 Slice: G
 Site Area (Ha): 1120.8
 Search Buffer (m): 100

Site Details

Cottam

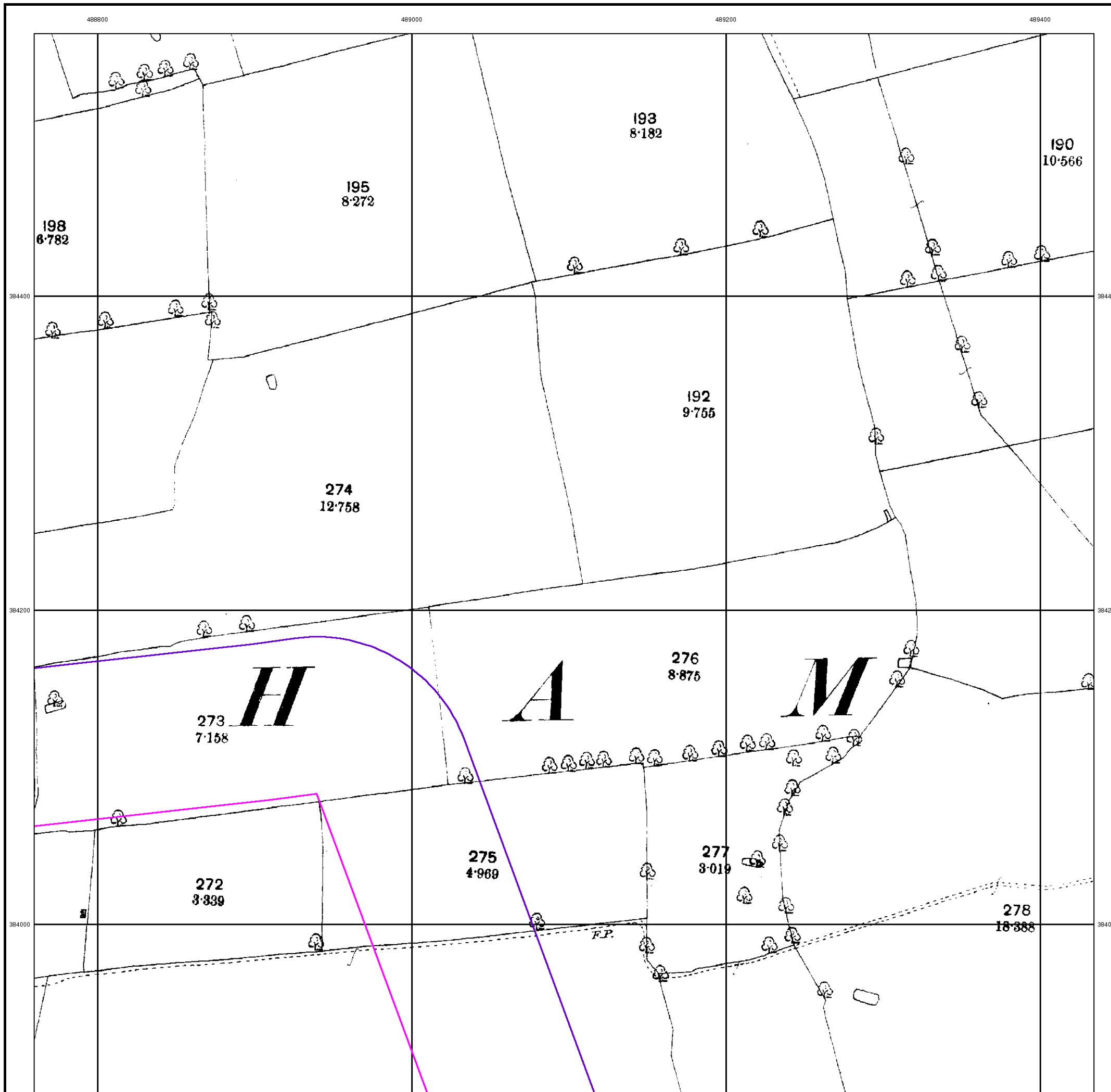

Lincolnshire
Published 1906

Source map scale - 1:2,500

The historical maps shown were reproduced from maps predominantly held at the scale adopted for England, Wales and Scotland in the 1840's. In 1854 the 1:2,500 scale was adopted for mapping urban areas and by 1896 it covered the whole of what were considered to be the cultivated parts of Great Britain. The published date given below is often some years later than the surveyed date. Before 1938, all OS maps were based on the Cassini Projection, with independent surveys of a single county or group of counties, giving rise to significant inaccuracies in outlying areas.

Map Name(s) and Date(s)

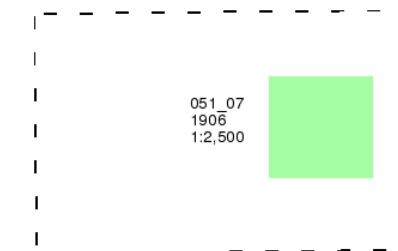

Historical Map - Segment G14

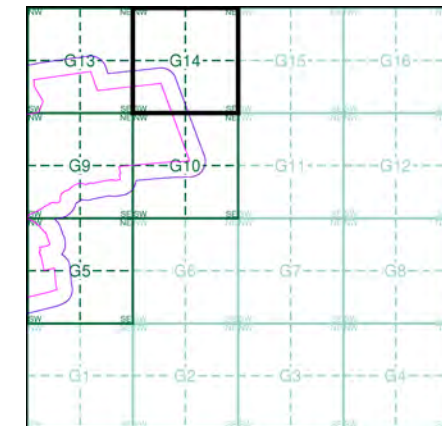

Order Details

Order Number: 297990210_1_1
 Customer Ref: 21-1088.04
 National Grid Reference: 488590, 383620
 Slice: G
 Site Area (Ha): 1120.8
 Search Buffer (m): 100

Site Details

Cottam

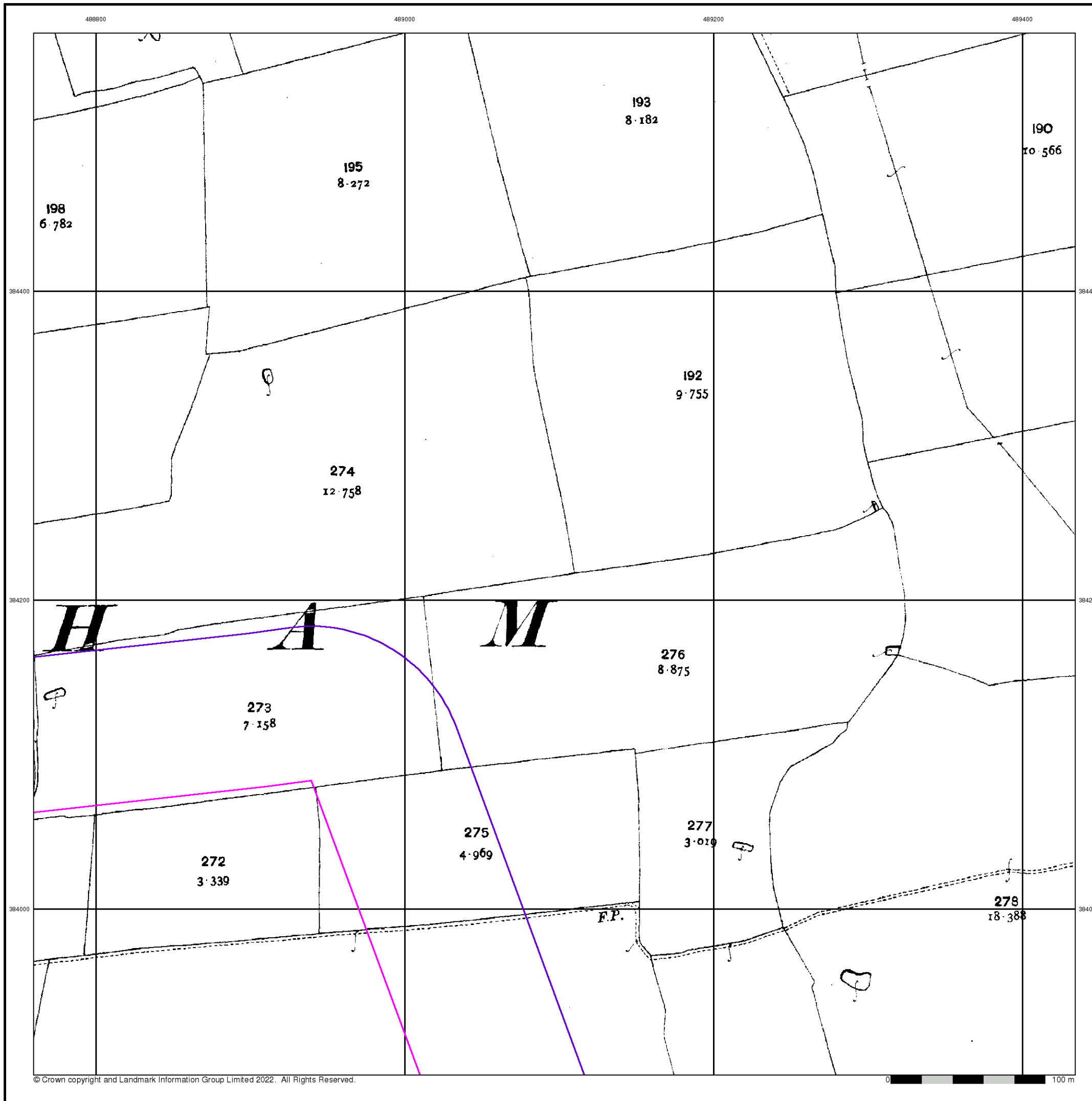

Ordnance Survey Plan

Published 1975

Source map scale - 1:2,500

The historical maps shown were reproduced from maps predominantly held at the scale adopted for England, Wales and Scotland in the 1840's. In 1854 the 1:2,500 scale was adopted for mapping urban areas and by 1896 it covered the whole of what were considered to be the cultivated parts of Great Britain. The published date given below is often some years later than the surveyed date. Before 1938, all OS maps were based on the Cassini Projection, with independent surveys of a single county or group of counties, giving rise to significant inaccuracies in outlying areas.

Map Name(s) and Date(s)

SK8884 1975 1:2,500	SK8984 1975 1:2,500
SK8883 1975 1:2,500	SK8983 1975 1:2,500

Historical Map - Segment G14

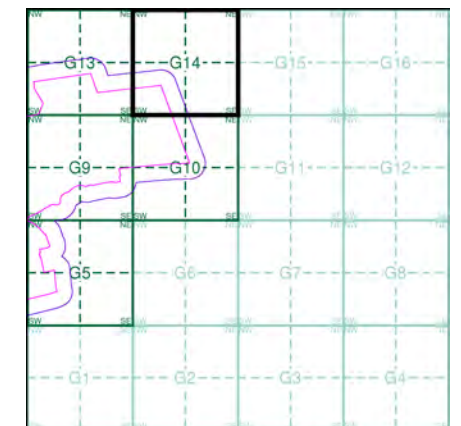

Order Details

Order Number: 297990210_1_1
 Customer Ref: 21-1088.04
 National Grid Reference: 488590, 383620
 Slice: G
 Site Area (Ha): 1120.8
 Search Buffer (m): 100

Site Details

Cottam

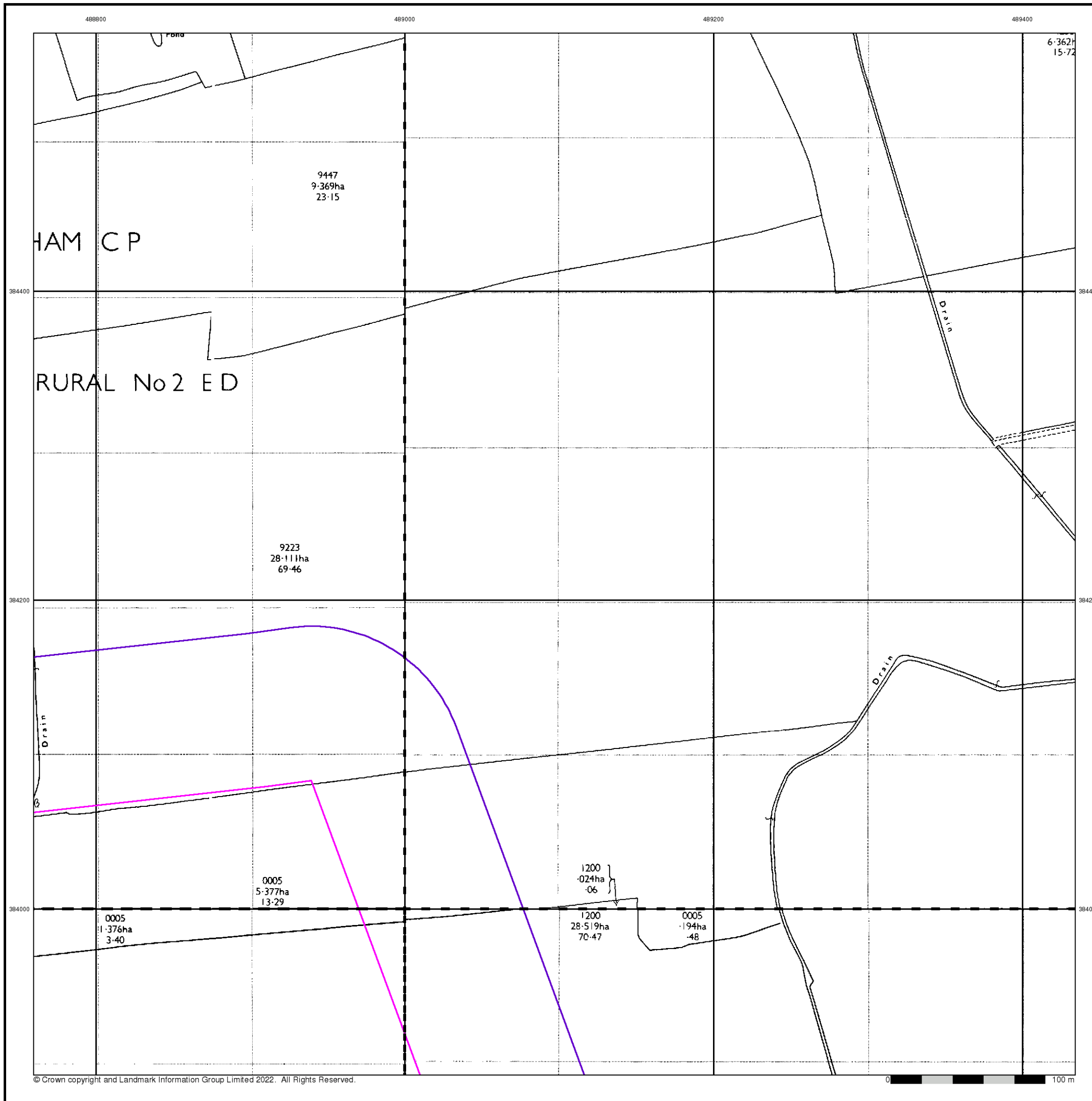

Large-Scale National Grid Data

Published 1994

Source map scale - 1:2,500

'Large Scale National Grid Data' superseded SIM cards (Ordnance Survey's 'Survey of Information on Microfilm') in 1992, and continued to be produced until 1999. These maps were the fore-runners of digital mapping and so provide detailed information on houses and roads, but tend to show less topographic features such as vegetation. These maps were produced at both 1:2,500 and 1:1,250 scales.

Map Name(s) and Date(s)

SK8884	SK8984
1994	1994
1:2,500	1:2,500
SK8883	SK8983
1994	1994
1:2,500	1:2,500

Historical Map - Segment G14

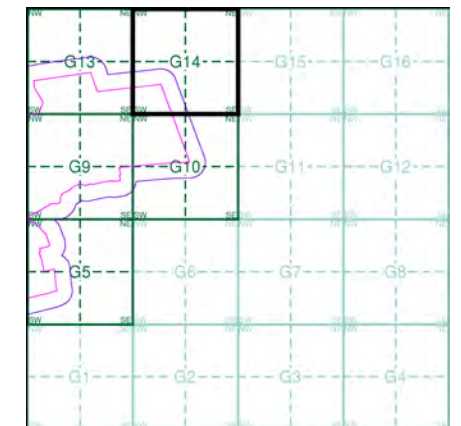

Order Details

Order Number: 297990210_1_1
 Customer Ref: 21-1088.04
 National Grid Reference: 488590, 383620
 Slice: G
 Site Area (Ha): 1120.8
 Search Buffer (m): 100

Site Details

Cottam

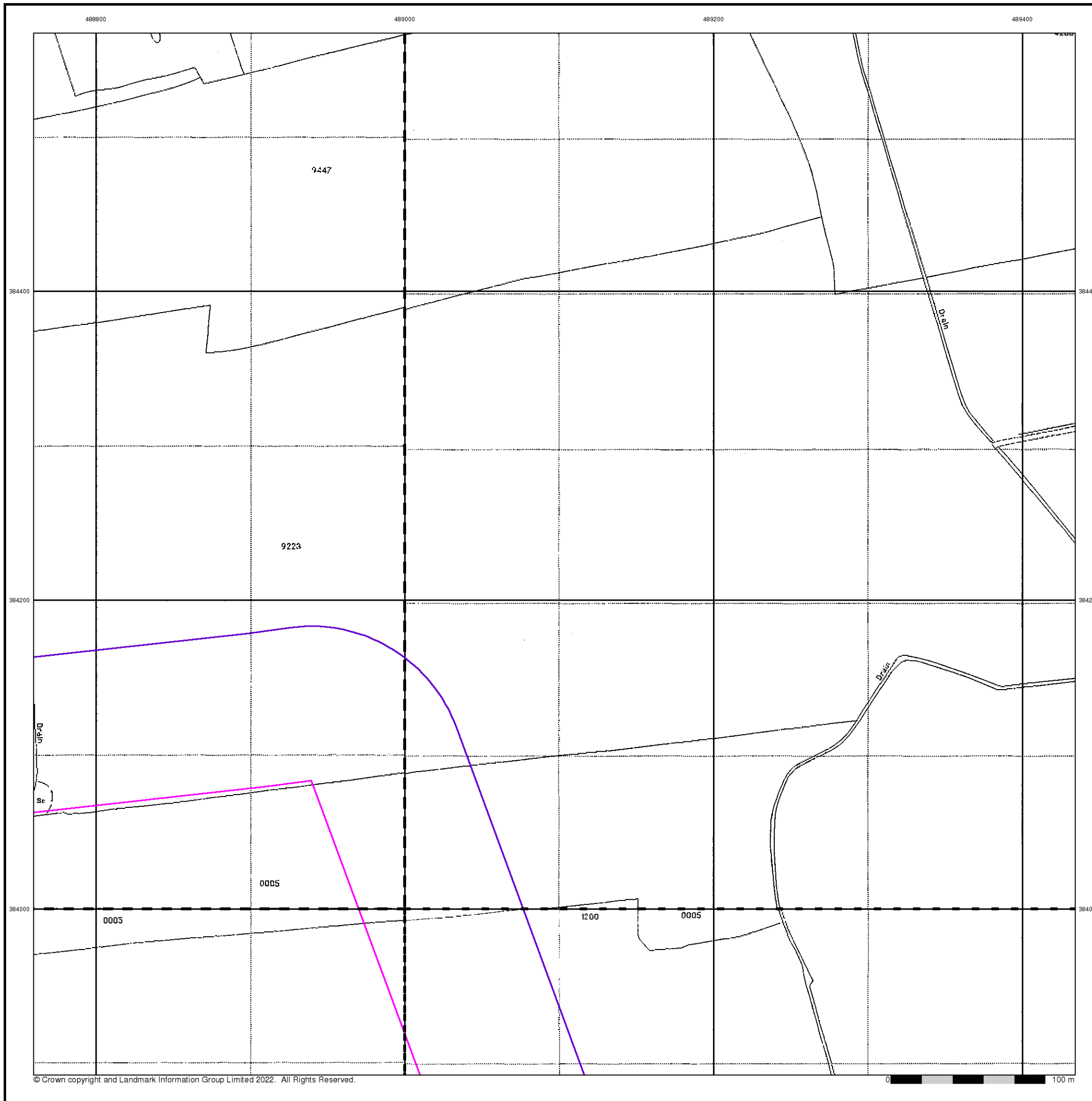

Historical Mapping Legends

Ordnance Survey County Series 1:10,560

- Gravel Pit
- Sand Pit
- Other Pits
- Quarry
- Shingle
- Orchard
- Osiers
- Reeds
- Marsh
- Mixed Wood
- Deciduous
- Brushwood
- Fir
- Furze
- Rough Pasture
- Arrow denotes flow of water
- Trigonometrical Station
- Site of Antiquities
- Bench Mark
- Pump, Guide Post, Signal Post
- Well, Spring, Boundary Post
- 285** Surface Level
- Sketched Contour
- Instrumental Contour
- Main Roads
- Minor Roads
- Sunken Road
- Raised Road
- Road over Railway
- Railway over River
- Railway over Road
- Level Crossing
- Road over River or Canal
- Road over Stream
- Road over Stream
- County Boundary (Geographical)
- County & Civil Parish Boundary
- Administrative County & Civil Parish Boundary
- County Borough Boundary (England)
- County Burgh Boundary (Scotland)
- Rural District Boundary
- Civil Parish Boundary

Ordnance Survey Plan 1:10,000

- Chalk Pit, Clay Pit or Quarry
- Gravel Pit
- Sand Pit
- Disused Pit or Quarry
- Refuse or Slag Heap
- Lake, Loch or Pond
- Dunes
- Boulders
- Coniferous Trees
- Non-Coniferous Trees
- Orchard
- Scrub
- Coppice
- Bracken
- Heath
- Rough Grassland
- Marsh
- Reeds
- Saltings
- Building
- Glasshouse
- Sloping Masonry
- Pylon
- Electricity Transmission Line
- Pole
- Cutting
- Embankment
- Standard Gauge Multiple Track
- Standard Gauge Single Track
- Siding, Tramway or Mineral Line
- Narrow Gauge
- Geographical County
- Administrative County, County Borough or County of City
- Municipal Borough, Urban or Rural District, Burgh or District Council
- Borough, Burgh or County Constituency
Shown only when not coincident with other boundaries
- Civil Parish
Shown alternately when coincidence of boundaries occurs
- BP, BS Boundary Post or Stone
- Ch Church
- CH Club House
- F E Sta Fire Engine Station
- FB Foot Bridge
- Fn Fountain
- GP Guide Post
- MP Mile Post
- MS Mile Stone
- Pol Sta Police Station
- PO Post Office
- PC Public Convenience
- PH Public House
- SB Signal Box
- Spr Spring
- TCB Telephone Call Box
- TCP Telephone Call Post
- W Well

1:10,000 Raster Mapping

- Gravel Pit
- Rock
- Boulders
- Shingle
- Sand
- Slopes
- General detail
- Overhead detail
- Multi-track railway
- County boundary (England only)
- District, Unitary, Metropolitan, London Borough boundary
- Area of wooded vegetation
- Non-coniferous trees (scattered)
- Coniferous trees (scattered)
- Orchard
- Rough Grassland
- Scrub
- Water feature
- MHW(S) Mean high water (springs)
- Bench mark (where shown)
- Point feature (e.g. Guide Post or Mile Stone)
- Site of (antiquity)
- General Building
- Refuse tip or slag heap
- Rock (scattered)
- Boulders (scattered)
- Mud
- Sand Pit
- Top of cliff
- Underground detail
- Narrow gauge railway
- Single track railway
- Civil, parish or community boundary
- Constituency boundary
- Non-coniferous trees
- Coniferous trees
- Positioned tree
- Coppice or Osiers
- Heath
- Marsh, Salt Marsh or Reeds
- Flow arrows
- MLW(S) Mean low water (springs)
- Triangulation station
- Pylon, flare stack or lighting tower
- Glasshouse
- Important Building



Historical Mapping & Photography included:

Mapping Type	Scale	Date	Pg
Lincolnshire	1:10,560	1885	2
Lincolnshire	1:10,560	1907	3
Lincolnshire	1:10,560	1907	4
Lincolnshire	1:10,560	1947	5
Ordnance Survey Plan	1:10,000	1956	6
Ordnance Survey Plan	1:10,000	1979	7
Ordnance Survey Plan	1:10,000	1981	8
10K Raster Mapping	1:10,000	2000	9
Street View	Variable		10

Historical Map - Slice A

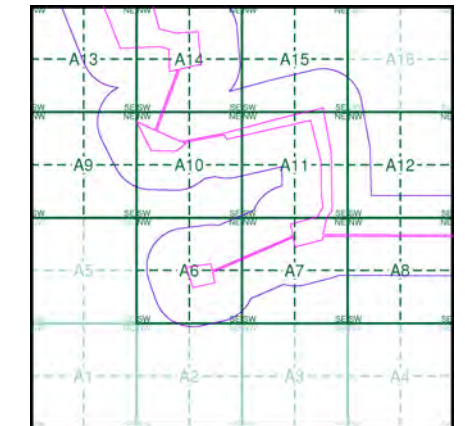

Order Details

Order Number: 297990273_1_1
 Customer Ref: 21-1088.04
 National Grid Reference: 489950, 382840
 Slice: A
 Site Area (Ha): 469.98
 Search Buffer (m): 250

Site Details

Cottam



Tel: [Redacted]
 Fax: [Redacted]
 Web: [Redacted]

Lincolnshire

Published 1885

Source map scale - 1:10,560

The historical maps shown were reproduced from maps predominantly held at the scale adopted for England, Wales and Scotland in the 1840's. In 1854 the 1:2,500 scale was adopted for mapping urban areas; these maps were used to update the 1:10,560 maps. The published date given therefore is often some years later than the surveyed date. Before 1938, all OS maps were based on the Cassini Projection, with independent surveys of a single county or group of counties, giving rise to significant inaccuracies in outlying areas. In the late 1940's, a Provisional Edition was produced, which updated the 1:10,560 mapping from a number of sources. The maps appear unfinished - with all military camps and other strategic sites removed. These maps were initially overprinted with the National Grid. In 1970, the first 1:10,000 maps were produced using the Transverse Mercator Projection. The revision process continued until recently, with new editions appearing every 10 years or so for urban areas.

Map Name(s) and Date(s)

051NE
1885
1:10,560
051SE
1885
1:10,560

Historical Map - Slice A

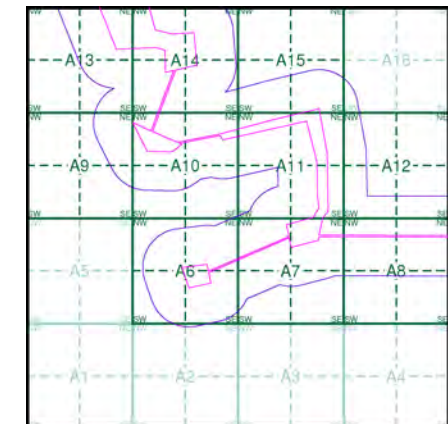

Order Details

Order Number: 297990273_1_1
 Customer Ref: 21-1088.04
 National Grid Reference: 489950, 382840
 Slice: A
 Site Area (Ha): 469.98
 Search Buffer (m): 250

Site Details

Cottam

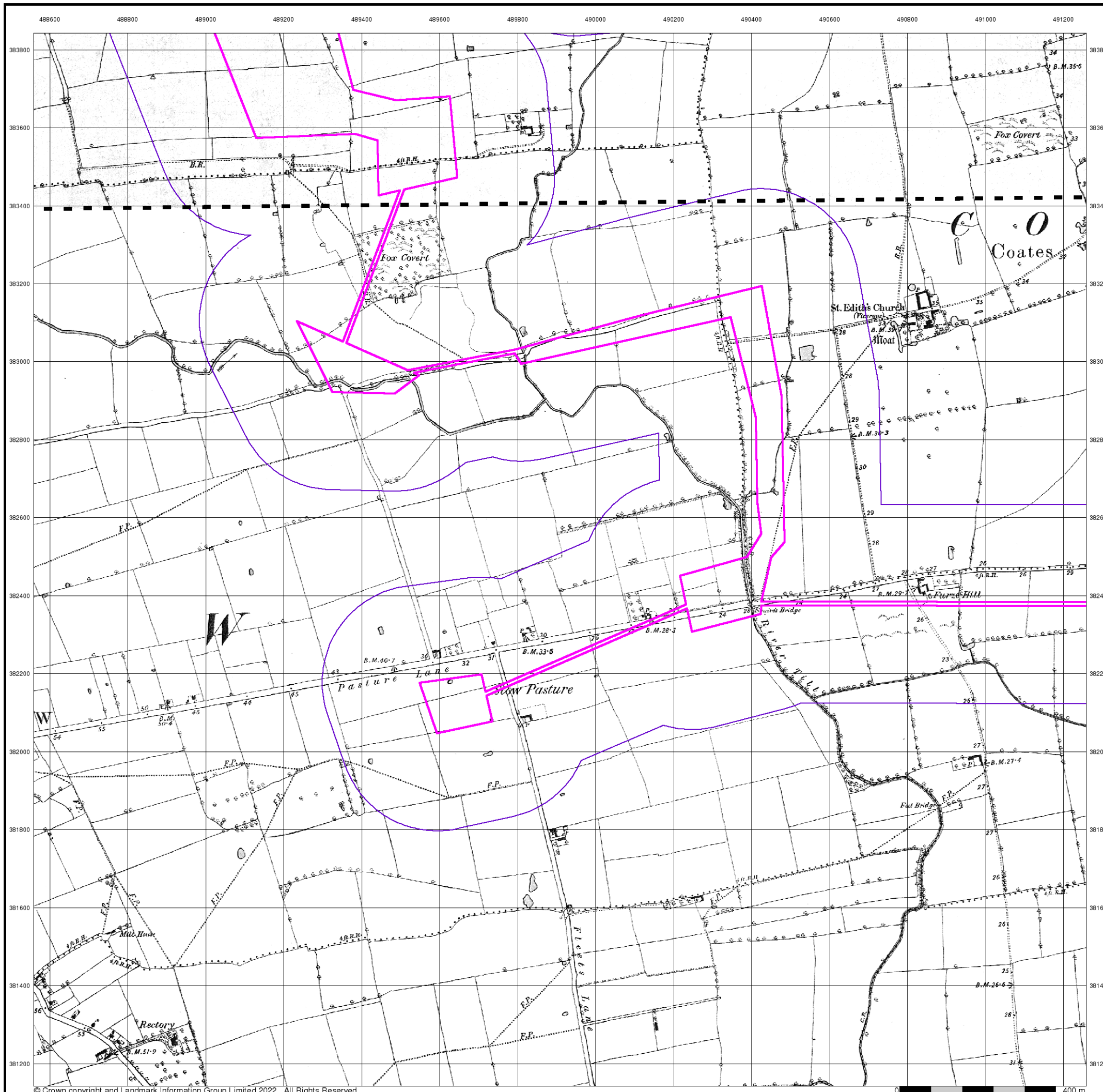

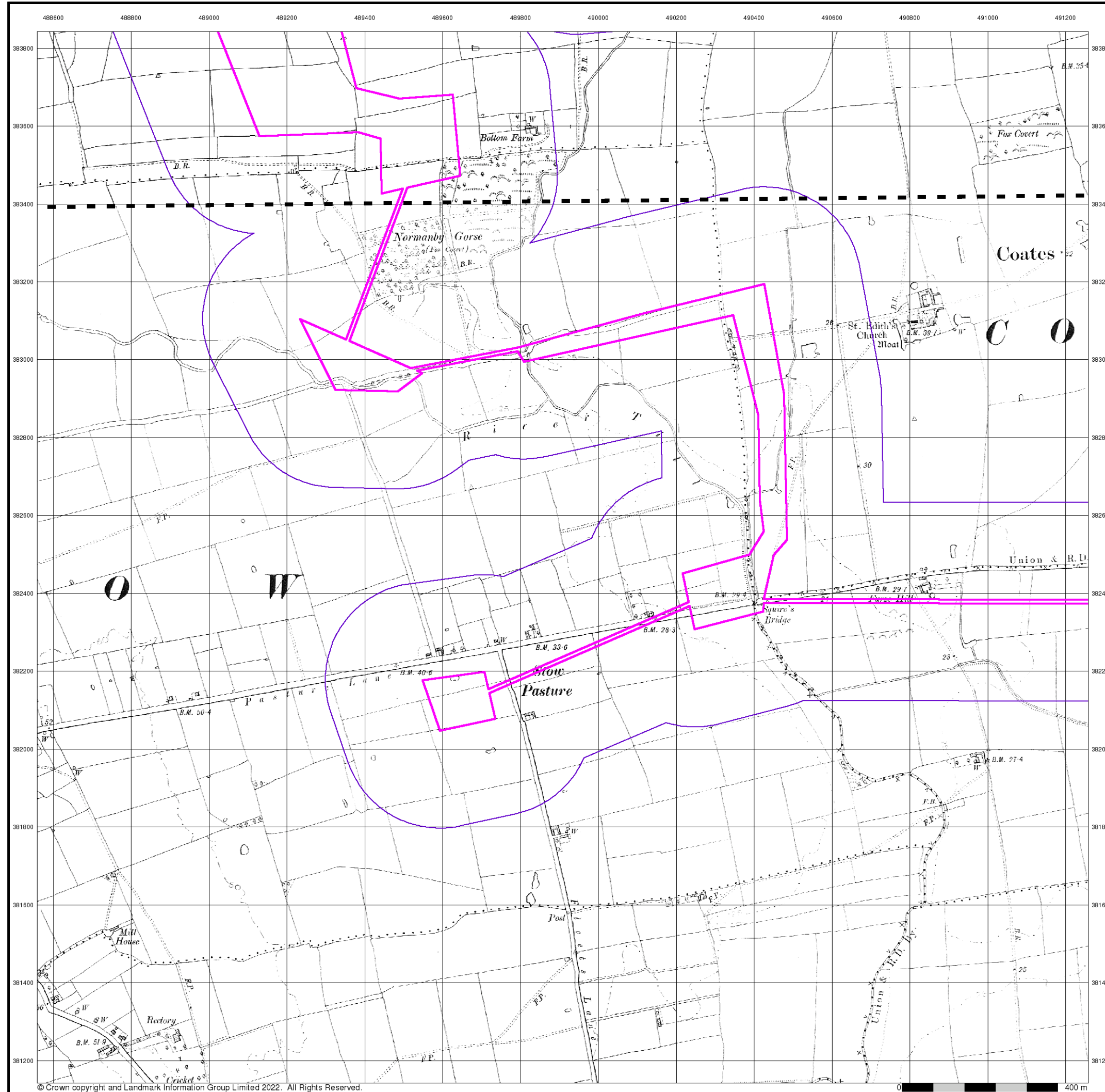

© Crown copyright and Landmark Information Group Limited 2022. All Rights Reserved.



Lincolnshire

Published 1907

Source map scale - 1:10,560

The historical maps shown were reproduced from maps predominantly held at the scale adopted for England, Wales and Scotland in the 1840's. In 1854 the 1:2,500 scale was adopted for mapping urban areas; these maps were used to update the 1:10,560 maps. The published date given therefore is often some years later than the surveyed date. Before 1938, all OS maps were based on the Cassini Projection, with independent surveys of a single county or group of counties, giving rise to significant inaccuracies in outlying areas. In the late 1940's, a Provisional Edition was produced, which updated the 1:10,560 mapping from a number of sources. The maps appear unfinished - with all military camps and other strategic sites removed. These maps were initially overprinted with the National Grid. In 1970, the first 1:10,000 maps were produced using the Transverse Mercator Projection. The revision process continued until recently, with new editions appearing every 10 years or so for urban areas.

Map Name(s) and Date(s)

051NE 1907 1:10,560
051SE 1907 1:10,560

Historical Map - Slice A

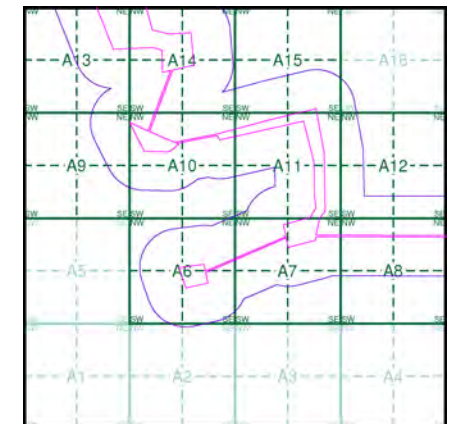

Order Details

Order Number: 297990273_1_1
 Customer Ref: 21-1088.04
 National Grid Reference: 489950, 382840
 Slice: A
 Site Area (Ha): 469.98
 Search Buffer (m): 250

Site Details

Cottam



Tel: [Redacted]
 Fax: [Redacted]
 Web: [Redacted]

Lincolnshire

Published 1907

Source map scale - 1:10,560

The historical maps shown were reproduced from maps predominantly held at the scale adopted for England, Wales and Scotland in the 1840's. In 1854 the 1:2,500 scale was adopted for mapping urban areas; these maps were used to update the 1:10,560 maps. The published date given therefore is often some years later than the surveyed date. Before 1938, all OS maps were based on the Cassini Projection, with independent surveys of a single county or group of counties, giving rise to significant inaccuracies in outlying areas. In the late 1940's, a Provisional Edition was produced, which updated the 1:10,560 mapping from a number of sources. The maps appear unfinished - with all military camps and other strategic sites removed. These maps were initially overprinted with the National Grid. In 1970, the first 1:10,000 maps were produced using the Transverse Mercator Projection. The revision process continued until recently, with new editions appearing every 10 years or so for urban areas.

Map Name(s) and Date(s)

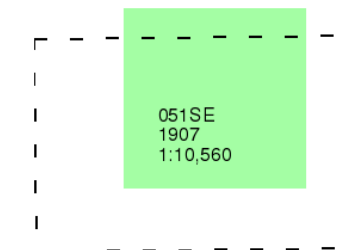

Historical Map - Slice A

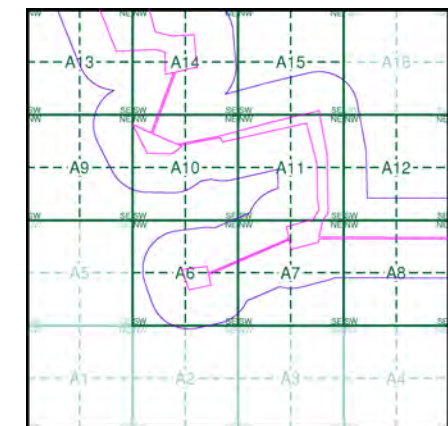

Order Details

Order Number: 297990273_1_1
 Customer Ref: 21-1088.04
 National Grid Reference: 489950, 382840
 Slice: A
 Site Area (Ha): 469.98
 Search Buffer (m): 250

Site Details

Cottam

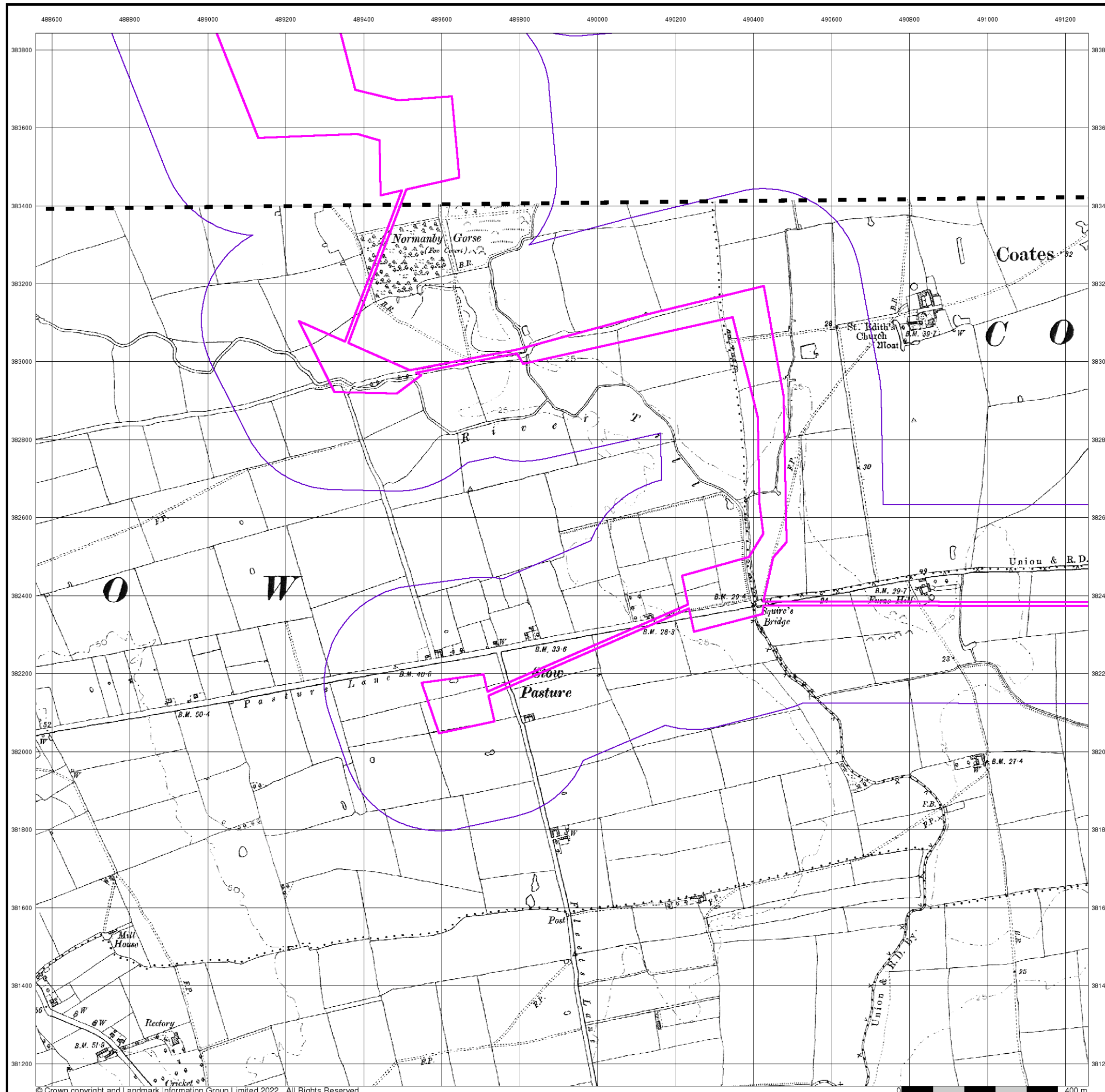

Lincolnshire
Published 1947

Source map scale - 1:10,560

The historical maps shown were reproduced from maps predominantly held at the scale adopted for England, Wales and Scotland in the 1840's. In 1854 the 1:2,500 scale was adopted for mapping urban areas; these maps were used to update the 1:10,560 maps. The published date given therefore is often some years later than the surveyed date. Before 1938, all OS maps were based on the Cassini Projection, with independent surveys of a single county or group of counties, giving rise to significant inaccuracies in outlying areas. In the late 1940's, a Provisional Edition was produced, which updated the 1:10,560 mapping from a number of sources. The maps appear unfinished - with all military camps and other strategic sites removed. These maps were initially overprinted with the National Grid. In 1970, the first 1:10,000 maps were produced using the Transverse Mercator Projection. The revision process continued until recently, with new editions appearing every 10 years or so for urban areas.

Map Name(s) and Date(s)

051NE
1947
1:10,560
051SE
1947
1:10,560

Historical Map - Slice A

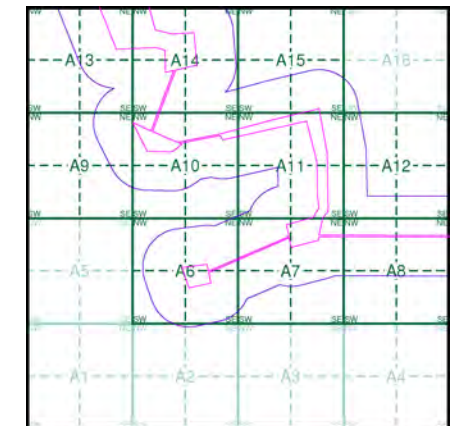

Order Details

Order Number: 297990273_1_1
 Customer Ref: 21-1088.04
 National Grid Reference: 489950, 382840
 Slice: A
 Site Area (Ha): 469.98
 Search Buffer (m): 250

Site Details

Cottam

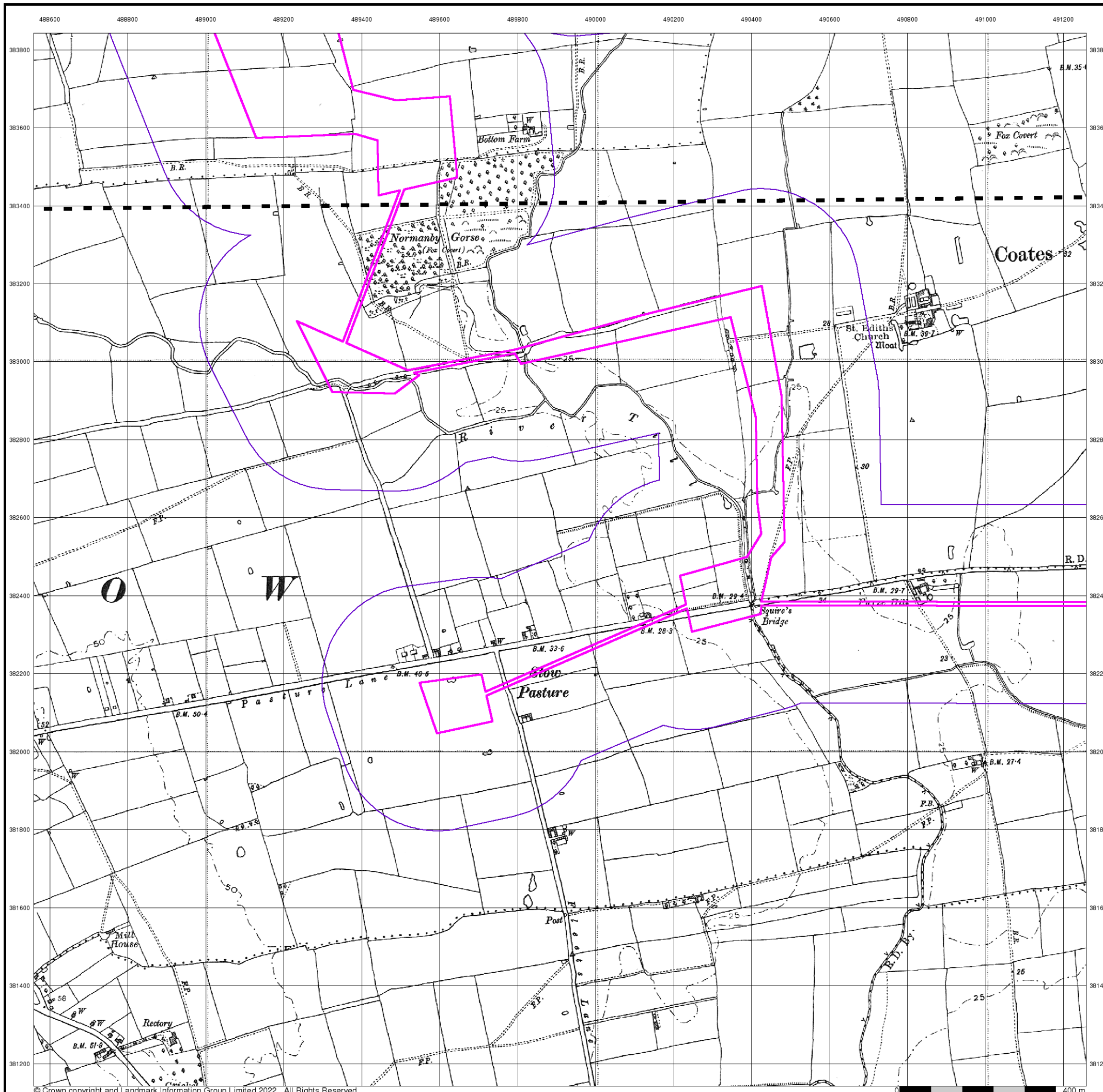

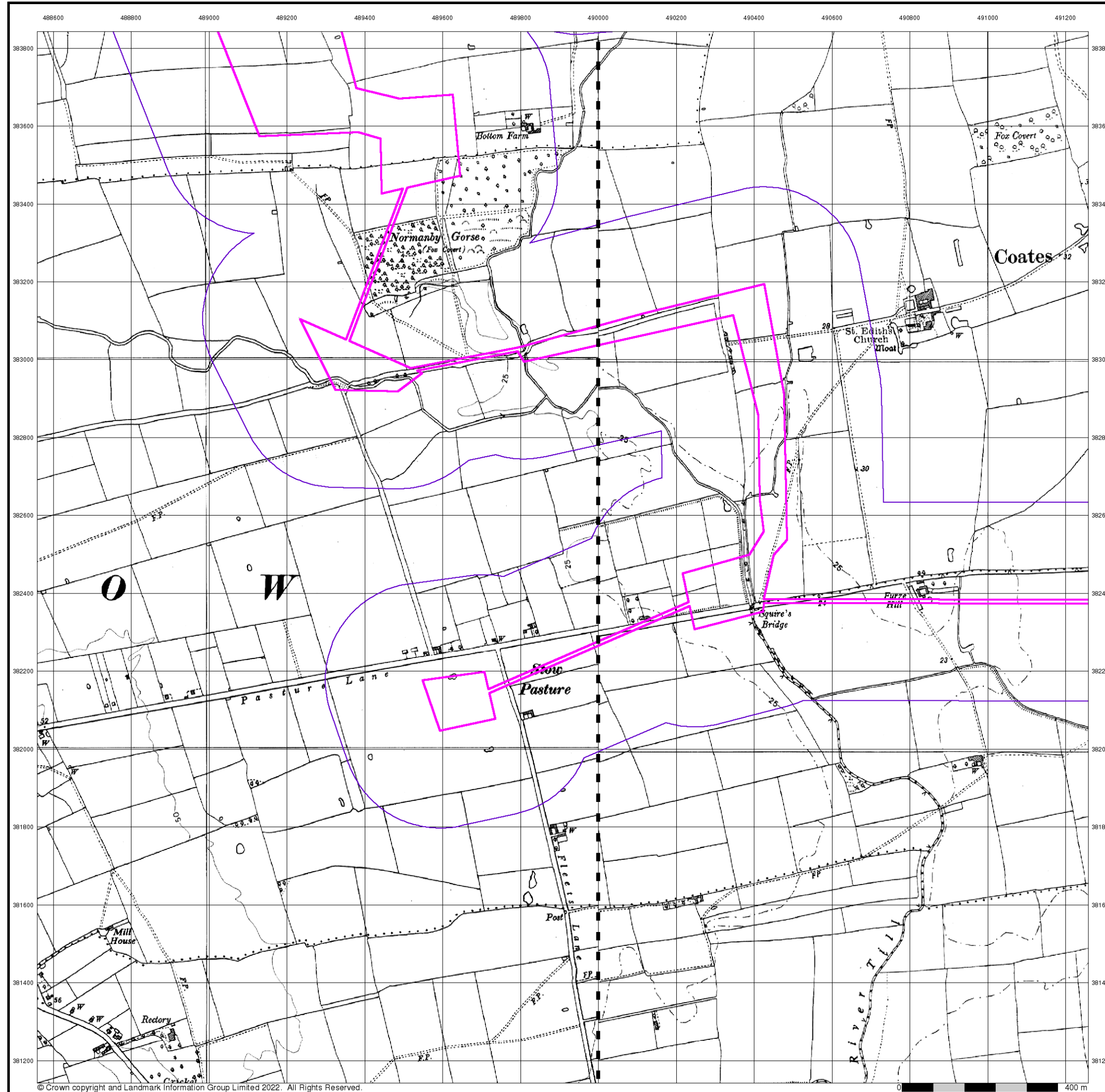

© Crown copyright and Landmark Information Group Limited 2022. All Rights Reserved.



Ordnance Survey Plan

Published 1956

Source map scale - 1:10,000

The historical maps shown were reproduced from maps predominantly held at the scale adopted for England, Wales and Scotland in the 1840's. In 1854 the 1:2,500 scale was adopted for mapping urban areas; these maps were used to update the 1:10,560 maps. The published date given therefore is often some years later than the surveyed date. Before 1938, all OS maps were based on the Cassini Projection, with independent surveys of a single county or group of counties, giving rise to significant inaccuracies in outlying areas. In the late 1940's, a Provisional Edition was produced, which updated the 1:10,560 mapping from a number of sources. The maps appear unfinished - with all military camps and other strategic sites removed. These maps were initially overprinted with the National Grid. In 1970, the first 1:10,000 maps were produced using the Transverse Mercator Projection. The revision process continued until recently, with new editions appearing every 10 years or so for urban areas.

Map Name(s) and Date(s)

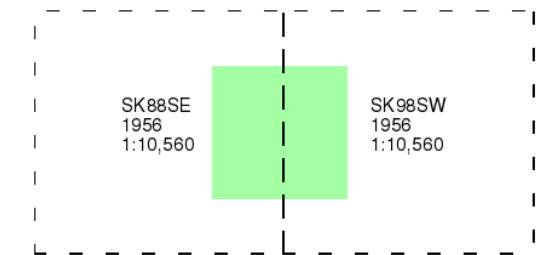

Historical Map - Slice A

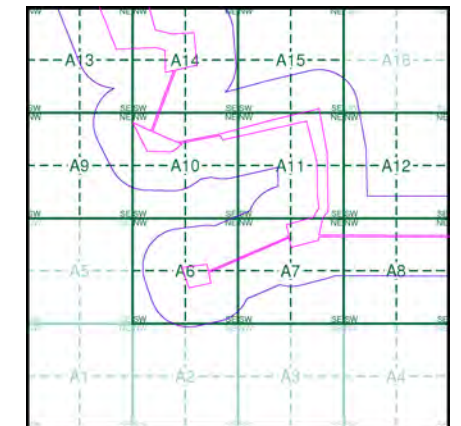

Order Details

Order Number: 297990273_1_1
 Customer Ref: 21-1088.04
 National Grid Reference: 489950, 382840
 Slice: A
 Site Area (Ha): 469.98
 Search Buffer (m): 250

Site Details

Cottam



Tel: [Redacted]
 Fax: [Redacted]
 Web: [Redacted]

Ordnance Survey Plan

Published 1979

Source map scale - 1:10,000

The historical maps shown were reproduced from maps predominantly held at the scale adopted for England, Wales and Scotland in the 1840's. In 1854 the 1:2,500 scale was adopted for mapping urban areas; these maps were used to update the 1:10,560 maps. The published date given therefore is often some years later than the surveyed date. Before 1938, all OS maps were based on the Cassini Projection, with independent surveys of a single county or group of counties, giving rise to significant inaccuracies in outlying areas. In the late 1940's, a Provisional Edition was produced, which updated the 1:10,560 mapping from a number of sources. The maps appear unfinished - with all military camps and other strategic sites removed. These maps were initially overprinted with the National Grid. In 1970, the first 1:10,000 maps were produced using the Transverse Mercator Projection. The revision process continued until recently, with new editions appearing every 10 years or so for urban areas.

Map Name(s) and Date(s)

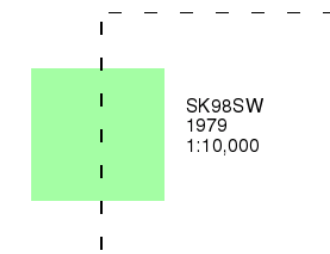

Historical Map - Slice A

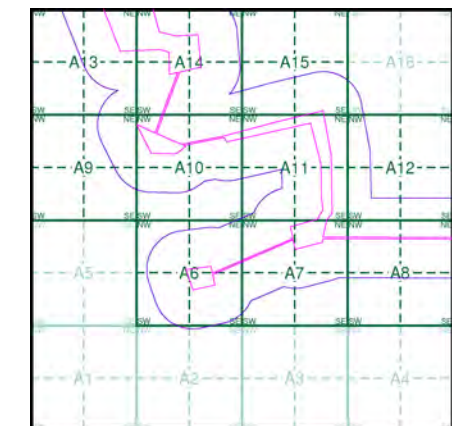

Order Details

Order Number: 297990273_1_1
 Customer Ref: 21-1088.04
 National Grid Reference: 489950, 382840
 Slice: A
 Site Area (Ha): 469.98
 Search Buffer (m): 250

Site Details

Cottam

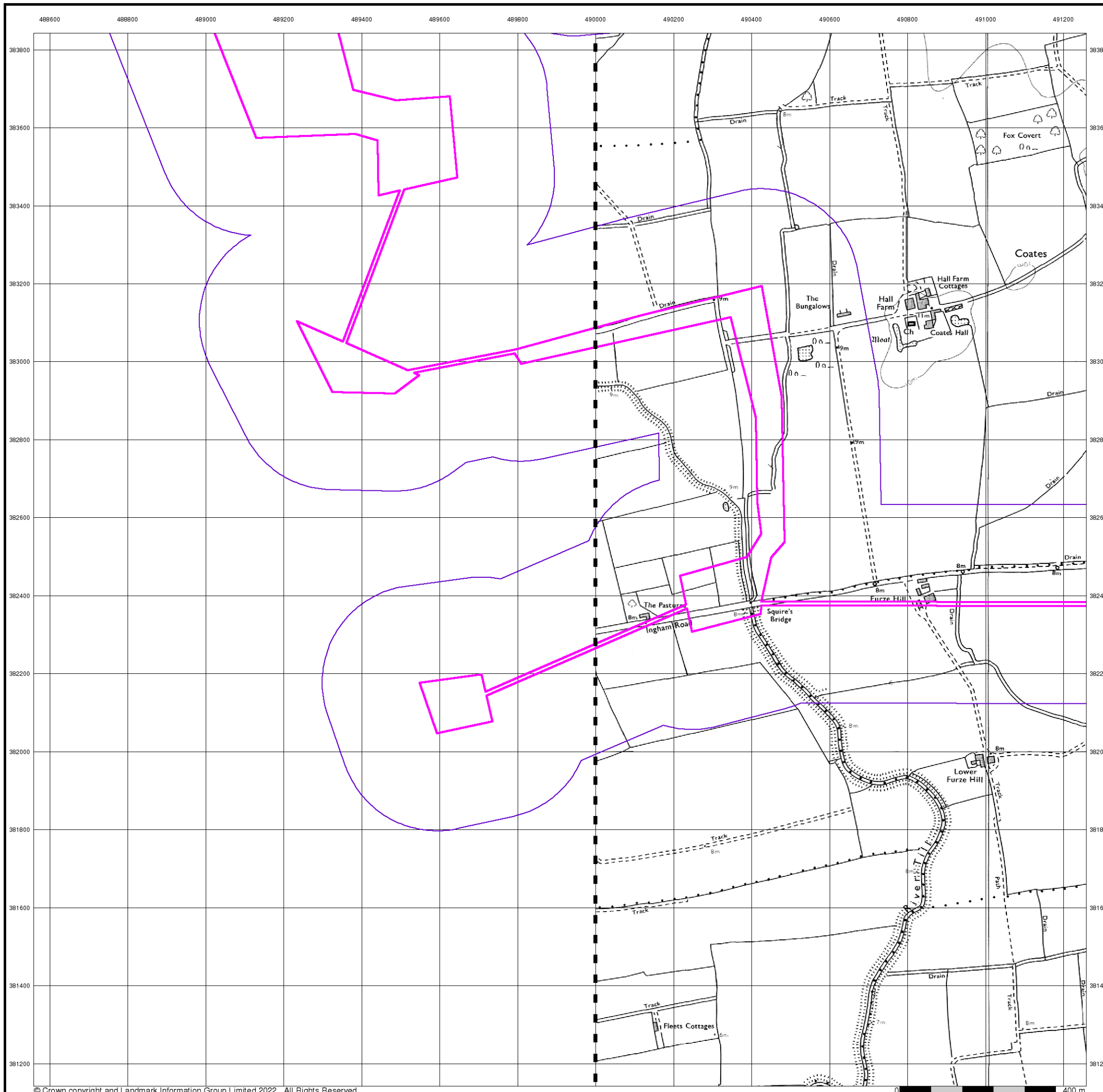

Ordnance Survey Plan

Published 1981

Source map scale - 1:10,000

The historical maps shown were reproduced from maps predominantly held at the scale adopted for England, Wales and Scotland in the 1840's. In 1854 the 1:2,500 scale was adopted for mapping urban areas; these maps were used to update the 1:10,560 maps. The published date given therefore is often some years later than the surveyed date. Before 1938, all OS maps were based on the Cassini Projection, with independent surveys of a single county or group of counties, giving rise to significant inaccuracies in outlying areas. In the late 1940's, a Provisional Edition was produced, which updated the 1:10,560 mapping from a number of sources. The maps appear unfinished - with all military camps and other strategic sites removed. These maps were initially overprinted with the National Grid. In 1970, the first 1:10,000 maps were produced using the Transverse Mercator Projection. The revision process continued until recently, with new editions appearing every 10 years or so for urban areas.

Map Name(s) and Date(s)

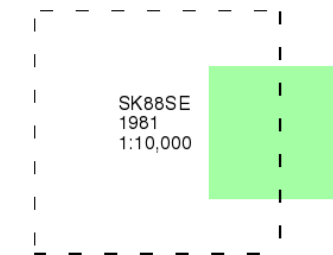

Historical Map - Slice A

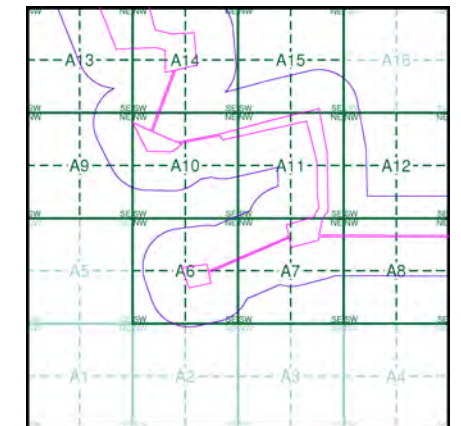

Order Details

Order Number: 297990273_1_1
 Customer Ref: 21-1088.04
 National Grid Reference: 489950, 382840
 Slice: A
 Site Area (Ha): 469.98
 Search Buffer (m): 250

Site Details

Cottam

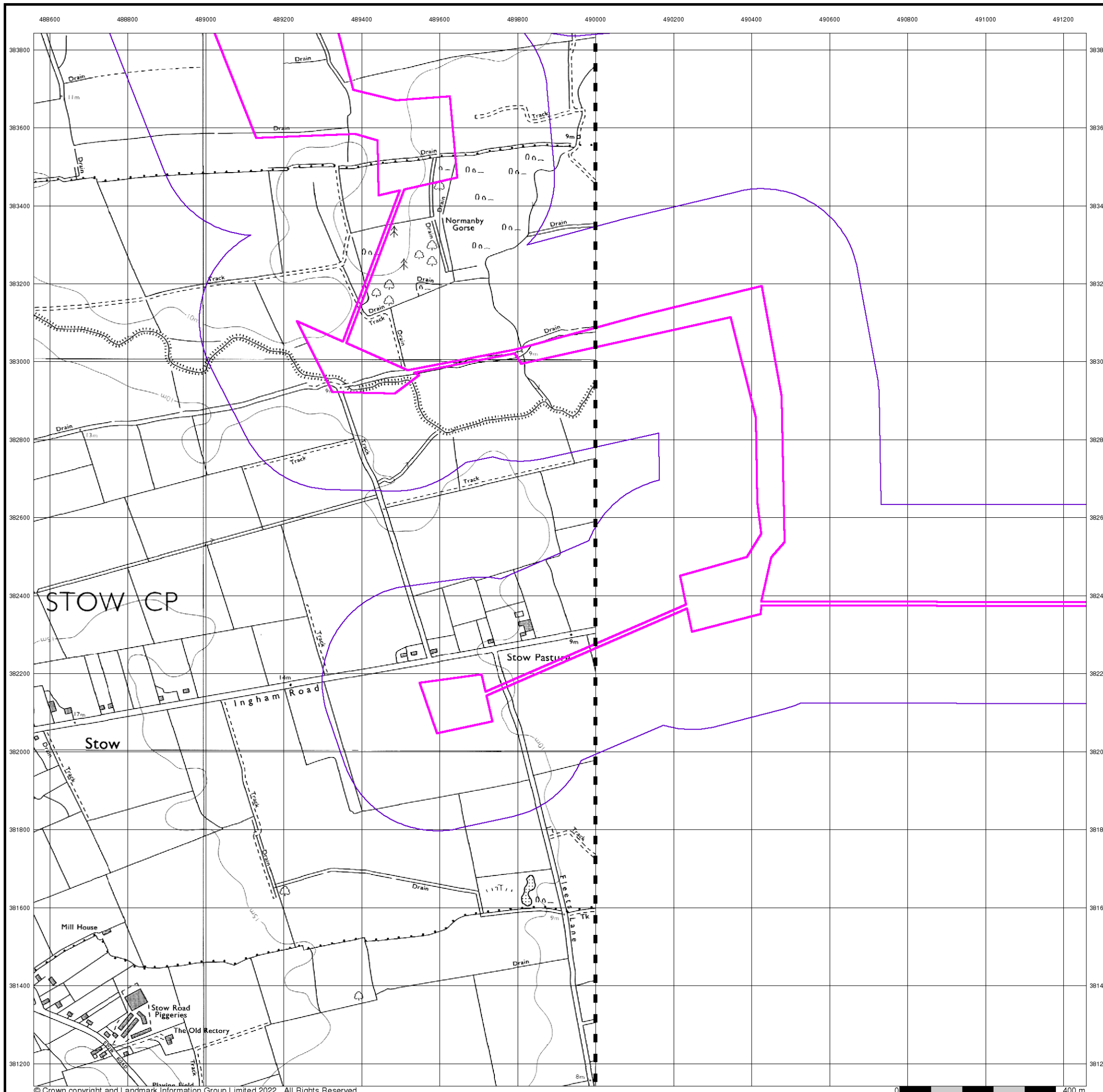

10k Raster Mapping
Published 2000
Source map scale - 1:10,000

The historical maps shown were produced from the Ordnance Survey's 1:10,000 colour raster mapping. These maps are derived from Landplan which replaced the old 1:10,000 maps originally published in 1970. The data is highly detailed showing buildings, fences and field boundaries as well as all roads, tracks and paths. Road names are also included together with the relevant road number and classification. Boundary information depiction includes county, unitary authority, district, civil parish and constituency.

Map Name(s) and Date(s)

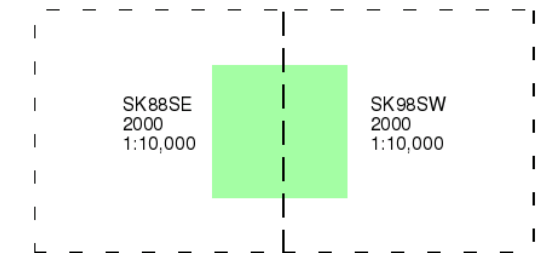

Historical Map - Slice A

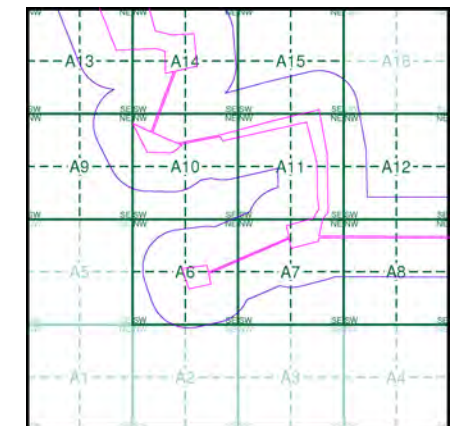

Order Details

Order Number: 297990273_1_1
 Customer Ref: 21-1088.04
 National Grid Reference: 489950, 382840
 Slice: A
 Site Area (Ha): 469.98
 Search Buffer (m): 250

Site Details

Cottam

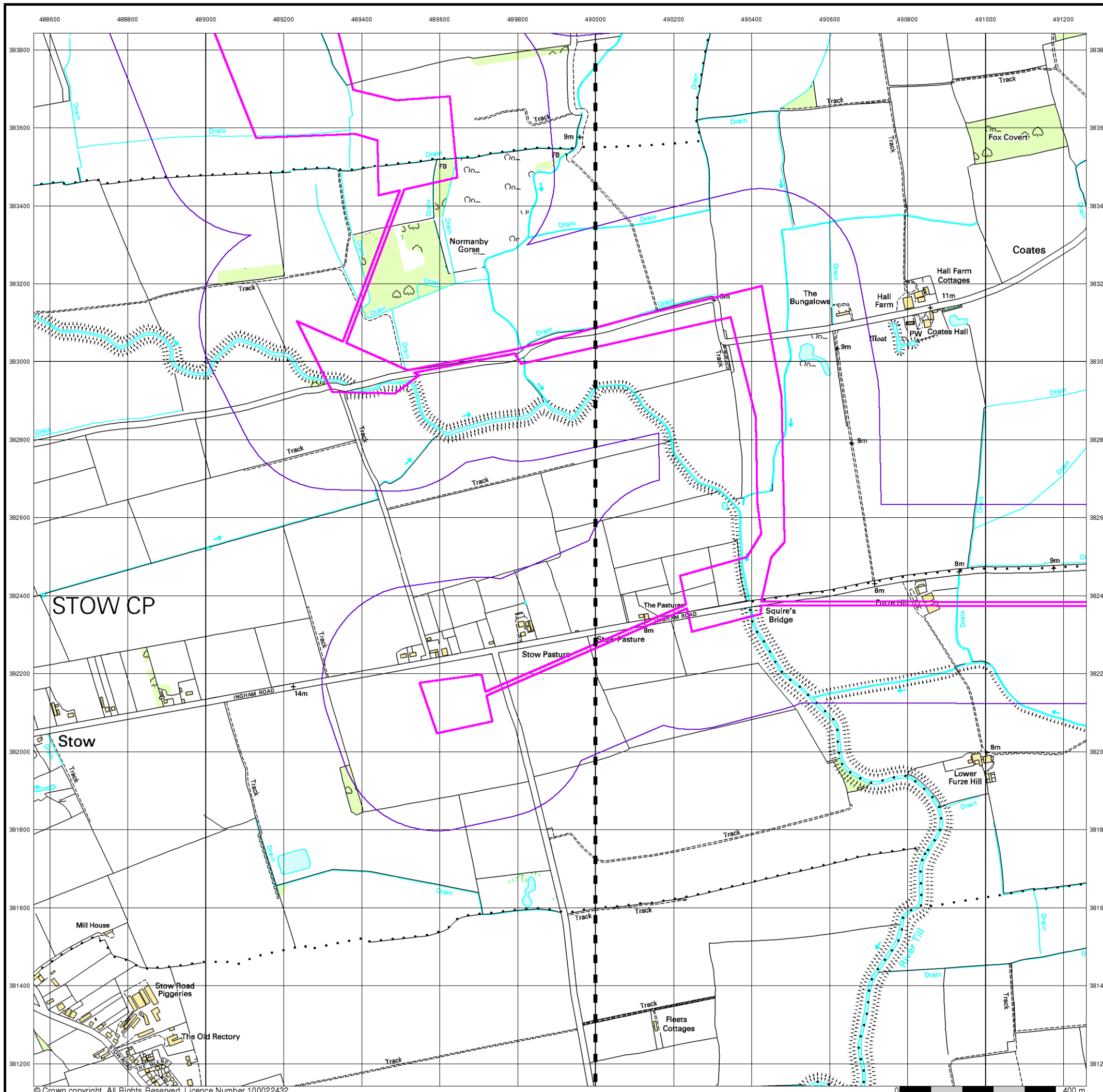

Street View

Published 2022

Source map scale - 1:10,000

Street View is a street-level map for the whole of Great Britain produced by the Ordnance Survey. These maps are provided at a nominal scale of 1:10,000

Map Name(s) and Date(s)



Street View Map - Slice A

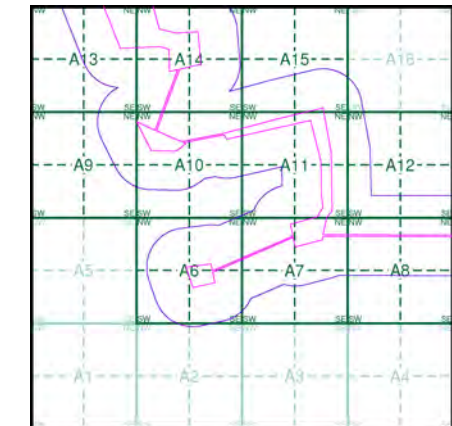

Order Details

Order Number: 297990273_1_1
 Customer Ref: 21-1088.04
 National Grid Reference: 489950, 382840
 Slice: A
 Site Area (Ha): 469.98
 Search Buffer (m): 250

Site Details

Cottam

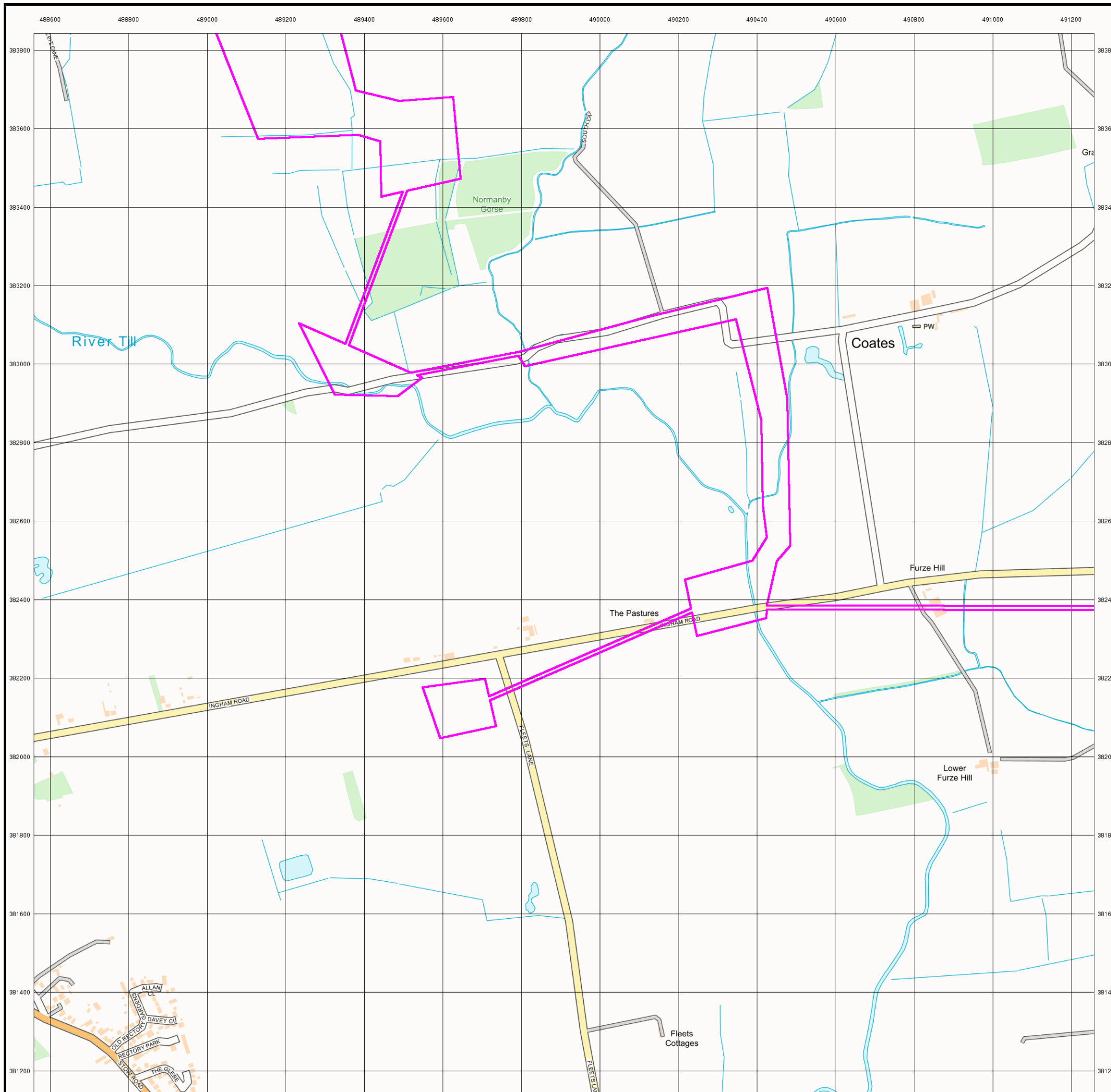

Historical Mapping Legends

Ordnance Survey County Series and Ordnance Survey Plan 1:2,500

Quarry **Gravel Pit** **Sand Pit**
Clay Pit **Shingle** **Refuse Heap**
Sloping Masonry **Flat Rock**
Marsh **Reeds** **Osiers**
Rough Pasture **Furze** **Wood**
Mixed Wood **Brushwood** **Orchard**
Fir **Ford** **Stepping Stones**
Ferry **Waterfall** **Lock**
Trig. Station **Altitude at Trig. Station**
B.M. 325.9 **Bench Mark** **Surface Level**
Arrow denotes flow of water **Antiquities (site of)**
Cutting **Embankment**
Railway crossing Road **Level Crossing** **Road crossing Railway**
Railway crossing River or Canal **Road over single stream** **Road over River or Canal**
County Boundary (Geographical)
County & Civil Parish Boundary
Administrative County & Civil Parish Boundary
County Borough Boundary (England)
County Burgh Boundary (Scotland)
Co. Boro. Bdy.
Co. Burgh Bdy.
BP BS Boundary Post or Stone **P.C.B** Police Call Box
B.R. Bridle Road **P** Pump
E.P Electricity Pylon **S.P** Signal Post
F.B. Foot Bridge **SL** Sluice
F.P. Foot Path **Sp.** Spring
G.P Guide Post or Board **T.C.B** Telephone Call Box
M.S Mile Stone **Tr.** Trough
M.P M.R Mooring Post or Ring **W** Well

Ordnance Survey Plan, Additional SIMs and Supply of Unpublished Survey Information 1:2,500 and 1:1,250

Inactive Quarry, Chalk Pit or Clay Pit **Active Quarry, Chalk Pit or Clay Pit**
Rock **Boulders**
Cliff **Slopes** **Top**
Roofed Building **Glazed Roof Building**
Sloping Masonry **Archway**
Non-Coniferous Tree (surveyed) **Coniferous Tree (surveyed)**
Non-Coniferous Trees (not surveyed) **Coniferous Trees (not surveyed)**
Orchard Tree **Scrub** **Bracken**
Coppice, Osier **Reeds** **Marsh, Saltings**
Rough Grassland **Heath** **Culvert**
Direction of water flow **Bench Mark** **Antiquity (site of)**
Cave Entrance **Triangulation Station** **Electricity Pylon**
Electricity Transmission Line
County Boundary (Geographical)
County & Civil Parish Boundary
Civil Parish Boundary
Admin. County or County Bor. Boundary
London Borough Boundary
Symbol marking point where boundary mereing changes
BH Beer House **P** Pillar, Pole or Post
BP, BS Boundary Post or Stone **PO** Post Office
Cn, C Capstan, Crane **PC** Public Convenience
Chy Chimney **PH** Public House
D Fn Drinking Fountain **Pp** Pump
EI P Electricity Pillar or Post **SB, S Br** Signal Box or Bridge
FAP Fire Alarm Pillar **SP, SL** Signal Post or Light
FB Foot Bridge **Spr** Spring
GP Guide Post **Tk** Tank or Track
H Hydrant or Hydraulic **TCB** Telephone Call Box
LC Level Crossing **TCP** Telephone Call Post
MH Manhole **Tr** Trough
MP Mile Post or Mooring Post **Wr Pt, Wr T** Water Point, Water Tap
MS Mile Stone **W** Well
NTL Normal Tidal Limit **Wd Pp** Wind Pump

Large-Scale National Grid Data 1:2,500 and 1:1,250

Cliff **Slopes** **Top**
Rock **Rock (scattered)**
Boulders **Boulders (scattered)**
Positioned Boulder **Scree**
Non-Coniferous Tree (surveyed) **Coniferous Tree (surveyed)**
Non-Coniferous Trees (not surveyed) **Coniferous Trees (not surveyed)**
Orchard Tree **Scrub** **Bracken**
Coppice, Osier **Reeds** **Marsh, Saltings**
Rough Grassland **Heath** **Culvert**
Direction of water flow **Triangulation Station** **Antiquity (site of)**
Electricity Transmission Line **Electricity Pylon**
BM 231.60m Bench Mark **Buildings with Building Seed**
Roofed Building **Glazed Roof Building**
Civil parish/community boundary
District boundary
County boundary
Boundary post/stone
Boundary mereing symbol (note: these always appear in opposed pairs or groups of three)
Bks Barracks **P** Pillar, Pole or Post
Bty Battery **PO** Post Office
Cemy Cemetery **PC** Public Convenience
Chy Chimney **Pp** Pump
Cis Cistern **Ppg Sta** Pumping Station
Dismtd Rly Dismantled Railway **PW** Place of Worship
EI Gen Sta Electricity Generating Station **Sewage Ppg Sta** Sewage Pumping Station
EI P Electricity Pole, Pillar **SB, S Br** Signal Box or Bridge
EI Sub Sta Electricity Sub Station **SP, SL** Signal Post or Light
FB Filter Bed **Spr** Spring
Fn / D Fn Fountain / Drinking Ftn. **Tk** Tank or Track
Gas Gov Gas Valve Compound **Tr** Trough
GVC Gas Governor **Wd Pp** Wind Pump
GP Guide Post **Wr Pt, Wr T** Water Point, Water Tap
MH Manhole **Wks** Works (building or area)
MP, MS Mile Post or Mile Stone **W** Well



Historical Mapping & Photography included:

Mapping Type	Scale	Date	Pg
Lincolnshire	1:2,500	1886	2
Lincolnshire	1:2,500	1906	3
Ordnance Survey Plan	1:2,500	1975	4
Large-Scale National Grid Data	1:2,500	1994	5

Historical Map - Segment A6

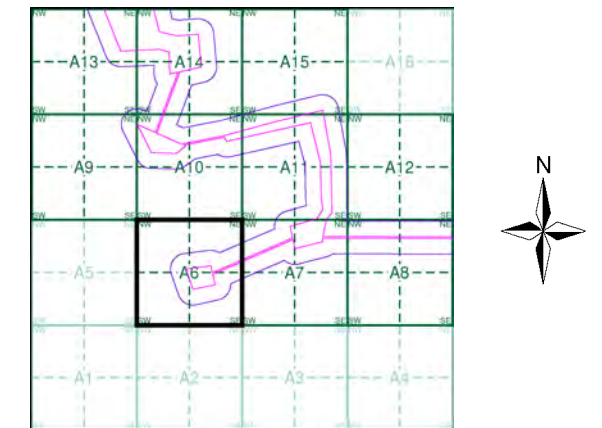

Order Details

Order Number: 297990273_1_1
 Customer Ref: 21-1088.04
 National Grid Reference: 489950, 382840
 Slice: A
 Site Area (Ha): 469.98
 Search Buffer (m): 100

Site Details

Cottam



Tel: [Redacted]
 Fax: [Redacted]
 Web: [Redacted]

Lincolnshire
Published 1886

Source map scale - 1:2,500

The historical maps shown were reproduced from maps predominantly held at the scale adopted for England, Wales and Scotland in the 1840's. In 1854 the 1:2,500 scale was adopted for mapping urban areas and by 1896 it covered the whole of what were considered to be the cultivated parts of Great Britain. The published date given below is often some years later than the surveyed date. Before 1938, all OS maps were based on the Cassini Projection, with independent surveys of a single county or group of counties, giving rise to significant inaccuracies in outlying areas.

Map Name(s) and Date(s)

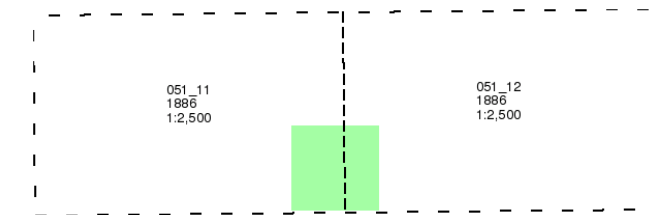

Historical Map - Segment A6

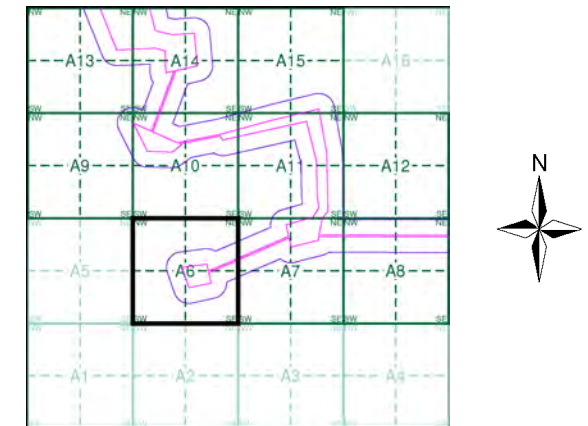

Order Details

Order Number: 297990273_1_1
 Customer Ref: 21-1088.04
 National Grid Reference: 489950, 382840
 Slice: A
 Site Area (Ha): 469.98
 Search Buffer (m): 100

Site Details

Cottam

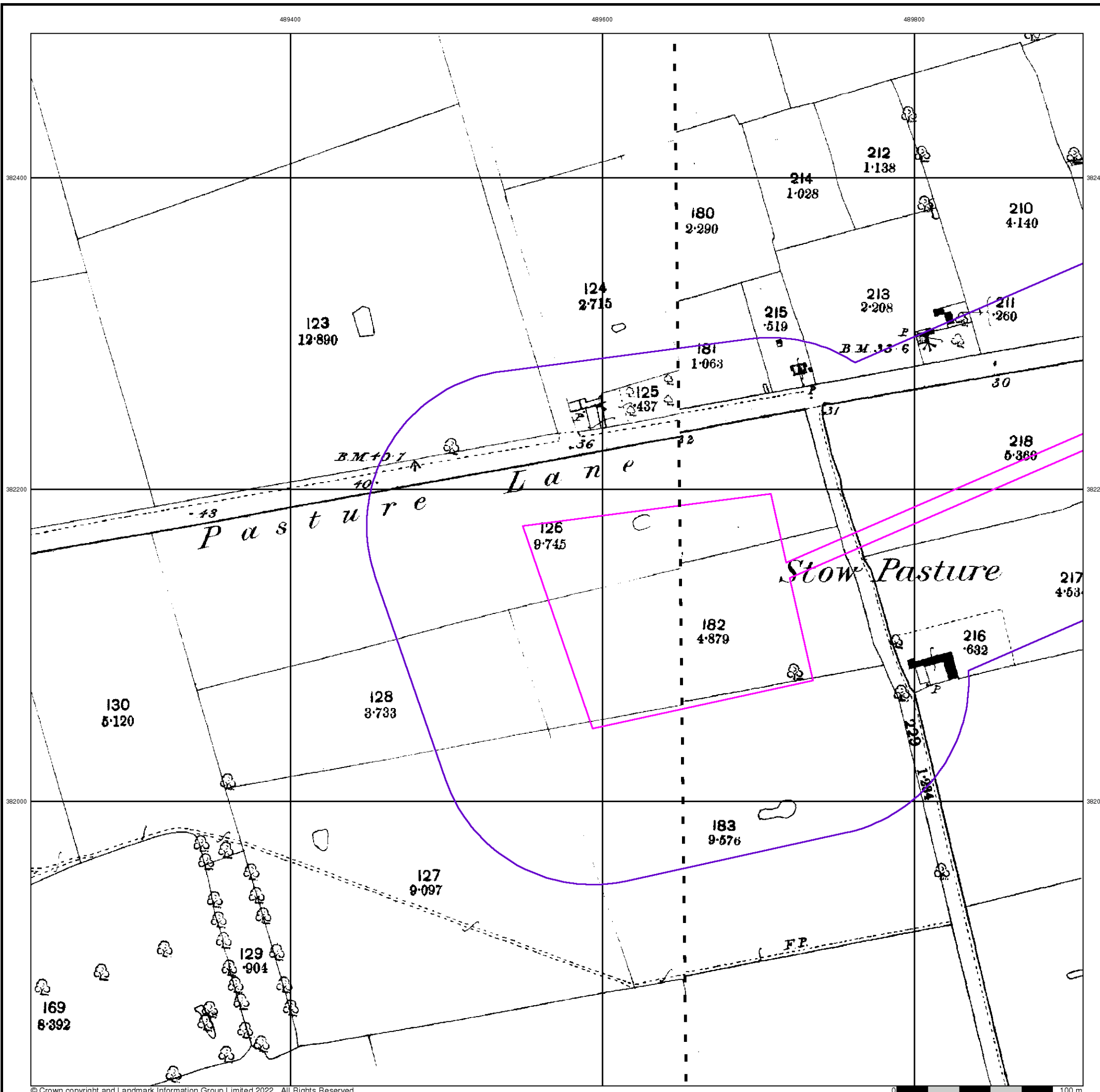

Lincolnshire
Published 1906

Source map scale - 1:2,500

The historical maps shown were reproduced from maps predominantly held at the scale adopted for England, Wales and Scotland in the 1840's. In 1854 the 1:2,500 scale was adopted for mapping urban areas and by 1896 it covered the whole of what were considered to be the cultivated parts of Great Britain. The published date given below is often some years later than the surveyed date. Before 1938, all OS maps were based on the Cassini Projection, with independent surveys of a single county or group of counties, giving rise to significant inaccuracies in outlying areas.

Map Name(s) and Date(s)

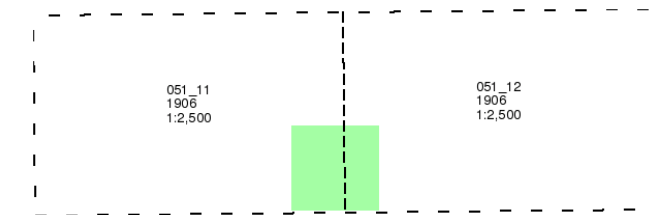

Historical Map - Segment A6

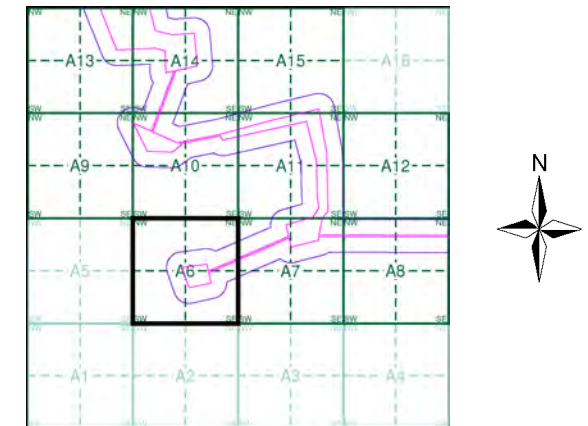

Order Details

Order Number: 297990273_1_1
 Customer Ref: 21-1088.04
 National Grid Reference: 489950, 382840
 Slice: A
 Site Area (Ha): 469.98
 Search Buffer (m): 100

Site Details

Cottam

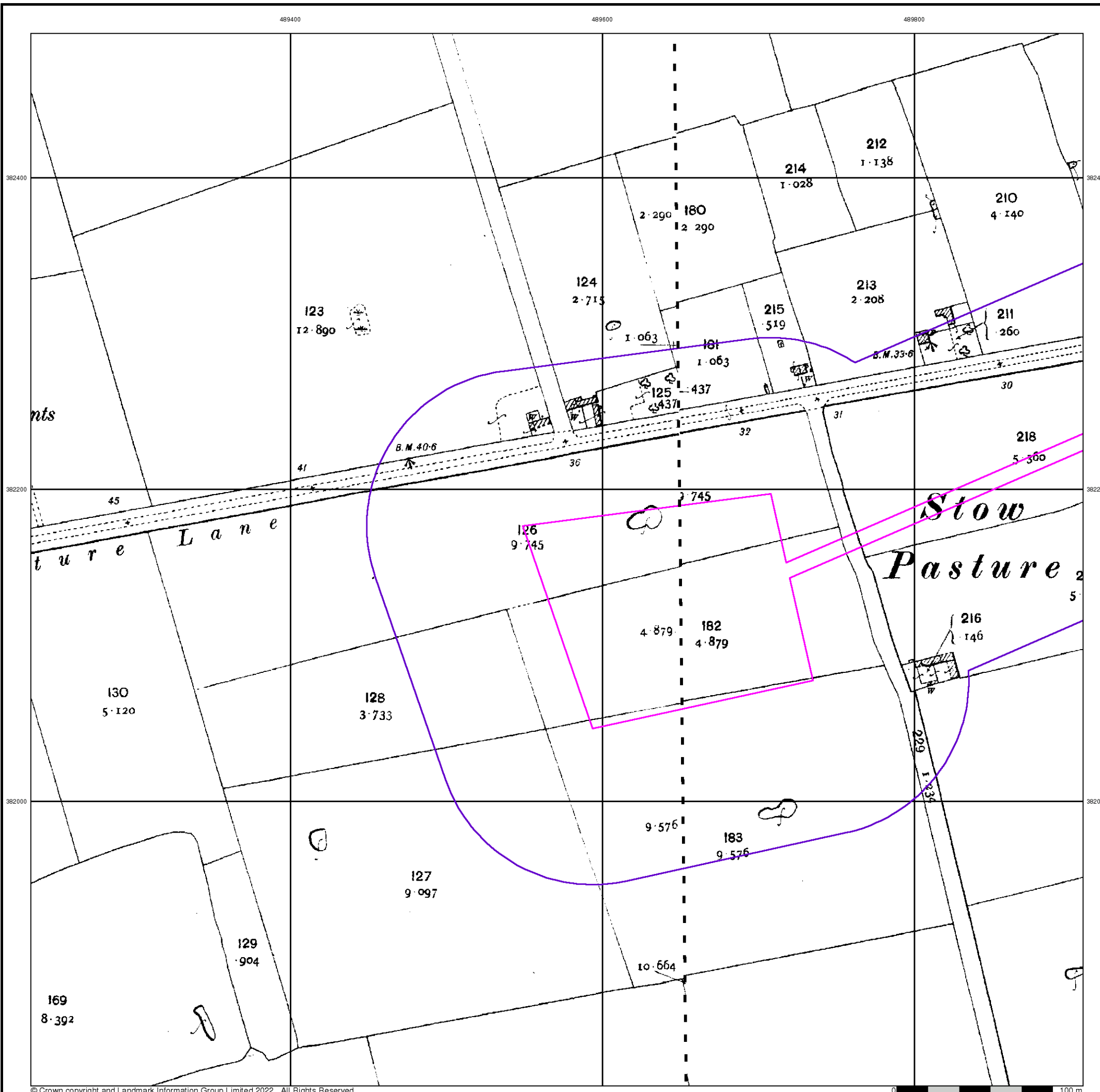

Ordnance Survey Plan

Published 1975

Source map scale - 1:2,500

The historical maps shown were reproduced from maps predominantly held at the scale adopted for England, Wales and Scotland in the 1840's. In 1854 the 1:2,500 scale was adopted for mapping urban areas and by 1896 it covered the whole of what were considered to be the cultivated parts of Great Britain. The published date given below is often some years later than the surveyed date. Before 1938, all OS maps were based on the Cassini Projection, with independent surveys of a single county or group of counties, giving rise to significant inaccuracies in outlying areas.

Map Name(s) and Date(s)

SK8982	1975	1:2,500
SK8981	1975	1:2,500

Historical Map - Segment A6

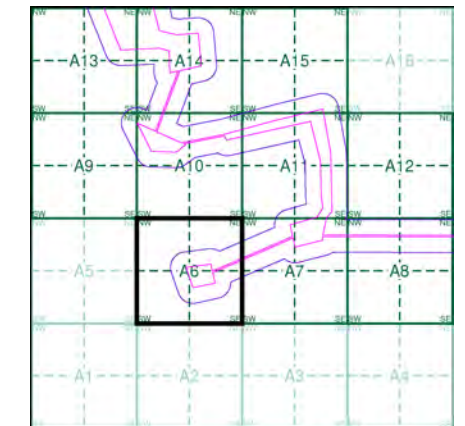

Order Details

Order Number: 297990273_1_1
 Customer Ref: 21-1088.04
 National Grid Reference: 489950, 382840
 Slice: A
 Site Area (Ha): 469.98
 Search Buffer (m): 100

Site Details

Cottam

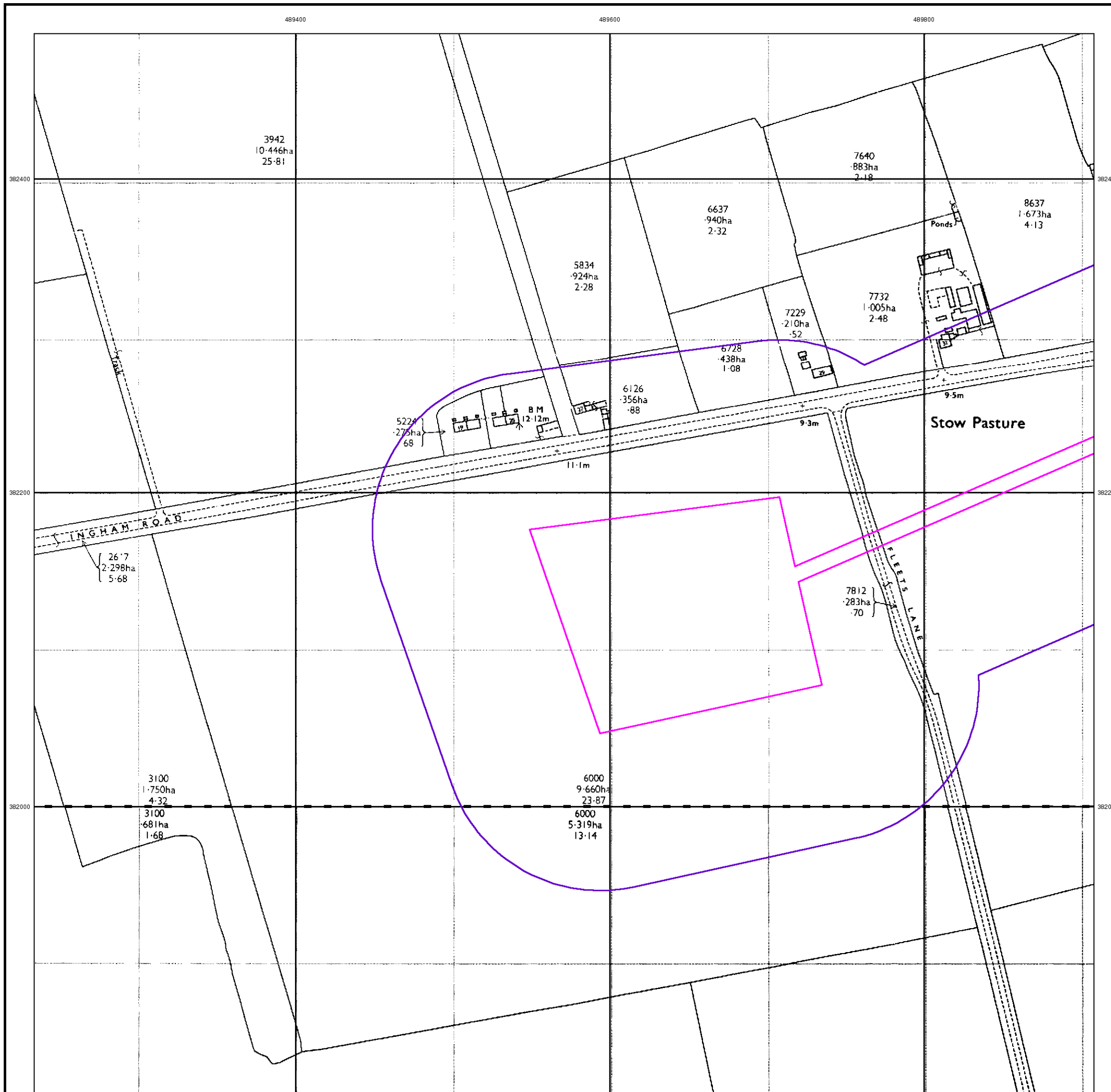

Large-Scale National Grid Data

Published 1994

Source map scale - 1:2,500

'Large Scale National Grid Data' superseded SIM cards (Ordnance Survey's 'Survey of Information on Microfilm') in 1992, and continued to be produced until 1999. These maps were the fore-runners of digital mapping and so provide detailed information on houses and roads, but tend to show less topographic features such as vegetation. These maps were produced at both 1:2,500 and 1:1,250 scales.

Map Name(s) and Date(s)

SK8982	1994	1:2,500
SK8981	1994	1:2,500

Historical Map - Segment A6

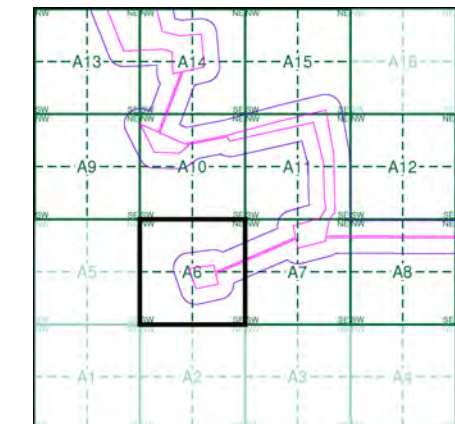

Order Details

Order Number: 297990273_1_1
 Customer Ref: 21-1088.04
 National Grid Reference: 489950, 382840
 Slice: A
 Site Area (Ha): 469.98
 Search Buffer (m): 100

Site Details

Cottam



Historical Mapping Legends

Ordnance Survey County Series and Ordnance Survey Plan 1:2,500

Quarry **Gravel Pit** **Sand Pit**
Clay Pit **Shingle** **Refuse Heap**
Sloping Masonry **Flat Rock**
Marsh **Reeds** **Osiers**
Rough Pasture **Furze** **Wood**
Mixed Wood **Brushwood** **Orchard**
Fir **Ford** **Stepping Stones**
Ferry **Waterfall** **Lock**
Trig. Station **Altitude at Trig. Station**
B.M. 325.9 **Bench Mark** **Surface Level**
Arrow denotes flow of water **Antiquities (site of)**
Cutting **Embankment**
Railway crossing Road **Level Crossing** **Road crossing Railway**
Railway crossing River or Canal **Road over single stream** **Road over River or Canal**
County Boundary (Geographical)
County & Civil Parish Boundary
Administrative County & Civil Parish Boundary
County Borough Boundary (England)
County Burgh Boundary (Scotland)
Co. Boro. Bdy.
Co. Burgh Bdy.
BP BS Boundary Post or Stone **P.C.B** Police Call Box
B.R. Bridle Road **P** Pump
E.P Electricity Pylon **S.P** Signal Post
F.B. Foot Bridge **SL** Sluice
F.P. Foot Path **Sp.** Spring
G.P Guide Post or Board **T.C.B** Telephone Call Box
M.S Mile Stone **Tr.** Trough
M.P M.R Mooring Post or Ring **W** Well

Ordnance Survey Plan, Additional SIMs and Supply of Unpublished Survey Information 1:2,500 and 1:1,250

Inactive Quarry, Chalk Pit or Clay Pit **Active Quarry, Chalk Pit or Clay Pit**
Rock **Boulders**
Cliff **Slopes** **Top**
Roofed Building **Glazed Roof Building**
Sloping Masonry **Archway**
Non-Coniferous Tree (surveyed) **Coniferous Tree (surveyed)**
Non-Coniferous Trees (not surveyed) **Coniferous Trees (not surveyed)**
Orchard Tree **Scrub** **Bracken**
Coppice, Osier **Reeds** **Marsh, Saltings**
Rough Grassland **Heath** **Culvert**
Direction of water flow **Bench Mark** **Antiquity (site of)**
Cave Entrance **Triangulation Station** **Electricity Pylon**
Electricity Transmission Line
County Boundary (Geographical)
County & Civil Parish Boundary
Civil Parish Boundary
Admin. County or County Bor. Boundary
London Borough Boundary
Symbol marking point where boundary mereing changes
BH Beer House **P** Pillar, Pole or Post
BP, BS Boundary Post or Stone **PO** Post Office
Cn, C Capstan, Crane **PC** Public Convenience
Chy Chimney **PH** Public House
D Fn Drinking Fountain **Pp** Pump
EI P Electricity Pillar or Post **SB, S Br** Signal Box or Bridge
FAP Fire Alarm Pillar **SP, SL** Signal Post or Light
FB Foot Bridge **Spr** Spring
GP Guide Post **Tk** Tank or Track
H Hydrant or Hydraulic **TCB** Telephone Call Box
LC Level Crossing **TCP** Telephone Call Post
MH Manhole **Tr** Trough
MP Mile Post or Mooring Post **Wr Pt, Wr T** Water Point, Water Tap
MS Mile Stone **W** Well
NTL Normal Tidal Limit **Wd Pp** Wind Pump

Large-Scale National Grid Data 1:2,500 and 1:1,250

Cliff **Slopes** **Top**
Rock **Rock (scattered)**
Boulders **Boulders (scattered)**
Positioned Boulder **Scree**
Non-Coniferous Tree (surveyed) **Coniferous Tree (surveyed)**
Non-Coniferous Trees (not surveyed) **Coniferous Trees (not surveyed)**
Orchard Tree **Scrub** **Bracken**
Coppice, Osier **Reeds** **Marsh, Saltings**
Rough Grassland **Heath** **Culvert**
Direction of water flow **Triangulation Station** **Antiquity (site of)**
Electricity Transmission Line **Electricity Pylon**
B.M. 231.60m Bench Mark **Buildings with Building Seed**
Roofed Building **Glazed Roof Building**
Civil parish/community boundary
District boundary
County boundary
Boundary post/stone
Boundary mereing symbol (note: these always appear in opposed pairs or groups of three)
Bks Barracks **P** Pillar, Pole or Post
Bty Battery **PO** Post Office
Cemy Cemetery **PC** Public Convenience
Chy Chimney **Pp** Pump
Cis Cistern **Ppg Sta** Pumping Station
Dismtd Rly Dismantled Railway **PW** Place of Worship
EI Gen Sta Electricity Generating Station **Sewage Ppg Sta** Sewage Pumping Station
EI P Electricity Pole, Pillar **SB, S Br** Signal Box or Bridge
EI Sub Sta Electricity Sub Station **SP, SL** Signal Post or Light
FB Filter Bed **Spr** Spring
Fn / D Fn Fountain / Drinking Ftn. **Tk** Tank or Track
Gas Gov Gas Valve Compound **Tr** Trough
GVC Gas Governor **Wd Pp** Wind Pump
GP Guide Post **Wr Pt, Wr T** Water Point, Water Tap
MH Manhole **Wks** Works (building or area)
MP, MS Mile Post or Mile Stone **W** Well



Historical Mapping & Photography included:

Mapping Type	Scale	Date	Pg
Lincolnshire	1:2,500	1886	2
Lincolnshire	1:2,500	1906	3
Ordnance Survey Plan	1:2,500	1973 - 1975	4
Large-Scale National Grid Data	1:2,500	1994	5

Historical Map - Segment A7

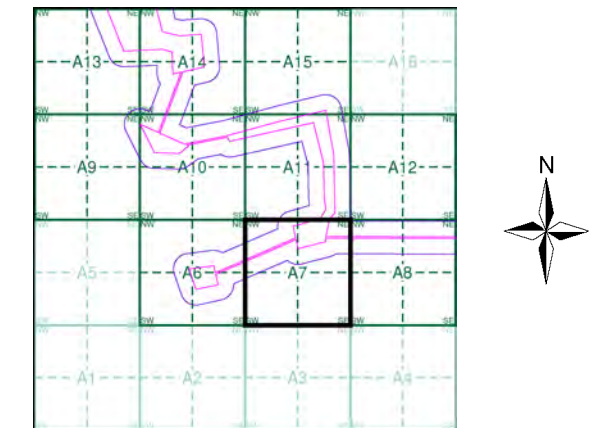

Order Details

Order Number: 297990273_1_1
 Customer Ref: 21-1088.04
 National Grid Reference: 489950, 382840
 Slice: A
 Site Area (Ha): 469.98
 Search Buffer (m): 100

Site Details

Cottam



Tel: [Redacted]
 Fax: [Redacted]
 Web: [Redacted]

Lincolnshire
Published 1886

Source map scale - 1:2,500

The historical maps shown were reproduced from maps predominantly held at the scale adopted for England, Wales and Scotland in the 1840's. In 1854 the 1:2,500 scale was adopted for mapping urban areas and by 1896 it covered the whole of what were considered to be the cultivated parts of Great Britain. The published date given below is often some years later than the surveyed date. Before 1938, all OS maps were based on the Cassini Projection, with independent surveys of a single county or group of counties, giving rise to significant inaccuracies in outlying areas.

Map Name(s) and Date(s)

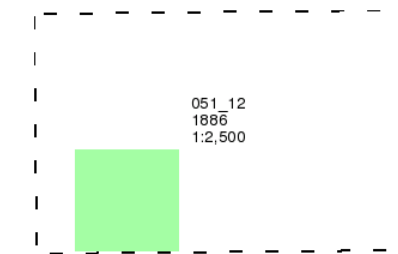

Historical Map - Segment A7

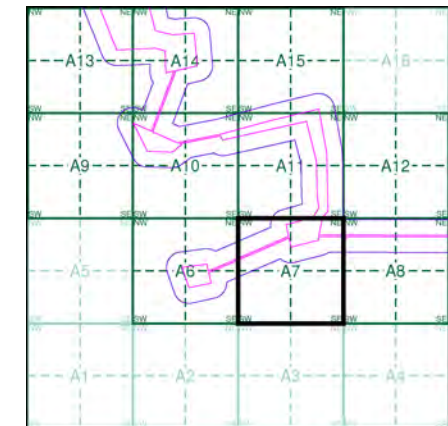

Order Details

Order Number: 297990273_1_1
 Customer Ref: 21-1088.04
 National Grid Reference: 489950, 382840
 Slice: A
 Site Area (Ha): 469.98
 Search Buffer (m): 100

Site Details

Cottam

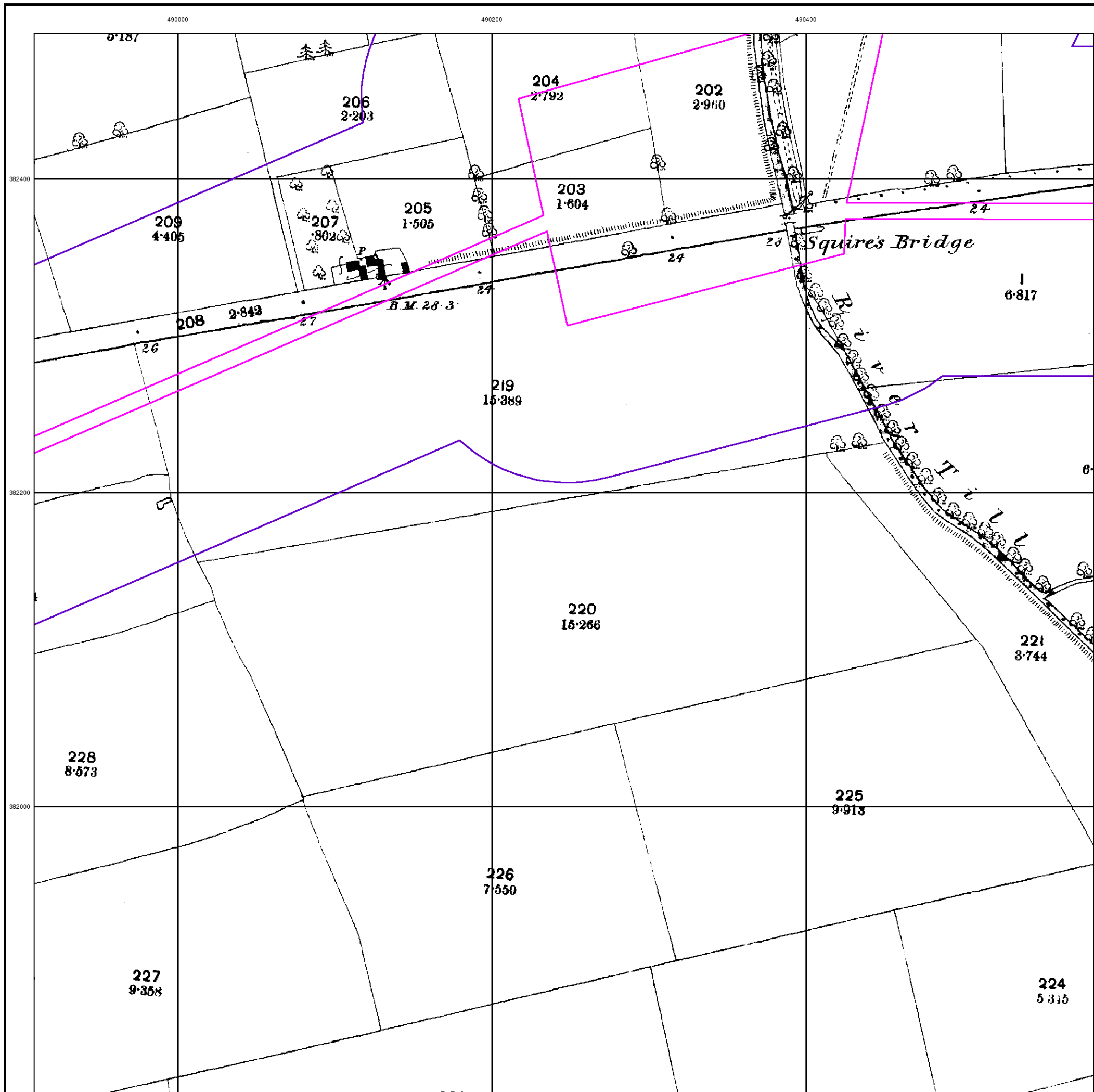

Lincolnshire
Published 1906

Source map scale - 1:2,500

The historical maps shown were reproduced from maps predominantly held at the scale adopted for England, Wales and Scotland in the 1840's. In 1854 the 1:2,500 scale was adopted for mapping urban areas and by 1896 it covered the whole of what were considered to be the cultivated parts of Great Britain. The published date given below is often some years later than the surveyed date. Before 1938, all OS maps were based on the Cassini Projection, with independent surveys of a single county or group of counties, giving rise to significant inaccuracies in outlying areas.

Map Name(s) and Date(s)

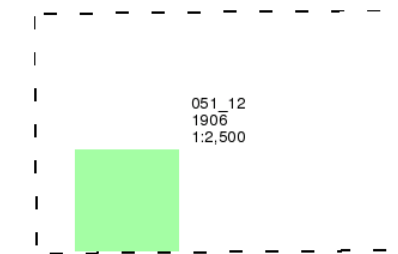

Historical Map - Segment A7

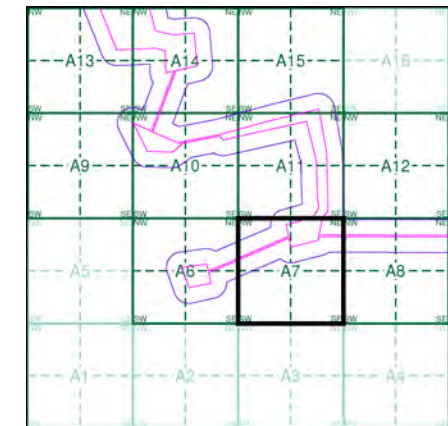

Order Details

Order Number: 297990273_1_1
 Customer Ref: 21-1088.04
 National Grid Reference: 489950, 382840
 Slice: A
 Site Area (Ha): 469.98
 Search Buffer (m): 100

Site Details

Cottam

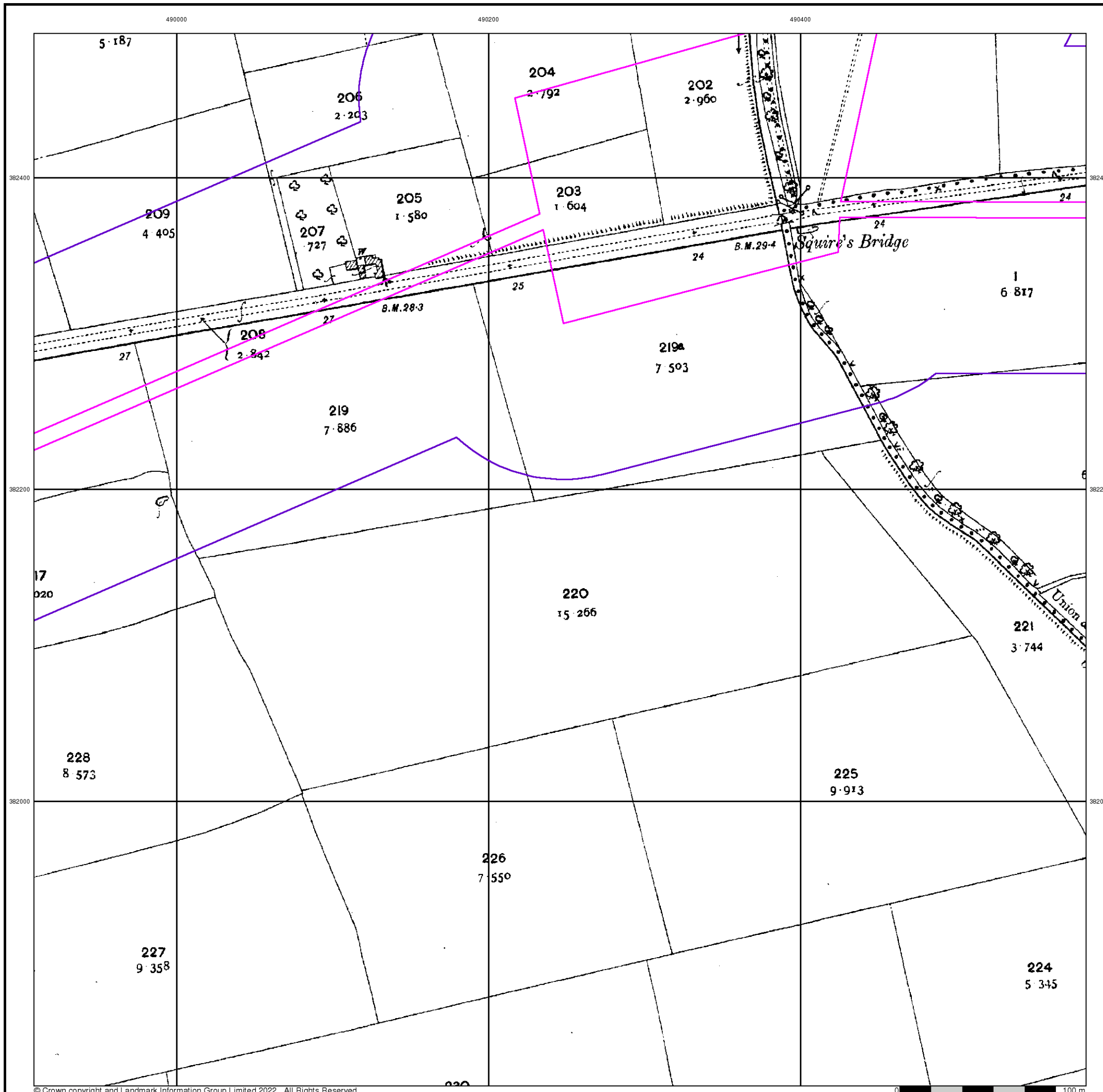

Ordnance Survey Plan
Published 1973 - 1975
Source map scale - 1:2,500

The historical maps shown were reproduced from maps predominantly held at the scale adopted for England, Wales and Scotland in the 1840's. In 1854 the 1:2,500 scale was adopted for mapping urban areas and by 1896 it covered the whole of what were considered to be the cultivated parts of Great Britain. The published date given below is often some years later than the surveyed date. Before 1938, all OS maps were based on the Cassini Projection, with independent surveys of a single county or group of counties, giving rise to significant inaccuracies in outlying areas.

Map Name(s) and Date(s)

SK8982 1975 1:2,500	SK9082 1974 1:2,500
SK8981 1975 1:2,500	SK9081 1973 1:2,500

Historical Map - Segment A7

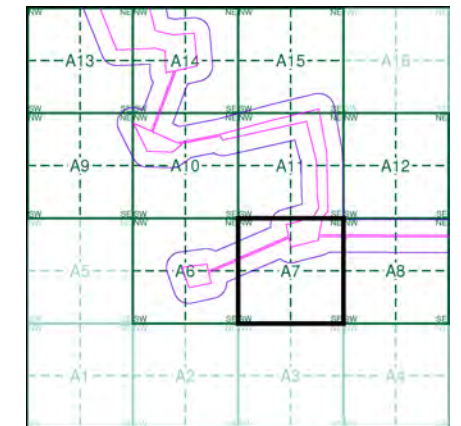

Order Details

Order Number: 297990273_1_1
 Customer Ref: 21-1088.04
 National Grid Reference: 489950, 382840
 Slice: A
 Site Area (Ha): 469.98
 Search Buffer (m): 100

Site Details

Cottam

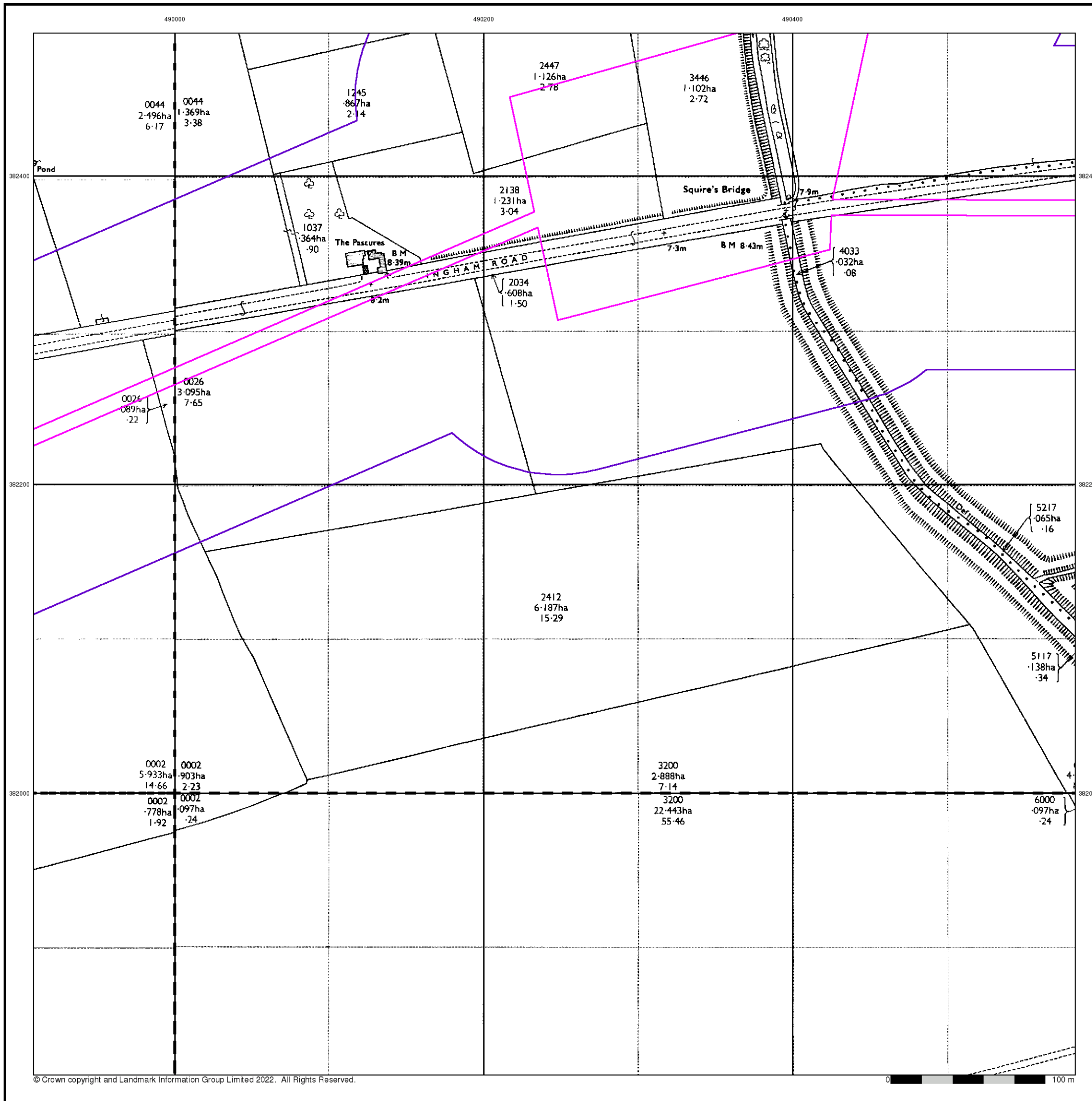

Large-Scale National Grid Data Published 1994

Source map scale - 1:2,500

'Large Scale National Grid Data' superseded SIM cards (Ordnance Survey's 'Survey of Information on Microfilm') in 1992, and continued to be produced until 1999. These maps were the fore-runners of digital mapping and so provide detailed information on houses and roads, but tend to show less topographic features such as vegetation. These maps were produced at both 1:2,500 and 1:1,250 scales.

Map Name(s) and Date(s)

SK8982 1994 1:2,500	SK9082 1994 1:2,500
SK8981 1994 1:2,500	SK9081 1994 1:2,500

Historical Map - Segment A7

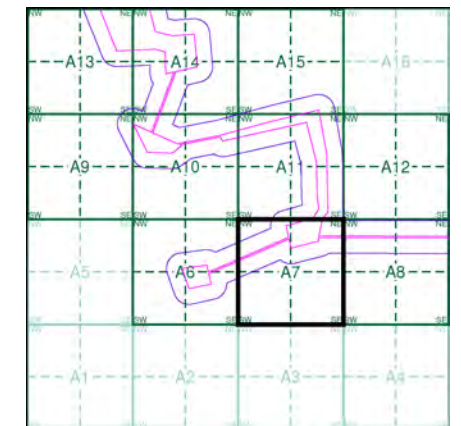

Order Details

Order Number: 297990273_1_1
 Customer Ref: 21-1088.04
 National Grid Reference: 489950, 382840
 Slice: A
 Site Area (Ha): 469.98
 Search Buffer (m): 100

Site Details

Cottam

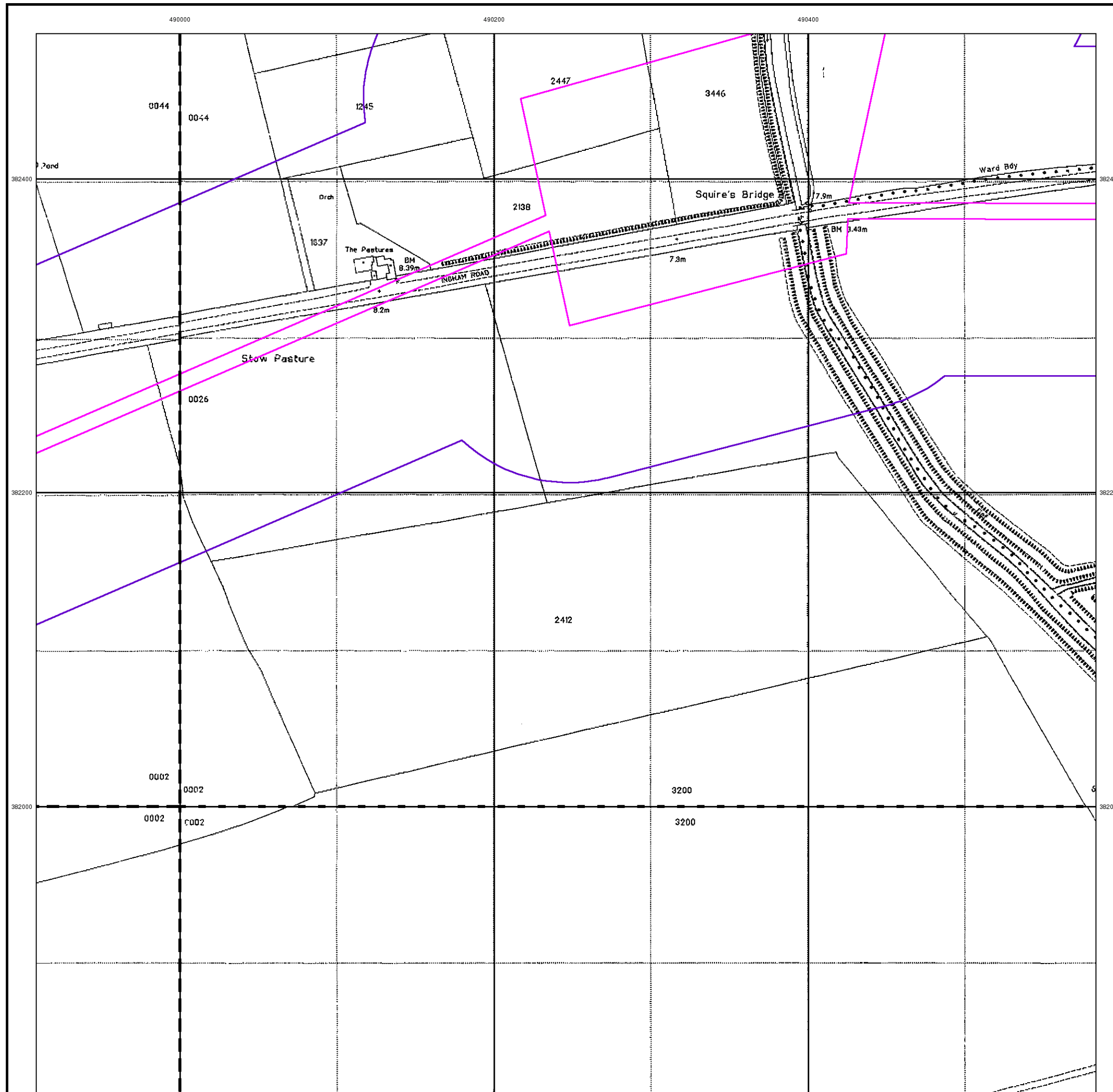

Historical Mapping Legends

Ordnance Survey County Series and Ordnance Survey Plan 1:2,500

Quarry **Gravel Pit** **Sand Pit**
Clay Pit **Shingle** **Refuse Heap**
Sloping Masonry **Flat Rock**
Marsh **Reeds** **Osiers**
Rough Pasture **Furze** **Wood**
Mixed Wood **Brushwood** **Orchard**
Fir **Ford** **Stepping Stones**
Ferry **Waterfall** **Lock**
Trig. Station **Altitude at Trig. Station**
B.M. 325.9 **Bench Mark** **Surface Level**
Arrow denotes flow of water **Antiquities (site of)**
Cutting **Embankment**
Railway crossing Road **Level Crossing** **Road crossing Railway**
Railway crossing River or Canal **Road over single stream** **Road over River or Canal**
County Boundary (Geographical)
County & Civil Parish Boundary
Administrative County & Civil Parish Boundary
County Borough Boundary (England)
County Burgh Boundary (Scotland)
Co. Boro. Bdy.
Co. Burgh Bdy.
BP BS Boundary Post or Stone **P.C.B** Police Call Box
B.R. Bridle Road **P** Pump
E.P Electricity Pylon **S.P** Signal Post
F.B. Foot Bridge **SL** Sluice
F.P. Foot Path **Sp.** Spring
G.P Guide Post or Board **T.C.B** Telephone Call Box
M.S Mile Stone **Tr.** Trough
M.P M.R Mooring Post or Ring **W** Well

Ordnance Survey Plan, Additional SIMs and Supply of Unpublished Survey Information 1:2,500 and 1:1,250

Inactive Quarry, Chalk Pit or Clay Pit **Active Quarry, Chalk Pit or Clay Pit**
Rock **Boulders**
Cliff **Slopes** **Top**
Roofed Building **Glazed Roof Building**
Sloping Masonry **Archway**
Non-Coniferous Tree (surveyed) **Coniferous Tree (surveyed)**
Non-Coniferous Trees (not surveyed) **Coniferous Trees (not surveyed)**
Orchard Tree **Scrub** **Bracken**
Coppice, Osier **Reeds** **Marsh, Saltings**
Rough Grassland **Heath** **Culvert**
Direction of water flow **Bench Mark** **Antiquity (site of)**
Cave Entrance **Triangulation Station** **Electricity Pylon**
Electricity Transmission Line
County Boundary (Geographical)
County & Civil Parish Boundary
Civil Parish Boundary
Admin. County or County Bor. Boundary
London Borough Boundary
Symbol marking point where boundary mereing changes
BH Beer House **P** Pillar, Pole or Post
BP, BS Boundary Post or Stone **PO** Post Office
Cn, C Capstan, Crane **PC** Public Convenience
Chy Chimney **PH** Public House
D Fn Drinking Fountain **Pp** Pump
EI P Electricity Pillar or Post **SB, S Br** Signal Box or Bridge
FAP Fire Alarm Pillar **SP, SL** Signal Post or Light
FB Foot Bridge **Spr** Spring
GP Guide Post **Tk** Tank or Track
H Hydrant or Hydraulic **TCB** Telephone Call Box
LC Level Crossing **TCP** Telephone Call Post
MH Manhole **Tr** Trough
MP Mile Post or Mooring Post **Wr Pt, Wr T** Water Point, Water Tap
MS Mile Stone **W** Well
NTL Normal Tidal Limit **Wd Pp** Wind Pump

Large-Scale National Grid Data 1:2,500 and 1:1,250

Cliff **Slopes** **Top**
Rock **Rock (scattered)**
Boulders **Boulders (scattered)**
Positioned Boulder **Scree**
Non-Coniferous Tree (surveyed) **Coniferous Tree (surveyed)**
Non-Coniferous Trees (not surveyed) **Coniferous Trees (not surveyed)**
Orchard Tree **Scrub** **Bracken**
Coppice, Osier **Reeds** **Marsh, Saltings**
Rough Grassland **Heath** **Culvert**
Direction of water flow **Triangulation Station** **Antiquity (site of)**
Electricity Transmission Line **Electricity Pylon**
B.M. 231.60m Bench Mark **Buildings with Building Seed**
Roofed Building **Glazed Roof Building**
Civil parish/community boundary
District boundary
County boundary
Boundary post/stone
Boundary mereing symbol (note: these always appear in opposed pairs or groups of three)
Bks Barracks **P** Pillar, Pole or Post
Bty Battery **PO** Post Office
Cemy Cemetery **PC** Public Convenience
Chy Chimney **Pp** Pump
Cis Cistern **Ppg Sta** Pumping Station
Dismtd Rly Dismantled Railway **PW** Place of Worship
EI Gen Sta Electricity Generating Station **Sewage Ppg Sta** Sewage Pumping Station
EI P Electricity Pole, Pillar **SB, S Br** Signal Box or Bridge
EI Sub Sta Electricity Sub Station **SP, SL** Signal Post or Light
FB Filter Bed **Spr** Spring
Fn / D Fn Fountain / Drinking Ftn. **Tk** Tank or Track
Gas Gov Gas Valve Compound **Tr** Trough
GVC Gas Governor **Wd Pp** Wind Pump
GP Guide Post **Wr Pt, Wr T** Water Point, Water Tap
MH Manhole **Wks** Works (building or area)
MP, MS Mile Post or Mile Stone **W** Well



Historical Mapping & Photography included:

Mapping Type	Scale	Date	Pg
Lincolnshire	1:2,500	1886	2
Lincolnshire	1:2,500	1906	3
Ordnance Survey Plan	1:2,500	1973 - 1974	4
Large-Scale National Grid Data	1:2,500	1994	5

Historical Map - Segment A8

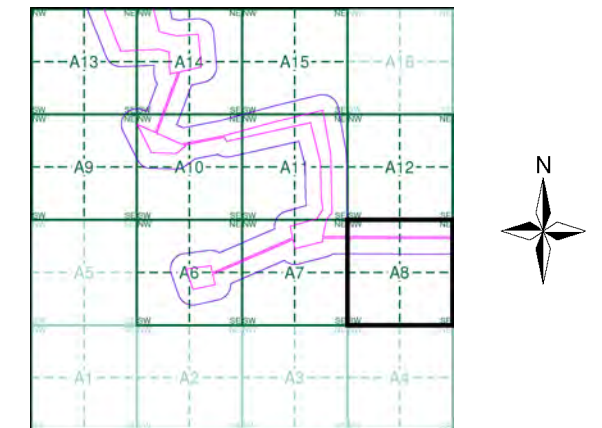

Order Details

Order Number: 297990273_1_1
 Customer Ref: 21-1088.04
 National Grid Reference: 489950, 382840
 Slice: A
 Site Area (Ha): 469.98
 Search Buffer (m): 100

Site Details

Cottam



Tel: [Redacted]
 Fax: [Redacted]
 Web: [Redacted]

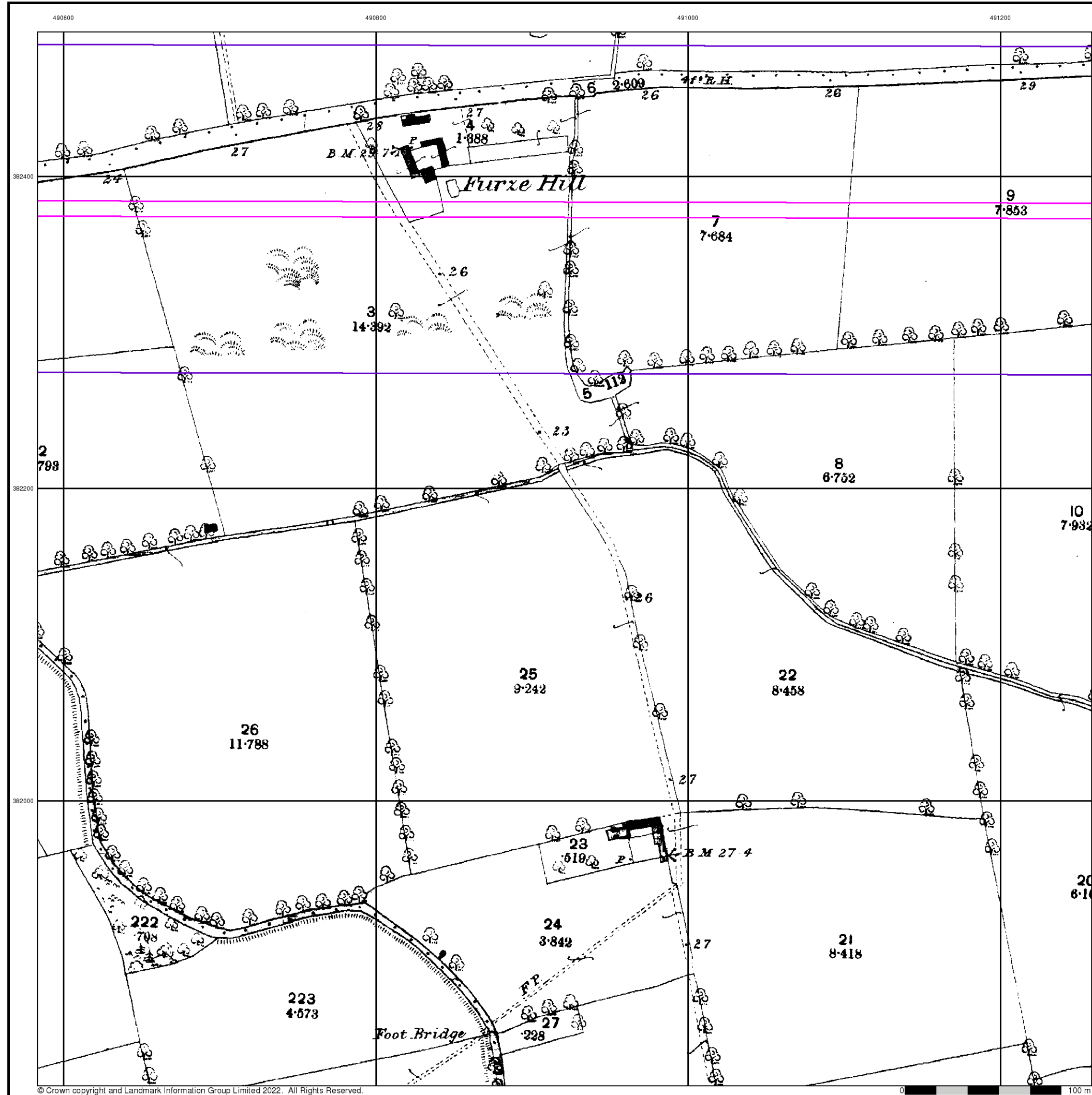

Lincolnshire
Published 1886

Source map scale - 1:2,500

The historical maps shown were reproduced from maps predominantly held at the scale adopted for England, Wales and Scotland in the 1840's. In 1854 the 1:2,500 scale was adopted for mapping urban areas and by 1896 it covered the whole of what were considered to be the cultivated parts of Great Britain. The published date given below is often some years later than the surveyed date. Before 1938, all OS maps were based on the Cassini Projection, with independent surveys of a single county or group of counties, giving rise to significant inaccuracies in outlying areas.

Map Name(s) and Date(s)

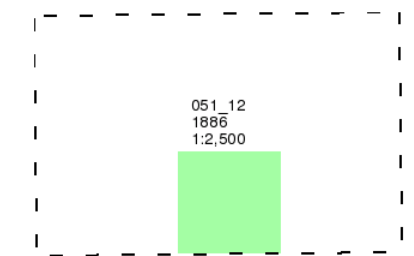

Historical Map - Segment A8

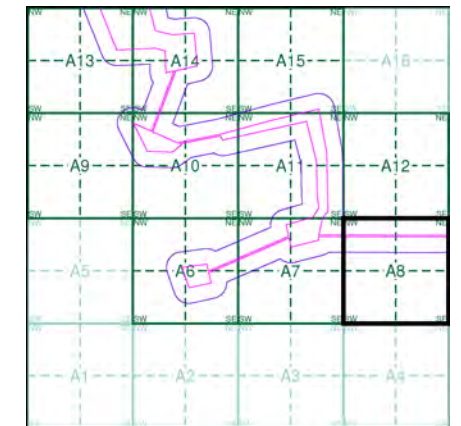

Order Details

Order Number: 297990273_1_1
 Customer Ref: 21-1088.04
 National Grid Reference: 489950, 382840
 Slice: A
 Site Area (Ha): 469.98
 Search Buffer (m): 100

Site Details

Cottam



Tel: [Redacted]
 Fax: [Redacted]
 Web: [Redacted]

Ordnance Survey Plan

Published 1973 - 1974

Source map scale - 1:2,500

The historical maps shown were reproduced from maps predominantly held at the scale adopted for England, Wales and Scotland in the 1840's. In 1854 the 1:2,500 scale was adopted for mapping urban areas and by 1896 it covered the whole of what were considered to be the cultivated parts of Great Britain. The published date given below is often some years later than the surveyed date. Before 1938, all OS maps were based on the Cassini Projection, with independent surveys of a single county or group of counties, giving rise to significant inaccuracies in outlying areas.

Map Name(s) and Date(s)

SK9082 1974 1:2,500	SK9182 1974 1:2,500
SK9081 1973 1:2,500	SK9181 1973 1:2,500

Historical Map - Segment A8

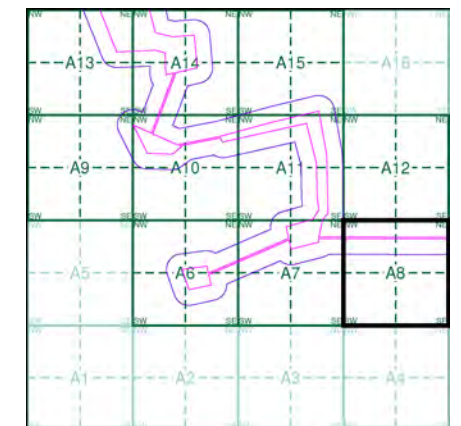

Order Details

Order Number: 297990273_1_1
 Customer Ref: 21-1088.04
 National Grid Reference: 489950, 382840
 Slice: A
 Site Area (Ha): 469.98
 Search Buffer (m): 100

Site Details

Cottam

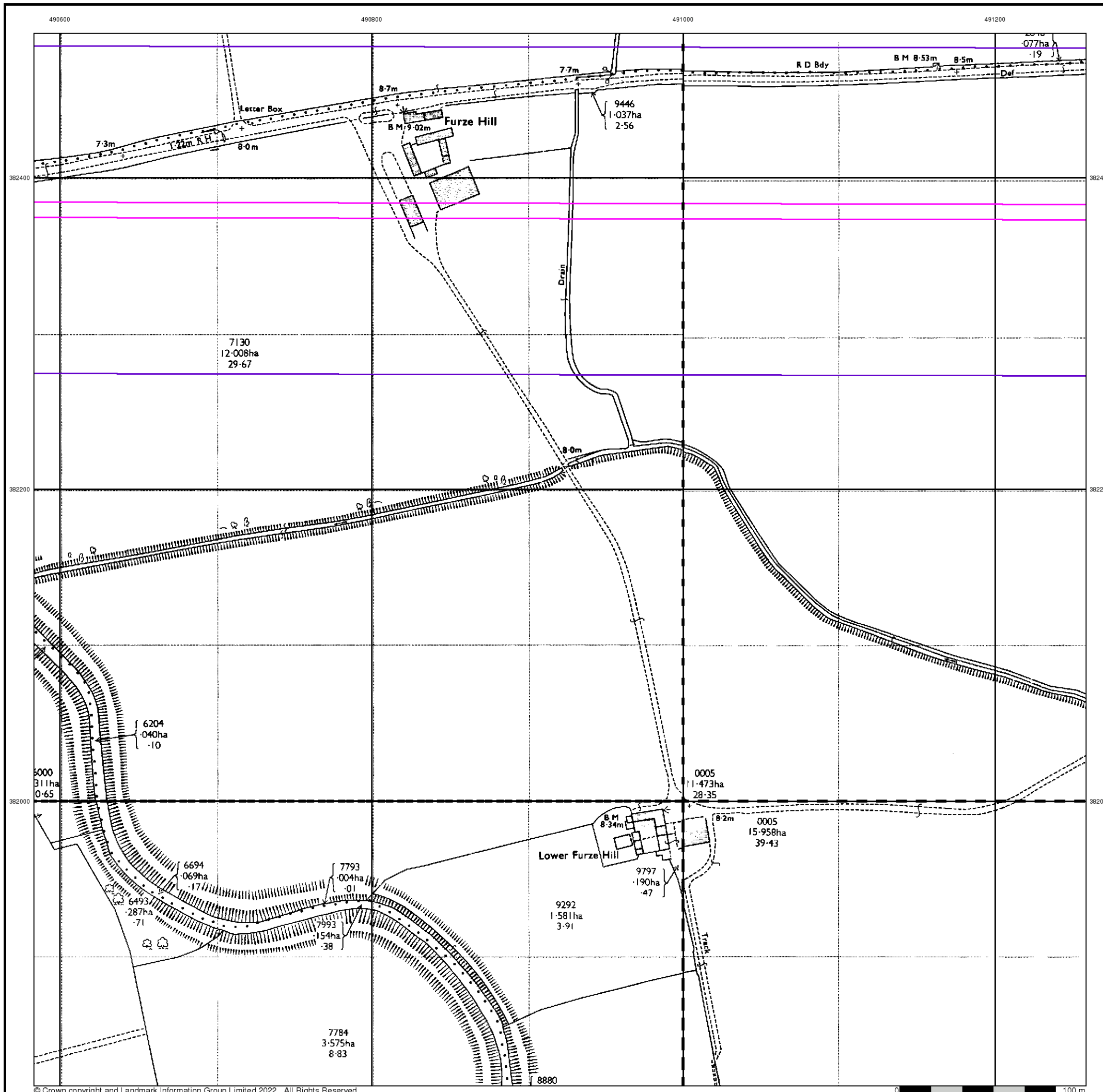

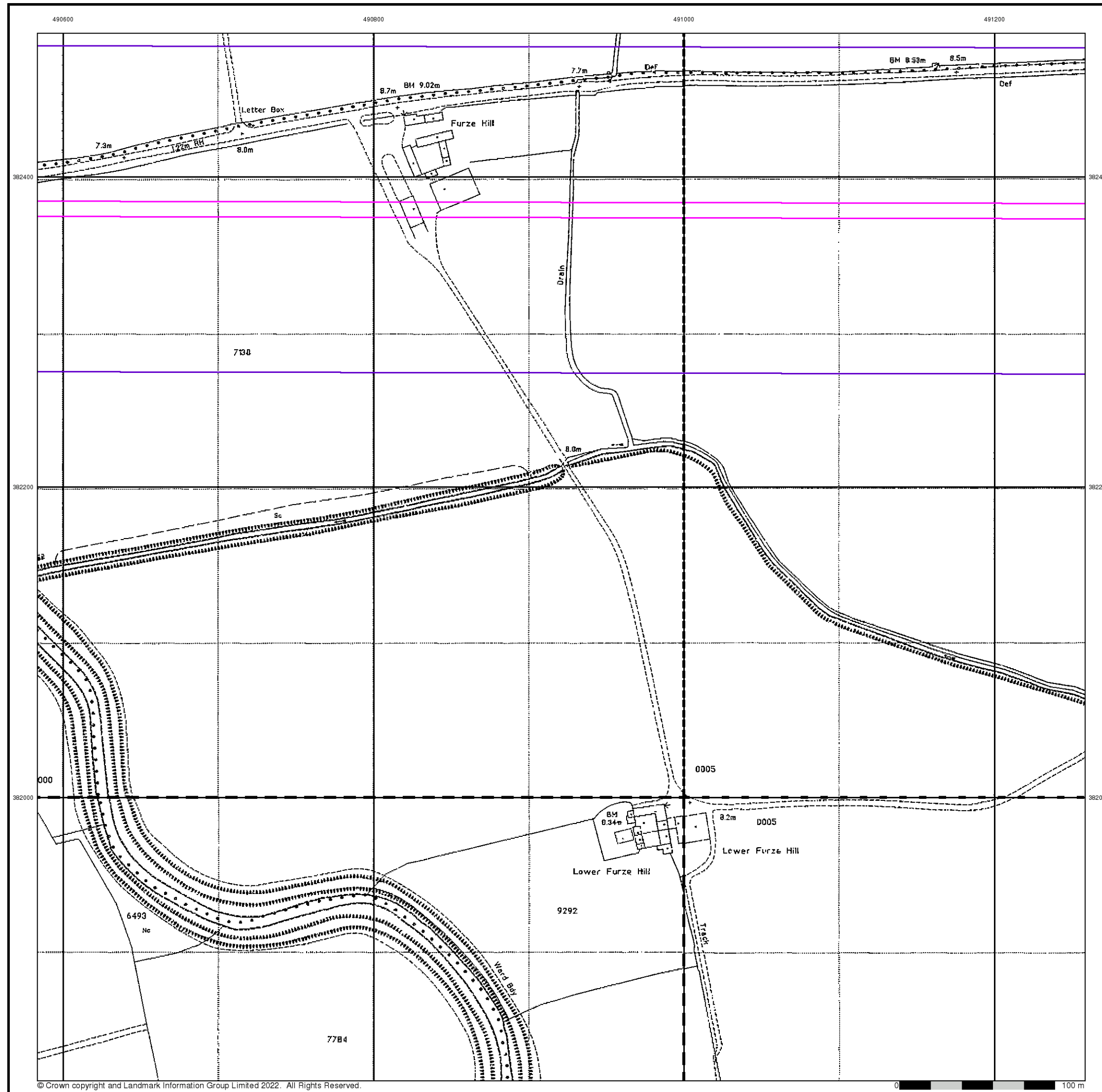

**Large-Scale National Grid Data
Published 1994
Source map scale - 1:2,500**

'Large Scale National Grid Data' superseded SIM cards (Ordnance Survey's 'Survey of Information on Microfilm') in 1992, and continued to be produced until 1999. These maps were the fore-runners of digital mapping and so provide detailed information on houses and roads, but tend to show less topographic features such as vegetation. These maps were produced at both 1:2,500 and 1:1,250 scales.

Map Name(s) and Date(s)

SK9082 1994 1:2,500	SK9182 1994 1:2,500
SK9081 1994 1:2,500	SK9181 1994 1:2,500

Historical Map - Segment A8

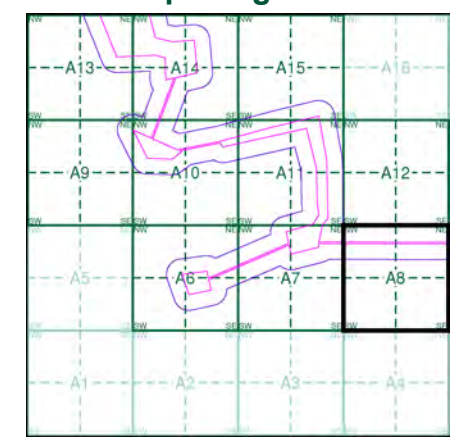

Order Details

Order Number: 297990273_1_1
 Customer Ref: 21-1088.04
 National Grid Reference: 489950, 382840
 Slice: A
 Site Area (Ha): 469.98
 Search Buffer (m): 100

Site Details

Cottam



Tel: [Redacted]
 Fax: [Redacted]
 Web: [Redacted]

Historical Mapping Legends

Ordnance Survey County Series and Ordnance Survey Plan 1:2,500

Quarry **Gravel Pit** **Sand Pit**
Clay Pit **Shingle** **Refuse Heap**
Sloping Masonry **Flat Rock**
Marsh **Reeds** **Osiers**
Rough Pasture **Furze** **Wood**
Mixed Wood **Brushwood** **Orchard**
Fir **Ford** **Stepping Stones**
Ferry **Waterfall** **Lock**
Trig. Station **Altitude at Trig. Station**
B.M. 325.9 **Bench Mark** **Surface Level**
Arrow denotes flow of water **Antiquities (site of)**
Cutting **Embankment**
Railway crossing Road **Level Crossing** **Road crossing Railway**
Railway crossing River or Canal **Road over single stream** **Road over River or Canal**
County Boundary (Geographical)
County & Civil Parish Boundary
Administrative County & Civil Parish Boundary
County Borough Boundary (England)
County Burgh Boundary (Scotland)
Co. Boro. Bdy.
Co. Burgh Bdy.
BP BS Boundary Post or Stone **P.C.B** Police Call Box
B.R. Bridle Road **P** Pump
E.P Electricity Pylon **S.P** Signal Post
F.B. Foot Bridge **SL** Sluice
F.P. Foot Path **Sp.** Spring
G.P Guide Post or Board **T.C.B** Telephone Call Box
M.S Mile Stone **Tr.** Trough
M.P M.R Mooring Post or Ring **W** Well

Ordnance Survey Plan, Additional SIMs and Supply of Unpublished Survey Information 1:2,500 and 1:1,250

Inactive Quarry, Chalk Pit or Clay Pit **Active Quarry, Chalk Pit or Clay Pit**
Rock **Boulders**
Cliff **Slopes** **Top**
Roofed Building **Glazed Roof Building**
Sloping Masonry **Archway**
Non-Coniferous Tree (surveyed) **Coniferous Tree (surveyed)**
Non-Coniferous Trees (not surveyed) **Coniferous Trees (not surveyed)**
Orchard Tree **Scrub** **Bracken**
Coppice, Osier **Reeds** **Marsh, Saltings**
Rough Grassland **Heath** **Culvert**
Direction of water flow **Bench Mark** **Antiquity (site of)**
Cave Entrance **Triangulation Station** **Electricity Pylon**
Electricity Transmission Line
County Boundary (Geographical)
County & Civil Parish Boundary
Civil Parish Boundary
Admin. County or County Bor. Boundary
London Borough Boundary
Symbol marking point where boundary mereing changes
BH Beer House **P** Pillar, Pole or Post
BP, BS Boundary Post or Stone **PO** Post Office
Cn, C Capstan, Crane **PC** Public Convenience
Chy Chimney **PH** Public House
D Fn Drinking Fountain **Pp** Pump
EI P Electricity Pillar or Post **SB, S Br** Signal Box or Bridge
FAP Fire Alarm Pillar **SP, SL** Signal Post or Light
FB Foot Bridge **Spr** Spring
GP Guide Post **Tk** Tank or Track
H Hydrant or Hydraulic **TCB** Telephone Call Box
LC Level Crossing **TCP** Telephone Call Post
MH Manhole **Tr** Trough
MP Mile Post or Mooring Post **Wr Pt, Wr T** Water Point, Water Tap
MS Mile Stone **W** Well
NTL Normal Tidal Limit **Wd Pp** Wind Pump

Large-Scale National Grid Data 1:2,500 and 1:1,250

Cliff **Slopes** **Top**
Rock **Rock (scattered)**
Boulders **Boulders (scattered)**
Positioned Boulder **Scree**
Non-Coniferous Tree (surveyed) **Coniferous Tree (surveyed)**
Non-Coniferous Trees (not surveyed) **Coniferous Trees (not surveyed)**
Orchard Tree **Scrub** **Bracken**
Coppice, Osier **Reeds** **Marsh, Saltings**
Rough Grassland **Heath** **Culvert**
Direction of water flow **Triangulation Station** **Antiquity (site of)**
Electricity Transmission Line **Electricity Pylon**
B.M. 231.60m Bench Mark **Buildings with Building Seed**
Roofed Building **Glazed Roof Building**
Civil parish/community boundary
District boundary
County boundary
Boundary post/stone
Boundary mereing symbol (note: these always appear in opposed pairs or groups of three)
Bks Barracks **P** Pillar, Pole or Post
Bty Battery **PO** Post Office
Cemy Cemetery **PC** Public Convenience
Chy Chimney **Pp** Pump
Cis Cistern **Ppg Sta** Pumping Station
Dismtd Rly Dismantled Railway **PW** Place of Worship
EI Gen Sta Electricity Generating Station **Sewage Ppg Sta** Sewage Pumping Station
EI P Electricity Pole, Pillar **SB, S Br** Signal Box or Bridge
EI Sub Sta Electricity Sub Station **SP, SL** Signal Post or Light
FB Filter Bed **Spr** Spring
Fn / D Fn Fountain / Drinking Ftn. **Tk** Tank or Track
Gas Gov Gas Valve Compound **Tr** Trough
GVC Gas Governor **Wd Pp** Wind Pump
GP Guide Post **Wr Pt, Wr T** Water Point, Water Tap
MH Manhole **Wks** Works (building or area)
MP, MS Mile Post or Mile Stone **W** Well



Historical Mapping & Photography included:

Mapping Type	Scale	Date	Pg
Lincolnshire	1:2,500	1886	2
Lincolnshire	1:2,500	1906	3
Ordnance Survey Plan	1:2,500	1975	4
Large-Scale National Grid Data	1:2,500	1994	5

Historical Map - Segment A9

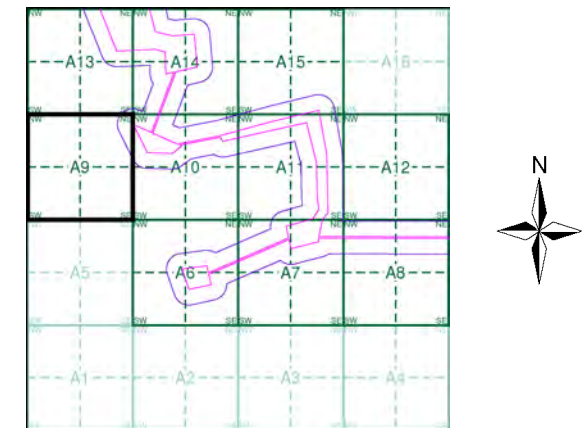

Order Details

Order Number: 297990273_1_1
 Customer Ref: 21-1088.04
 National Grid Reference: 489950, 382840
 Slice: A
 Site Area (Ha): 469.98
 Search Buffer (m): 100

Site Details

Cottam



Tel: [Redacted]
 Fax: [Redacted]
 Web: [Redacted]

Lincolnshire

Published 1886

Source map scale - 1:2,500

The historical maps shown were reproduced from maps predominantly held at the scale adopted for England, Wales and Scotland in the 1840's. In 1854 the 1:2,500 scale was adopted for mapping urban areas and by 1896 it covered the whole of what were considered to be the cultivated parts of Great Britain. The published date given below is often some years later than the surveyed date. Before 1938, all OS maps were based on the Cassini Projection, with independent surveys of a single county or group of counties, giving rise to significant inaccuracies in outlying areas.

Map Name(s) and Date(s)

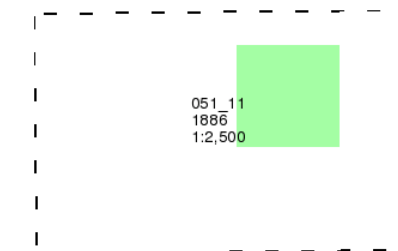

Historical Map - Segment A9

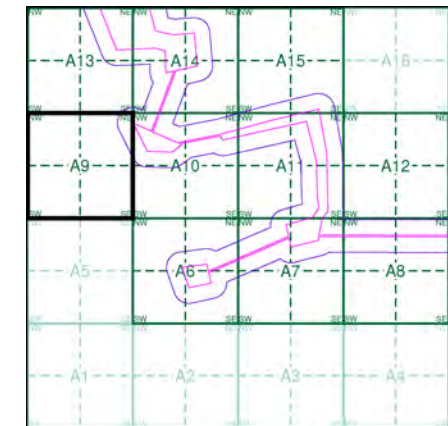

Order Details

Order Number: 297990273_1_1
 Customer Ref: 21-1088.04
 National Grid Reference: 489950, 382840
 Slice: A
 Site Area (Ha): 469.98
 Search Buffer (m): 100

Site Details

Cottam

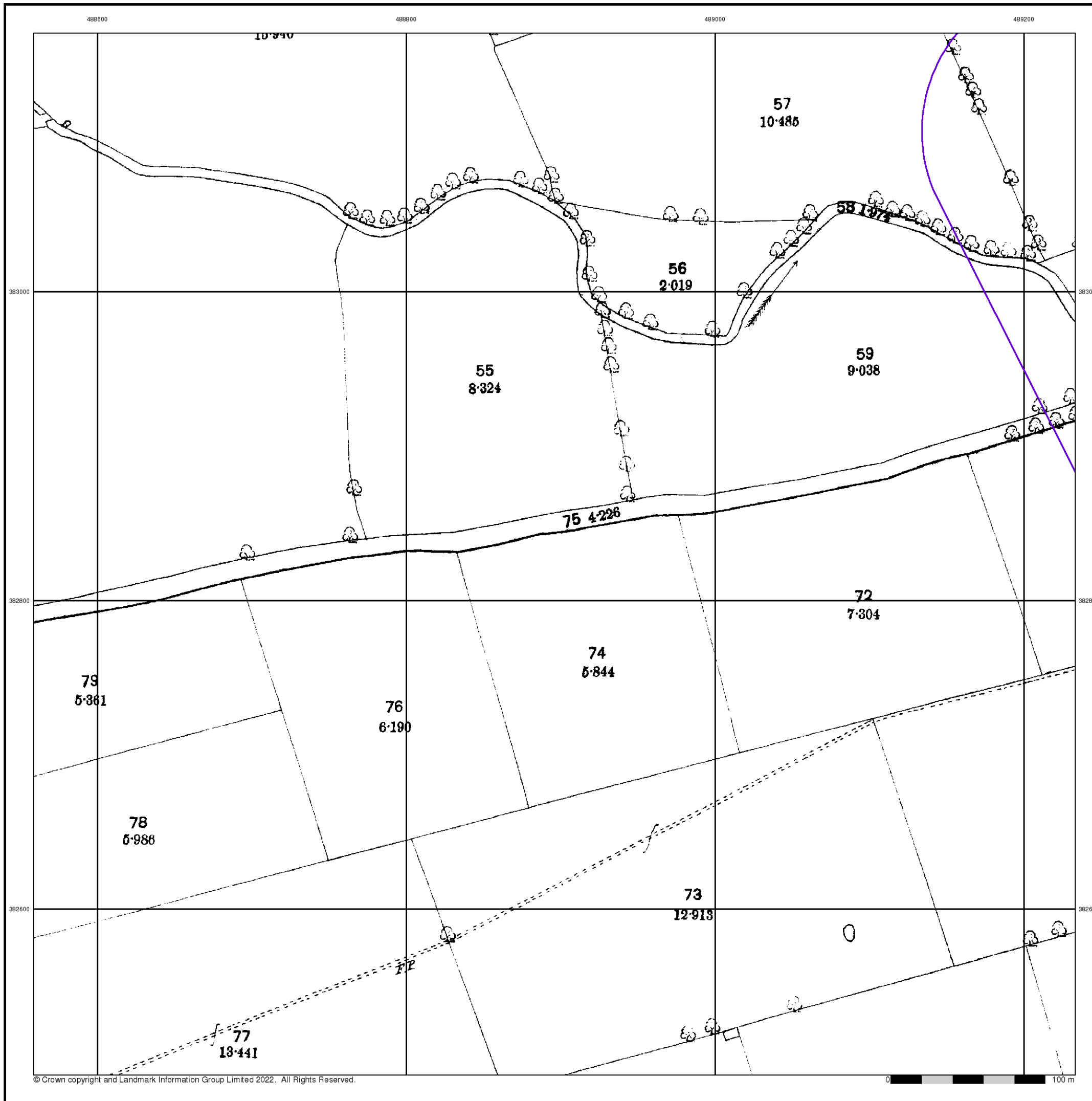

Lincolnshire

Published 1906

Source map scale - 1:2,500

The historical maps shown were reproduced from maps predominantly held at the scale adopted for England, Wales and Scotland in the 1840's. In 1854 the 1:2,500 scale was adopted for mapping urban areas and by 1896 it covered the whole of what were considered to be the cultivated parts of Great Britain. The published date given below is often some years later than the surveyed date. Before 1938, all OS maps were based on the Cassini Projection, with independent surveys of a single county or group of counties, giving rise to significant inaccuracies in outlying areas.

Map Name(s) and Date(s)

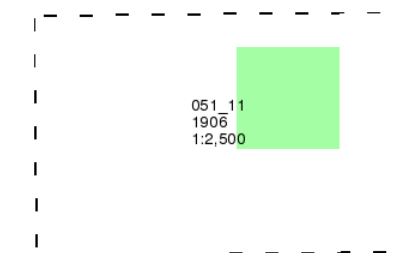

Historical Map - Segment A9

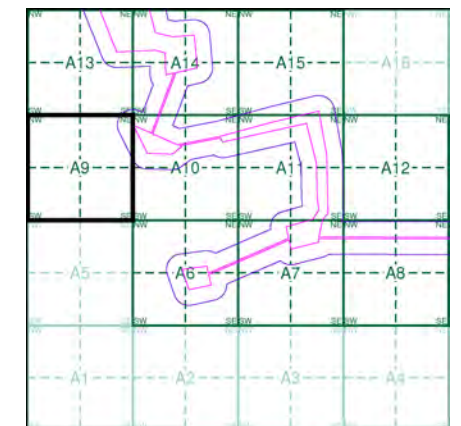

Order Details

Order Number: 297990273_1_1
 Customer Ref: 21-1088.04
 National Grid Reference: 489950, 382840
 Slice: A
 Site Area (Ha): 469.98
 Search Buffer (m): 100

Site Details

Cottam

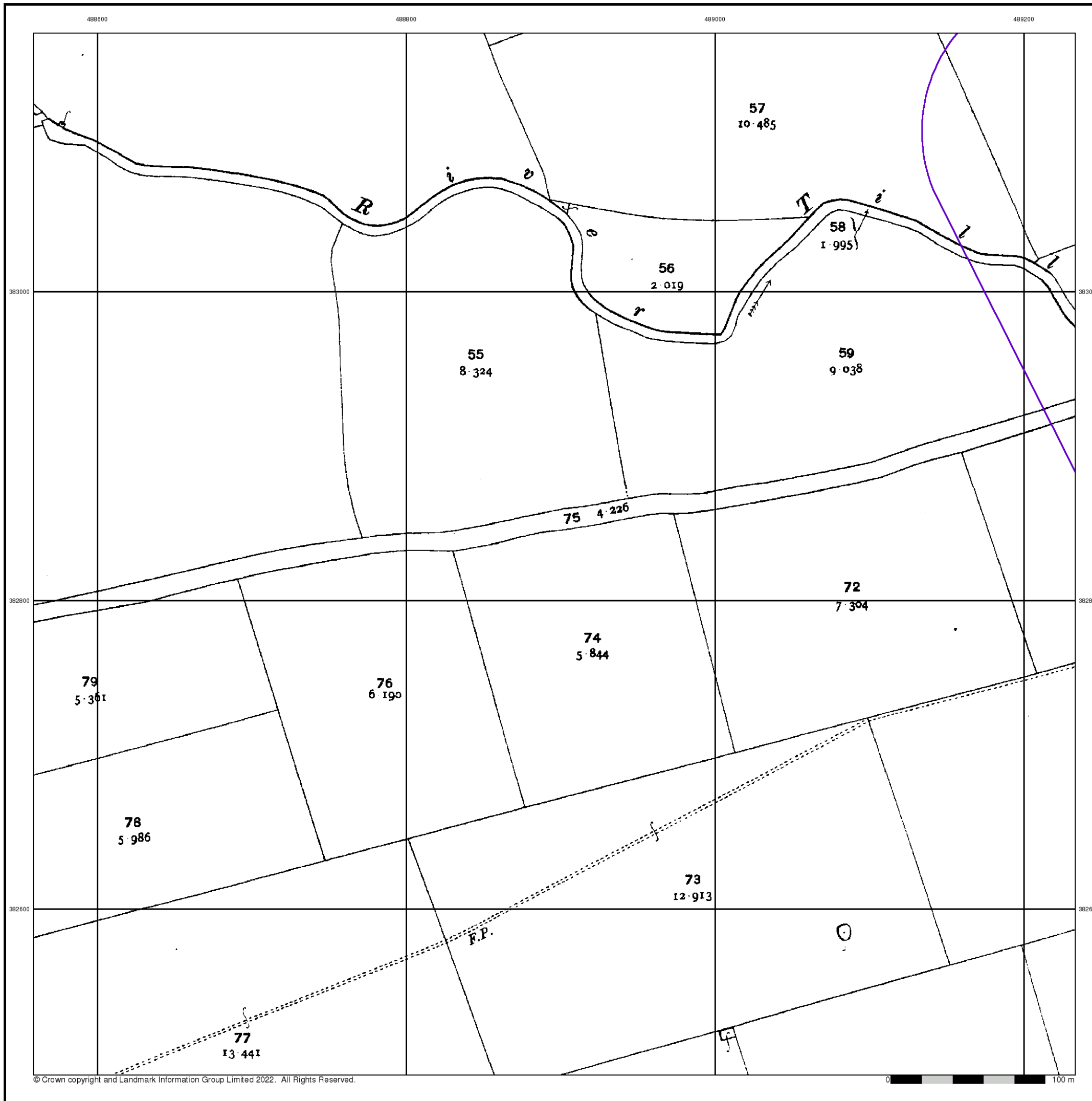

Ordnance Survey Plan

Published 1975

Source map scale - 1:2,500

The historical maps shown were reproduced from maps predominantly held at the scale adopted for England, Wales and Scotland in the 1840's. In 1854 the 1:2,500 scale was adopted for mapping urban areas and by 1896 it covered the whole of what were considered to be the cultivated parts of Great Britain. The published date given below is often some years later than the surveyed date. Before 1938, all OS maps were based on the Cassini Projection, with independent surveys of a single county or group of counties, giving rise to significant inaccuracies in outlying areas.

Map Name(s) and Date(s)

SK8883	SK8983
1975	1975
12,500	12,500
SK8882	SK8982
1975	1975
12,500	12,500

Historical Map - Segment A9

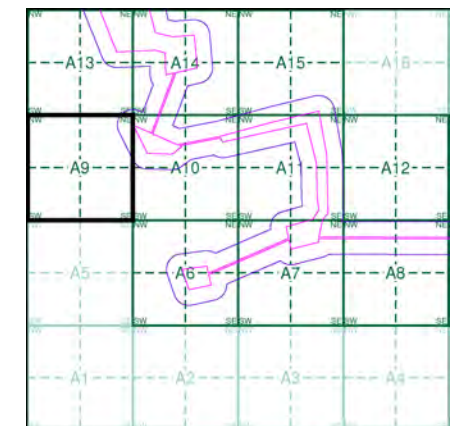

Order Details

Order Number: 297990273_1_1
 Customer Ref: 21-1088.04
 National Grid Reference: 489950, 382840
 Slice: A
 Site Area (Ha): 469.98
 Search Buffer (m): 100

Site Details

Cottam

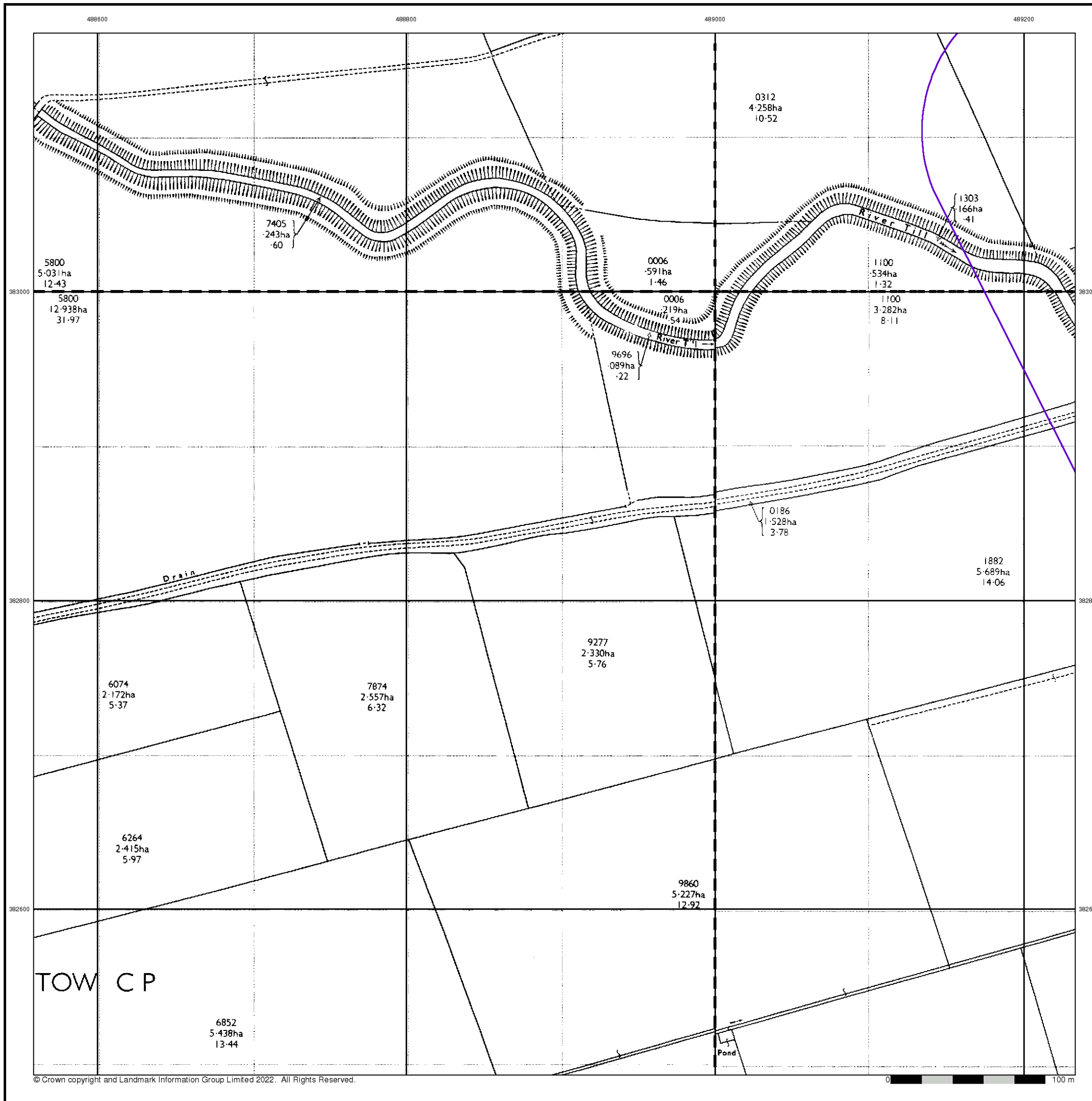

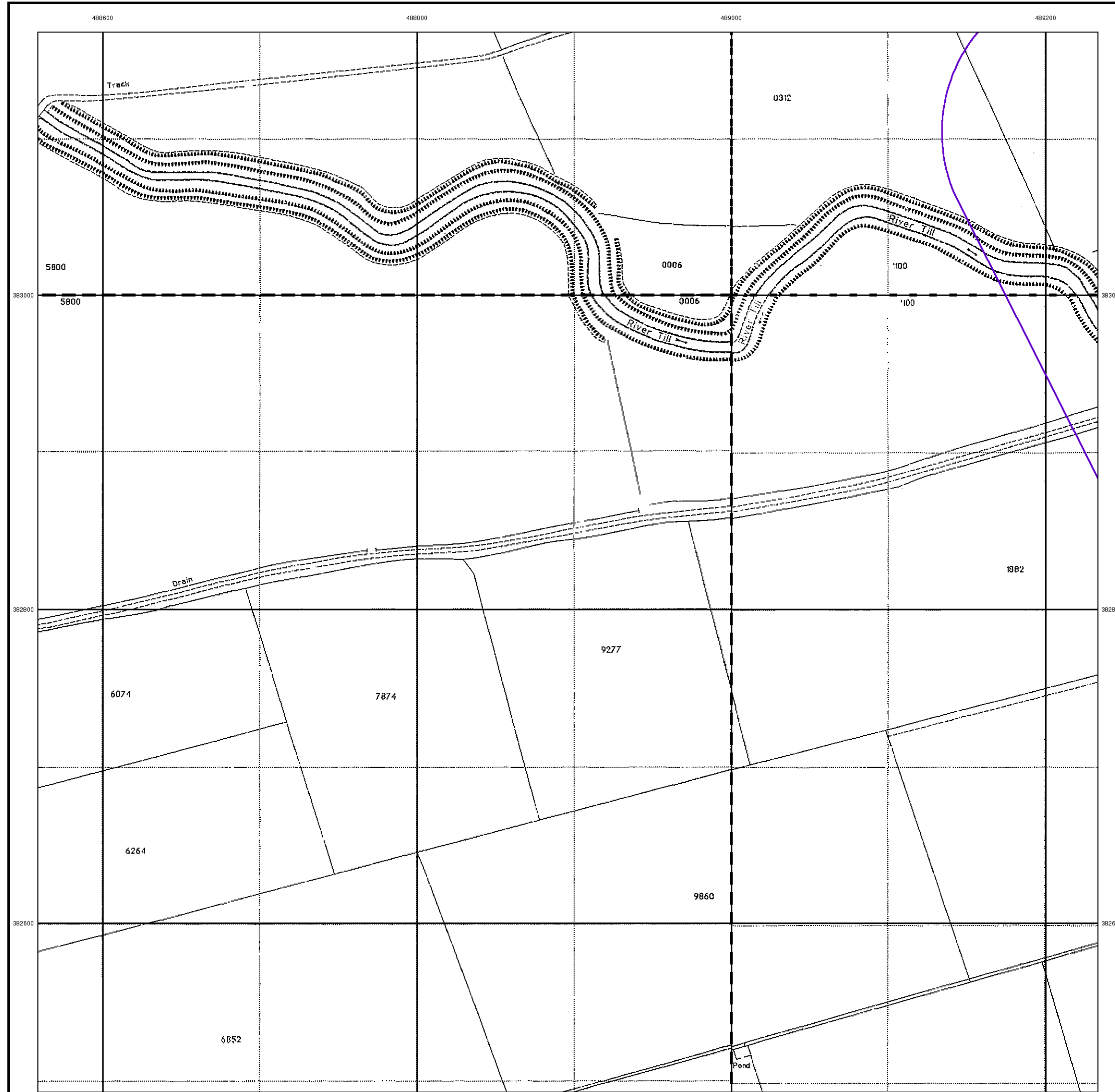

© Crown copyright and Landmark Information Group Limited 2022. All Rights Reserved.



Large-Scale National Grid Data
Published 1994
Source map scale - 1:2,500

'Large Scale National Grid Data' superseded SIM cards (Ordnance Survey's 'Survey of Information on Microfilm') in 1992, and continued to be produced until 1999. These maps were the fore-runners of digital mapping and so provide detailed information on houses and roads, but tend to show less topographic features such as vegetation. These maps were produced at both 1:2,500 and 1:1,250 scales.

Map Name(s) and Date(s)

SK8883	SK8983
1994	1994
1:2,500	1:2,500
SK8882	SK8982
1994	1994
1:2,500	1:2,500

Historical Map - Segment A9

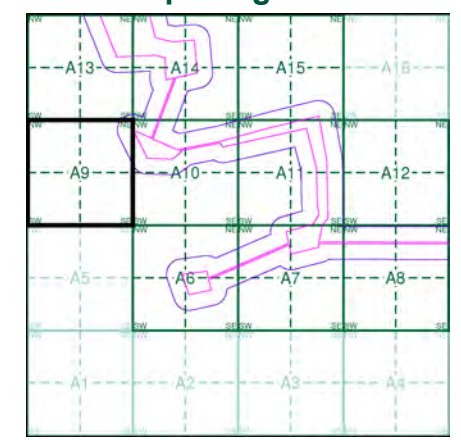

Order Details

Order Number: 297990273_1_1
 Customer Ref: 21-1088.04
 National Grid Reference: 489950, 382840
 Slice: A
 Site Area (Ha): 469.98
 Search Buffer (m): 100

Site Details

Cottam



Tel: [Redacted]
 Fax: [Redacted]
 Web: [Redacted]

Historical Mapping Legends

Ordnance Survey County Series and Ordnance Survey Plan 1:2,500

Quarry **Gravel Pit** **Sand Pit**
Clay Pit **Shingle** **Refuse Heap**
Sloping Masonry **Flat Rock**
Marsh **Reeds** **Osiers**
Rough Pasture **Furze** **Wood**
Mixed Wood **Brushwood** **Orchard**
Fir **Ford** **Stepping Stones**
Ferry **Waterfall** **Lock**
Trig. Station **Altitude at Trig. Station**
B.M. 325.9 **Bench Mark** **Surface Level**
Arrow denotes flow of water **Antiquities (site of)**
Cutting **Embankment**
Railway crossing Road **Level Crossing** **Road crossing Railway**
Railway crossing River or Canal **Road over single stream** **Road over River or Canal**
County Boundary (Geographical)
County & Civil Parish Boundary
Administrative County & Civil Parish Boundary
County Borough Boundary (England)
Co. Boro. Bdy.
County Burgh Boundary (Scotland)
Boundary Post or Stone **Police Call Box**
B.R. **Bridle Road** **P** **Pump**
E.P. **Electricity Pylon** **S.P.** **Signal Post**
F.B. **Foot Bridge** **Sl.** **Sluice**
F.P. **Foot Path** **Sp.** **Spring**
G.P. **Guide Post or Board** **T.C.B.** **Telephone Call Box**
M.S. **Mile Stone** **Tr.** **Trough**
M.P. M.R. **Mooring Post or Ring** **W** **Well**

Ordnance Survey Plan, Additional SIMs and Supply of Unpublished Survey Information 1:2,500 and 1:1,250

Inactive Quarry, Chalk Pit or Clay Pit **Active Quarry, Chalk Pit or Clay Pit**
Rock **Boulders**
Cliff **Slopes** **Top**
Roofed Building **Glazed Roof Building**
Sloping Masonry **Archway**
Non-Coniferous Tree (surveyed) **Coniferous Tree (surveyed)**
Non-Coniferous Trees (not surveyed) **Coniferous Trees (not surveyed)**
Orchard Tree **Scrub** **Bracken**
Coppice, Osier **Reeds** **Marsh, Saltings**
Rough Grassland **Heath** **Culvert**
Direction of water flow **Bench Mark** **Antiquity (site of)**
Cave Entrance **Triangulation Station** **Electricity Pylon**
Electricity Transmission Line
County Boundary (Geographical)
County & Civil Parish Boundary
Civil Parish Boundary
Admin. County or County Bor. Boundary
London Borough Boundary
Symbol marking point where boundary mereing changes
BH **Beer House** **P** **Pillar, Pole or Post**
BP, BS **Boundary Post or Stone** **PO** **Post Office**
Cn, C **Capstan, Crane** **PC** **Public Convenience**
Chy **Chimney** **PH** **Public House**
D Fn **Drinking Fountain** **Pp** **Pump**
EI P **Electricity Pillar or Post** **SB, S Br** **Signal Box or Bridge**
FAP **Fire Alarm Pillar** **SP, SL** **Signal Post or Light**
FB **Foot Bridge** **Spr** **Spring**
GP **Guide Post** **Tk** **Tank or Track**
H **Hydrant or Hydraulic** **TCB** **Telephone Call Box**
LC **Level Crossing** **TCP** **Telephone Call Post**
MH **Manhole** **Tr** **Trough**
MP **Mile Post or Mooring Post** **Wr Pt, Wr T** **Water Point, Water Tap**
MS **Mile Stone** **W** **Well**
NTL **Normal Tidal Limit** **Wd Pp** **Wind Pump**

Large-Scale National Grid Data 1:2,500 and 1:1,250

Cliff **Slopes** **Top**
Rock **Rock (scattered)**
Boulders **Boulders (scattered)**
Positioned Boulder **Scree**
Non-Coniferous Tree (surveyed) **Coniferous Tree (surveyed)**
Non-Coniferous Trees (not surveyed) **Coniferous Trees (not surveyed)**
Orchard Tree **Scrub** **Bracken**
Coppice, Osier **Reeds** **Marsh, Saltings**
Rough Grassland **Heath** **Culvert**
Direction of water flow **Triangulation Station** **Antiquity (site of)**
Electricity Transmission Line **Electricity Pylon**
B.M. 231.60m **Bench Mark** **Buildings with Building Seed**
Roofed Building **Glazed Roof Building**
Civil parish/community boundary
District boundary
County boundary
Boundary post/stone
Boundary mereing symbol (note: these always appear in opposed pairs or groups of three)
Bks **Barracks** **P** **Pillar, Pole or Post**
Bty **Battery** **PO** **Post Office**
Cemy **Cemetery** **PC** **Public Convenience**
Chy **Chimney** **Pp** **Pump**
Cis **Cistern** **Ppg Sta** **Pumping Station**
Dismtd Rly **Dismantled Railway** **PW** **Place of Worship**
EI Gen Sta **Electricity Generating Station** **Sewage Ppg Sta** **Sewage Pumping Station**
EI P **Electricity Pole, Pillar** **SB, S Br** **Signal Box or Bridge**
EI Sub Sta **Electricity Sub Station** **SP, SL** **Signal Post or Light**
FB **Filter Bed** **Spr** **Spring**
Fn / D Fn **Fountain / Drinking Ftn.** **Tk** **Tank or Track**
Gas Gov **Gas Valve Compound** **Tr** **Trough**
GVC **Gas Governor** **Wd Pp** **Wind Pump**
GP **Guide Post** **Wr Pt, Wr T** **Water Point, Water Tap**
MH **Manhole** **Wks** **Works (building or area)**
MP, MS **Mile Post or Mile Stone** **W** **Well**



Historical Mapping & Photography included:

Mapping Type	Scale	Date	Pg
Lincolnshire	1:2,500	1886	2
Lincolnshire	1:2,500	1906	3
Ordnance Survey Plan	1:2,500	1975	4
Large-Scale National Grid Data	1:2,500	1994	5

Historical Map - Segment A10

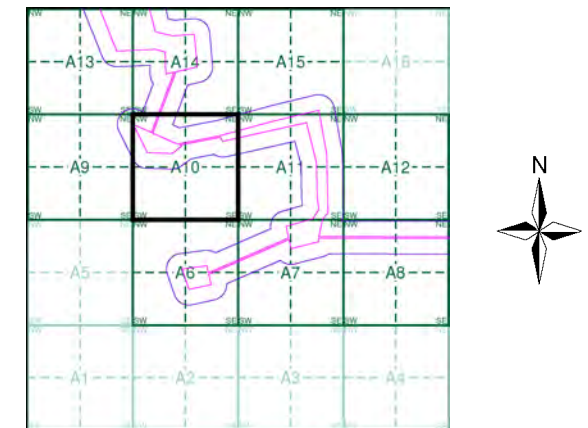

Order Details

Order Number: 297990273_1_1
 Customer Ref: 21-1088.04
 National Grid Reference: 489950, 382840
 Slice: A
 Site Area (Ha): 469.98
 Search Buffer (m): 100

Site Details

Cottam



Tel: [Redacted]
 Fax: [Redacted]
 Web: [Redacted]

Lincolnshire

Published 1886

Source map scale - 1:2,500

The historical maps shown were reproduced from maps predominantly held at the scale adopted for England, Wales and Scotland in the 1840's. In 1854 the 1:2,500 scale was adopted for mapping urban areas and by 1896 it covered the whole of what were considered to be the cultivated parts of Great Britain. The published date given below is often some years later than the surveyed date. Before 1938, all OS maps were based on the Cassini Projection, with independent surveys of a single county or group of counties, giving rise to significant inaccuracies in outlying areas.

Map Name(s) and Date(s)

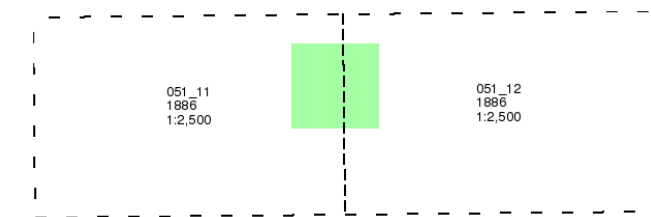

Historical Map - Segment A10

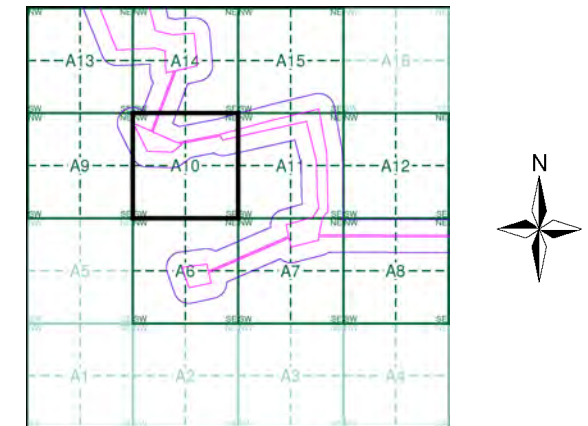

Order Details

Order Number: 297990273_1_1
 Customer Ref: 21-1088.04
 National Grid Reference: 489950, 382840
 Slice: A
 Site Area (Ha): 469.98
 Search Buffer (m): 100

Site Details

Cottam

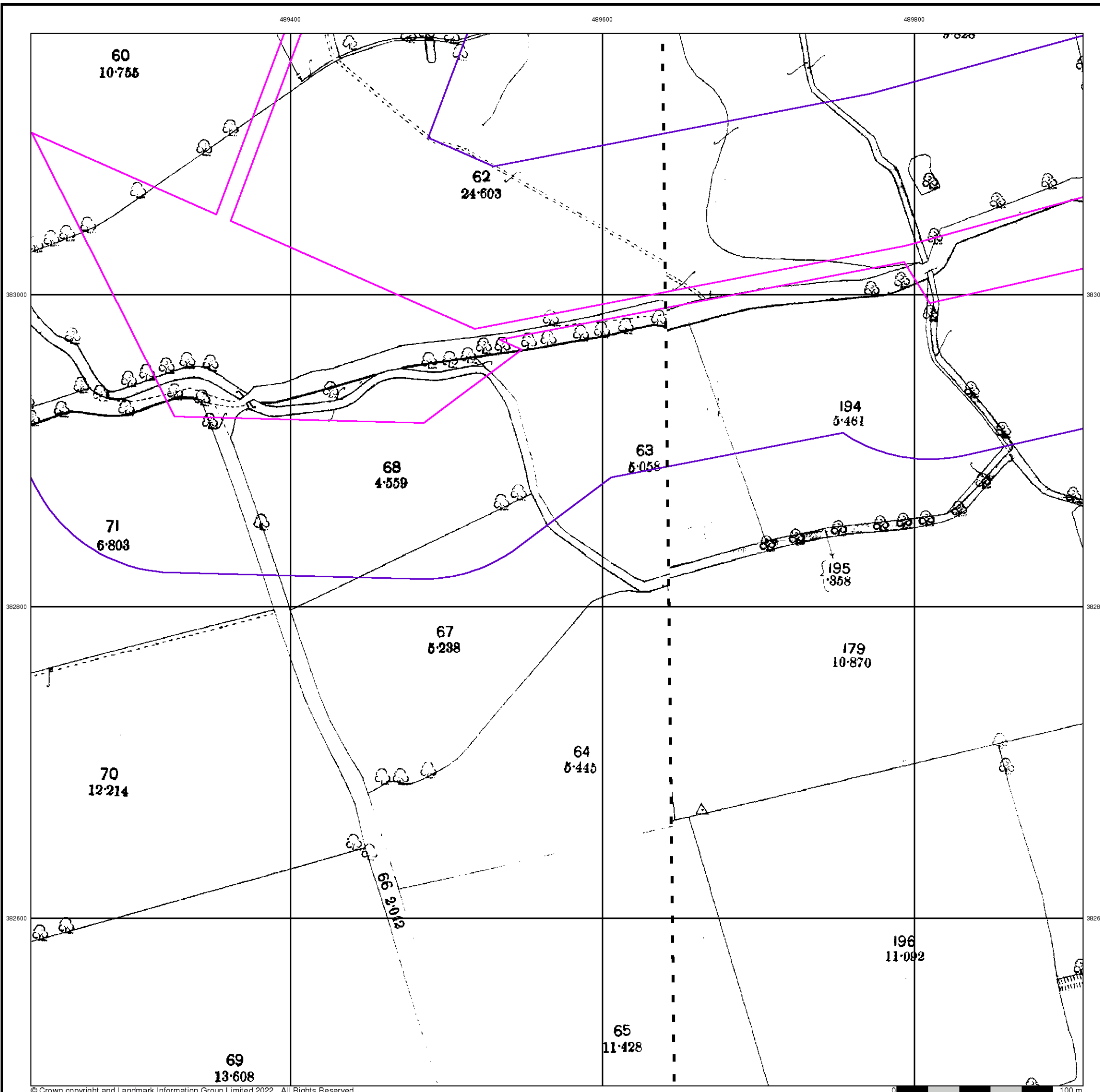

Lincolnshire

Published 1906

Source map scale - 1:2,500

The historical maps shown were reproduced from maps predominantly held at the scale adopted for England, Wales and Scotland in the 1840's. In 1854 the 1:2,500 scale was adopted for mapping urban areas and by 1896 it covered the whole of what were considered to be the cultivated parts of Great Britain. The published date given below is often some years later than the surveyed date. Before 1938, all OS maps were based on the Cassini Projection, with independent surveys of a single county or group of counties, giving rise to significant inaccuracies in outlying areas.

Map Name(s) and Date(s)

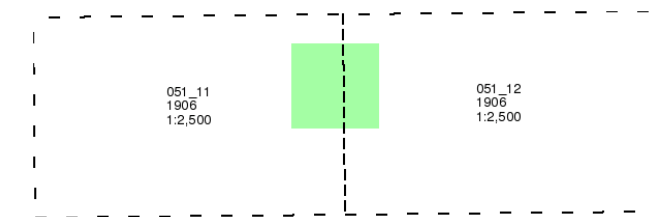

Historical Map - Segment A10

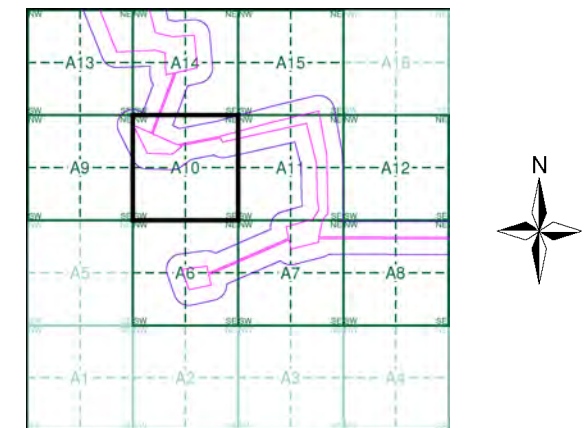

Order Details

Order Number: 297990273_1_1
 Customer Ref: 21-1088.04
 National Grid Reference: 489950, 382840
 Slice: A
 Site Area (Ha): 469.98
 Search Buffer (m): 100

Site Details

Cottam

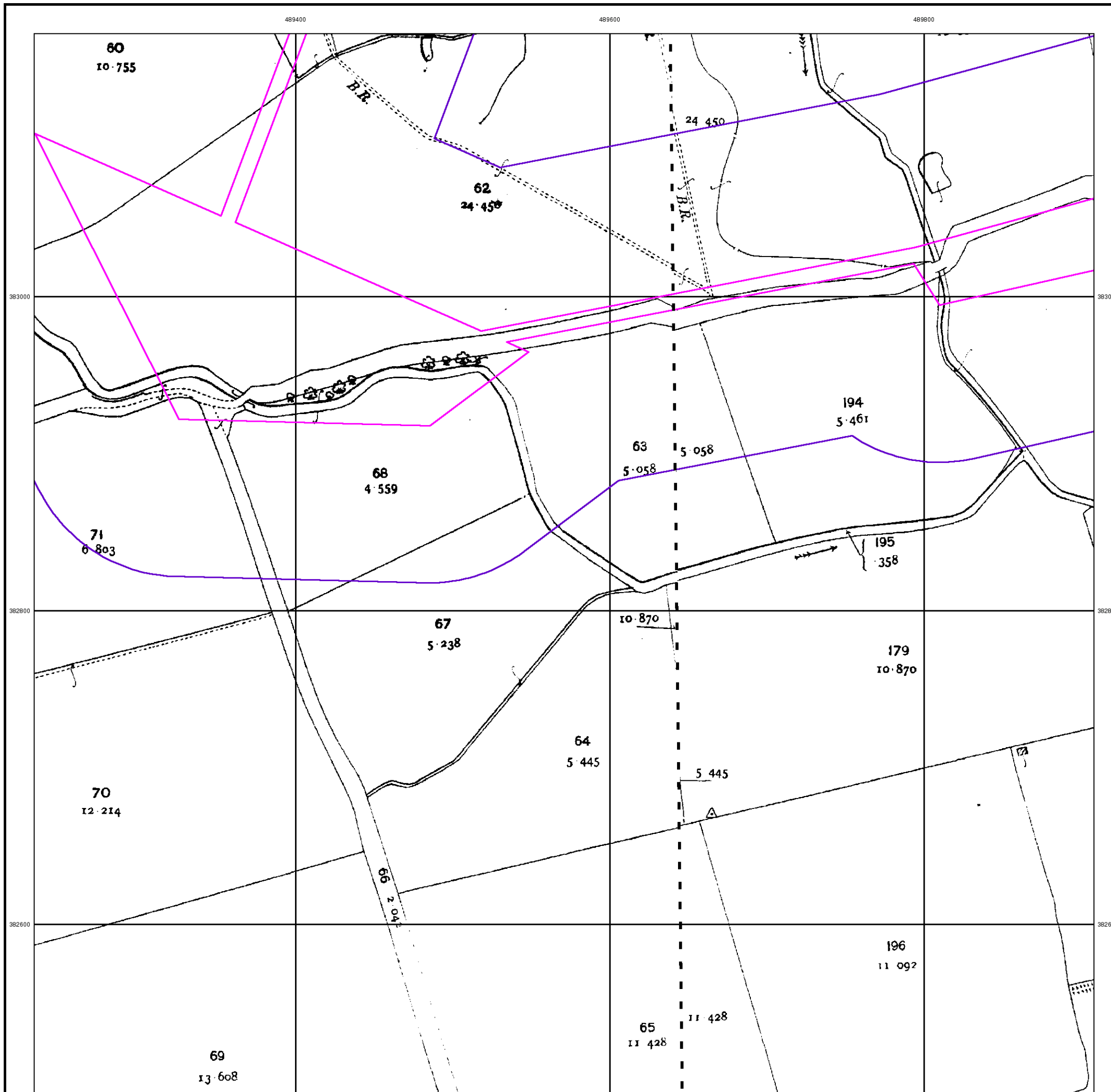

Ordnance Survey Plan

Published 1975

Source map scale - 1:2,500

The historical maps shown were reproduced from maps predominantly held at the scale adopted for England, Wales and Scotland in the 1840's. In 1854 the 1:2,500 scale was adopted for mapping urban areas and by 1896 it covered the whole of what were considered to be the cultivated parts of Great Britain. The published date given below is often some years later than the surveyed date. Before 1938, all OS maps were based on the Cassini Projection, with independent surveys of a single county or group of counties, giving rise to significant inaccuracies in outlying areas.

Map Name(s) and Date(s)

SK8983	1975	1:2,500
SK8982	1975	1:2,500

Historical Map - Segment A10

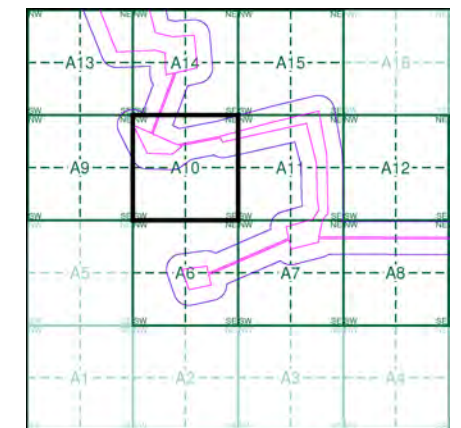

Order Details

Order Number: 297990273_1_1
 Customer Ref: 21-1088.04
 National Grid Reference: 489950, 382840
 Slice: A
 Site Area (Ha): 469.98
 Search Buffer (m): 100

Site Details

Cottam

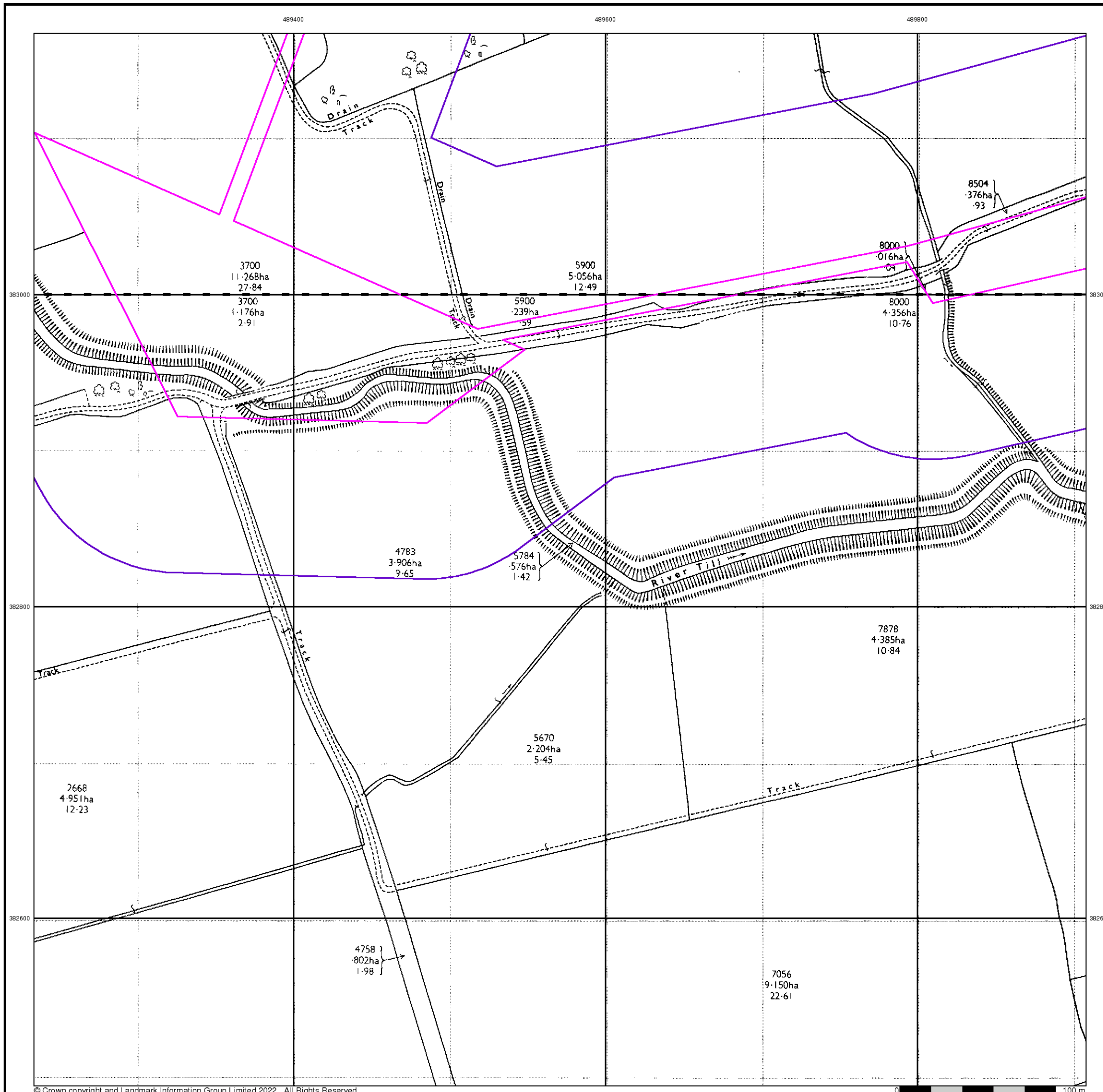

Large-Scale National Grid Data
Published 1994
Source map scale - 1:2,500

'Large Scale National Grid Data' superseded SIM cards (Ordnance Survey's 'Survey of Information on Microfilm') in 1992, and continued to be produced until 1999. These maps were the fore-runners of digital mapping and so provide detailed information on houses and roads, but tend to show less topographic features such as vegetation. These maps were produced at both 1:2,500 and 1:1,250 scales.

Map Name(s) and Date(s)

SK8983	1994	1:2,500
SK8982	1994	1:2,500

Historical Map - Segment A10

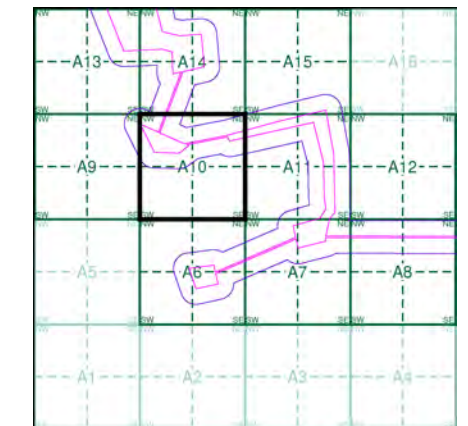

Order Details

Order Number: 297990273_1_1
 Customer Ref: 21-1088.04
 National Grid Reference: 489950, 382840
 Slice: A
 Site Area (Ha): 469.98
 Search Buffer (m): 100

Site Details

Cottam

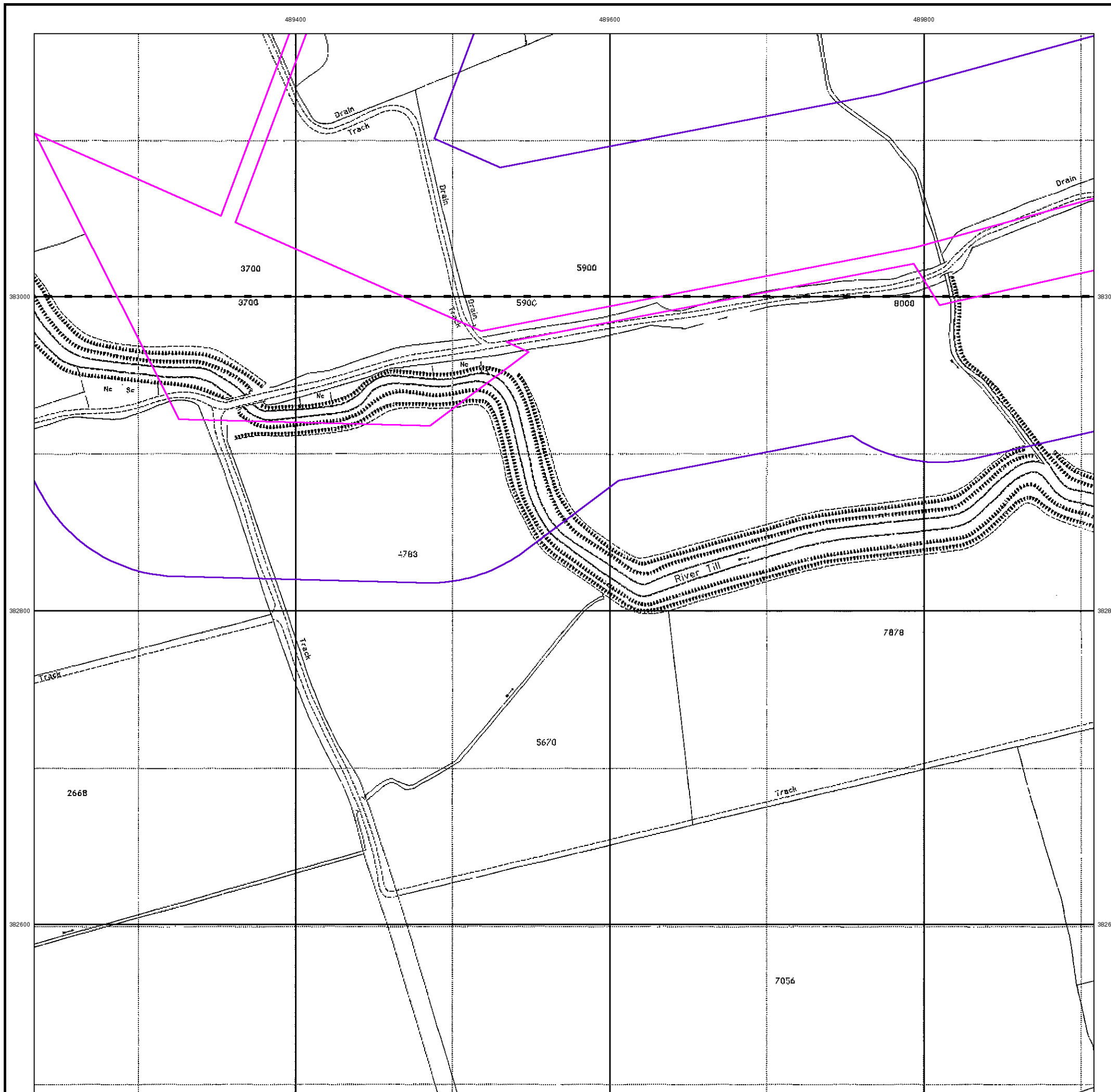

Historical Mapping Legends

Ordnance Survey County Series and Ordnance Survey Plan 1:2,500

Quarry **Gravel Pit** **Sand Pit**
Clay Pit **Shingle** **Refuse Heap**
Sloping Masonry **Flat Rock**
Marsh **Reeds** **Osiers**
Rough Pasture **Furze** **Wood**
Mixed Wood **Brushwood** **Orchard**
Fir **Ford** **Stepping Stones**
Ferry **Waterfall** **Lock**
Trig. Station **Altitude at Trig. Station**
B.M. 325.9 **Bench Mark** **Surface Level**
Arrow denotes flow of water **Antiquities (site of)**
Cutting **Embankment**
Railway crossing Road **Level Crossing** **Road crossing Railway**
Railway crossing River or Canal **Road over single stream** **Road over River or Canal**
County Boundary (Geographical)
County & Civil Parish Boundary
Administrative County & Civil Parish Boundary
County Borough Boundary (England)
Co. Boro. Bdy.
County Burgh Boundary (Scotland)
Co. Burgh Bdy.
BP BS Boundary Post or Stone **P.C.B** Police Call Box
B.R. Bridle Road **P** Pump
E.P Electricity Pylon **S.P** Signal Post
F.B. Foot Bridge **SL** Sluice
F.P. Foot Path **Sp.** Spring
G.P Guide Post or Board **T.C.B** Telephone Call Box
M.S Mile Stone **Tr.** Trough
M.P M.R Mooring Post or Ring **W** Well

Ordnance Survey Plan, Additional SIMs and Supply of Unpublished Survey Information 1:2,500 and 1:1,250

Inactive Quarry, Chalk Pit or Clay Pit **Active Quarry, Chalk Pit or Clay Pit**
Rock **Boulders**
Cliff **Slopes** **Top**
Roofed Building **Glazed Roof Building**
Sloping Masonry **Archway**
Non-Coniferous Tree (surveyed) **Coniferous Tree (surveyed)**
Non-Coniferous Trees (not surveyed) **Coniferous Trees (not surveyed)**
Orchard Tree **Scrub** **Bracken**
Coppice, Osier **Reeds** **Marsh, Saltings**
Rough Grassland **Heath** **Culvert**
Direction of water flow **Bench Mark** **Antiquity (site of)**
Cave Entrance **Triangulation Station** **Electricity Pylon**
Electricity Transmission Line
County Boundary (Geographical)
County & Civil Parish Boundary
Civil Parish Boundary
Admin. County or County Bor. Boundary
London Borough Boundary
Symbol marking point where boundary mereing changes
BH Beer House **P** Pillar, Pole or Post
BP, BS Boundary Post or Stone **PO** Post Office
Cn, C Capstan, Crane **PC** Public Convenience
Chy Chimney **PH** Public House
D Fn Drinking Fountain **Pp** Pump
EI P Electricity Pillar or Post **SB, S Br** Signal Box or Bridge
FAP Fire Alarm Pillar **SP, SL** Signal Post or Light
FB Foot Bridge **Spr** Spring
GP Guide Post **Tk** Tank or Track
H Hydrant or Hydraulic **TCB** Telephone Call Box
LC Level Crossing **TCP** Telephone Call Post
MH Manhole **Tr** Trough
MP Mile Post or Mooring Post **Wr Pt, Wr T** Water Point, Water Tap
MS Mile Stone **W** Well
NTL Normal Tidal Limit **Wd Pp** Wind Pump

Large-Scale National Grid Data 1:2,500 and 1:1,250

Cliff **Slopes** **Top**
Rock **Rock (scattered)**
Boulders **Boulders (scattered)**
Positioned Boulder **Scree**
Non-Coniferous Tree (surveyed) **Coniferous Tree (surveyed)**
Non-Coniferous Trees (not surveyed) **Coniferous Trees (not surveyed)**
Orchard Tree **Scrub** **Bracken**
Coppice, Osier **Reeds** **Marsh, Saltings**
Rough Grassland **Heath** **Culvert**
Direction of water flow **Triangulation Station** **Antiquity (site of)**
Electricity Transmission Line **Electricity Pylon**
B.M. 231.60m Bench Mark **Buildings with Building Seed**
Roofed Building **Glazed Roof Building**
Civil parish/community boundary
District boundary
County boundary
Boundary post/stone
Boundary mereing symbol (note: these always appear in opposed pairs or groups of three)
Bks Barracks **P** Pillar, Pole or Post
Bty Battery **PO** Post Office
Cemy Cemetery **PC** Public Convenience
Chy Chimney **Pp** Pump
Cis Cistern **Ppg Sta** Pumping Station
Dismtd Rly Dismantled Railway **PW** Place of Worship
EI Gen Sta Electricity Generating Station **Sewage Ppg Sta** Sewage Pumping Station
EI P Electricity Pole, Pillar **SB, S Br** Signal Box or Bridge
EI Sub Sta Electricity Sub Station **SP, SL** Signal Post or Light
FB Filter Bed **Spr** Spring
Fn / D Fn Fountain / Drinking Ftn. **Tk** Tank or Track
Gas Gov Gas Valve Compound **Tr** Trough
GVC Gas Governor **Wd Pp** Wind Pump
GP Guide Post **Wr Pt, Wr T** Water Point, Water Tap
MH Manhole **Wks** Works (building or area)
MP, MS Mile Post or Mile Stone **W** Well



Historical Mapping & Photography included:

Mapping Type	Scale	Date	Pg
Lincolnshire	1:2,500	1886	2
Lincolnshire	1:2,500	1906	3
Ordnance Survey Plan	1:2,500	1974 - 1975	4
Large-Scale National Grid Data	1:2,500	1994	5

Historical Map - Segment A11

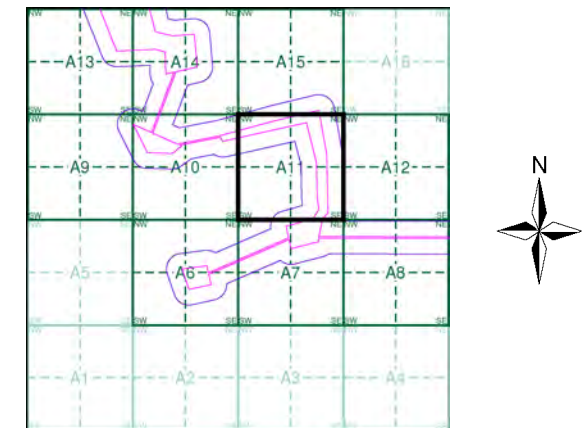

Order Details

Order Number: 297990273_1_1
 Customer Ref: 21-1088.04
 National Grid Reference: 489950, 382840
 Slice: A
 Site Area (Ha): 469.98
 Search Buffer (m): 100

Site Details

Cottam



Tel: [Redacted]
 Fax: [Redacted]
 Web: [Redacted]

Lincolnshire

Published 1886

Source map scale - 1:2,500

The historical maps shown were reproduced from maps predominantly held at the scale adopted for England, Wales and Scotland in the 1840's. In 1854 the 1:2,500 scale was adopted for mapping urban areas and by 1896 it covered the whole of what were considered to be the cultivated parts of Great Britain. The published date given below is often some years later than the surveyed date. Before 1938, all OS maps were based on the Cassini Projection, with independent surveys of a single county or group of counties, giving rise to significant inaccuracies in outlying areas.

Map Name(s) and Date(s)

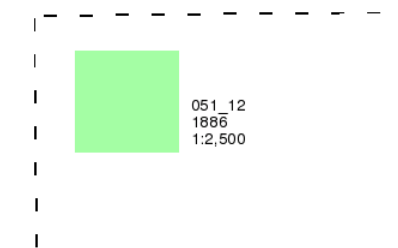

Historical Map - Segment A11

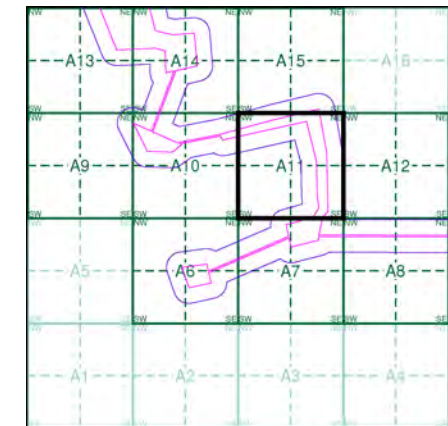

Order Details

Order Number: 297990273_1_1
 Customer Ref: 21-1088.04
 National Grid Reference: 489950, 382840
 Slice: A
 Site Area (Ha): 469.98
 Search Buffer (m): 100

Site Details

Cottam

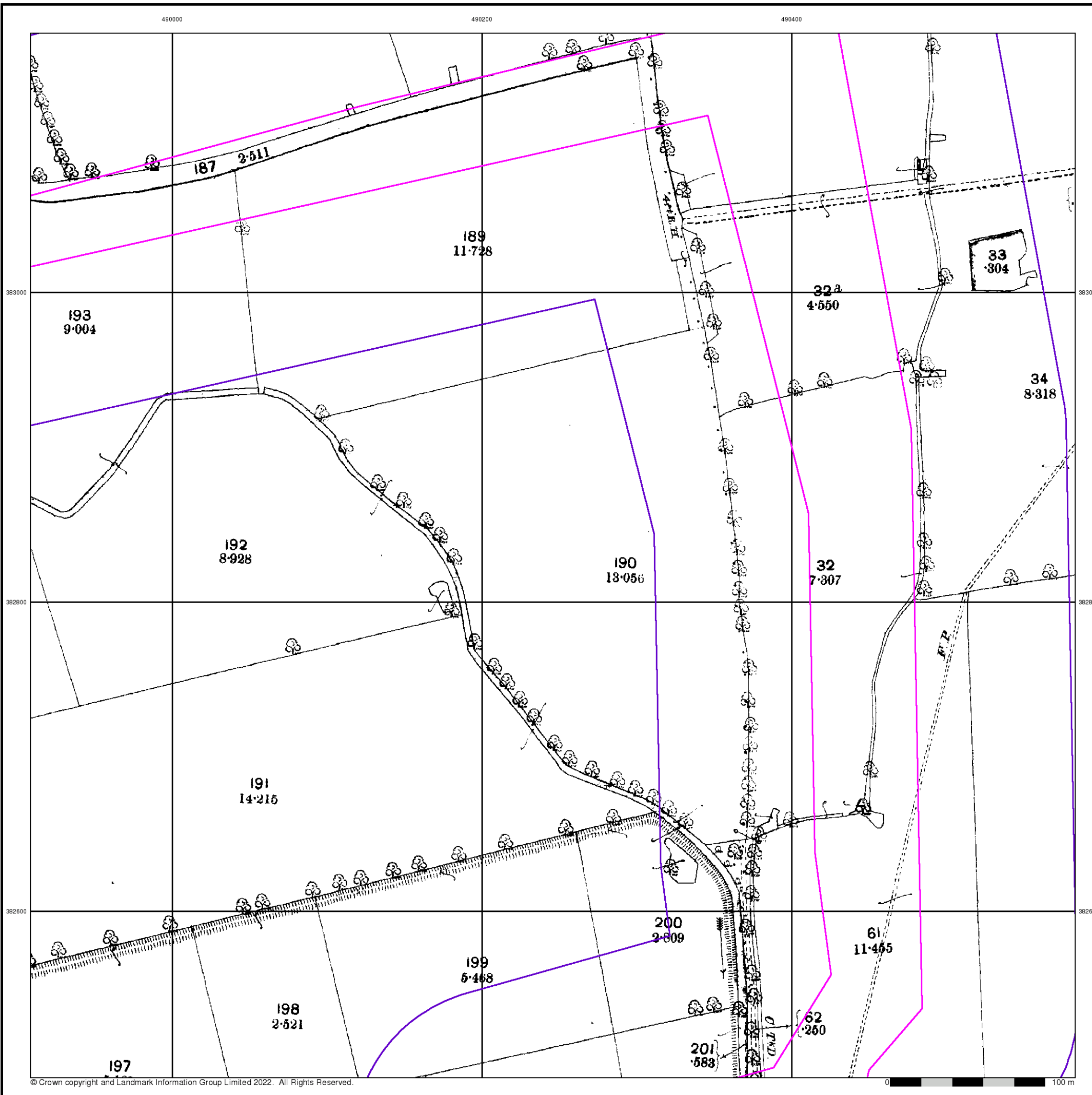

Lincolnshire

Published 1906

Source map scale - 1:2,500

The historical maps shown were reproduced from maps predominantly held at the scale adopted for England, Wales and Scotland in the 1840's. In 1854 the 1:2,500 scale was adopted for mapping urban areas and by 1896 it covered the whole of what were considered to be the cultivated parts of Great Britain. The published date given below is often some years later than the surveyed date. Before 1938, all OS maps were based on the Cassini Projection, with independent surveys of a single county or group of counties, giving rise to significant inaccuracies in outlying areas.

Map Name(s) and Date(s)

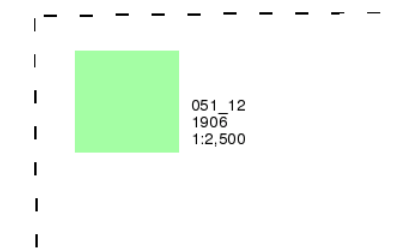

Historical Map - Segment A11

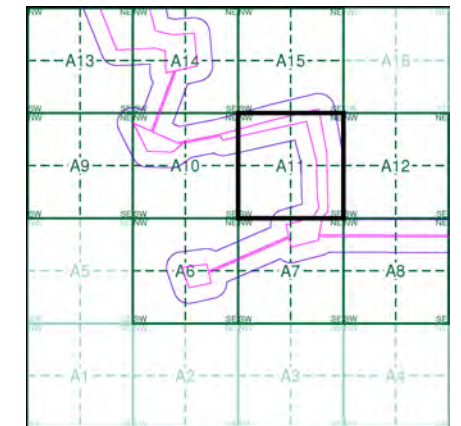

Order Details

Order Number: 297990273_1_1
 Customer Ref: 21-1088.04
 National Grid Reference: 489950, 382840
 Slice: A
 Site Area (Ha): 469.98
 Search Buffer (m): 100

Site Details

Cottam

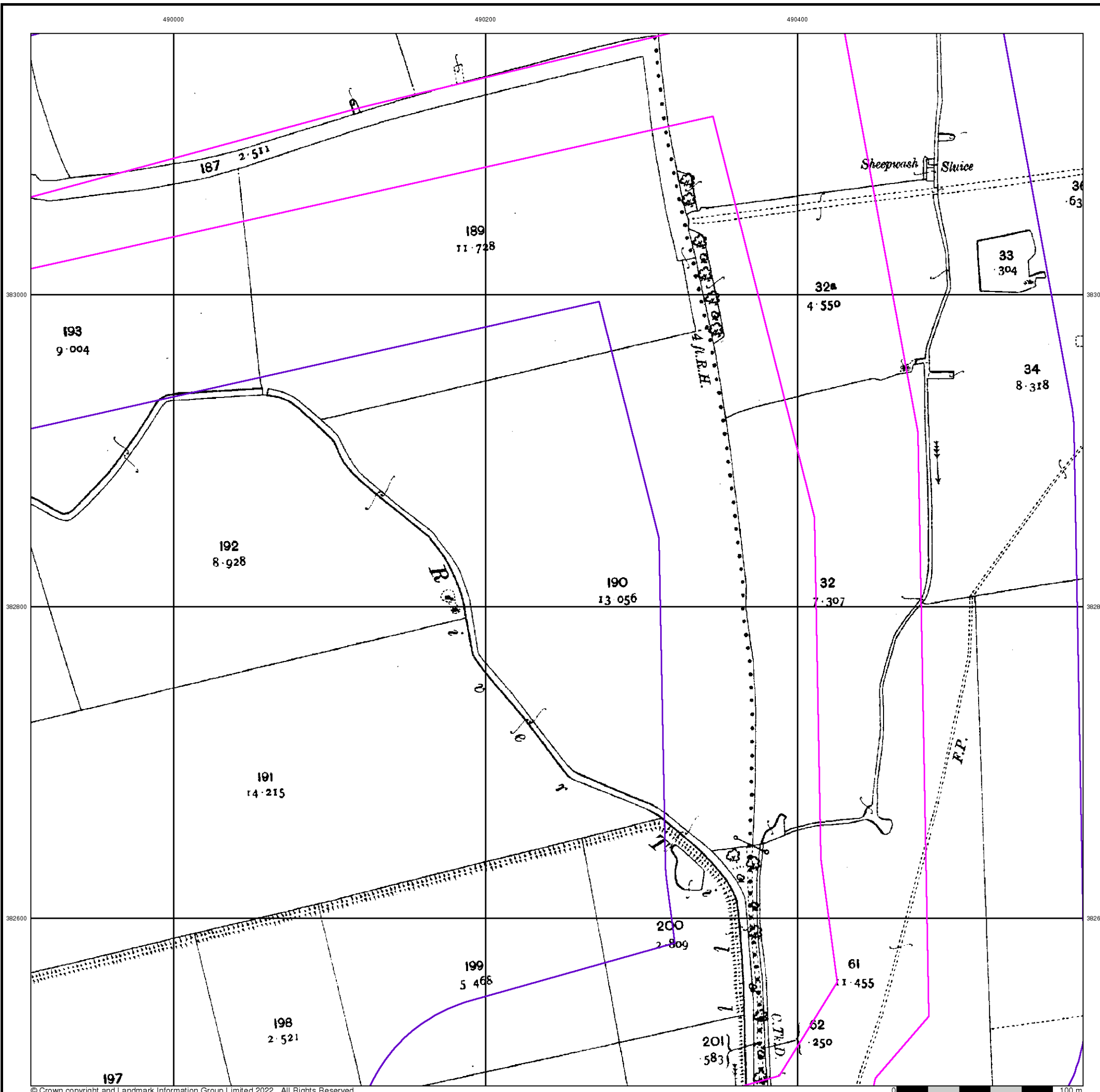

Ordnance Survey Plan
Published 1974 - 1975
Source map scale - 1:2,500

The historical maps shown were reproduced from maps predominantly held at the scale adopted for England, Wales and Scotland in the 1840's. In 1854 the 1:2,500 scale was adopted for mapping urban areas and by 1896 it covered the whole of what were considered to be the cultivated parts of Great Britain. The published date given below is often some years later than the surveyed date. Before 1938, all OS maps were based on the Cassini Projection, with independent surveys of a single county or group of counties, giving rise to significant inaccuracies in outlying areas.

Map Name(s) and Date(s)

SK8983 1975 1:2,500	SK9083 1974 1:2,500
SK8982 1975 1:2,500	SK9082 1974 1:2,500

Historical Map - Segment A11

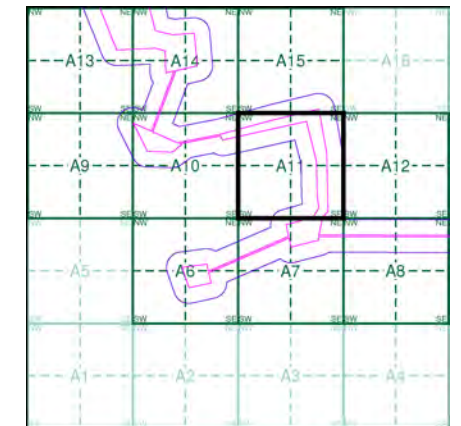

Order Details

Order Number: 297990273_1_1
 Customer Ref: 21-1088.04
 National Grid Reference: 489950, 382840
 Slice: A
 Site Area (Ha): 469.98
 Search Buffer (m): 100

Site Details

Cottam

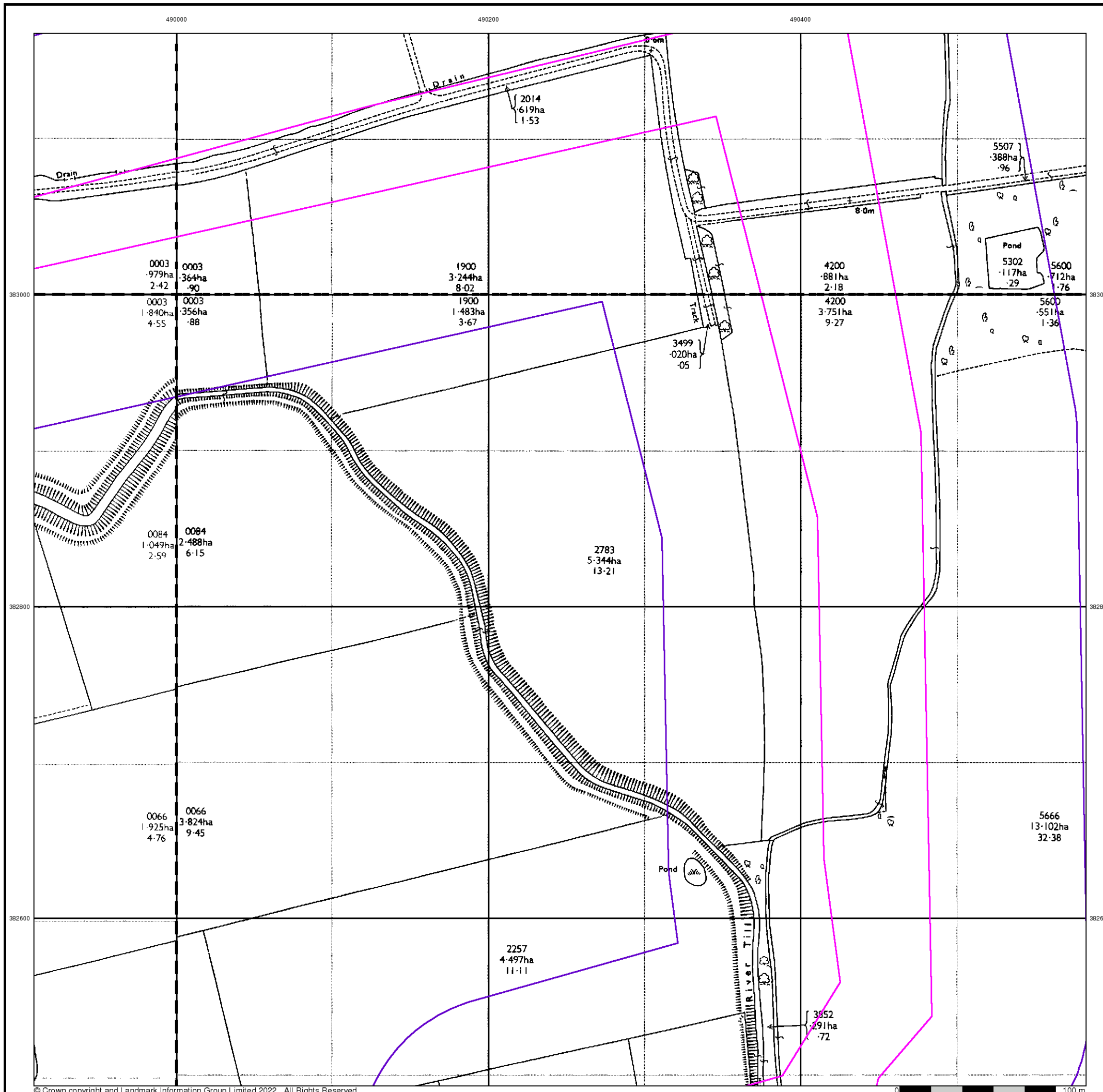

Large-Scale National Grid Data
Published 1994
Source map scale - 1:2,500

'Large Scale National Grid Data' superseded SIM cards (Ordnance Survey's 'Survey of Information on Microfilm') in 1992, and continued to be produced until 1999. These maps were the fore-runners of digital mapping and so provide detailed information on houses and roads, but tend to show less topographic features such as vegetation. These maps were produced at both 1:2,500 and 1:1,250 scales.

Map Name(s) and Date(s)

SK8983 1994 1:2,500	SK9083 1994 1:2,500
SK8982 1994 1:2,500	SK9082 1994 1:2,500

Historical Map - Segment A11

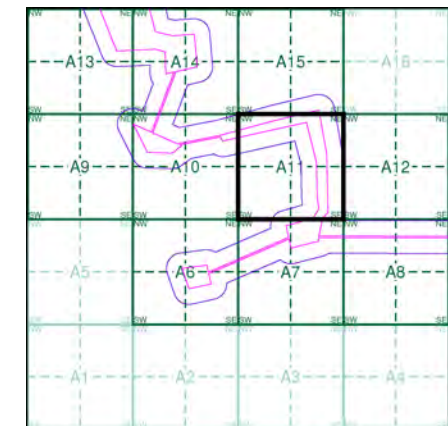

Order Details

Order Number: 297990273_1_1
 Customer Ref: 21-1088.04
 National Grid Reference: 489950, 382840
 Slice: A
 Site Area (Ha): 469.98
 Search Buffer (m): 100

Site Details

Cottam

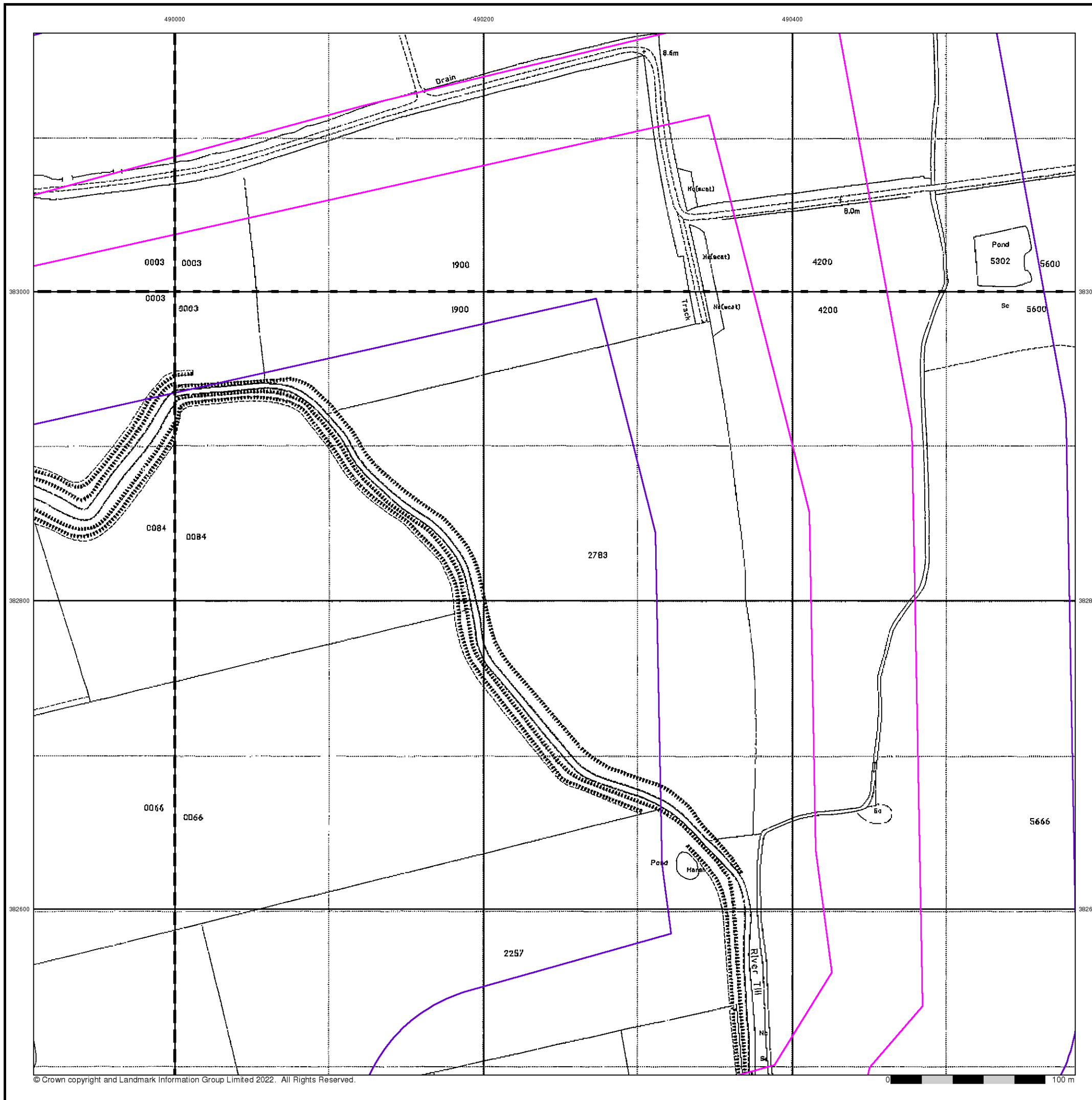

Historical Mapping Legends

Ordnance Survey County Series and Ordnance Survey Plan 1:2,500

Quarry **Gravel Pit** **Sand Pit**
Clay Pit **Shingle** **Refuse Heap**
Sloping Masonry **Flat Rock**
Marsh **Reeds** **Osiers**
Rough Pasture **Furze** **Wood**
Mixed Wood **Brushwood** **Orchard**
Fir **Ford** **Stepping Stones**
Ferry **Waterfall** **Lock**
Trig. Station **Altitude at Trig. Station**
B.M. 325.9 **Bench Mark** **Surface Level**
Arrow denotes flow of water **Antiquities (site of)**
Cutting **Embankment**
Railway crossing Road **Level Crossing** **Road crossing Railway**
Railway crossing River or Canal **Road over single stream** **Road over River or Canal**
County Boundary (Geographical)
County & Civil Parish Boundary
Administrative County & Civil Parish Boundary
County Borough Boundary (England)
County Burgh Boundary (Scotland)
Co. Boro. Bdy.
Co. Burgh Bdy.
BP BS Boundary Post or Stone **P.C.B** Police Call Box
B.R. Bridle Road **P** Pump
E.P Electricity Pylon **S.P** Signal Post
F.B. Foot Bridge **SL** Sluice
F.P. Foot Path **Sp.** Spring
G.P Guide Post or Board **T.C.B** Telephone Call Box
M.S Mile Stone **Tr.** Trough
M.P M.R Mooring Post or Ring **W** Well

Ordnance Survey Plan, Additional SIMs and Supply of Unpublished Survey Information 1:2,500 and 1:1,250

Inactive Quarry, Chalk Pit or Clay Pit **Active Quarry, Chalk Pit or Clay Pit**
Rock **Boulders**
Cliff **Slopes** **Top**
Roofed Building **Glazed Roof Building**
Sloping Masonry **Archway**
Non-Coniferous Tree (surveyed) **Coniferous Tree (surveyed)**
Non-Coniferous Trees (not surveyed) **Coniferous Trees (not surveyed)**
Orchard Tree **Scrub** **Bracken**
Coppice, Osier **Reeds** **Marsh, Saltings**
Rough Grassland **Heath** **Culvert**
Direction of water flow **Bench Mark** **Antiquity (site of)**
Cave Entrance **Triangulation Station** **Electricity Pylon**
Electricity Transmission Line
County Boundary (Geographical)
County & Civil Parish Boundary
Civil Parish Boundary
Admin. County or County Bor. Boundary
London Borough Boundary
Symbol marking point where boundary mereing changes
BH Beer House **P** Pillar, Pole or Post
BP, BS Boundary Post or Stone **PO** Post Office
Cn, C Capstan, Crane **PC** Public Convenience
Chy Chimney **PH** Public House
D Fn Drinking Fountain **Pp** Pump
EI P Electricity Pillar or Post **SB, S Br** Signal Box or Bridge
FAP Fire Alarm Pillar **SP, SL** Signal Post or Light
FB Foot Bridge **Spr** Spring
GP Guide Post **Tk** Tank or Track
H Hydrant or Hydraulic **TCB** Telephone Call Box
LC Level Crossing **TCP** Telephone Call Post
MH Manhole **Tr** Trough
MP Mile Post or Mooring Post **Wr Pt, Wr T** Water Point, Water Tap
MS Mile Stone **W** Well
NTL Normal Tidal Limit **Wd Pp** Wind Pump

Large-Scale National Grid Data 1:2,500 and 1:1,250

Cliff **Slopes** **Top**
Rock **Rock (scattered)**
Boulders **Boulders (scattered)**
Positioned Boulder **Scree**
Non-Coniferous Tree (surveyed) **Coniferous Tree (surveyed)**
Non-Coniferous Trees (not surveyed) **Coniferous Trees (not surveyed)**
Orchard Tree **Scrub** **Bracken**
Coppice, Osier **Reeds** **Marsh, Saltings**
Rough Grassland **Heath** **Culvert**
Direction of water flow **Triangulation Station** **Antiquity (site of)**
Electricity Transmission Line **Electricity Pylon**
B.M. 231.60m Bench Mark **Buildings with Building Seed**
Roofed Building **Glazed Roof Building**
Civil parish/community boundary
District boundary
County boundary
Boundary post/stone
Boundary mereing symbol (note: these always appear in opposed pairs or groups of three)
Bks Barracks **P** Pillar, Pole or Post
Bty Battery **PO** Post Office
Cemy Cemetery **PC** Public Convenience
Chy Chimney **Pp** Pump
Cis Cistern **Ppg Sta** Pumping Station
Dismtd Rly Dismantled Railway **PW** Place of Worship
EI Gen Sta Electricity Generating Station **Sewage Ppg Sta** Sewage Pumping Station
EI P Electricity Pole, Pillar **SB, S Br** Signal Box or Bridge
EI Sub Sta Electricity Sub Station **SP, SL** Signal Post or Light
FB Filter Bed **Spr** Spring
Fn / D Fn Fountain / Drinking Ftn. **Tk** Tank or Track
Gas Gov Gas Valve Compound **Tr** Trough
GVC Gas Governor **Wd Pp** Wind Pump
GP Guide Post **Wr Pt, Wr T** Water Point, Water Tap
MH Manhole **Wks** Works (building or area)
MP, MS Mile Post or Mile Stone **W** Well



Historical Mapping & Photography included:

Mapping Type	Scale	Date	Pg
Lincolnshire	1:2,500	1886	2
Lincolnshire	1:2,500	1906	3
Ordnance Survey Plan	1:2,500	1974	4
Large-Scale National Grid Data	1:2,500	1994	5

Historical Map - Segment A12

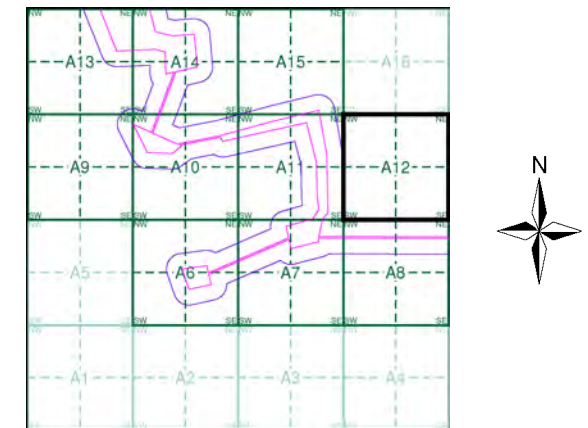

Order Details

Order Number: 297990273_1_1
 Customer Ref: 21-1088.04
 National Grid Reference: 489950, 382840
 Slice: A
 Site Area (Ha): 469.98
 Search Buffer (m): 100

Site Details

Cottam



Tel: [Redacted]
 Fax: [Redacted]
 Web: [Redacted]

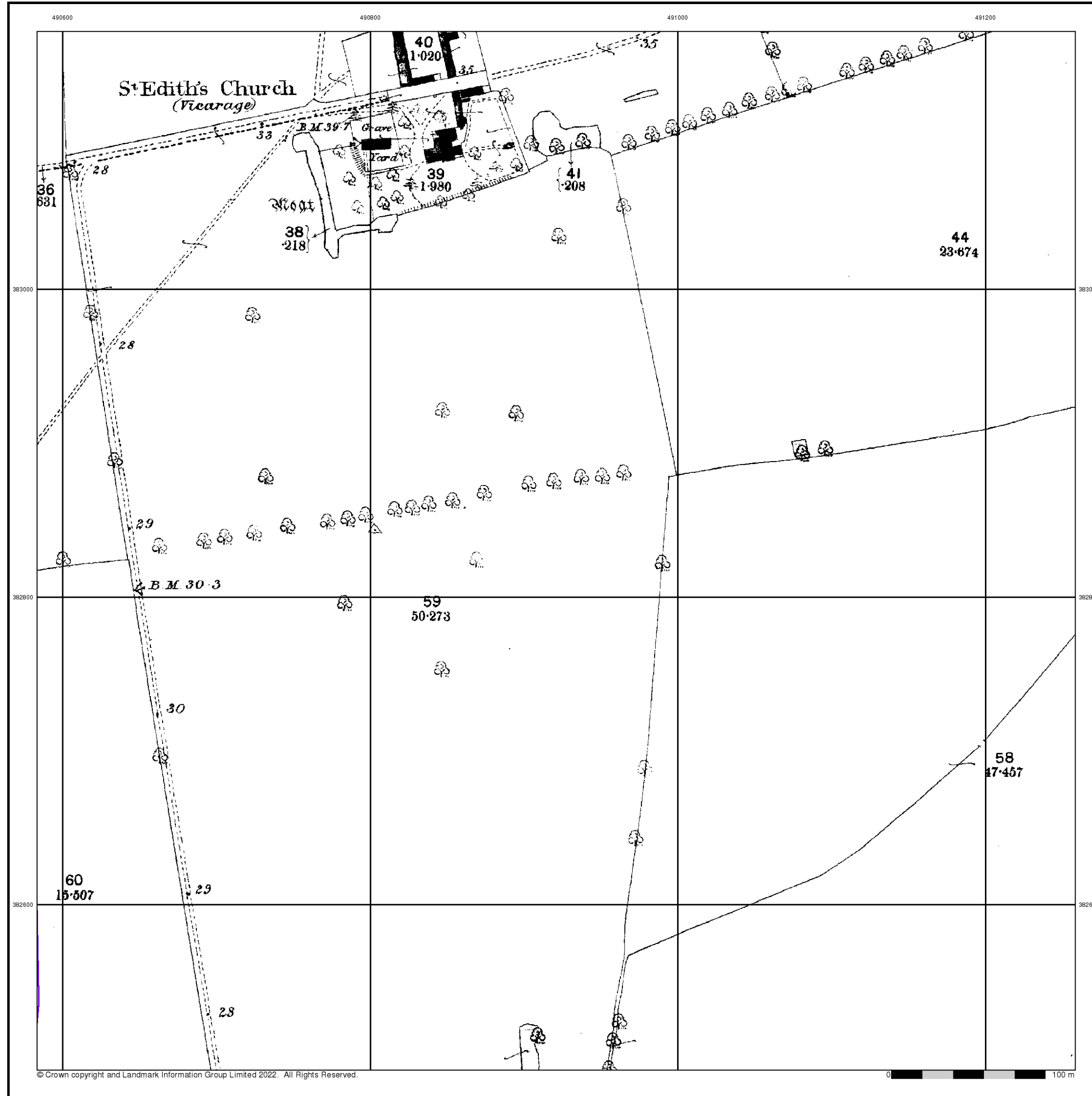

Lincolnshire

Published 1886

Source map scale - 1:2,500

The historical maps shown were reproduced from maps predominantly held at the scale adopted for England, Wales and Scotland in the 1840's. In 1854 the 1:2,500 scale was adopted for mapping urban areas and by 1896 it covered the whole of what were considered to be the cultivated parts of Great Britain. The published date given below is often some years later than the surveyed date. Before 1938, all OS maps were based on the Cassini Projection, with independent surveys of a single county or group of counties, giving rise to significant inaccuracies in outlying areas.

Map Name(s) and Date(s)

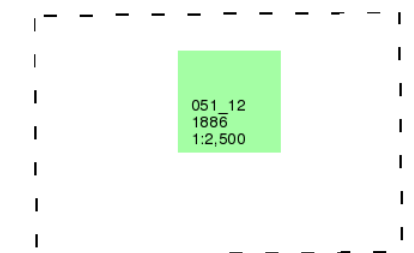

Historical Map - Segment A12

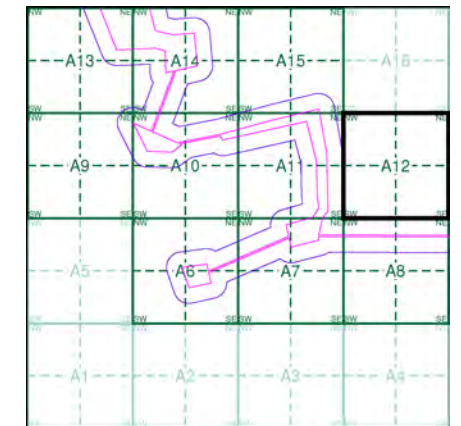

Order Details

Order Number: 297990273_1_1
 Customer Ref: 21-1088.04
 National Grid Reference: 489950, 382840
 Slice: A
 Site Area (Ha): 469.98
 Search Buffer (m): 100

Site Details

Cottam



Tel: [Redacted]
 Fax: [Redacted]
 Web: [Redacted]

Lincolnshire

Published 1906

Source map scale - 1:2,500

The historical maps shown were reproduced from maps predominantly held at the scale adopted for England, Wales and Scotland in the 1840's. In 1854 the 1:2,500 scale was adopted for mapping urban areas and by 1896 it covered the whole of what were considered to be the cultivated parts of Great Britain. The published date given below is often some years later than the surveyed date. Before 1938, all OS maps were based on the Cassini Projection, with independent surveys of a single county or group of counties, giving rise to significant inaccuracies in outlying areas.

Map Name(s) and Date(s)

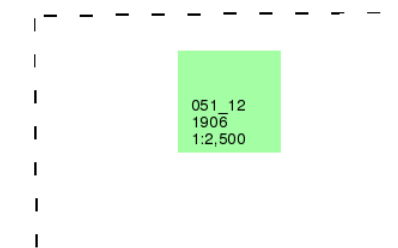

Historical Map - Segment A12

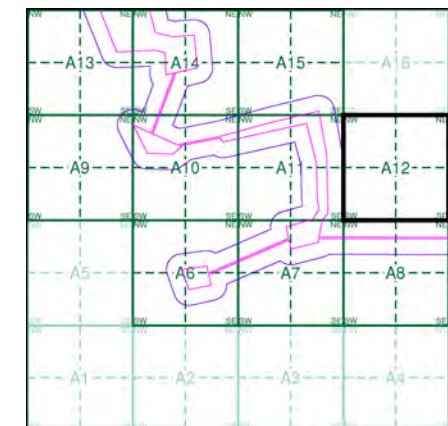

Order Details

Order Number: 297990273_1_1
 Customer Ref: 21-1088.04
 National Grid Reference: 489950, 382840
 Slice: A
 Site Area (Ha): 469.98
 Search Buffer (m): 100

Site Details

Cottam

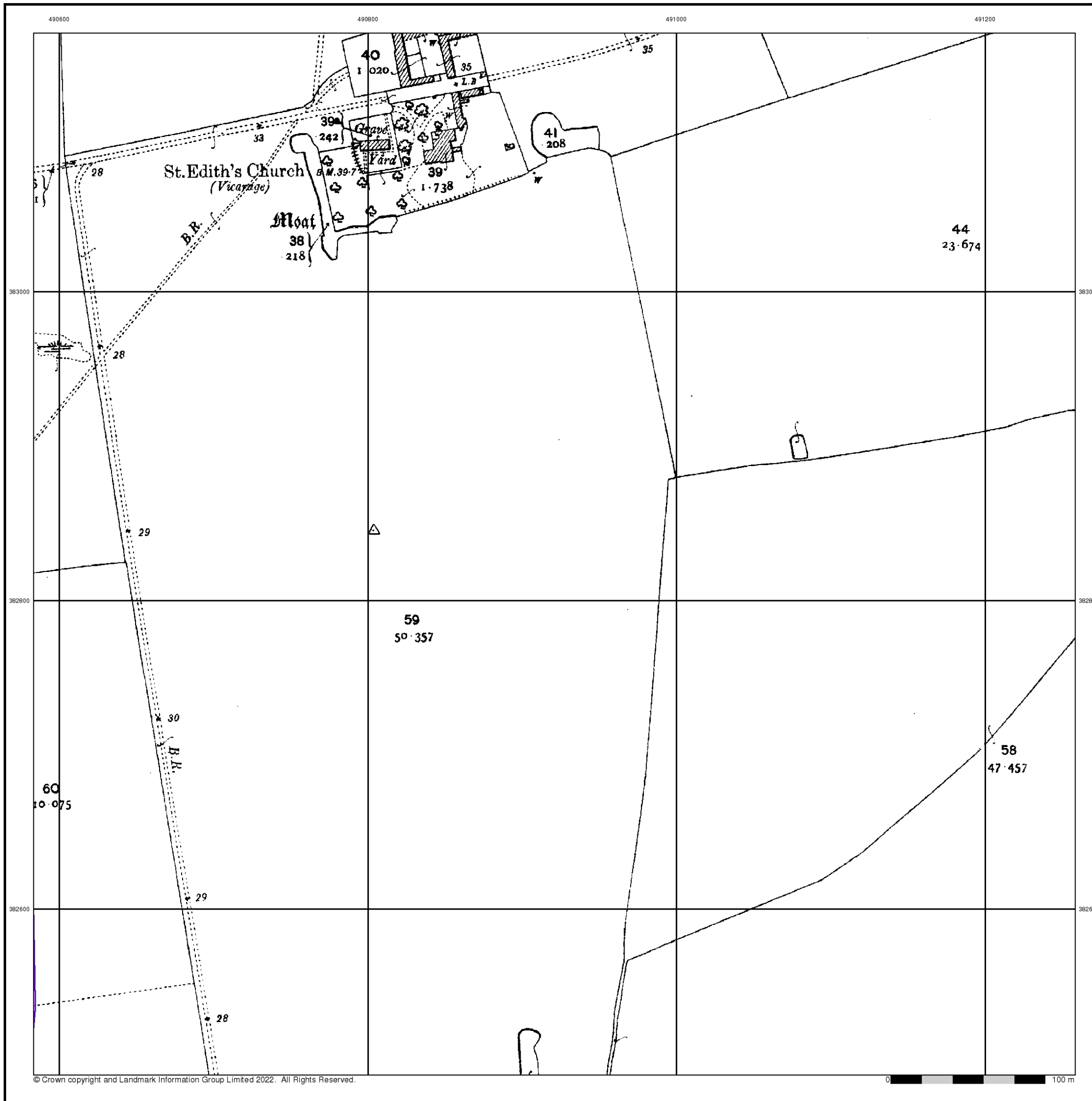

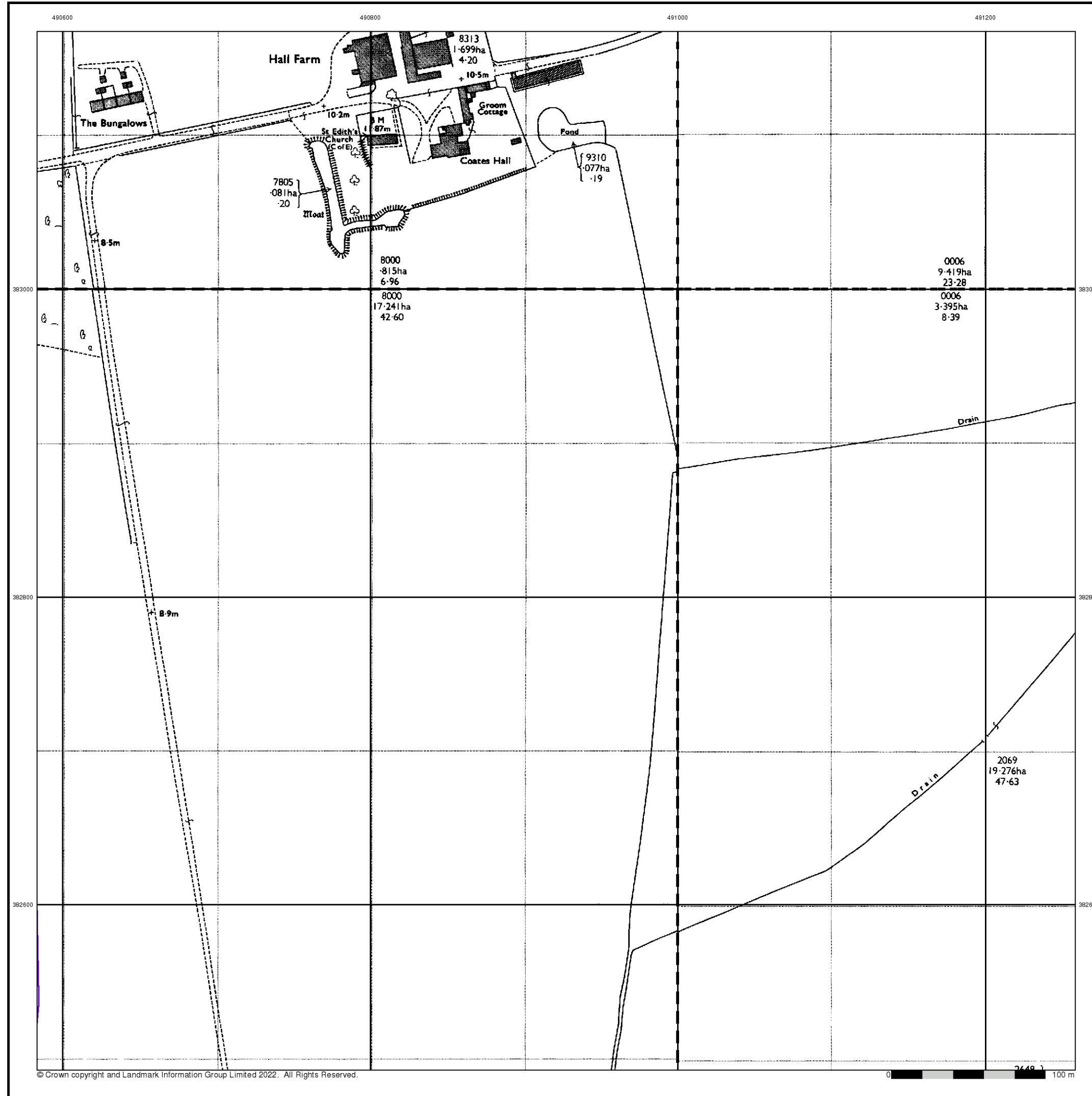

Ordnance Survey Plan

Published 1974

Source map scale - 1:2,500

The historical maps shown were reproduced from maps predominantly held at the scale adopted for England, Wales and Scotland in the 1840's. In 1854 the 1:2,500 scale was adopted for mapping urban areas and by 1896 it covered the whole of what were considered to be the cultivated parts of Great Britain. The published date given below is often some years later than the surveyed date. Before 1938, all OS maps were based on the Cassini Projection, with independent surveys of a single county or group of counties, giving rise to significant inaccuracies in outlying areas.

Map Name(s) and Date(s)

SK9083 1974 1:2,500	SK9183 1974 1:2,500
SK9082 1974 1:2,500	SK9182 1974 1:2,500

Historical Map - Segment A12

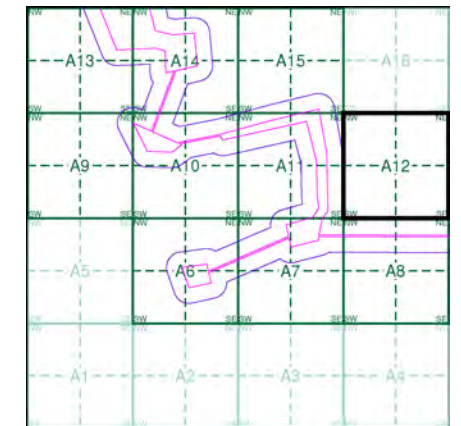

Order Details

Order Number: 297990273_1_1
 Customer Ref: 21-1088.04
 National Grid Reference: 489950, 382840
 Slice: A
 Site Area (Ha): 469.98
 Search Buffer (m): 100

Site Details

Cottam



Tel: [Redacted]
 Fax: [Redacted]
 Web: [Redacted]

Large-Scale National Grid Data

Published 1994

Source map scale - 1:2,500

'Large Scale National Grid Data' superseded SIM cards (Ordnance Survey's 'Survey of Information on Microfilm') in 1992, and continued to be produced until 1999. These maps were the fore-runners of digital mapping and so provide detailed information on houses and roads, but tend to show less topographic features such as vegetation. These maps were produced at both 1:2,500 and 1:1,250 scales.

Map Name(s) and Date(s)

SK9083	SK9183
1994	1994
1:2,500	1:2,500
SK9082	SK9182
1994	1994
1:2,500	1:2,500

Historical Map - Segment A12

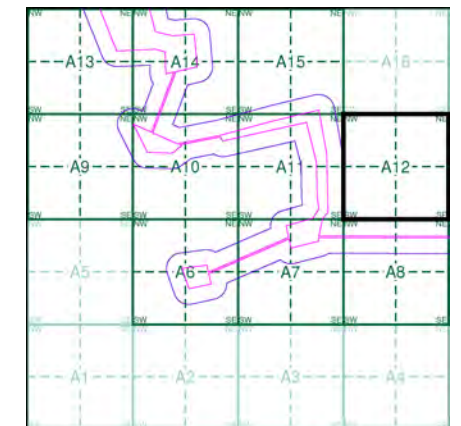

Order Details

Order Number: 297990273_1_1
 Customer Ref: 21-1088.04
 National Grid Reference: 489950, 382840
 Slice: A
 Site Area (Ha): 469.98
 Search Buffer (m): 100

Site Details

Cottam

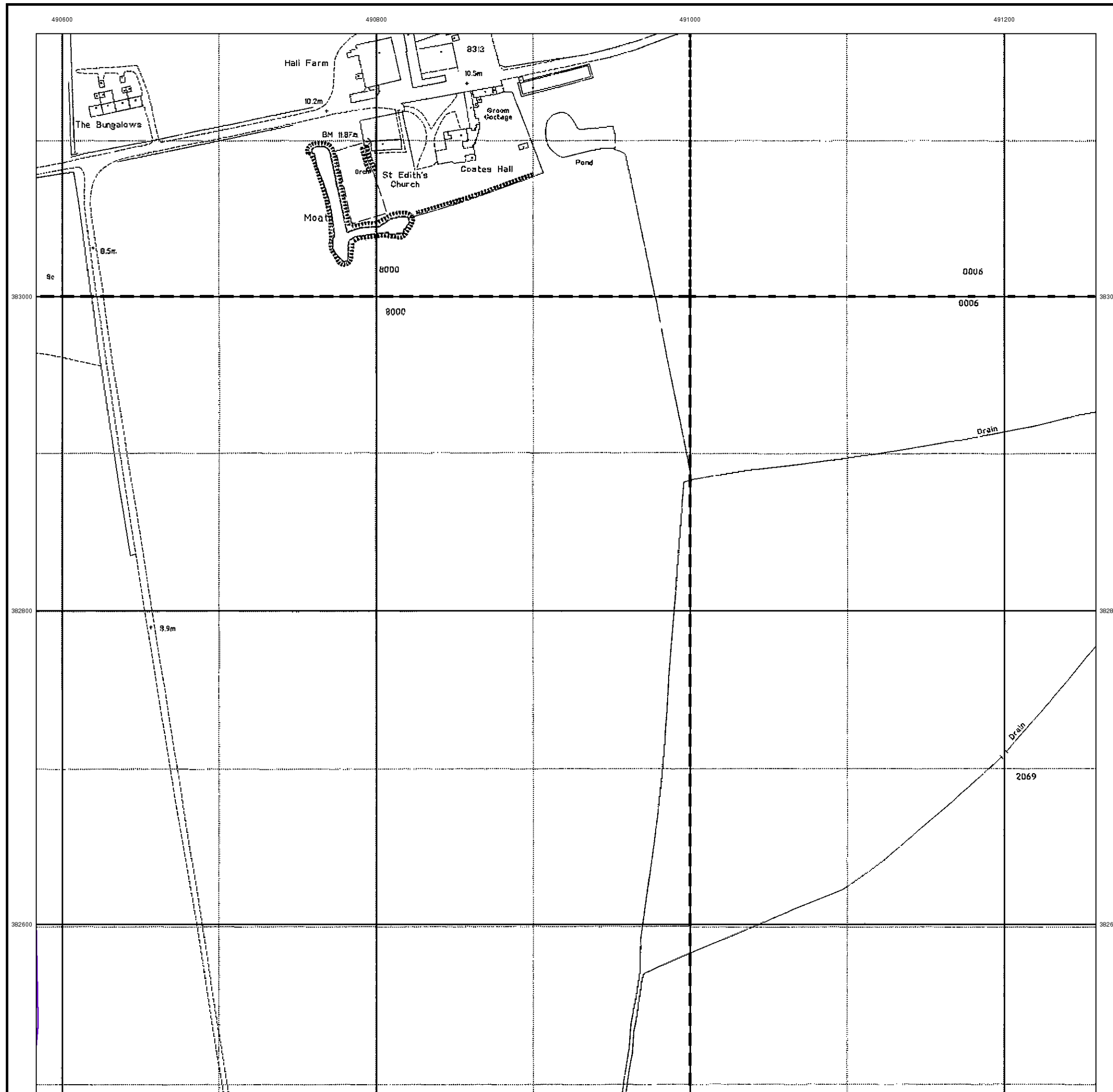

Historical Mapping Legends

Ordnance Survey County Series and Ordnance Survey Plan 1:2,500

Quarry **Gravel Pit** **Sand Pit**
Clay Pit **Shingle** **Refuse Heap**
Sloping Masonry **Flat Rock**
Marsh **Reeds** **Osiers**
Rough Pasture **Furze** **Wood**
Mixed Wood **Brushwood** **Orchard**
Fir **Ford** **Stepping Stones**
Ferry **Waterfall** **Lock**
Trig. Station **Altitude at Trig. Station**
B.M. 325.9 **Bench Mark** **Surface Level**
Arrow denotes flow of water **Antiquities (site of)**
Cutting **Embankment**
Railway crossing Road **Level Crossing** **Road crossing Railway**
Railway crossing River or Canal **Road over single stream** **Road over River or Canal**
County Boundary (Geographical)
County & Civil Parish Boundary
Administrative County & Civil Parish Boundary
County Borough Boundary (England)
County Burgh Boundary (Scotland)
Co. Boro. Bdy.
Co. Burgh Bdy.
BP BS Boundary Post or Stone **P.C.B** Police Call Box
B.R. Bridle Road **P** Pump
E.P Electricity Pylon **S.P** Signal Post
F.B. Foot Bridge **SL** Sluice
F.P. Foot Path **Sp.** Spring
G.P Guide Post or Board **T.C.B** Telephone Call Box
M.S Mile Stone **Tr.** Trough
M.P M.R Mooring Post or Ring **W** Well

Ordnance Survey Plan, Additional SIMs and Supply of Unpublished Survey Information 1:2,500 and 1:1,250

Inactive Quarry, Chalk Pit or Clay Pit **Active Quarry, Chalk Pit or Clay Pit**
Rock **Boulders**
Cliff **Slopes** **Top**
Roofed Building **Glazed Roof Building**
Sloping Masonry **Archway**
Non-Coniferous Tree (surveyed) **Coniferous Tree (surveyed)**
Non-Coniferous Trees (not surveyed) **Coniferous Trees (not surveyed)**
Orchard Tree **Scrub** **Bracken**
Coppice, Osier **Reeds** **Marsh, Saltings**
Rough Grassland **Heath** **Culvert**
Direction of water flow **Bench Mark** **Antiquity (site of)**
Cave Entrance **Triangulation Station** **Electricity Pylon**
Electricity Transmission Line
County Boundary (Geographical)
County & Civil Parish Boundary
Civil Parish Boundary
Admin. County or County Bor. Boundary
London Borough Boundary
Symbol marking point where boundary mereing changes
BH Beer House **P** Pillar, Pole or Post
BP, BS Boundary Post or Stone **PO** Post Office
Cn, C Capstan, Crane **PC** Public Convenience
Chy Chimney **PH** Public House
D Fn Drinking Fountain **Pp** Pump
EI P Electricity Pillar or Post **SB, S Br** Signal Box or Bridge
FAP Fire Alarm Pillar **SP, SL** Signal Post or Light
FB Foot Bridge **Spr** Spring
GP Guide Post **Tk** Tank or Track
H Hydrant or Hydraulic **TCB** Telephone Call Box
LC Level Crossing **TCP** Telephone Call Post
MH Manhole **Tr** Trough
MP Mile Post or Mooring Post **Wr Pt, Wr T** Water Point, Water Tap
MS Mile Stone **W** Well
NTL Normal Tidal Limit **Wd Pp** Wind Pump

Large-Scale National Grid Data 1:2,500 and 1:1,250

Cliff **Slopes** **Top**
Rock **Rock (scattered)**
Boulders **Boulders (scattered)**
Positioned Boulder **Scree**
Non-Coniferous Tree (surveyed) **Coniferous Tree (surveyed)**
Non-Coniferous Trees (not surveyed) **Coniferous Trees (not surveyed)**
Orchard Tree **Scrub** **Bracken**
Coppice, Osier **Reeds** **Marsh, Saltings**
Rough Grassland **Heath** **Culvert**
Direction of water flow **Triangulation Station** **Antiquity (site of)**
Electricity Transmission Line **Electricity Pylon**
B.M. 231.60m Bench Mark **Buildings with Building Seed**
Roofed Building **Glazed Roof Building**
Civil parish/community boundary
District boundary
County boundary
Boundary post/stone
Boundary mereing symbol (note: these always appear in opposed pairs or groups of three)
Bks Barracks **P** Pillar, Pole or Post
Bty Battery **PO** Post Office
Cemy Cemetery **PC** Public Convenience
Chy Chimney **Pp** Pump
Cis Cistern **Ppg Sta** Pumping Station
Dismtd Rly Dismantled Railway **PW** Place of Worship
EI Gen Sta Electricity Generating Station **Sewage Ppg Sta** Sewage Pumping Station
EI P Electricity Pole, Pillar **SB, S Br** Signal Box or Bridge
EI Sub Sta Electricity Sub Station **SP, SL** Signal Post or Light
FB Filter Bed **Spr** Spring
Fn / D Fn Fountain / Drinking Ftn. **Tk** Tank or Track
Gas Gov Gas Valve Compound **Tr** Trough
GVC Gas Governor **Wd Pp** Wind Pump
GP Guide Post **Wr Pt, Wr T** Water Point, Water Tap
MH Manhole **Wks** Works (building or area)
MP, MS Mile Post or Mile Stone **W** Well



Historical Mapping & Photography included:

Mapping Type	Scale	Date	Pg
Lincolnshire	1:2,500	1886	2
Lincolnshire	1:2,500	1906	3
Ordnance Survey Plan	1:2,500	1975	4
Large-Scale National Grid Data	1:2,500	1994	5

Historical Map - Segment A13

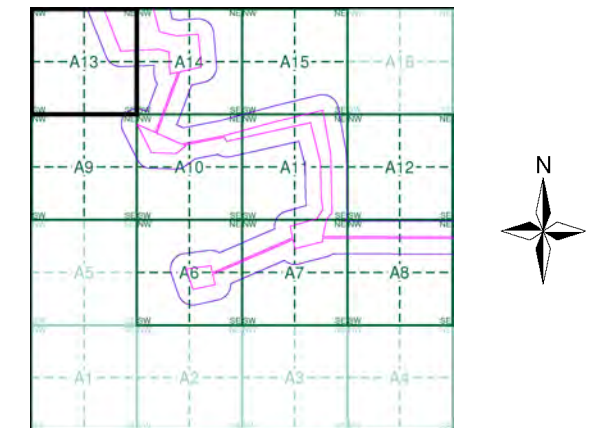

Order Details

Order Number: 297990273_1_1
 Customer Ref: 21-1088.04
 National Grid Reference: 489950, 382840
 Slice: A
 Site Area (Ha): 469.98
 Search Buffer (m): 100

Site Details

Cottam



Tel:
Fax:
Web:

Lincolnshire

Published 1886

Source map scale - 1:2,500

The historical maps shown were reproduced from maps predominantly held at the scale adopted for England, Wales and Scotland in the 1840's. In 1854 the 1:2,500 scale was adopted for mapping urban areas and by 1896 it covered the whole of what were considered to be the cultivated parts of Great Britain. The published date given below is often some years later than the surveyed date. Before 1938, all OS maps were based on the Cassini Projection, with independent surveys of a single county or group of counties, giving rise to significant inaccuracies in outlying areas.

Map Name(s) and Date(s)

051_07	1886	1:2,500
051_11	1886	1:2,500

Historical Map - Segment A13

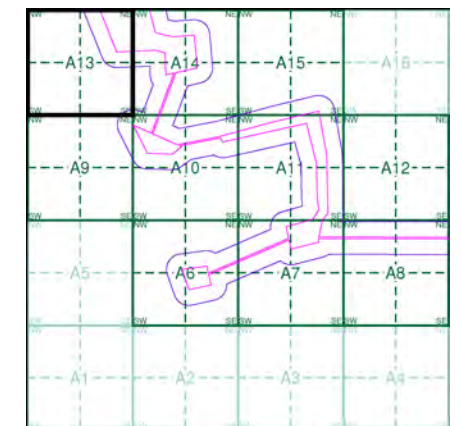

Order Details

Order Number: 297990273_1_1
 Customer Ref: 21-1088.04
 National Grid Reference: 489950, 382840
 Slice: A
 Site Area (Ha): 469.98
 Search Buffer (m): 100

Site Details

Cottam

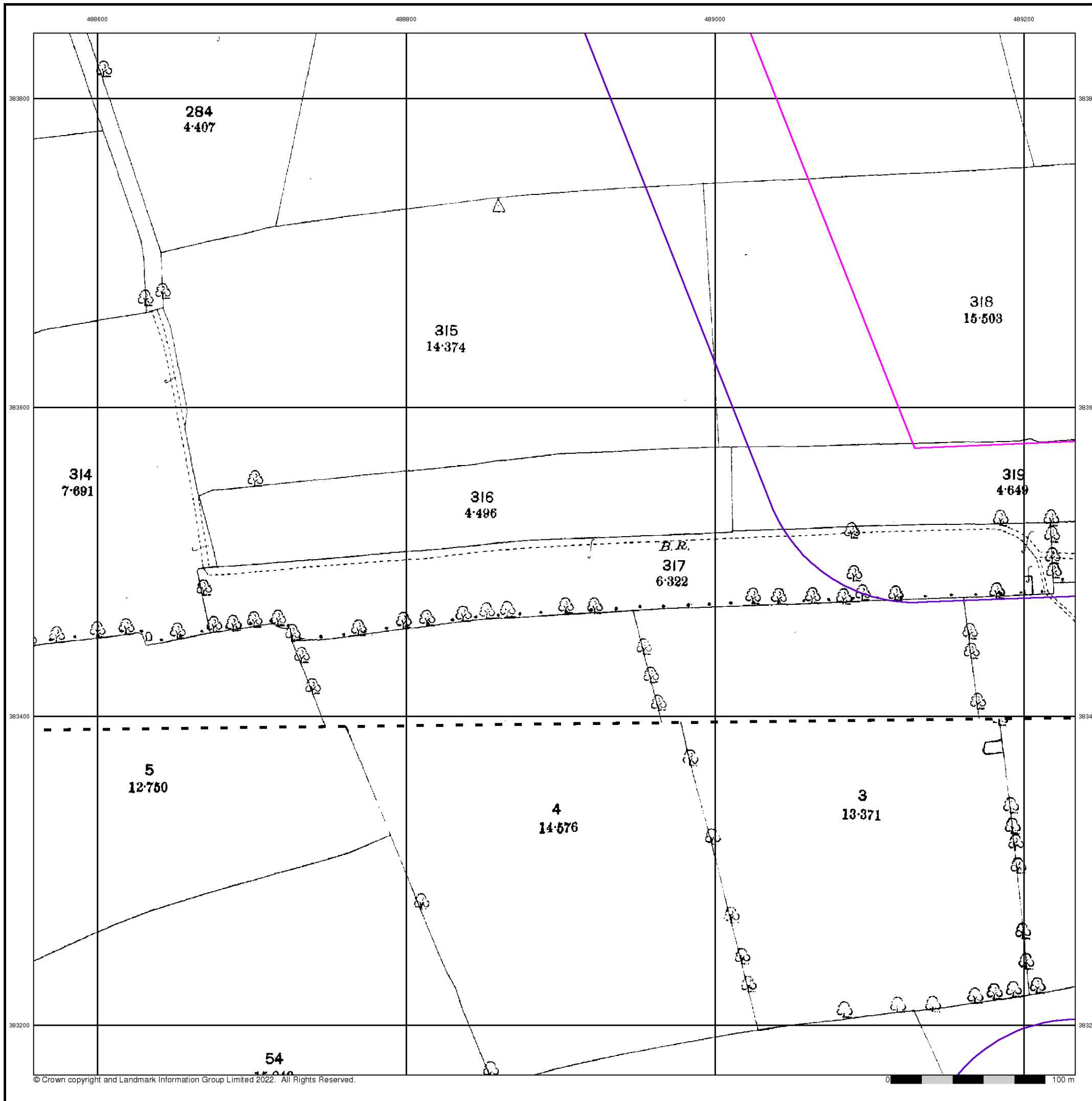

Lincolnshire
Published 1906

Source map scale - 1:2,500

The historical maps shown were reproduced from maps predominantly held at the scale adopted for England, Wales and Scotland in the 1840's. In 1854 the 1:2,500 scale was adopted for mapping urban areas and by 1896 it covered the whole of what were considered to be the cultivated parts of Great Britain. The published date given below is often some years later than the surveyed date. Before 1938, all OS maps were based on the Cassini Projection, with independent surveys of a single county or group of counties, giving rise to significant inaccuracies in outlying areas.

Map Name(s) and Date(s)

051_07	1906	1:2,500
051_11	1906	1:2,500

Historical Map - Segment A13

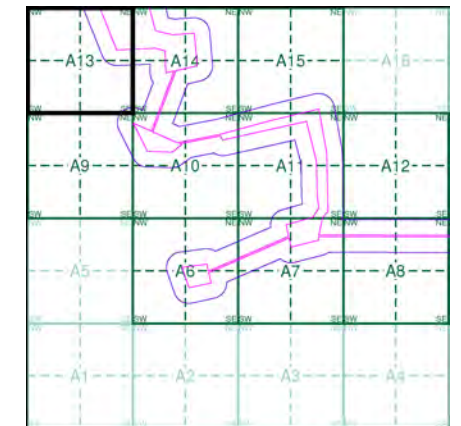

Order Details

Order Number: 297990273_1_1
 Customer Ref: 21-1088.04
 National Grid Reference: 489950, 382840
 Slice: A
 Site Area (Ha): 469.98
 Search Buffer (m): 100

Site Details

Cottam

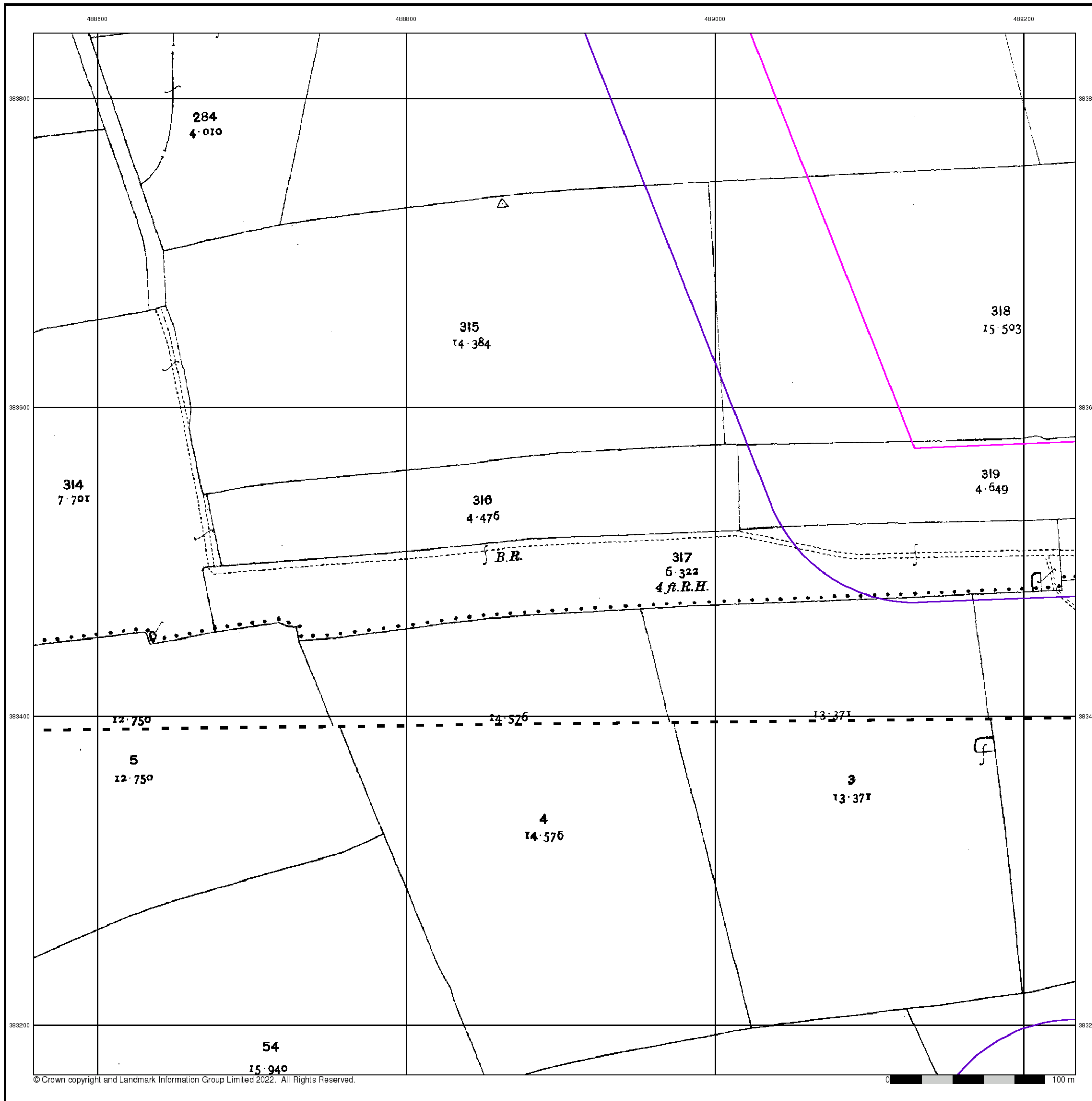

Ordnance Survey Plan

Published 1975

Source map scale - 1:2,500

The historical maps shown were reproduced from maps predominantly held at the scale adopted for England, Wales and Scotland in the 1840's. In 1854 the 1:2,500 scale was adopted for mapping urban areas and by 1896 it covered the whole of what were considered to be the cultivated parts of Great Britain. The published date given below is often some years later than the surveyed date. Before 1938, all OS maps were based on the Cassini Projection, with independent surveys of a single county or group of counties, giving rise to significant inaccuracies in outlying areas.

Map Name(s) and Date(s)

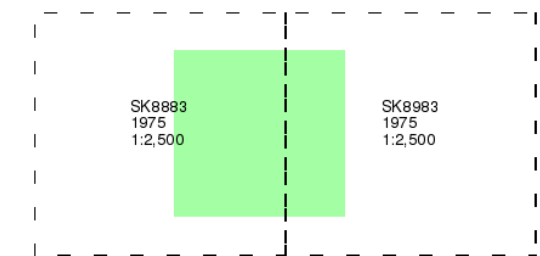

Historical Map - Segment A13

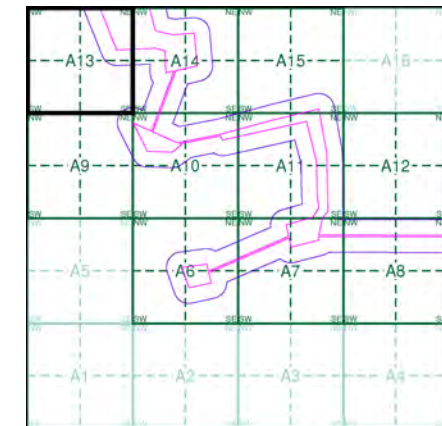

Order Details

Order Number: 297990273_1_1
 Customer Ref: 21-1088.04
 National Grid Reference: 489950, 382840
 Slice: A
 Site Area (Ha): 469.98
 Search Buffer (m): 100

Site Details

Cottam

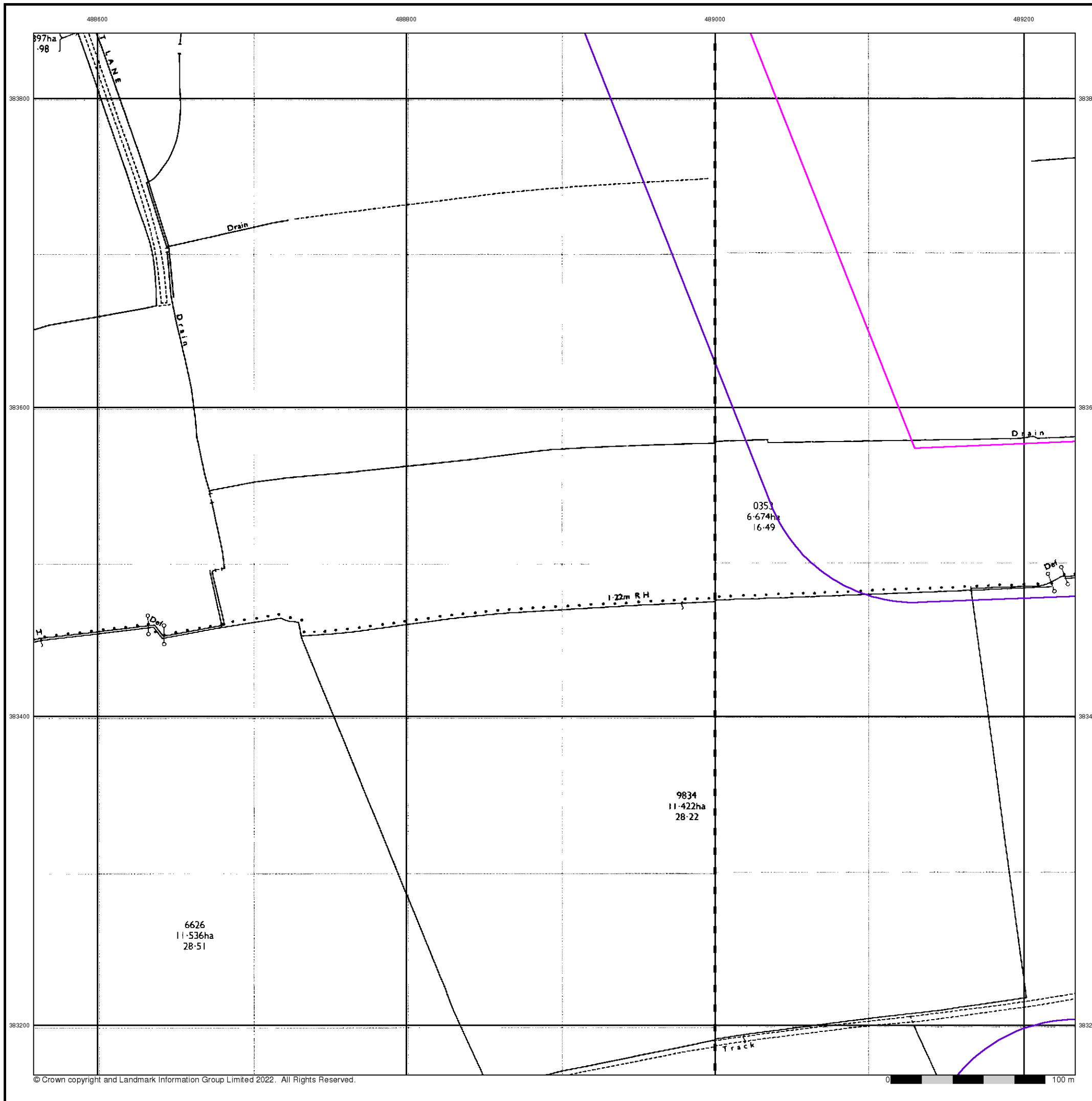

Large-Scale National Grid Data

Published 1994

Source map scale - 1:2,500

'Large Scale National Grid Data' superseded SIM cards (Ordnance Survey's 'Survey of Information on Microfilm') in 1992, and continued to be produced until 1999. These maps were the fore-runners of digital mapping and so provide detailed information on houses and roads, but tend to show less topographic features such as vegetation. These maps were produced at both 1:2,500 and 1:1,250 scales.

Map Name(s) and Date(s)

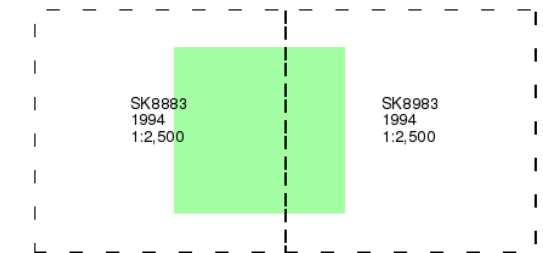

Historical Map - Segment A13

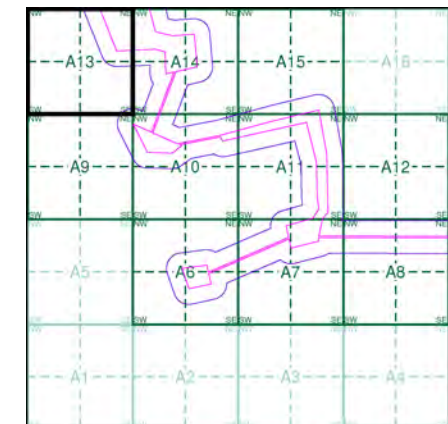

Order Details

Order Number: 297990273_1_1
 Customer Ref: 21-1088.04
 National Grid Reference: 489950, 382840
 Slice: A
 Site Area (Ha): 469.98
 Search Buffer (m): 100

Site Details

Cottam

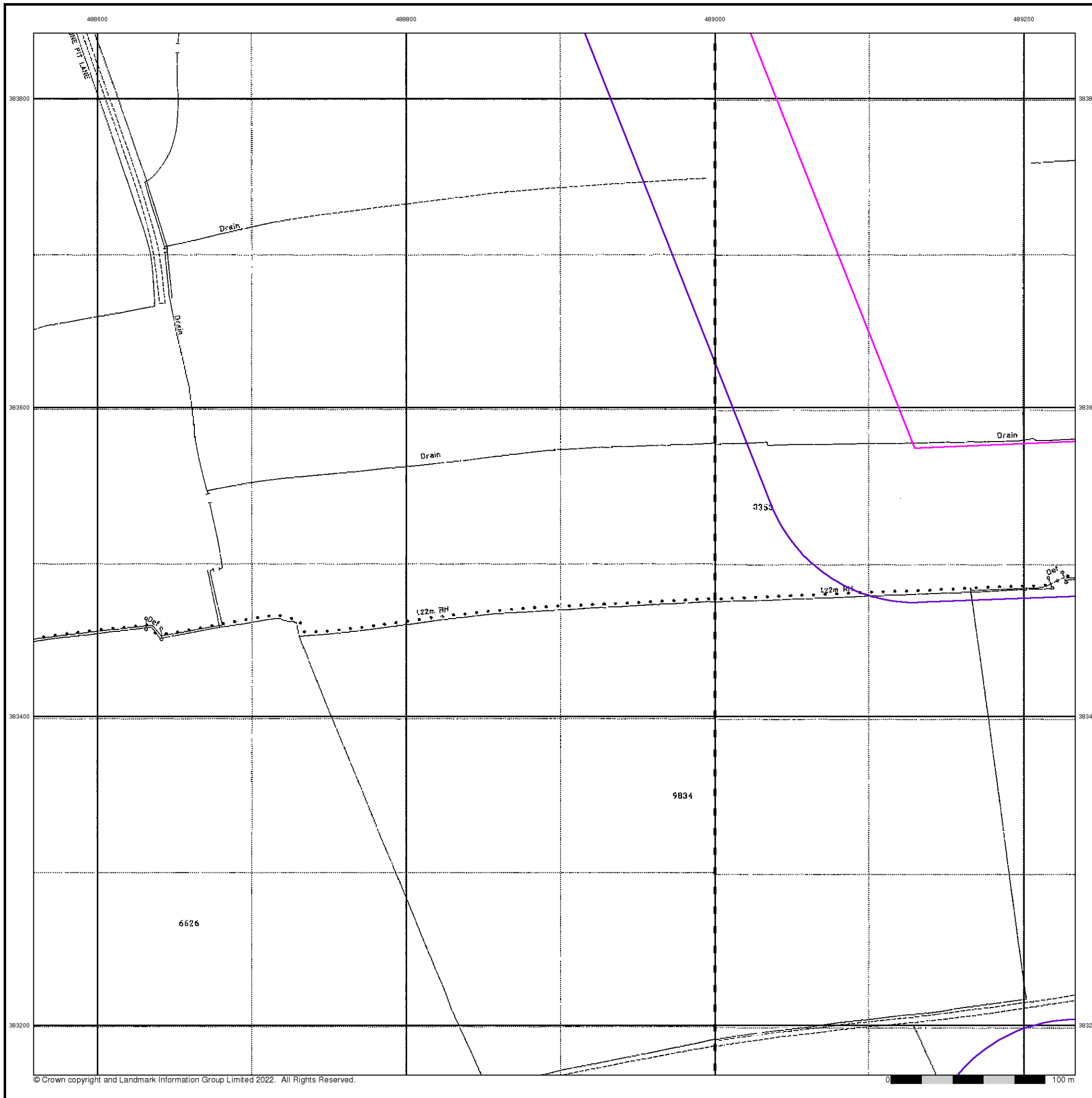

Historical Mapping Legends

Ordnance Survey County Series and Ordnance Survey Plan 1:2,500

Quarry **Gravel Pit** **Sand Pit**
Clay Pit **Shingle** **Refuse Heap**
Sloping Masonry **Flat Rock**
Marsh **Reeds** **Osiers**
Rough Pasture **Furze** **Wood**
Mixed Wood **Brushwood** **Orchard**
Fir **Ford** **Stepping Stones**
Ferry **Waterfall** **Lock**
Trig. Station **Altitude at Trig. Station**
B.M. 325.9 **Bench Mark** **Surface Level**
Arrow denotes flow of water **Antiquities (site of)**
Cutting **Embankment**
Railway crossing Road **Level Crossing** **Road crossing Railway**
Railway crossing River or Canal **Road over single stream** **Road over River or Canal**
County Boundary (Geographical)
County & Civil Parish Boundary
Administrative County & Civil Parish Boundary
County Borough Boundary (England)
County Burgh Boundary (Scotland)
Co. Boro. Bdy.
Co. Burgh Bdy.
BP BS Boundary Post or Stone **P.C.B** Police Call Box
B.R. Bridle Road **P** Pump
E.P Electricity Pylon **S.P** Signal Post
F.B. Foot Bridge **SL** Sluice
F.P. Foot Path **Sp.** Spring
G.P Guide Post or Board **T.C.B** Telephone Call Box
M.S Mile Stone **Tr.** Trough
M.P M.R Mooring Post or Ring **W** Well

Ordnance Survey Plan, Additional SIMs and Supply of Unpublished Survey Information 1:2,500 and 1:1,250

Inactive Quarry, Chalk Pit or Clay Pit **Active Quarry, Chalk Pit or Clay Pit**
Rock **Boulders**
Cliff **Slopes** **Top**
Roofed Building **Glazed Roof Building**
Sloping Masonry **Archway**
Non-Coniferous Tree (surveyed) **Coniferous Tree (surveyed)**
Non-Coniferous Trees (not surveyed) **Coniferous Trees (not surveyed)**
Orchard Tree **Scrub** **Bracken**
Coppice, Osier **Reeds** **Marsh, Saltings**
Rough Grassland **Heath** **Culvert**
Direction of water flow **Bench Mark** **Antiquity (site of)**
Cave Entrance **Triangulation Station** **Electricity Pylon**
Electricity Transmission Line
County Boundary (Geographical)
County & Civil Parish Boundary
Civil Parish Boundary
Admin. County or County Bor. Boundary
London Borough Boundary
Symbol marking point where boundary mereing changes
BH Beer House **P** Pillar, Pole or Post
BP, BS Boundary Post or Stone **PO** Post Office
Cn, C Capstan, Crane **PC** Public Convenience
Chy Chimney **PH** Public House
D Fn Drinking Fountain **Pp** Pump
EI P Electricity Pillar or Post **SB, S Br** Signal Box or Bridge
FAP Fire Alarm Pillar **SP, SL** Signal Post or Light
FB Foot Bridge **Spr** Spring
GP Guide Post **Tk** Tank or Track
H Hydrant or Hydraulic **TCB** Telephone Call Box
LC Level Crossing **TCP** Telephone Call Post
MH Manhole **Tr** Trough
MP Mile Post or Mooring Post **Wr Pt, Wr T** Water Point, Water Tap
MS Mile Stone **W** Well
NTL Normal Tidal Limit **Wd Pp** Wind Pump

Large-Scale National Grid Data 1:2,500 and 1:1,250

Cliff **Slopes** **Top**
Rock **Rock (scattered)**
Boulders **Boulders (scattered)**
Positioned Boulder **Scree**
Non-Coniferous Tree (surveyed) **Coniferous Tree (surveyed)**
Non-Coniferous Trees (not surveyed) **Coniferous Trees (not surveyed)**
Orchard Tree **Scrub** **Bracken**
Coppice, Osier **Reeds** **Marsh, Saltings**
Rough Grassland **Heath** **Culvert**
Direction of water flow **Triangulation Station** **Antiquity (site of)**
Electricity Transmission Line **Electricity Pylon**
B.M. 231.60m Bench Mark **Buildings with Building Seed**
Roofed Building **Glazed Roof Building**
Civil parish/community boundary
District boundary
County boundary
Boundary post/stone
Boundary mereing symbol (note: these always appear in opposed pairs or groups of three)
Bks Barracks **P** Pillar, Pole or Post
Bty Battery **PO** Post Office
Cemy Cemetery **PC** Public Convenience
Chy Chimney **Pp** Pump
Cis Cistern **Ppg Sta** Pumping Station
Dismtd Rly Dismantled Railway **PW** Place of Worship
EI Gen Sta Electricity Generating Station **Sewage Ppg Sta** Sewage Pumping Station
EI P Electricity Pole, Pillar **SB, S Br** Signal Box or Bridge
EI Sub Sta Electricity Sub Station **SP, SL** Signal Post or Light
FB Filter Bed **Spr** Spring
Fn / D Fn Fountain / Drinking Ftn. **Tk** Tank or Track
Gas Gov Gas Valve Compound **Tr** Trough
GVC Gas Governor **Wd Pp** Wind Pump
GP Guide Post **Wr Pt, Wr T** Water Point, Water Tap
MH Manhole **Wks** Works (building or area)
MP, MS Mile Post or Mile Stone **W** Well



Historical Mapping & Photography included:

Mapping Type	Scale	Date	Pg
Lincolnshire	1:2,500	1886	2
Lincolnshire	1:2,500	1906	3
Ordnance Survey Plan	1:2,500	1975	4
Large-Scale National Grid Data	1:2,500	1994	5

Historical Map - Segment A14

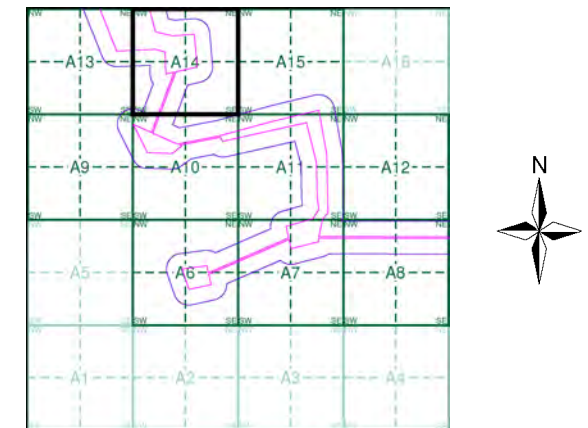

Order Details

Order Number: 297990273_1_1
 Customer Ref: 21-1088.04
 National Grid Reference: 489950, 382840
 Slice: A
 Site Area (Ha): 469.98
 Search Buffer (m): 100

Site Details

Cottam



Tel: [Redacted]
 Fax: [Redacted]
 Web: [Redacted]

Lincolnshire
Published 1886

Source map scale - 1:2,500

The historical maps shown were reproduced from maps predominantly held at the scale adopted for England, Wales and Scotland in the 1840's. In 1854 the 1:2,500 scale was adopted for mapping urban areas and by 1896 it covered the whole of what were considered to be the cultivated parts of Great Britain. The published date given below is often some years later than the surveyed date. Before 1938, all OS maps were based on the Cassini Projection, with independent surveys of a single county or group of counties, giving rise to significant inaccuracies in outlying areas.

Map Name(s) and Date(s)

051_07 1886 1:2,500	051_08 1886 1:2,500
051_11 1886 1:2,500	051_12 1886 1:2,500

Historical Map - Segment A14

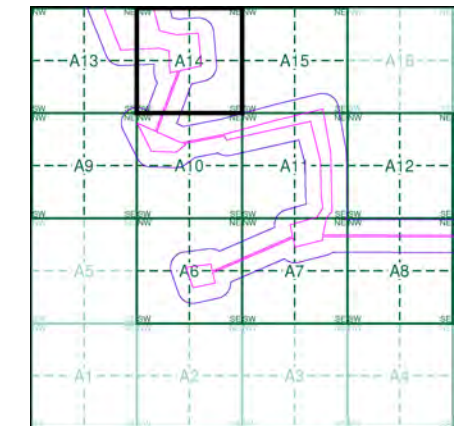

Order Details

Order Number: 297990273_1_1
 Customer Ref: 21-1088.04
 National Grid Reference: 489950, 382840
 Slice: A
 Site Area (Ha): 469.98
 Search Buffer (m): 100

Site Details

Cottam

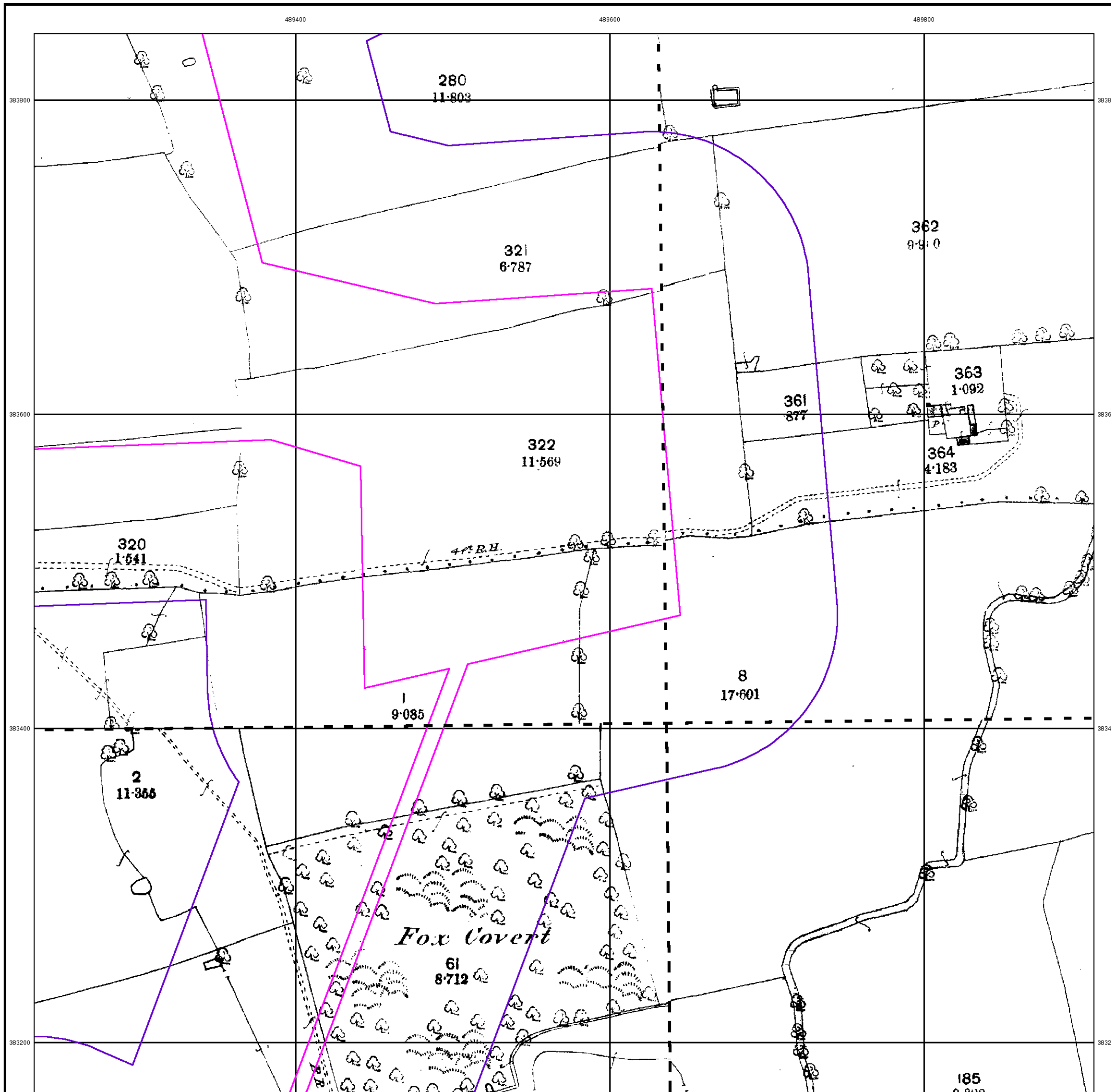

Lincolnshire

Published 1906

Source map scale - 1:2,500

The historical maps shown were reproduced from maps predominantly held at the scale adopted for England, Wales and Scotland in the 1840's. In 1854 the 1:2,500 scale was adopted for mapping urban areas and by 1896 it covered the whole of what were considered to be the cultivated parts of Great Britain. The published date given below is often some years later than the surveyed date. Before 1938, all OS maps were based on the Cassini Projection, with independent surveys of a single county or group of counties, giving rise to significant inaccuracies in outlying areas.

Map Name(s) and Date(s)

051_07 1906 1:2,500	051_08 1906 1:2,500
051_11 1906 1:2,500	051_12 1906 1:2,500

Historical Map - Segment A14

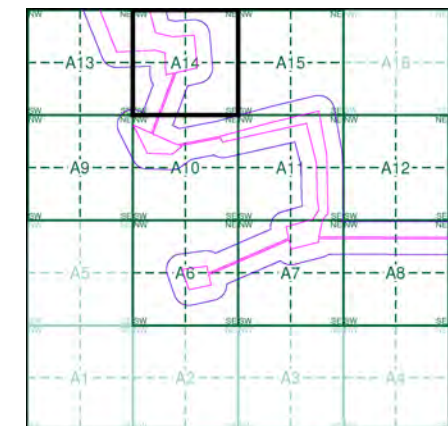

Order Details

Order Number: 297990273_1_1
 Customer Ref: 21-1088.04
 National Grid Reference: 489950, 382840
 Slice: A
 Site Area (Ha): 469.98
 Search Buffer (m): 100

Site Details

Cottam

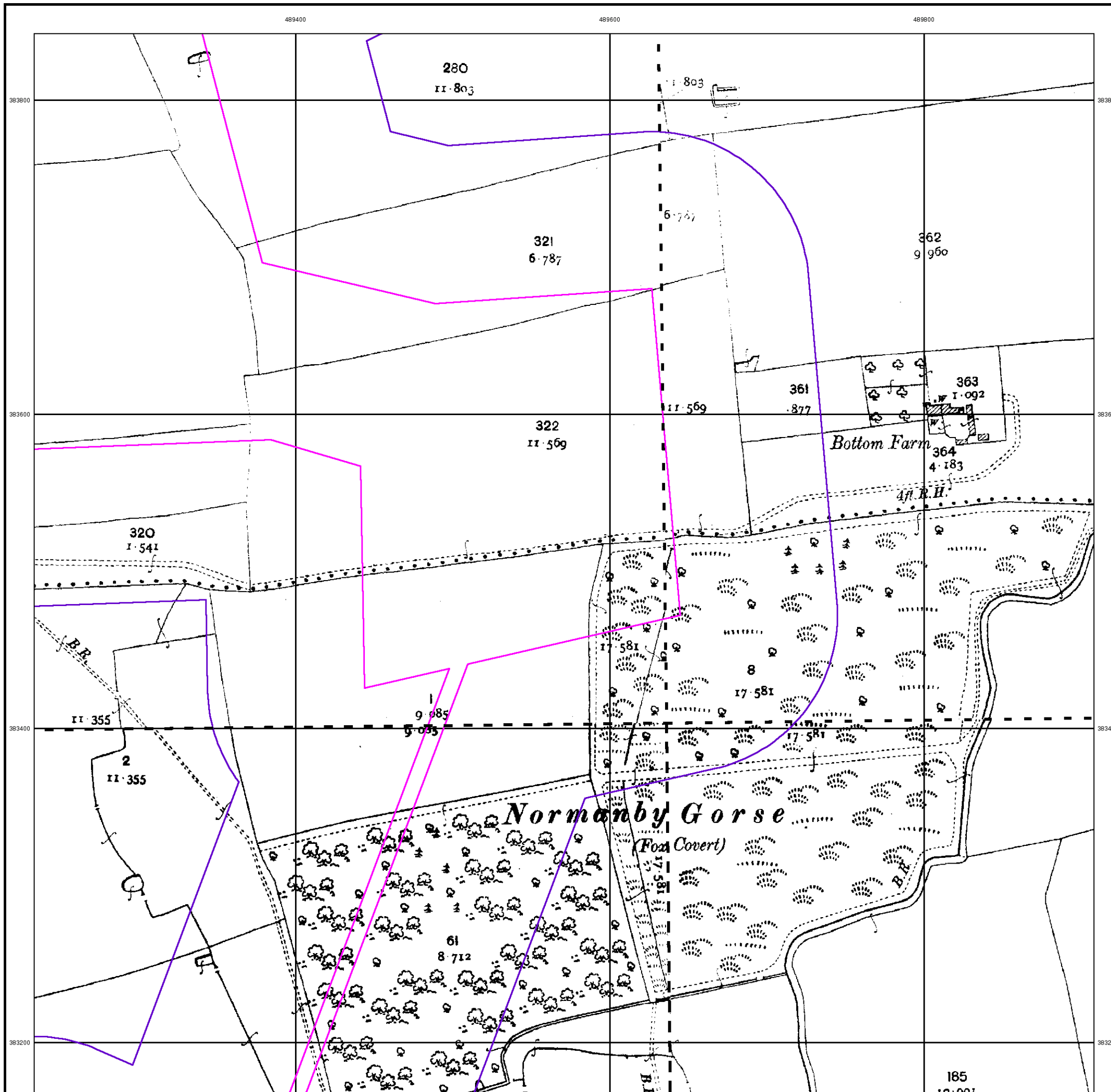

Ordnance Survey Plan

Published 1975

Source map scale - 1:2,500

The historical maps shown were reproduced from maps predominantly held at the scale adopted for England, Wales and Scotland in the 1840's. In 1854 the 1:2,500 scale was adopted for mapping urban areas and by 1896 it covered the whole of what were considered to be the cultivated parts of Great Britain. The published date given below is often some years later than the surveyed date. Before 1938, all OS maps were based on the Cassini Projection, with independent surveys of a single county or group of counties, giving rise to significant inaccuracies in outlying areas.

Map Name(s) and Date(s)

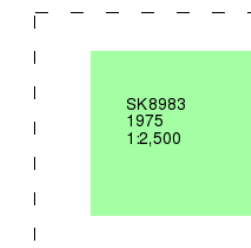

Historical Map - Segment A14

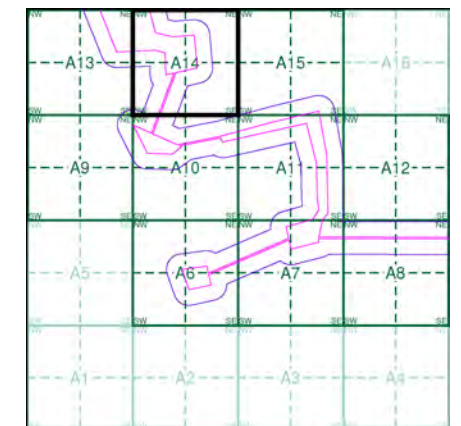

Order Details

Order Number: 297990273_1_1
 Customer Ref: 21-1088.04
 National Grid Reference: 489950, 382840
 Slice: A
 Site Area (Ha): 469.98
 Search Buffer (m): 100

Site Details

Cottam

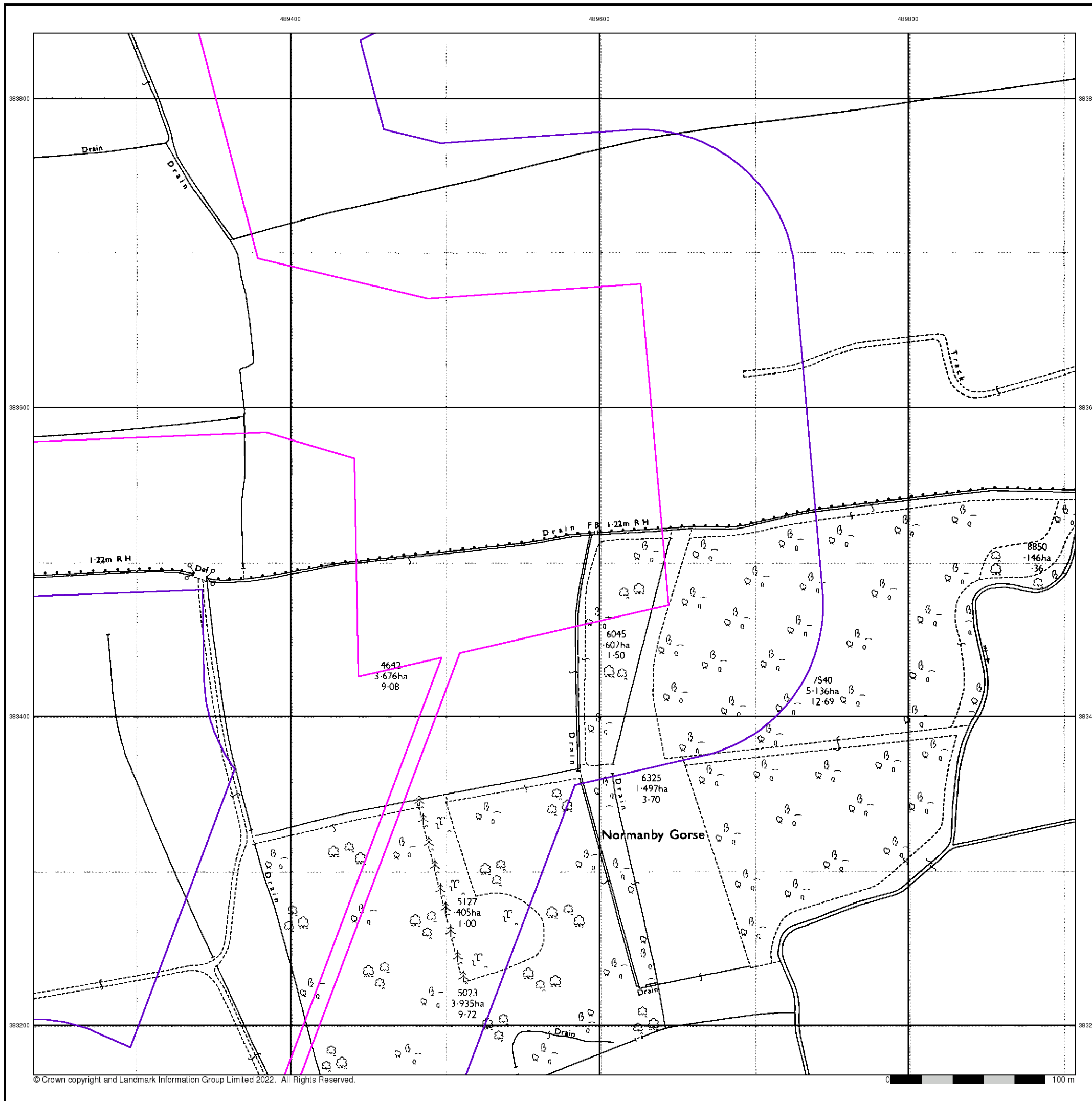

Large-Scale National Grid Data

Published 1994

Source map scale - 1:2,500

'Large Scale National Grid Data' superseded SIM cards (Ordnance Survey's 'Survey of Information on Microfilm') in 1992, and continued to be produced until 1999. These maps were the fore-runners of digital mapping and so provide detailed information on houses and roads, but tend to show less topographic features such as vegetation. These maps were produced at both 1:2,500 and 1:1,250 scales.

Map Name(s) and Date(s)

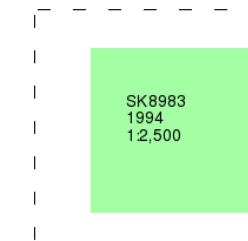

Historical Map - Segment A14

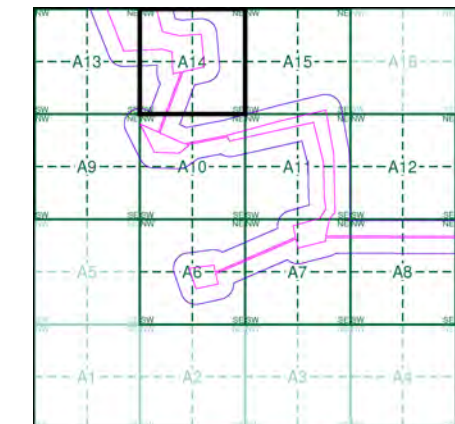

Order Details

Order Number: 297990273_1_1
 Customer Ref: 21-1088.04
 National Grid Reference: 489950, 382840
 Slice: A
 Site Area (Ha): 469.98
 Search Buffer (m): 100

Site Details

Cottam

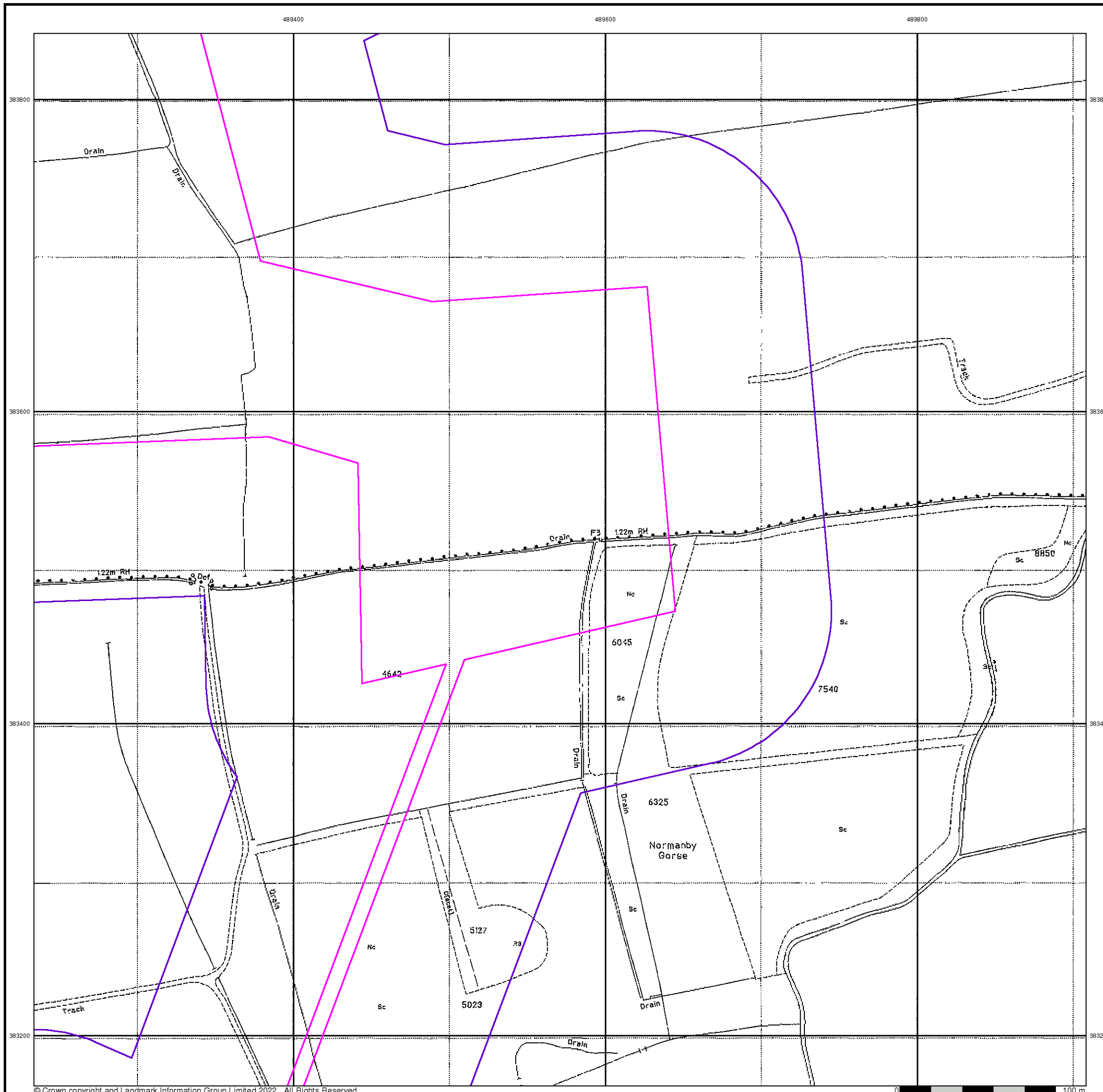

Historical Mapping Legends

Ordnance Survey County Series and Ordnance Survey Plan 1:2,500

Quarry **Gravel Pit** **Sand Pit**
Clay Pit **Shingle** **Refuse Heap**
Sloping Masonry **Flat Rock**
Marsh **Reeds** **Osiers**
Rough Pasture **Furze** **Wood**
Mixed Wood **Brushwood** **Orchard**
Fir **Ford** **Stepping Stones**
Ferry **Waterfall** **Lock**
Trig. Station **Altitude at Trig. Station**
B.M. 325.9 **Bench Mark** **Surface Level**
Arrow denotes flow of water **Antiquities (site of)**
Cutting **Embankment**
Railway crossing Road **Level Crossing** **Road crossing Railway**
Railway crossing River or Canal **Road over single stream** **Road over River or Canal**
County Boundary (Geographical)
County & Civil Parish Boundary
Administrative County & Civil Parish Boundary
County Borough Boundary (England)
Co. Boro. Bdy.
County Burgh Boundary (Scotland)
Co. Burgh Bdy.
BP BS Boundary Post or Stone **P.C.B** Police Call Box
B.R. Bridle Road **P** Pump
E.P Electricity Pylon **S.P** Signal Post
F.B. Foot Bridge **SL** Sluice
F.P. Foot Path **Sp.** Spring
G.P Guide Post or Board **T.C.B** Telephone Call Box
M.S Mile Stone **Tr.** Trough
M.P M.R Mooring Post or Ring **W** Well

Ordnance Survey Plan, Additional SIMs and Supply of Unpublished Survey Information 1:2,500 and 1:1,250

Inactive Quarry, Chalk Pit or Clay Pit **Active Quarry, Chalk Pit or Clay Pit**
Rock **Boulders**
Cliff **Slopes** **Top**
Roofed Building **Glazed Roof Building**
Sloping Masonry **Archway**
Non-Coniferous Tree (surveyed) **Coniferous Tree (surveyed)**
Non-Coniferous Trees (not surveyed) **Coniferous Trees (not surveyed)**
Orchard Tree **Scrub** **Bracken**
Coppice, Osier **Reeds** **Marsh, Saltings**
Rough Grassland **Heath** **Culvert**
Direction of water flow **Bench Mark** **Antiquity (site of)**
Cave Entrance **Triangulation Station** **Electricity Pylon**
Electricity Transmission Line
County Boundary (Geographical)
County & Civil Parish Boundary
Civil Parish Boundary
Admin. County or County Bor. Boundary
London Borough Boundary
Symbol marking point where boundary mereing changes
BH Beer House **P** Pillar, Pole or Post
BP, BS Boundary Post or Stone **PO** Post Office
Cn, C Capstan, Crane **PC** Public Convenience
Chy Chimney **PH** Public House
D Fn Drinking Fountain **Pp** Pump
EI P Electricity Pillar or Post **SB, S Br** Signal Box or Bridge
FAP Fire Alarm Pillar **SP, SL** Signal Post or Light
FB Foot Bridge **Spr** Spring
GP Guide Post **Tk** Tank or Track
H Hydrant or Hydraulic **TCB** Telephone Call Box
LC Level Crossing **TCP** Telephone Call Post
MH Manhole **Tr** Trough
MP Mile Post or Mooring Post **Wr Pt, Wr T** Water Point, Water Tap
MS Mile Stone **W** Well
NTL Normal Tidal Limit **Wd Pp** Wind Pump

Large-Scale National Grid Data 1:2,500 and 1:1,250

Cliff **Slopes** **Top**
Rock **Rock (scattered)**
Boulders **Boulders (scattered)**
Positioned Boulder **Scree**
Non-Coniferous Tree (surveyed) **Coniferous Tree (surveyed)**
Non-Coniferous Trees (not surveyed) **Coniferous Trees (not surveyed)**
Orchard Tree **Scrub** **Bracken**
Coppice, Osier **Reeds** **Marsh, Saltings**
Rough Grassland **Heath** **Culvert**
Direction of water flow **Triangulation Station** **Antiquity (site of)**
Electricity Transmission Line **Electricity Pylon**
B.M. 231.60m Bench Mark **Buildings with Building Seed**
Roofed Building **Glazed Roof Building**
Civil parish/community boundary
District boundary
County boundary
Boundary post/stone
Boundary mereing symbol (note: these always appear in opposed pairs or groups of three)
Bks Barracks **P** Pillar, Pole or Post
Bty Battery **PO** Post Office
Cemy Cemetery **PC** Public Convenience
Chy Chimney **Pp** Pump
Cis Cistern **Ppg Sta** Pumping Station
Dismtd Rly Dismantled Railway **PW** Place of Worship
EI Gen Sta Electricity Generating Station **Sewage Ppg Sta** Sewage Pumping Station
EI P Electricity Pole, Pillar **SB, S Br** Signal Box or Bridge
EI Sub Sta Electricity Sub Station **SP, SL** Signal Post or Light
FB Filter Bed **Spr** Spring
Fn / D Fn Fountain / Drinking Ftn. **Tk** Tank or Track
Gas Gov Gas Valve Compound **Tr** Trough
GVC Gas Governor **Wd Pp** Wind Pump
GP Guide Post **Wr Pt, Wr T** Water Point, Water Tap
MH Manhole **Wks** Works (building or area)
MP, MS Mile Post or Mile Stone **W** Well



Historical Mapping & Photography included:

Mapping Type	Scale	Date	Pg
Lincolnshire	1:2,500	1886	2
Lincolnshire	1:2,500	1906	3
Ordnance Survey Plan	1:2,500	1974 - 1975	4
Large-Scale National Grid Data	1:2,500	1994	5

Historical Map - Segment A15

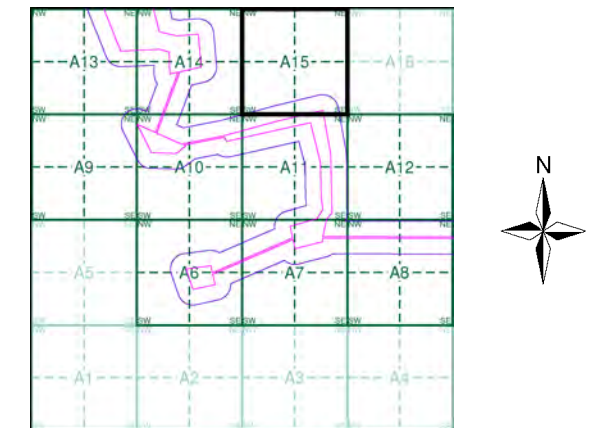

Order Details

Order Number: 297990273_1_1
 Customer Ref: 21-1088.04
 National Grid Reference: 489950, 382840
 Slice: A
 Site Area (Ha): 469.98
 Search Buffer (m): 100

Site Details

Cottam



Tel: [Redacted]
 Fax: [Redacted]
 Web: [Redacted]

Lincolnshire
Published 1886

Source map scale - 1:2,500

The historical maps shown were reproduced from maps predominantly held at the scale adopted for England, Wales and Scotland in the 1840's. In 1854 the 1:2,500 scale was adopted for mapping urban areas and by 1896 it covered the whole of what were considered to be the cultivated parts of Great Britain. The published date given below is often some years later than the surveyed date. Before 1938, all OS maps were based on the Cassini Projection, with independent surveys of a single county or group of counties, giving rise to significant inaccuracies in outlying areas.

Map Name(s) and Date(s)

051_08
1886
1:2,500
051_12
1886
1:2,500

Historical Map - Segment A15

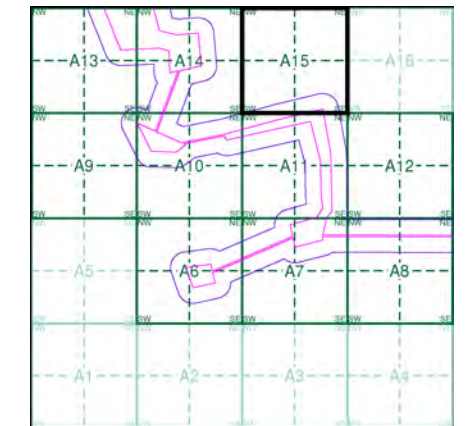

Order Details

Order Number: 297990273_1_1
 Customer Ref: 21-1088.04
 National Grid Reference: 489950, 382840
 Slice: A
 Site Area (Ha): 469.98
 Search Buffer (m): 100

Site Details

Cottam

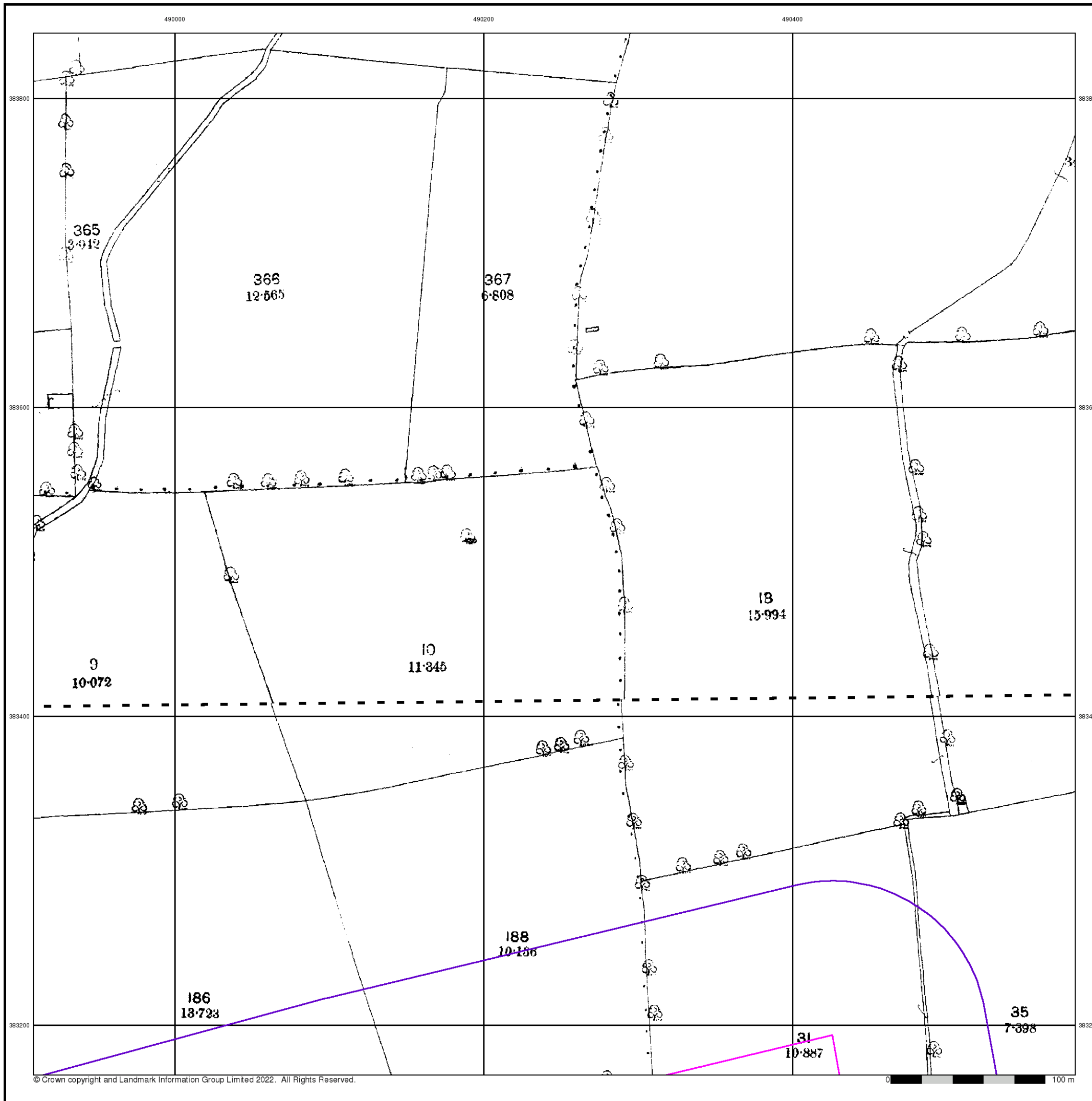

Lincolnshire

Published 1906

Source map scale - 1:2,500

The historical maps shown were reproduced from maps predominantly held at the scale adopted for England, Wales and Scotland in the 1840's. In 1854 the 1:2,500 scale was adopted for mapping urban areas and by 1896 it covered the whole of what were considered to be the cultivated parts of Great Britain. The published date given below is often some years later than the surveyed date. Before 1938, all OS maps were based on the Cassini Projection, with independent surveys of a single county or group of counties, giving rise to significant inaccuracies in outlying areas.

Map Name(s) and Date(s)

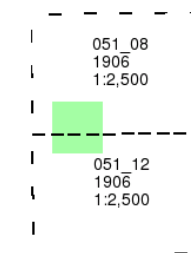

Historical Map - Segment A15

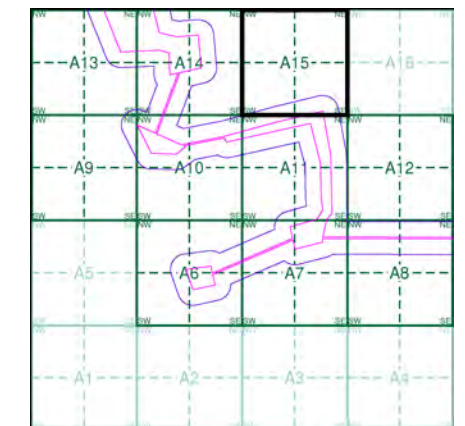

Order Details

Order Number: 297990273_1_1
 Customer Ref: 21-1088.04
 National Grid Reference: 489950, 382840
 Slice: A
 Site Area (Ha): 469.98
 Search Buffer (m): 100

Site Details

Cottam

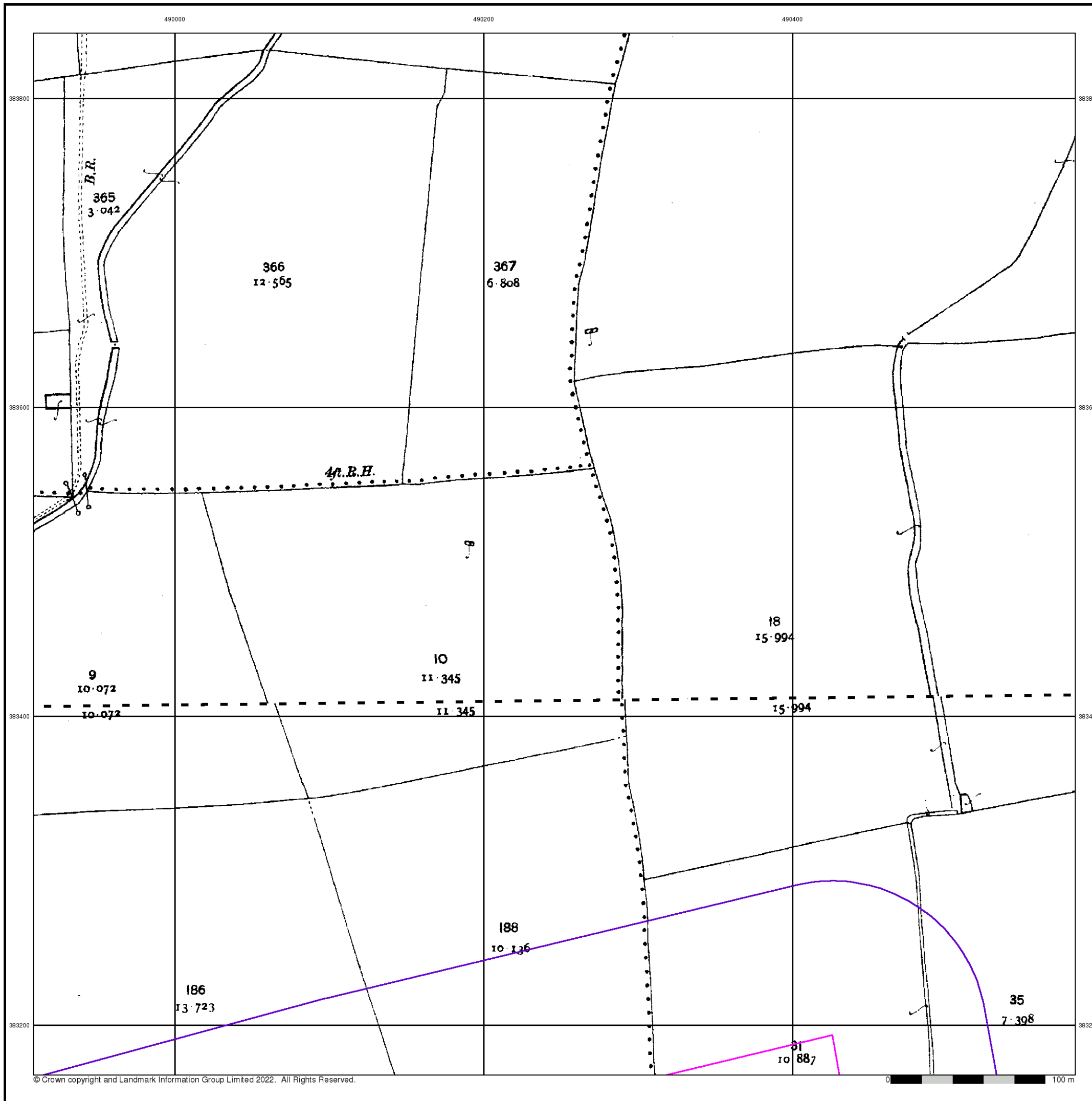

Ordnance Survey Plan
Published 1974 - 1975
Source map scale - 1:2,500

The historical maps shown were reproduced from maps predominantly held at the scale adopted for England, Wales and Scotland in the 1840's. In 1854 the 1:2,500 scale was adopted for mapping urban areas and by 1896 it covered the whole of what were considered to be the cultivated parts of Great Britain. The published date given below is often some years later than the surveyed date. Before 1938, all OS maps were based on the Cassini Projection, with independent surveys of a single county or group of counties, giving rise to significant inaccuracies in outlying areas.

Map Name(s) and Date(s)

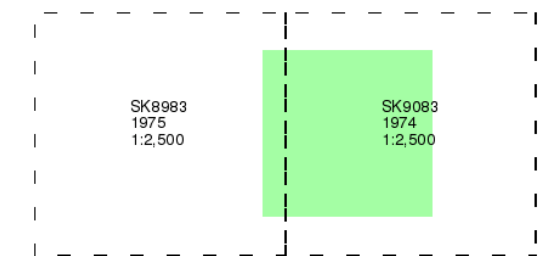

Historical Map - Segment A15

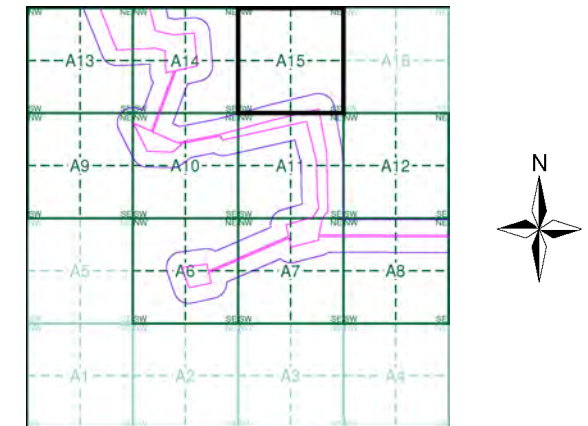

Order Details

Order Number: 297990273_1_1
 Customer Ref: 21-1088.04
 National Grid Reference: 489950, 382840
 Slice: A
 Site Area (Ha): 469.98
 Search Buffer (m): 100

Site Details

Cottam

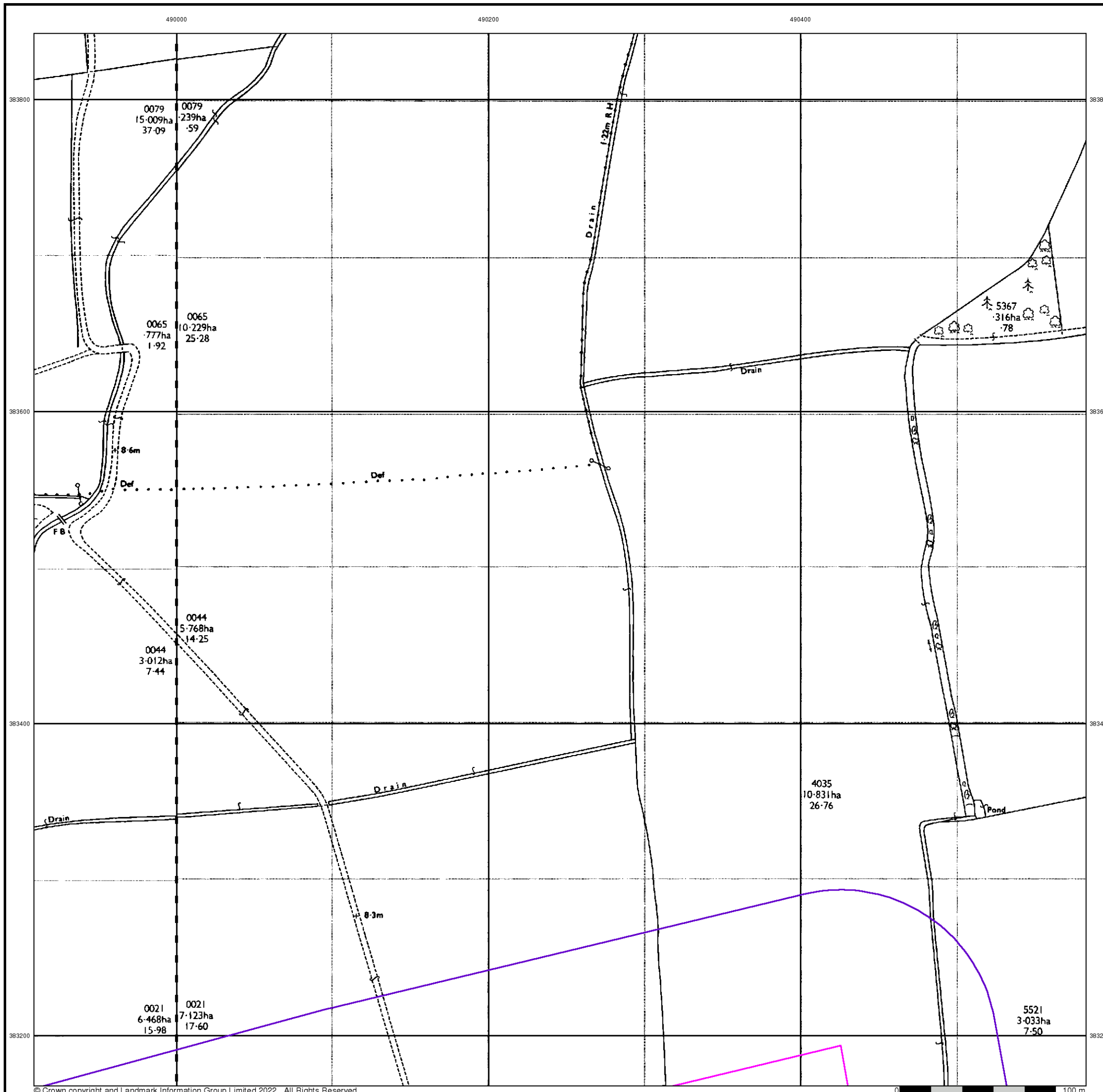

Large-Scale National Grid Data

Published 1994

Source map scale - 1:2,500

'Large Scale National Grid Data' superseded SIM cards (Ordnance Survey's 'Survey of Information on Microfilm') in 1992, and continued to be produced until 1999. These maps were the fore-runners of digital mapping and so provide detailed information on houses and roads, but tend to show less topographic features such as vegetation. These maps were produced at both 1:2,500 and 1:1,250 scales.

Map Name(s) and Date(s)

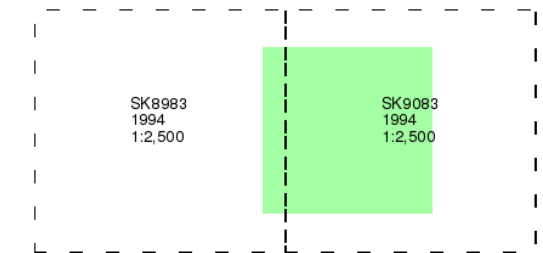

Historical Map - Segment A15

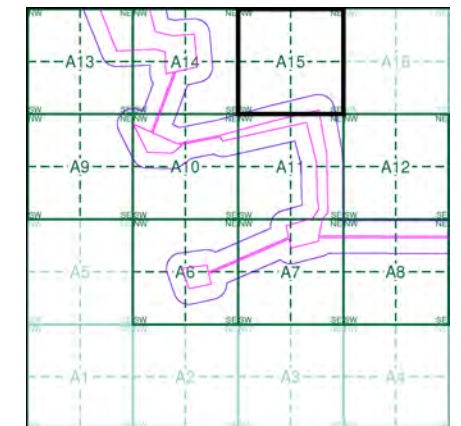

Order Details

Order Number: 297990273_1_1
 Customer Ref: 21-1088.04
 National Grid Reference: 489950, 382840
 Slice: A
 Site Area (Ha): 469.98
 Search Buffer (m): 100

Site Details

Cottam



Historical Mapping Legends

Ordnance Survey County Series 1:10,560

	Gravel Pit		Sand Pit		Other Pits
	Quarry		Shingle		Orchard
	Osiers		Reeds		Marsh
	Mixed Wood		Deciduous		Brushwood
	Fir		Furze		Rough Pasture
	Arrow denotes flow of water		Trigonometrical Station		
	Site of Antiquities		Bench Mark		
	Pump, Guide Post, Signal Post		Well, Spring, Boundary Post		
	-285 Surface Level				
	Sketched Contour		Instrumental Contour		
	Main Roads		Minor Roads		
	Sunken Road		Raised Road		
	Road over Railway		Railway over River		
	Railway over Road		Level Crossing		
	Road over River or Canal		Road over Stream		
	Road over Stream				
	County Boundary (Geographical)				
	County & Civil Parish Boundary				
	Administrative County & Civil Parish Boundary				
	County Borough Boundary (England)				
	County Burgh Boundary (Scotland)				
	Rural District Boundary				
	Civil Parish Boundary				

Ordnance Survey Plan 1:10,000

	Chalk Pit, Clay Pit or Quarry		Gravel Pit
	Sand Pit		Disused Pit or Quarry
	Refuse or Slag Heap		Lake, Loch or Pond
	Dunes		Boulders
	Coniferous Trees		Non-Coniferous Trees
	Orchard		Scrub
	Coppice		Bracken
	Heath		Rough Grassland
	Marsh		Reeds
	Saltings		
	Building		Glasshouse
	Sloping Masonry		Pylon
	Electricity Transmission Line		Pole
	Cutting		Embankment
	Standard Gauge Multiple Track		Standard Gauge Single Track
	Siding, Tramway or Mineral Line		Narrow Gauge
	Geographical County		
	Administrative County, County Borough or County of City		
	Municipal Borough, Urban or Rural District, Burgh or District Council		
	Borough, Burgh or County Constituency Shown only when not coincident with other boundaries		
	Civil Parish Shown alternately when coincidence of boundaries occurs		
	BP, BS Boundary Post or Stone		Pol Sta Police Station
	Ch Church		PO Post Office
	CH Club House		PC Public Convenience
	F E Sta Fire Engine Station		PH Public House
	FB Foot Bridge		SB Signal Box
	Fn Fountain		Spr Spring
	GP Guide Post		TCB Telephone Call Box
	MP Mile Post		TCP Telephone Call Post
	MS Mile Stone		W Well

1:10,000 Raster Mapping

	Gravel Pit		Refuse tip or slag heap
	Rock		Rock (scattered)
	Boulders		Boulders (scattered)
	Shingle		Mud
	Sand		Sand Pit
	Slopes		Top of cliff
	General detail		Underground detail
	Overhead detail		Narrow gauge railway
	Multi-track railway		Single track railway
	County boundary (England only)		Civil, parish or community boundary
	District, Unitary, Metropolitan, London Borough boundary		Constituency boundary
	Area of wooded vegetation		Non-coniferous trees
	Non-coniferous trees (scattered)		Coniferous trees
	Coniferous trees (scattered)		Positioned tree
	Orchard		Coppice or Osiers
	Rough Grassland		Heath
	Scrub		Marsh, Salt Marsh or Reeds
	Water feature		Flow arrows
	MHW(S) Mean high water (springs)		MLW(S) Mean low water (springs)
	Telephone line (where shown)		Electricity transmission line (with poles)
	Bench mark (where shown)		Triangulation station
	Point feature (e.g. Guide Post or Mile Stone)		Pylon, flare stack or lighting tower
	Site of (antiquity)		Glasshouse
	General Building		Important Building



Historical Mapping & Photography included:

Mapping Type	Scale	Date	Pg
Lincolnshire	1:10,560	1885 - 1886	2
Lincolnshire	1:10,560	1907	3
Lincolnshire	1:10,560	1907	4
Lincolnshire	1:10,560	1947 - 1948	5
Ordnance Survey Plan	1:10,000	1956	6
Ordnance Survey Plan	1:10,000	1979	7
10K Raster Mapping	1:10,000	2000	8
Street View	Variable		9

Historical Map - Slice B

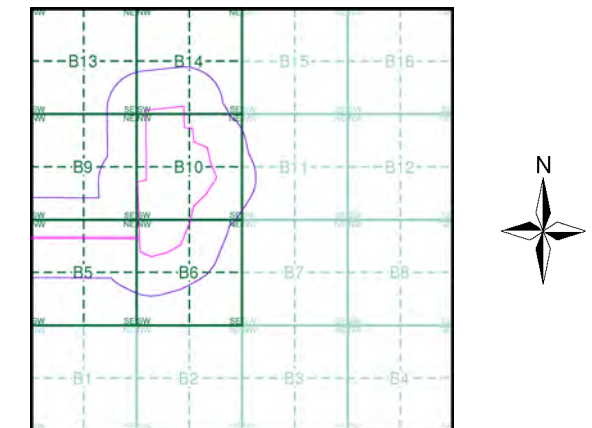

Order Details

Order Number: 297990273_1_1
 Customer Ref: 21-1088.04
 National Grid Reference: 492030, 382680
 Slice: B
 Site Area (Ha): 469.98
 Search Buffer (m): 250

Site Details

Cottam



Tel: [Redacted]
 Fax: [Redacted]
 Web: [Redacted]

Lincolnshire

Published 1885 - 1886

Source map scale - 1:10,560

The historical maps shown were reproduced from maps predominantly held at the scale adopted for England, Wales and Scotland in the 1840's. In 1854 the 1:2,500 scale was adopted for mapping urban areas; these maps were used to update the 1:10,560 maps. The published date given therefore is often some years later than the surveyed date. Before 1938, all OS maps were based on the Cassini Projection, with independent surveys of a single county or group of counties, giving rise to significant inaccuracies in outlying areas. In the late 1940's, a Provisional Edition was produced, which updated the 1:10,560 mapping from a number of sources. The maps appear unfinished - with all military camps and other strategic sites removed. These maps were initially overprinted with the National Grid. In 1970, the first 1:10,000 maps were produced using the Transverse Mercator Projection. The revision process continued until recently, with new editions appearing every 10 years or so for urban areas.

Map Name(s) and Date(s)

051NE 1885 1:10,560	052NW 1886 1:10,560
051SE 1885 1:10,560	052SW 1885 1:10,560

Historical Map - Slice B

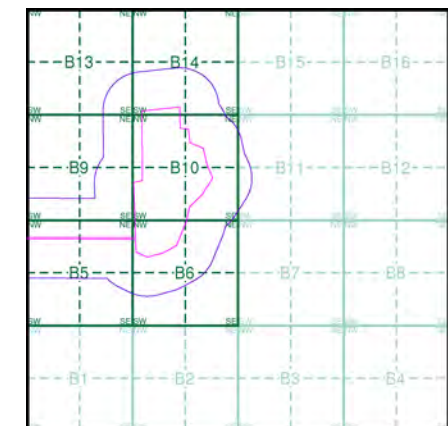

Order Details

Order Number: 297990273_1_1
 Customer Ref: 21-1088.04
 National Grid Reference: 492030, 382680
 Slice: B
 Site Area (Ha): 469.98
 Search Buffer (m): 250

Site Details

Cottam

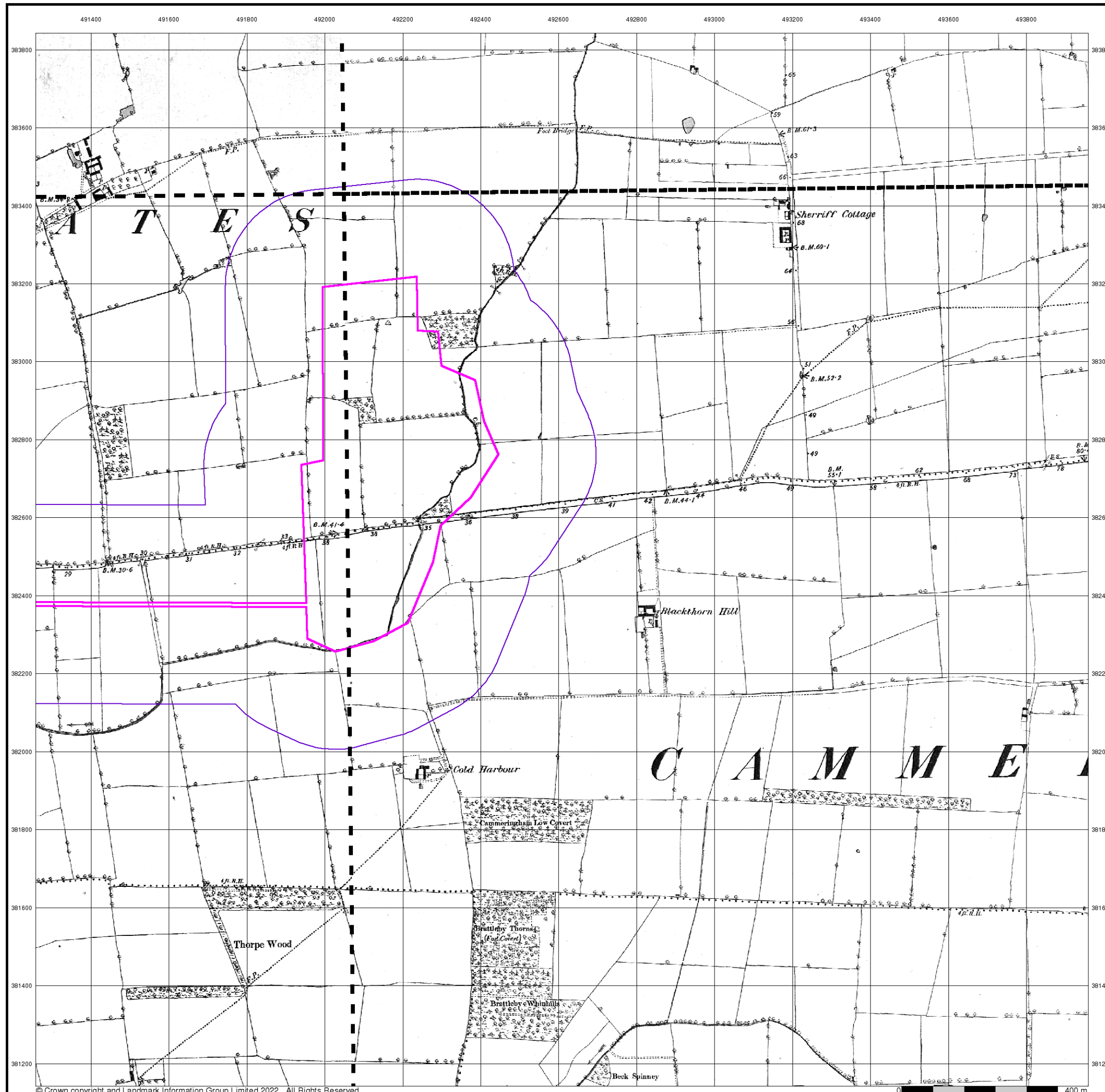

Lincolnshire

Published 1907

Source map scale - 1:10,560

The historical maps shown were reproduced from maps predominantly held at the scale adopted for England, Wales and Scotland in the 1840's. In 1854 the 1:2,500 scale was adopted for mapping urban areas; these maps were used to update the 1:10,560 maps. The published date given therefore is often some years later than the surveyed date. Before 1938, all OS maps were based on the Cassini Projection, with independent surveys of a single county or group of counties, giving rise to significant inaccuracies in outlying areas. In the late 1940's, a Provisional Edition was produced, which updated the 1:10,560 mapping from a number of sources. The maps appear unfinished - with all military camps and other strategic sites removed. These maps were initially overprinted with the National Grid. In 1970, the first 1:10,000 maps were produced using the Transverse Mercator Projection. The revision process continued until recently, with new editions appearing every 10 years or so for urban areas.

Map Name(s) and Date(s)

051NE 1907 1:10,560	052NW 1907 1:10,560
051SE 1907 1:10,560	052SW 1907 1:10,560

Historical Map - Slice B

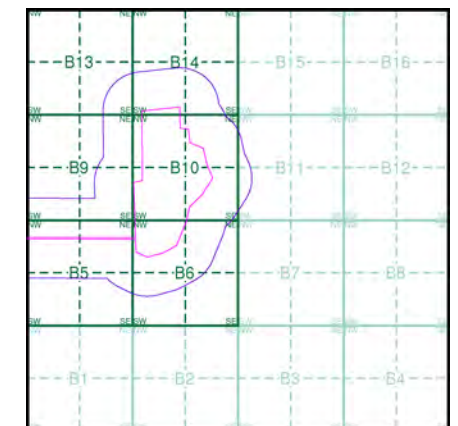

Order Details

Order Number: 297990273_1_1
 Customer Ref: 21-1088.04
 National Grid Reference: 492030, 382680
 Slice: B
 Site Area (Ha): 469.98
 Search Buffer (m): 250

Site Details

Cottam

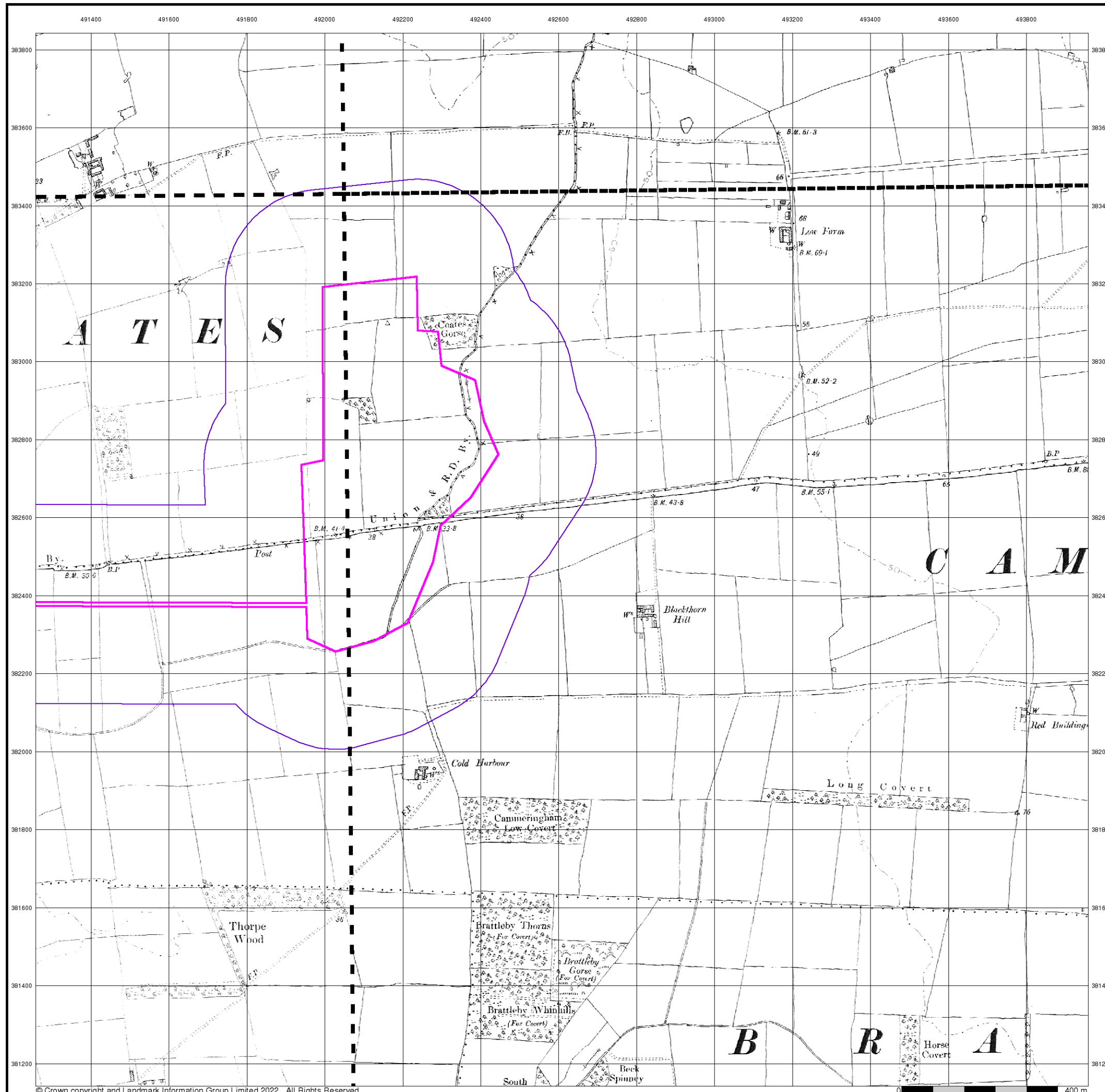

Lincolnshire

Published 1907

Source map scale - 1:10,560

The historical maps shown were reproduced from maps predominantly held at the scale adopted for England, Wales and Scotland in the 1840's. In 1854 the 1:2,500 scale was adopted for mapping urban areas; these maps were used to update the 1:10,560 maps. The published date given therefore is often some years later than the surveyed date. Before 1938, all OS maps were based on the Cassini Projection, with independent surveys of a single county or group of counties, giving rise to significant inaccuracies in outlying areas. In the late 1940's, a Provisional Edition was produced, which updated the 1:10,560 mapping from a number of sources. The maps appear unfinished - with all military camps and other strategic sites removed. These maps were initially overprinted with the National Grid. In 1970, the first 1:10,000 maps were produced using the Transverse Mercator Projection. The revision process continued until recently, with new editions appearing every 10 years or so for urban areas.

Map Name(s) and Date(s)

	052NW 1907 1:10,560
051SE 1907 1:10,560	052SW 1907 1:10,560

Historical Map - Slice B

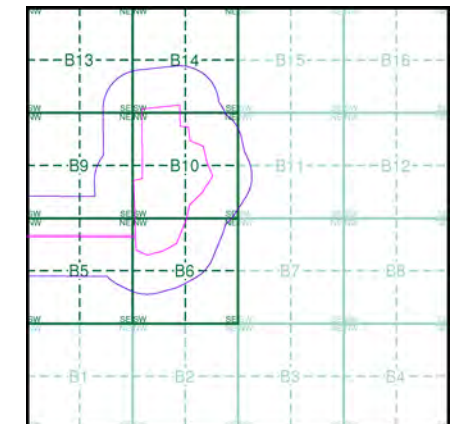

Order Details

Order Number: 297990273_1_1
 Customer Ref: 21-1088.04
 National Grid Reference: 492030, 382680
 Slice: B
 Site Area (Ha): 469.98
 Search Buffer (m): 250

Site Details

Cottam

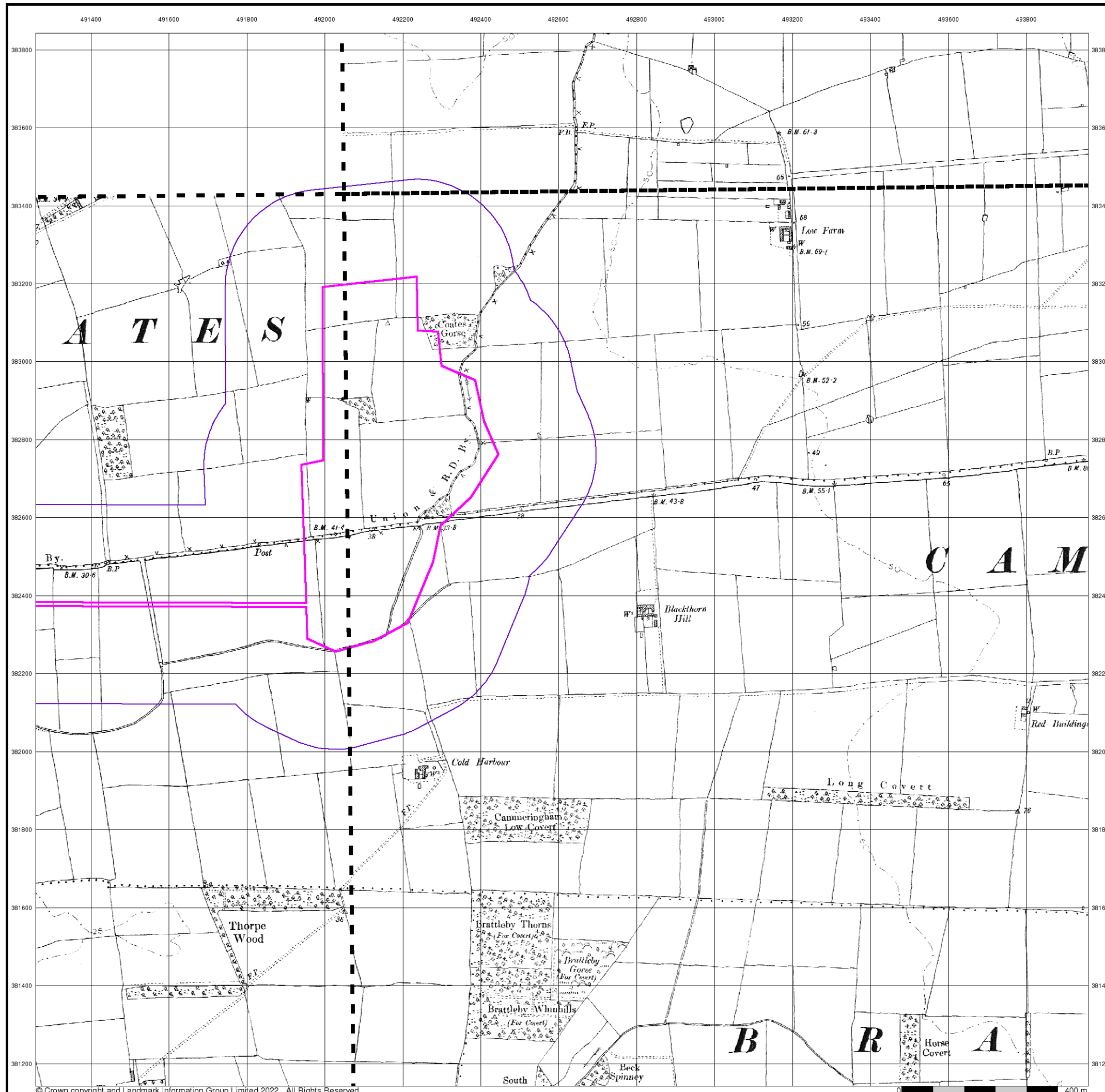

Lincolnshire

Published 1947 - 1948

Source map scale - 1:10,560

The historical maps shown were reproduced from maps predominantly held at the scale adopted for England, Wales and Scotland in the 1840's. In 1854 the 1:2,500 scale was adopted for mapping urban areas; these maps were used to update the 1:10,560 maps. The published date given therefore is often some years later than the surveyed date. Before 1938, all OS maps were based on the Cassini Projection, with independent surveys of a single county or group of counties, giving rise to significant inaccuracies in outlying areas. In the late 1940's, a Provisional Edition was produced, which updated the 1:10,560 mapping from a number of sources. The maps appear unfinished - with all military camps and other strategic sites removed. These maps were initially overprinted with the National Grid. In 1970, the first 1:10,000 maps were produced using the Transverse Mercator Projection. The revision process continued until recently, with new editions appearing every 10 years or so for urban areas.

Map Name(s) and Date(s)

051NE 1947 1:10,560	052NW 1947 1:10,560
051SE 1947 1:10,560	052SW 1948 1:10,560

Historical Map - Slice B

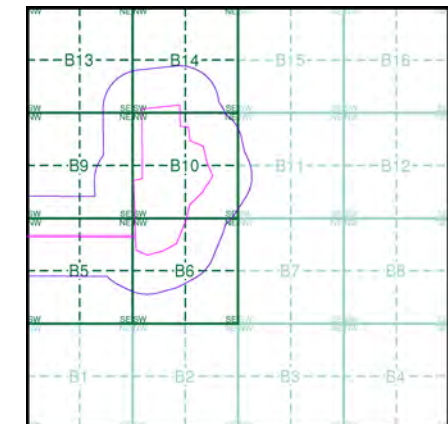

Order Details

Order Number: 297990273_1_1
 Customer Ref: 21-1088.04
 National Grid Reference: 492030, 382680
 Slice: B
 Site Area (Ha): 469.98
 Search Buffer (m): 250

Site Details

Cottam

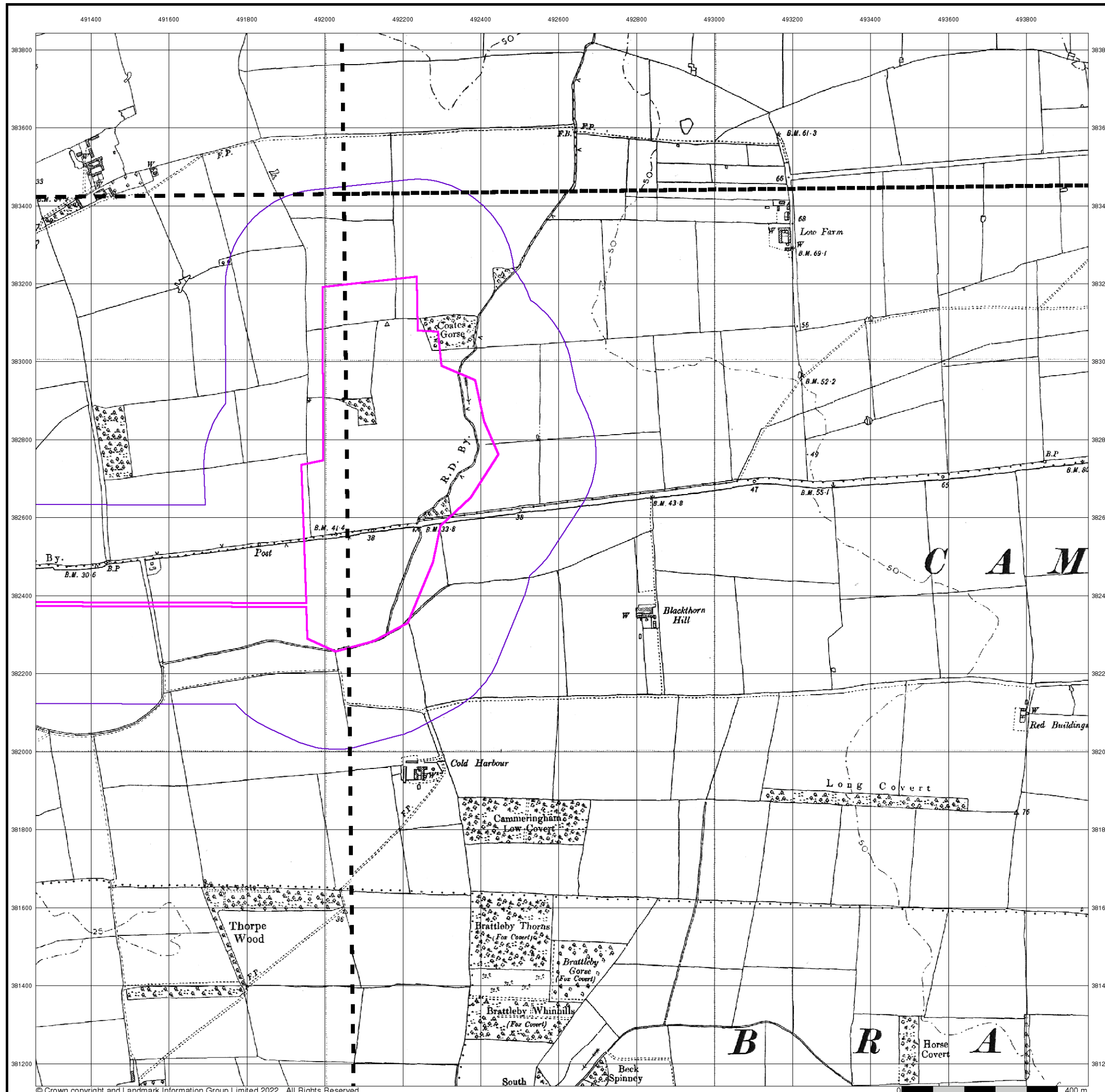

Ordnance Survey Plan

Published 1956

Source map scale - 1:10,000

The historical maps shown were reproduced from maps predominantly held at the scale adopted for England, Wales and Scotland in the 1840's. In 1854 the 1:2,500 scale was adopted for mapping urban areas; these maps were used to update the 1:10,560 maps. The published date given therefore is often some years later than the surveyed date. Before 1938, all OS maps were based on the Cassini Projection, with independent surveys of a single county or group of counties, giving rise to significant inaccuracies in outlying areas. In the late 1940's, a Provisional Edition was produced, which updated the 1:10,560 mapping from a number of sources. The maps appear unfinished - with all military camps and other strategic sites removed. These maps were initially overprinted with the National Grid. In 1970, the first 1:10,000 maps were produced using the Transverse Mercator Projection. The revision process continued until recently, with new editions appearing every 10 years or so for urban areas.

Map Name(s) and Date(s)

SK98SW
1956
1:10,560

Historical Map - Slice B

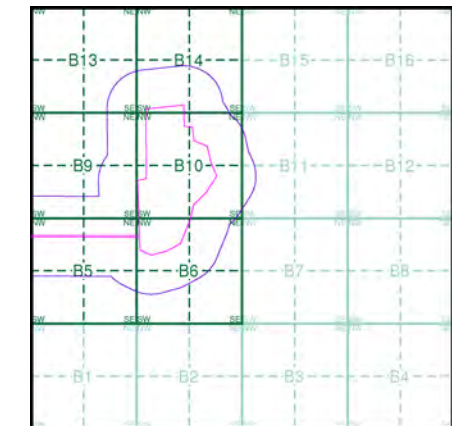

Order Details

Order Number: 297990273_1_1
 Customer Ref: 21-1088.04
 National Grid Reference: 492030, 382680
 Slice: B
 Site Area (Ha): 469.98
 Search Buffer (m): 250

Site Details

Cottam

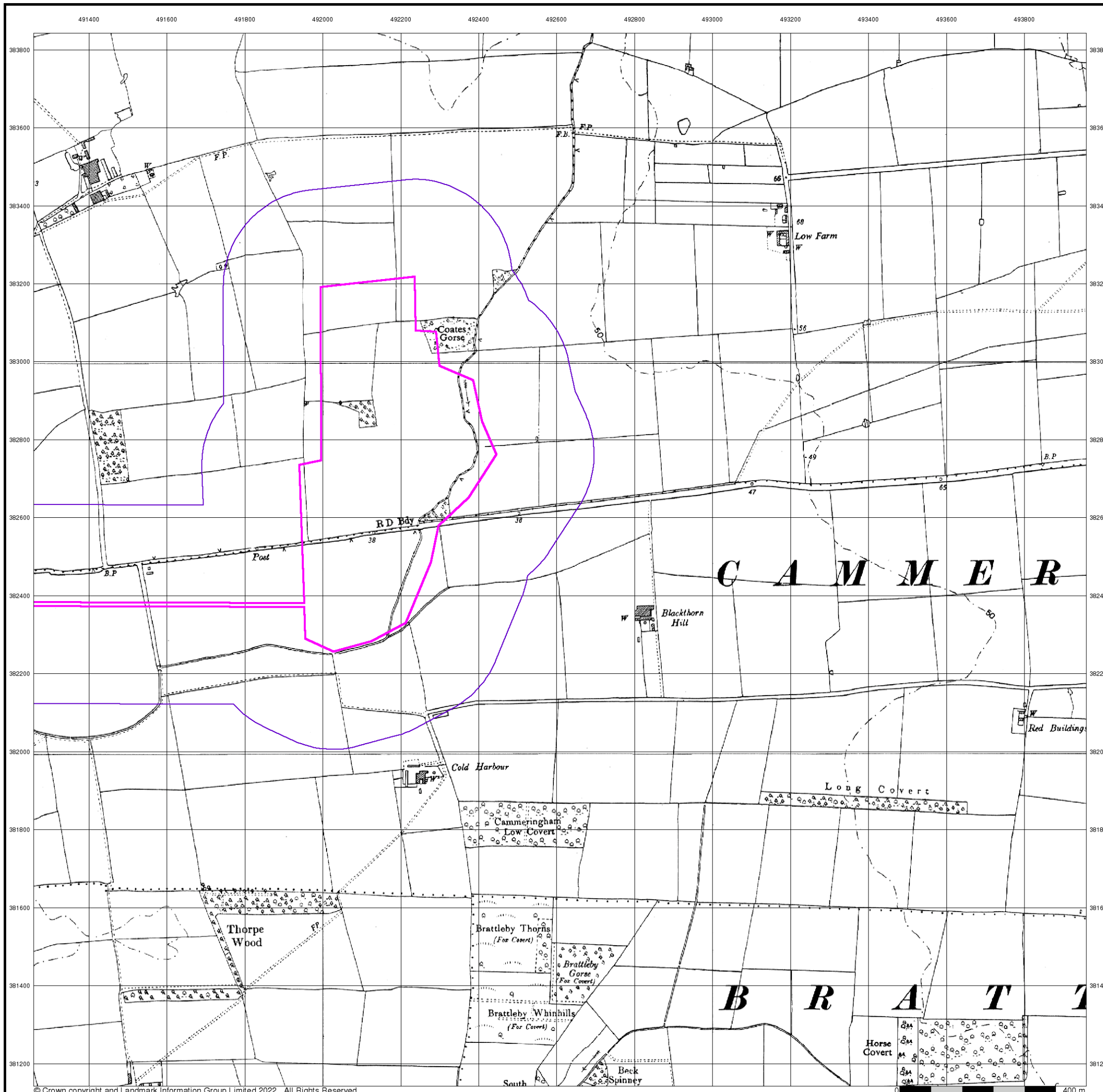

Ordnance Survey Plan

Published 1979

Source map scale - 1:10,000

The historical maps shown were reproduced from maps predominantly held at the scale adopted for England, Wales and Scotland in the 1840's. In 1854 the 1:2,500 scale was adopted for mapping urban areas; these maps were used to update the 1:10,560 maps. The published date given therefore is often some years later than the surveyed date. Before 1938, all OS maps were based on the Cassini Projection, with independent surveys of a single county or group of counties, giving rise to significant inaccuracies in outlying areas. In the late 1940's, a Provisional Edition was produced, which updated the 1:10,560 mapping from a number of sources. The maps appear unfinished - with all military camps and other strategic sites removed. These maps were initially overprinted with the National Grid. In 1970, the first 1:10,000 maps were produced using the Transverse Mercator Projection. The revision process continued until recently, with new editions appearing every 10 years or so for urban areas.

Map Name(s) and Date(s)

SK98SW
1979
1:10,000

Historical Map - Slice B

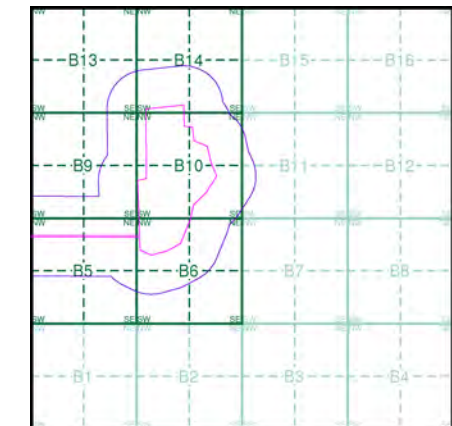

Order Details

Order Number: 297990273_1_1
 Customer Ref: 21-1088.04
 National Grid Reference: 492030, 382680
 Slice: B
 Site Area (Ha): 469.98
 Search Buffer (m): 250

Site Details

Cottam

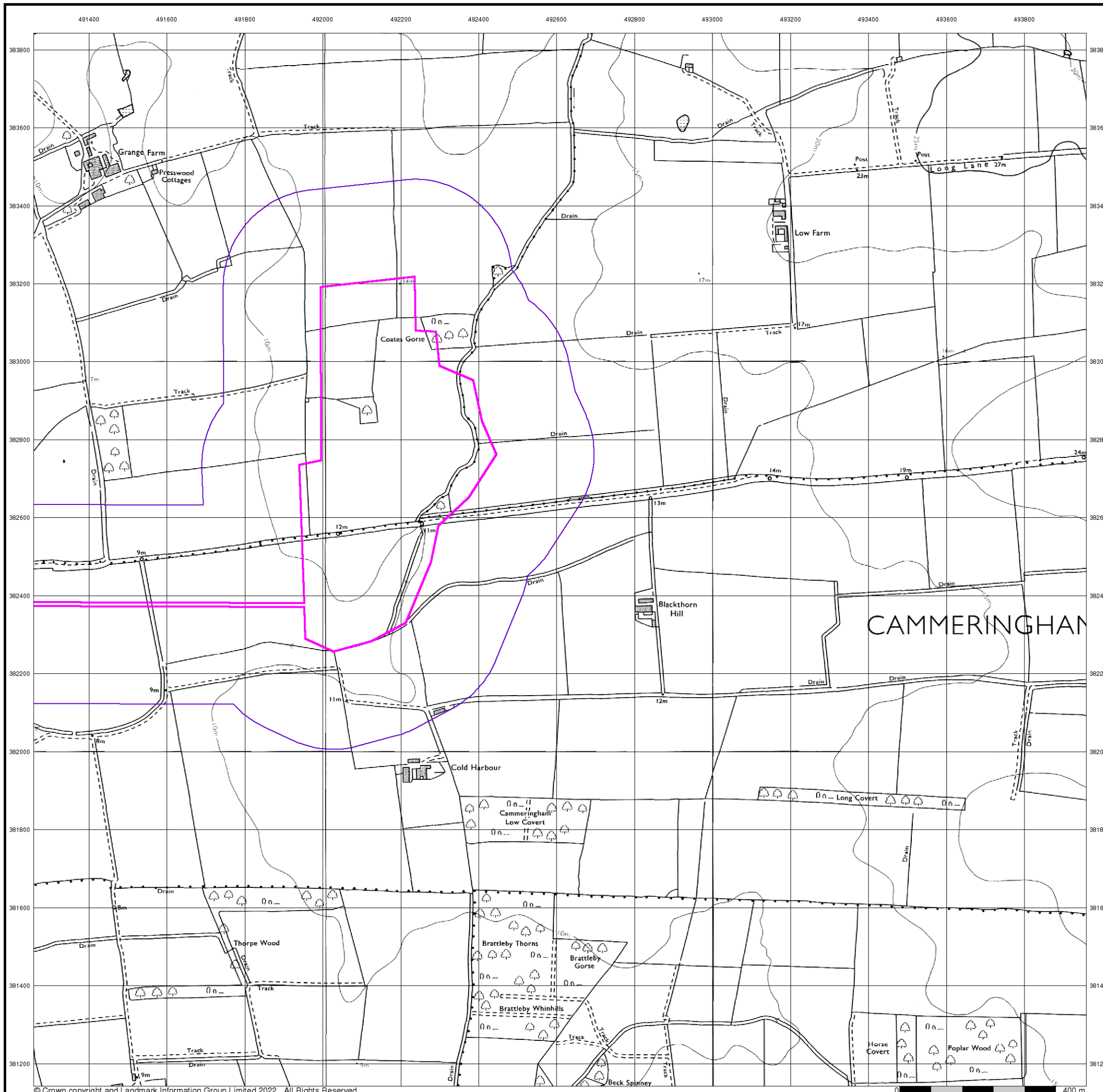

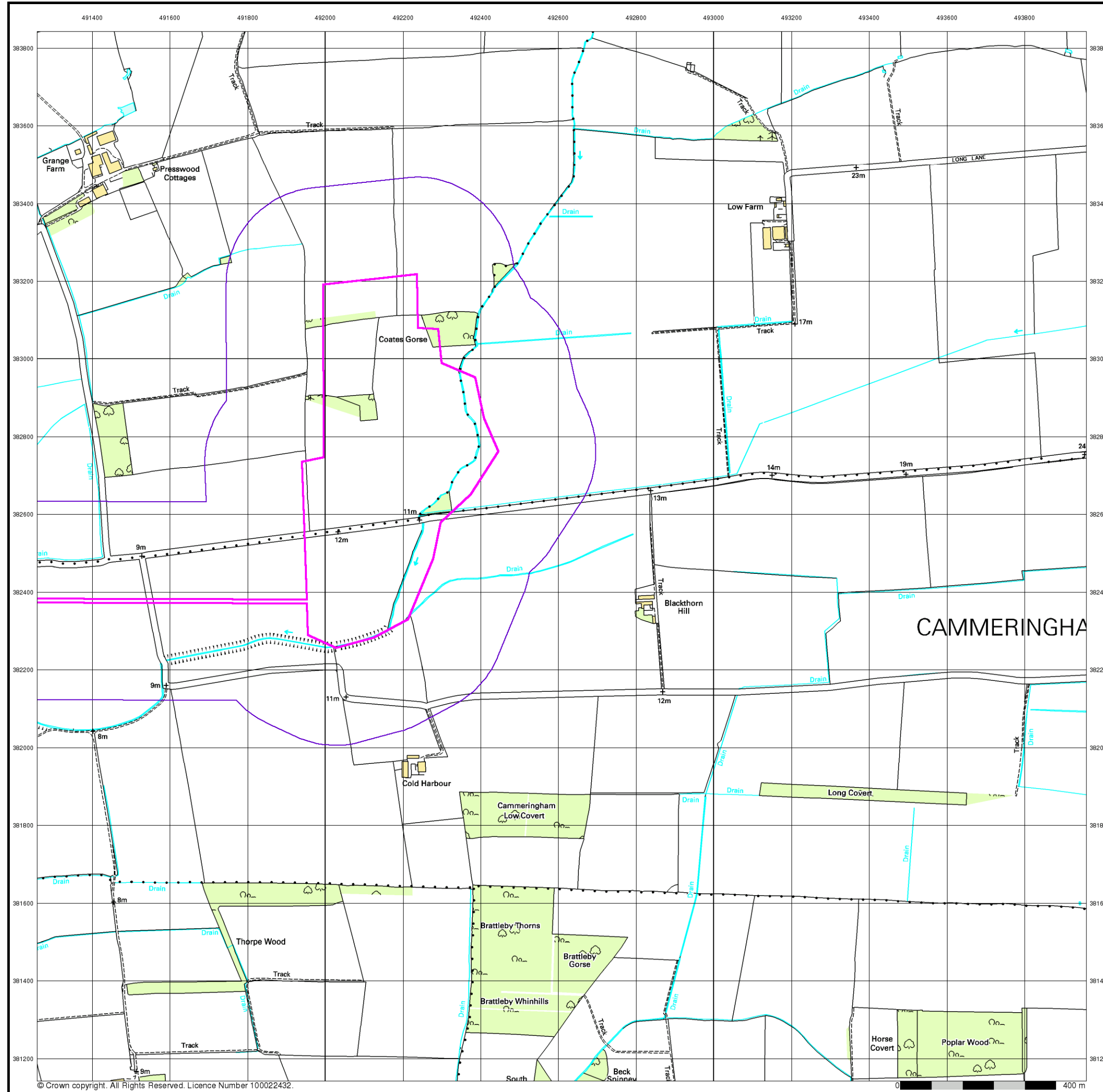

© Crown copyright. All Rights Reserved. Licence Number 100022432.



10k Raster Mapping
Published 2000
Source map scale - 1:10,000

The historical maps shown were produced from the Ordnance Survey's 1:10,000 colour raster mapping. These maps are derived from Landplan which replaced the old 1:10,000 maps originally published in 1970. The data is highly detailed showing buildings, fences and field boundaries as well as all roads, tracks and paths. Road names are also included together with the relevant road number and classification. Boundary information depiction includes county, unitary authority, district, civil parish and constituency.

Map Name(s) and Date(s)

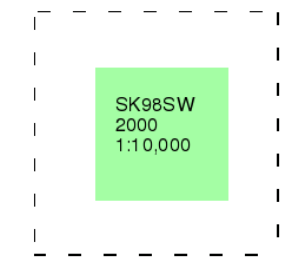

Historical Map - Slice B

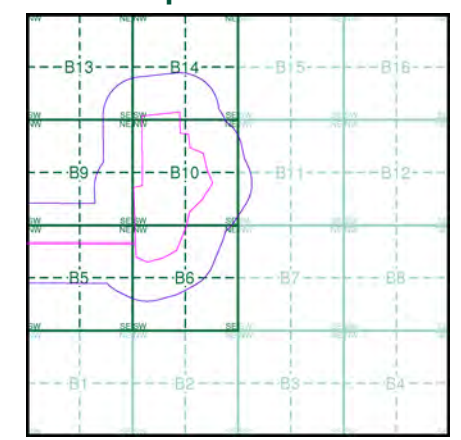

Order Details

Order Number: 297990273_1_1
 Customer Ref: 21-1088.04
 National Grid Reference: 492030, 382680
 Slice: B
 Site Area (Ha): 469.98
 Search Buffer (m): 250

Site Details

Cottam



Tel: [Redacted]
 Fax: [Redacted]
 Web: [Redacted]

Street View

Published 2022

Source map scale - 1:10,000

Street View is a street-level map for the whole of Great Britain produced by the Ordnance Survey. These maps are provided at a nominal scale of 1:10,000

Map Name(s) and Date(s)



Street View Map - Slice B

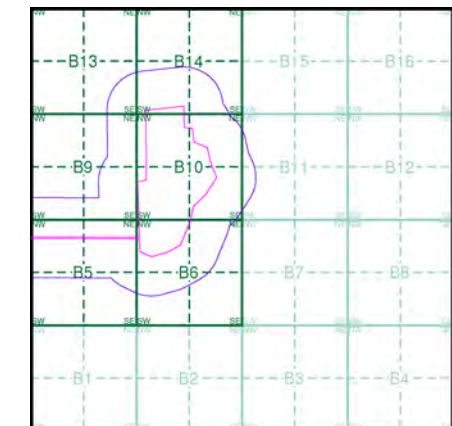

Order Details

Order Number: 297990273_1_1
 Customer Ref: 21-1088.04
 National Grid Reference: 492030, 382680
 Slice: B
 Site Area (Ha): 469.98
 Search Buffer (m): 250

Site Details

Cottam

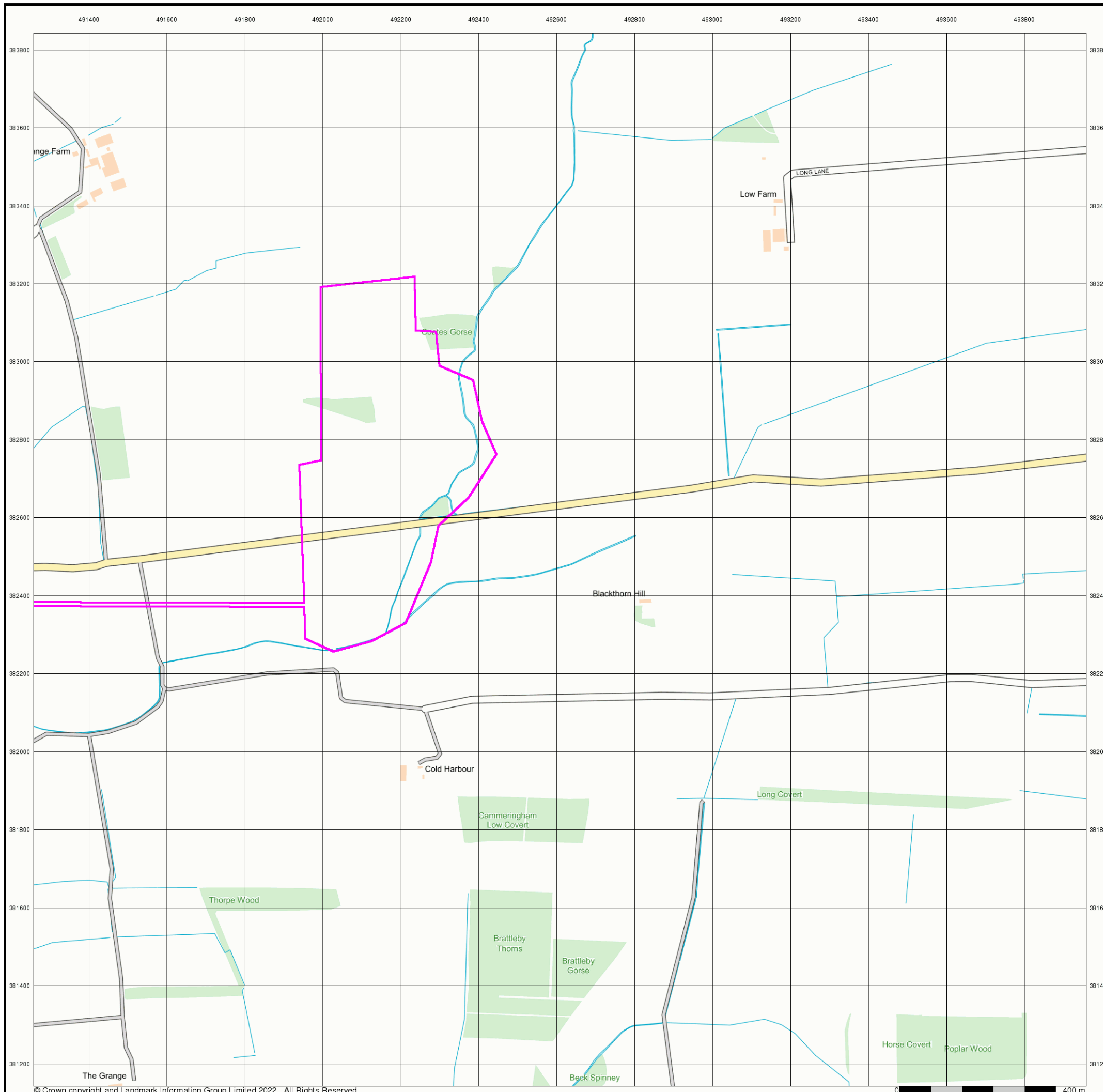

Historical Mapping Legends

Ordnance Survey County Series and Ordnance Survey Plan 1:2,500

Quarry **Gravel Pit** **Sand Pit**
Clay Pit **Shingle** **Refuse Heap**
Sloping Masonry **Flat Rock**
Marsh **Reeds** **Osiers**
Rough Pasture **Furze** **Wood**
Mixed Wood **Brushwood** **Orchard**
Fir **Ford** **Stepping Stones**
Ferry **Waterfall** **Lock**
Trig. Station **Altitude at Trig. Station**
B.M. 325.9 **Bench Mark** **Surface Level**
Arrow denotes flow of water **Antiquities (site of)**
Cutting **Embankment**
Railway crossing Road **Level Crossing** **Road crossing Railway**
Railway crossing River or Canal **Road over single stream** **Road over River or Canal**
County Boundary (Geographical)
County & Civil Parish Boundary
Administrative County & Civil Parish Boundary
County Borough Boundary (England)
Co. Boro. Bdy.
County Burgh Boundary (Scotland)
Co. Burgh Bdy.
BP BS Boundary Post or Stone **P.C.B** Police Call Box
B.R. Bridle Road **P** Pump
E.P Electricity Pylon **S.P** Signal Post
F.B. Foot Bridge **SL** Sluice
F.P. Foot Path **Sp.** Spring
G.P Guide Post or Board **T.C.B** Telephone Call Box
M.S Mile Stone **Tr.** Trough
M.P M.R Mooring Post or Ring **W** Well

Ordnance Survey Plan, Additional SIMs and Supply of Unpublished Survey Information 1:2,500 and 1:1,250

Inactive Quarry, Chalk Pit or Clay Pit **Active Quarry, Chalk Pit or Clay Pit**
Rock **Boulders**
Cliff **Slopes** **Top**
Roofed Building **Glazed Roof Building**
Sloping Masonry **Archway**
Non-Coniferous Tree (surveyed) **Coniferous Tree (surveyed)**
Non-Coniferous Trees (not surveyed) **Coniferous Trees (not surveyed)**
Orchard Tree **Scrub** **Bracken**
Coppice, Osier **Reeds** **Marsh, Saltings**
Rough Grassland **Heath** **Culvert**
Direction of water flow **Bench Mark** **Antiquity (site of)**
Cave Entrance **Triangulation Station** **Electricity Pylon**
Electricity Transmission Line
County Boundary (Geographical)
County & Civil Parish Boundary
Civil Parish Boundary
Admin. County or County Bor. Boundary
London Borough Boundary
Symbol marking point where boundary mereing changes
BH Beer House **P** Pillar, Pole or Post
BP, BS Boundary Post or Stone **PO** Post Office
Cn, C Capstan, Crane **PC** Public Convenience
Chy Chimney **PH** Public House
D Fn Drinking Fountain **Pp** Pump
EI P Electricity Pillar or Post **SB, S Br** Signal Box or Bridge
FAP Fire Alarm Pillar **SP, SL** Signal Post or Light
FB Foot Bridge **Spr** Spring
GP Guide Post **Tk** Tank or Track
H Hydrant or Hydraulic **TCB** Telephone Call Box
LC Level Crossing **TCP** Telephone Call Post
MH Manhole **Tr** Trough
MP Mile Post or Mooring Post **Wr Pt, Wr T** Water Point, Water Tap
MS Mile Stone **W** Well
NTL Normal Tidal Limit **Wd Pp** Wind Pump

Large-Scale National Grid Data 1:2,500 and 1:1,250

Cliff **Slopes** **Top**
Rock **Rock (scattered)**
Boulders **Boulders (scattered)**
Positioned Boulder **Scree**
Non-Coniferous Tree (surveyed) **Coniferous Tree (surveyed)**
Non-Coniferous Trees (not surveyed) **Coniferous Trees (not surveyed)**
Orchard Tree **Scrub** **Bracken**
Coppice, Osier **Reeds** **Marsh, Saltings**
Rough Grassland **Heath** **Culvert**
Direction of water flow **Triangulation Station** **Antiquity (site of)**
Electricity Transmission Line **Electricity Pylon**
B.M. 231.60m Bench Mark **Buildings with Building Seed**
Roofed Building **Glazed Roof Building**
Civil parish/community boundary
District boundary
County boundary
Boundary post/stone
Boundary mereing symbol (note: these always appear in opposed pairs or groups of three)
Bks Barracks **P** Pillar, Pole or Post
Bty Battery **PO** Post Office
Cemy Cemetery **PC** Public Convenience
Chy Chimney **Pp** Pump
Cis Cistern **Ppg Sta** Pumping Station
Dismtd Rly Dismantled Railway **PW** Place of Worship
EI Gen Sta Electricity Generating Station **Sewage Ppg Sta** Sewage Pumping Station
EI P Electricity Pole, Pillar **SB, S Br** Signal Box or Bridge
EI Sub Sta Electricity Sub Station **SP, SL** Signal Post or Light
FB Filter Bed **Spr** Spring
Fn / D Fn Fountain / Drinking Ftn. **Tk** Tank or Track
Gas Gov Gas Valve Compound **Tr** Trough
GVC Gas Governor **Wd Pp** Wind Pump
GP Guide Post **Wr Pt, Wr T** Water Point, Water Tap
MH Manhole **Wks** Works (building or area)
MP, MS Mile Post or Mile Stone **W** Well



Historical Mapping & Photography included:

Mapping Type	Scale	Date	Pg
Lincolnshire	1:2,500	1886	2
Lincolnshire	1:2,500	1906	3
Ordnance Survey Plan	1:2,500	1973 - 1974	4
Large-Scale National Grid Data	1:2,500	1994	5

Historical Map - Segment B5

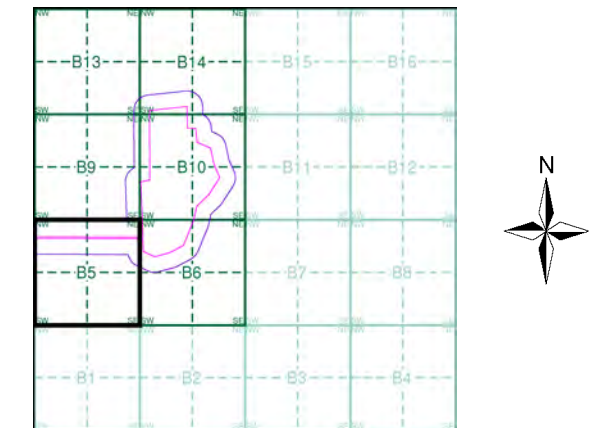

Order Details

Order Number: 297990273_1_1
 Customer Ref: 21-1088.04
 National Grid Reference: 492030, 382680
 Slice: B
 Site Area (Ha): 469.98
 Search Buffer (m): 100

Site Details

Cottam



Tel: [Redacted]
 Fax: [Redacted]
 Web: [Redacted]

Lincolnshire
Published 1886

Source map scale - 1:2,500

The historical maps shown were reproduced from maps predominantly held at the scale adopted for England, Wales and Scotland in the 1840's. In 1854 the 1:2,500 scale was adopted for mapping urban areas and by 1896 it covered the whole of what were considered to be the cultivated parts of Great Britain. The published date given below is often some years later than the surveyed date. Before 1938, all OS maps were based on the Cassini Projection, with independent surveys of a single county or group of counties, giving rise to significant inaccuracies in outlying areas.

Map Name(s) and Date(s)

051_12	1886	1:2,500
051_16	1886	1:2,500

Historical Map - Segment B5

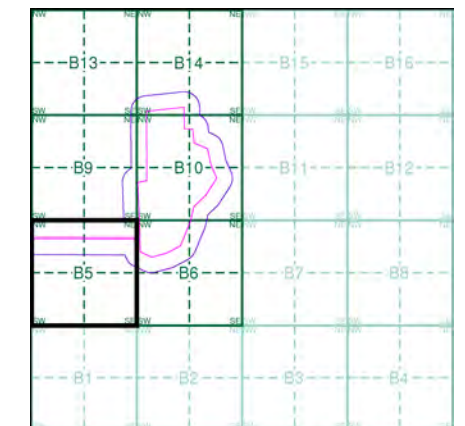

Order Details

Order Number: 297990273_1_1
 Customer Ref: 21-1088.04
 National Grid Reference: 492030, 382680
 Slice: B
 Site Area (Ha): 469.98
 Search Buffer (m): 100

Site Details

Cottam

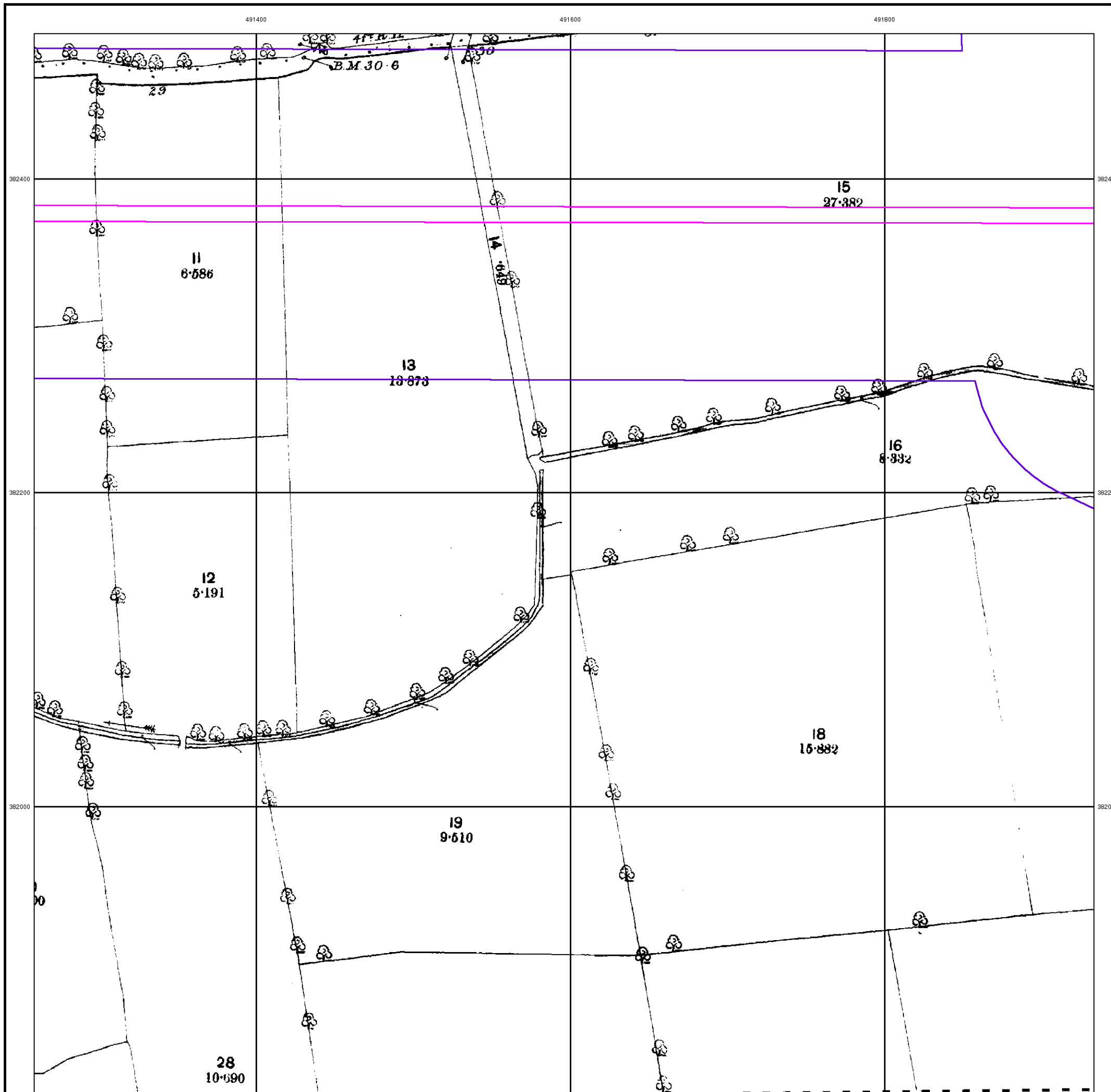

Lincolnshire
Published 1906

Source map scale - 1:2,500

The historical maps shown were reproduced from maps predominantly held at the scale adopted for England, Wales and Scotland in the 1840's. In 1854 the 1:2,500 scale was adopted for mapping urban areas and by 1896 it covered the whole of what were considered to be the cultivated parts of Great Britain. The published date given below is often some years later than the surveyed date. Before 1938, all OS maps were based on the Cassini Projection, with independent surveys of a single county or group of counties, giving rise to significant inaccuracies in outlying areas.

Map Name(s) and Date(s)

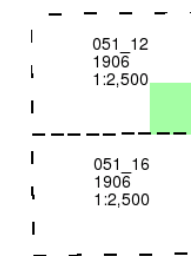

Historical Map - Segment B5

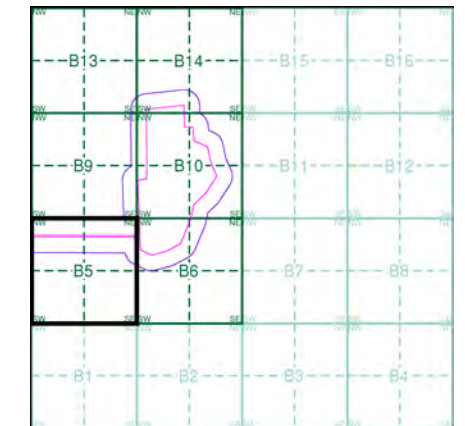

Order Details

Order Number: 297990273_1_1
 Customer Ref: 21-1088.04
 National Grid Reference: 492030, 382680
 Slice: B
 Site Area (Ha): 469.98
 Search Buffer (m): 100

Site Details

Cottam

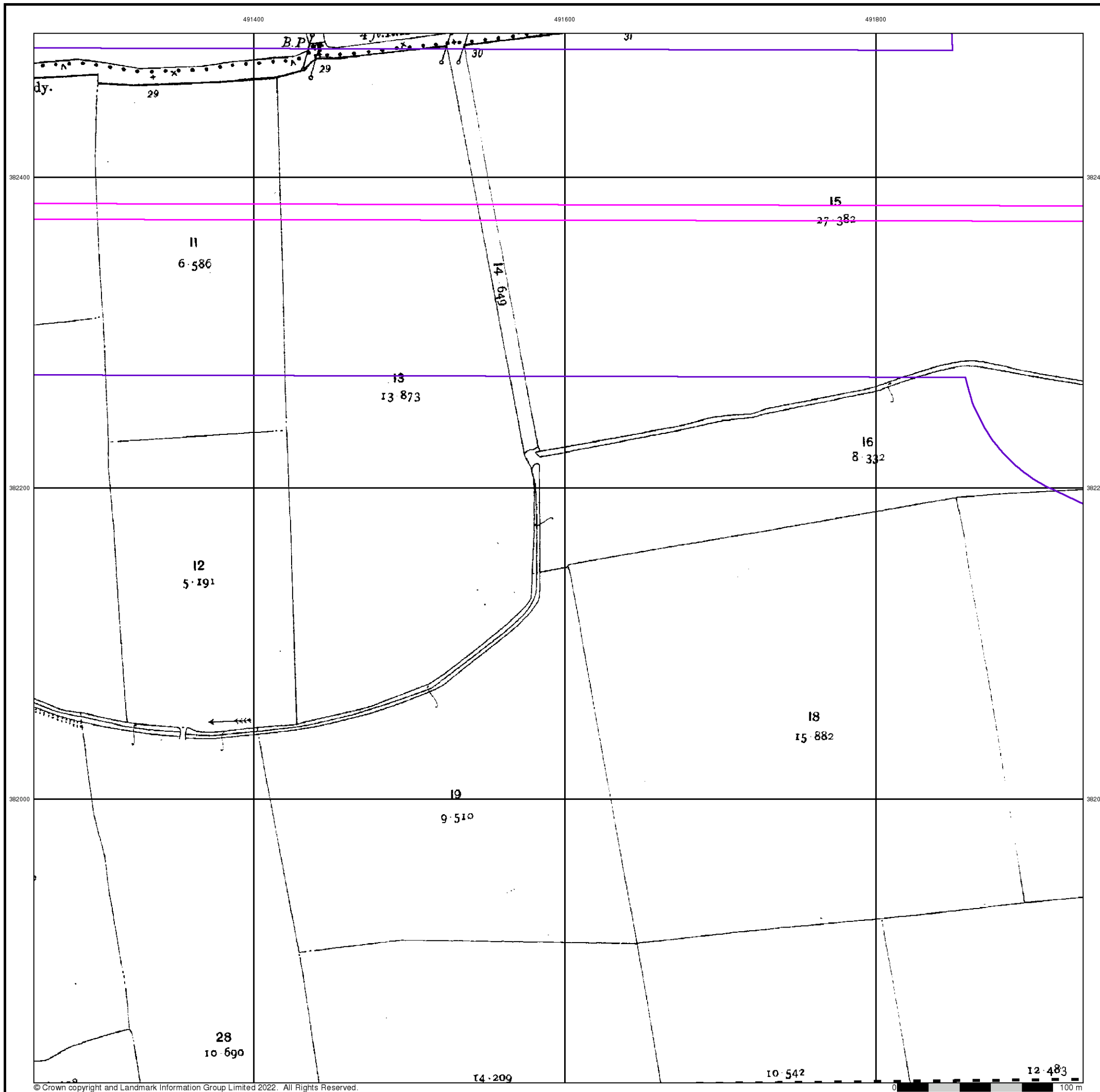

Ordnance Survey Plan

Published 1973 - 1974

Source map scale - 1:2,500

The historical maps shown were reproduced from maps predominantly held at the scale adopted for England, Wales and Scotland in the 1840's. In 1854 the 1:2,500 scale was adopted for mapping urban areas and by 1896 it covered the whole of what were considered to be the cultivated parts of Great Britain. The published date given below is often some years later than the surveyed date. Before 1938, all OS maps were based on the Cassini Projection, with independent surveys of a single county or group of counties, giving rise to significant inaccuracies in outlying areas.

Map Name(s) and Date(s)

SK9182	1974	1:2,500
SK9181	1973	1:2,500

Historical Map - Segment B5

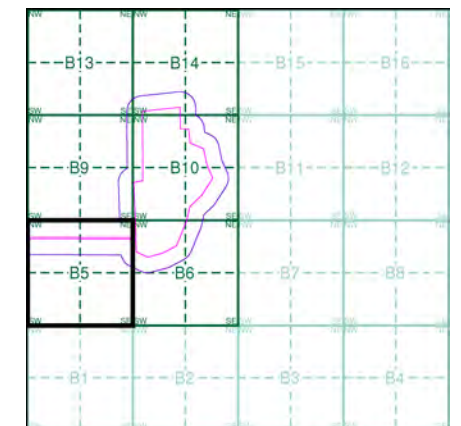

Order Details

Order Number: 297990273_1_1
 Customer Ref: 21-1088.04
 National Grid Reference: 492030, 382680
 Slice: B
 Site Area (Ha): 469.98
 Search Buffer (m): 100

Site Details

Cottam

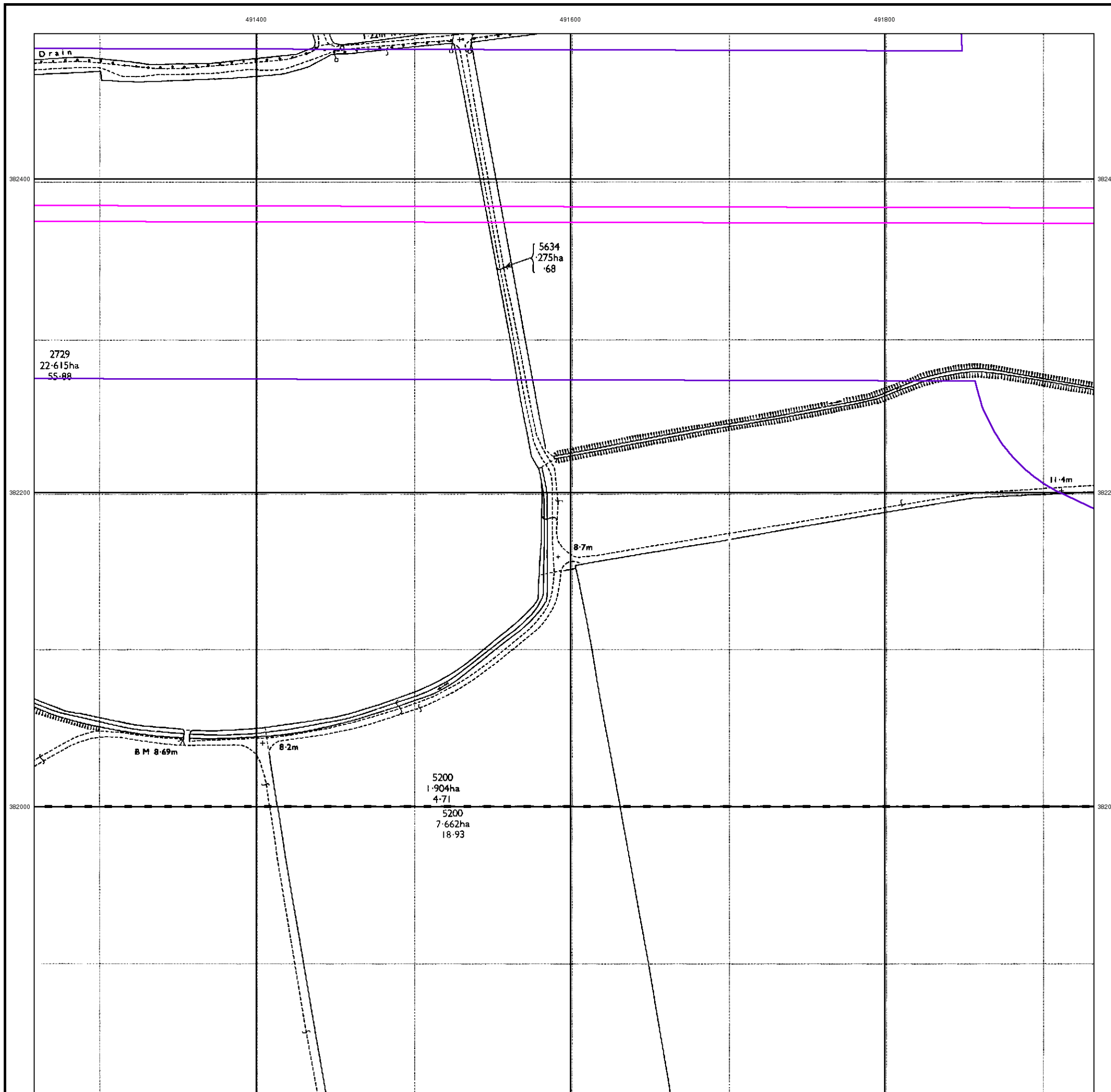

Large-Scale National Grid Data

Published 1994

Source map scale - 1:2,500

'Large Scale National Grid Data' superseded SIM cards (Ordnance Survey's 'Survey of Information on Microfilm') in 1992, and continued to be produced until 1999. These maps were the fore-runners of digital mapping and so provide detailed information on houses and roads, but tend to show less topographic features such as vegetation. These maps were produced at both 1:2,500 and 1:1,250 scales.

Map Name(s) and Date(s)

SK9182	1994	1:2,500
SK9181	1994	1:2,500

Historical Map - Segment B5

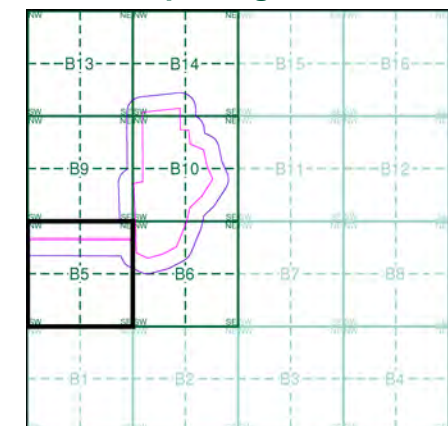

Order Details

Order Number: 297990273_1_1
 Customer Ref: 21-1088.04
 National Grid Reference: 492030, 382680
 Slice: B
 Site Area (Ha): 469.98
 Search Buffer (m): 100

Site Details

Cottam

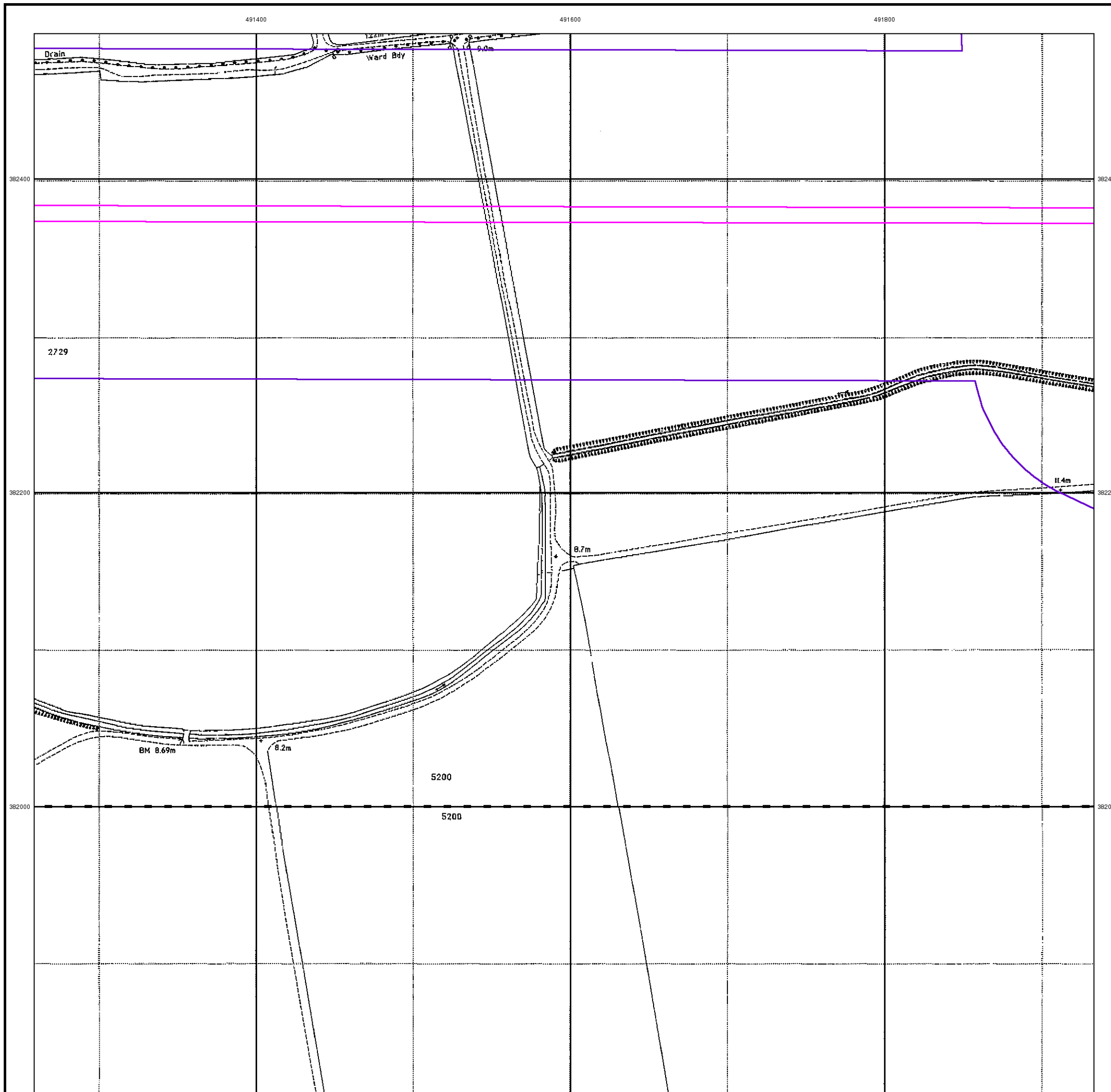

Historical Mapping Legends

Ordnance Survey County Series and Ordnance Survey Plan 1:2,500

Quarry **Gravel Pit** **Sand Pit**
Clay Pit **Shingle** **Refuse Heap**
Sloping Masonry **Flat Rock**
Marsh **Reeds** **Osiers**
Rough Pasture **Furze** **Wood**
Mixed Wood **Brushwood** **Orchard**
Fir **Ford** **Stepping Stones**
Ferry **Waterfall** **Lock**
Trig. Station **Altitude at Trig. Station**
B.M. 325.9 **Bench Mark** **Surface Level**
Arrow denotes flow of water **Antiquities (site of)**
Cutting **Embankment**
Railway crossing Road **Level Crossing** **Road crossing Railway**
Railway crossing River or Canal **Road over single stream** **Road over River or Canal**
County Boundary (Geographical)
County & Civil Parish Boundary
Administrative County & Civil Parish Boundary
County Borough Boundary (England)
Co. Boro. Bdy.
County Burgh Boundary (Scotland)
Co. Burgh Bdy.
BP BS Boundary Post or Stone **P.C.B** Police Call Box
B.R. Bridle Road **P** Pump
E.P Electricity Pylon **S.P** Signal Post
F.B. Foot Bridge **SL** Sluice
F.P. Foot Path **Sp.** Spring
G.P Guide Post or Board **T.C.B** Telephone Call Box
M.S Mile Stone **Tr.** Trough
M.P M.R Mooring Post or Ring **W** Well

Ordnance Survey Plan, Additional SIMs and Supply of Unpublished Survey Information 1:2,500 and 1:1,250

Inactive Quarry, Chalk Pit or Clay Pit **Active Quarry, Chalk Pit or Clay Pit**
Rock **Boulders**
Cliff **Slopes** **Top**
Roofed Building **Glazed Roof Building**
Sloping Masonry **Archway**
Non-Coniferous Tree (surveyed) **Coniferous Tree (surveyed)**
Non-Coniferous Trees (not surveyed) **Coniferous Trees (not surveyed)**
Orchard Tree **Scrub** **Bracken**
Coppice, Osier **Reeds** **Marsh, Saltings**
Rough Grassland **Heath** **Culvert**
Direction of water flow **Bench Mark** **Antiquity (site of)**
Cave Entrance **Triangulation Station** **Electricity Pylon**
Electricity Transmission Line
County Boundary (Geographical)
County & Civil Parish Boundary
Civil Parish Boundary
Admin. County or County Bor. Boundary
London Borough Boundary
Symbol marking point where boundary mereing changes
BH Beer House **P** Pillar, Pole or Post
BP, BS Boundary Post or Stone **PO** Post Office
Cn, C Capstan, Crane **PC** Public Convenience
Chy Chimney **PH** Public House
D Fn Drinking Fountain **Pp** Pump
EI P Electricity Pillar or Post **SB, S Br** Signal Box or Bridge
FAP Fire Alarm Pillar **SP, SL** Signal Post or Light
FB Foot Bridge **Spr** Spring
GP Guide Post **Tk** Tank or Track
H Hydrant or Hydraulic **TCB** Telephone Call Box
LC Level Crossing **TCP** Telephone Call Post
MH Manhole **Tr** Trough
MP Mile Post or Mooring Post **Wr Pt, Wr T** Water Point, Water Tap
MS Mile Stone **W** Well
NTL Normal Tidal Limit **Wd Pp** Wind Pump

Large-Scale National Grid Data 1:2,500 and 1:1,250

Cliff **Slopes** **Top**
Rock **Rock (scattered)**
Boulders **Boulders (scattered)**
Positioned Boulder **Scree**
Non-Coniferous Tree (surveyed) **Coniferous Tree (surveyed)**
Non-Coniferous Trees (not surveyed) **Coniferous Trees (not surveyed)**
Orchard Tree **Scrub** **Bracken**
Coppice, Osier **Reeds** **Marsh, Saltings**
Rough Grassland **Heath** **Culvert**
Direction of water flow **Triangulation Station** **Antiquity (site of)**
Electricity Transmission Line **Electricity Pylon**
B.M. 231.60m Bench Mark **Buildings with Building Seed**
Roofed Building **Glazed Roof Building**
Civil parish/community boundary
District boundary
County boundary
Boundary post/stone
Boundary mereing symbol (note: these always appear in opposed pairs or groups of three)
Bks Barracks **P** Pillar, Pole or Post
Bty Battery **PO** Post Office
Cemy Cemetery **PC** Public Convenience
Chy Chimney **Pp** Pump
Cis Cistern **Ppg Sta** Pumping Station
Dismtd Rly Dismantled Railway **PW** Place of Worship
EI Gen Sta Electricity Generating Station **Sewage Ppg Sta** Sewage Pumping Station
EI P Electricity Pole, Pillar **SB, S Br** Signal Box or Bridge
EI Sub Sta Electricity Sub Station **SP, SL** Signal Post or Light
FB Filter Bed **Spr** Spring
Fn / D Fn Fountain / Drinking Ftn. **Tk** Tank or Track
Gas Gov Gas Valve Compound **Tr** Trough
GVC Gas Governor **Wd Pp** Wind Pump
GP Guide Post **Wr Pt, Wr T** Water Point, Water Tap
MH Manhole **Wks** Works (building or area)
MP, MS Mile Post or Mile Stone **W** Well



Historical Mapping & Photography included:

Mapping Type	Scale	Date	Pg
Lincolnshire	1:2,500	1886	2
Lincolnshire	1:2,500	1906	3
Ordnance Survey Plan	1:2,500	1973 - 1974	4
Large-Scale National Grid Data	1:2,500	1994	5

Historical Map - Segment B6

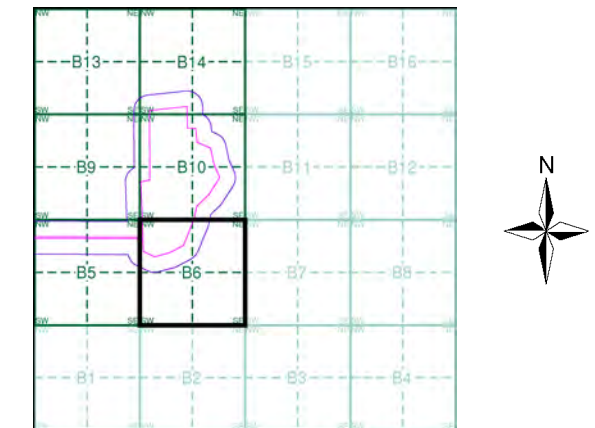

Order Details

Order Number: 297990273_1_1
 Customer Ref: 21-1088.04
 National Grid Reference: 492030, 382680
 Slice: B
 Site Area (Ha): 469.98
 Search Buffer (m): 100

Site Details

Cottam



Tel:
Fax:
Web:

Lincolnshire
Published 1886

Source map scale - 1:2,500

The historical maps shown were reproduced from maps predominantly held at the scale adopted for England, Wales and Scotland in the 1840's. In 1854 the 1:2,500 scale was adopted for mapping urban areas and by 1896 it covered the whole of what were considered to be the cultivated parts of Great Britain. The published date given below is often some years later than the surveyed date. Before 1938, all OS maps were based on the Cassini Projection, with independent surveys of a single county or group of counties, giving rise to significant inaccuracies in outlying areas.

Map Name(s) and Date(s)

051_12 1886 1:2,500	052_09 1886 1:2,500
051_16 1886 1:2,500	052_13 1886 1:2,500

Historical Map - Segment B6

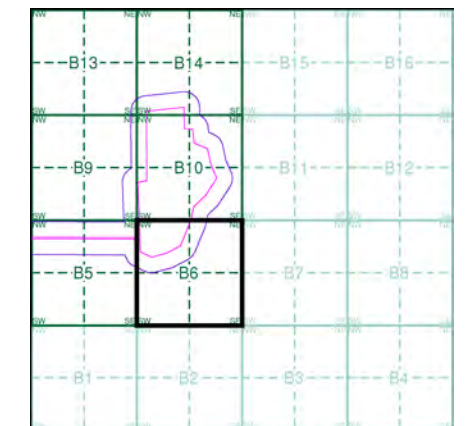

Order Details

Order Number: 297990273_1_1
Customer Ref: 21-1088.04
National Grid Reference: 492030, 382680
Slice: B
Site Area (Ha): 469.98
Search Buffer (m): 100

Site Details

Cottam

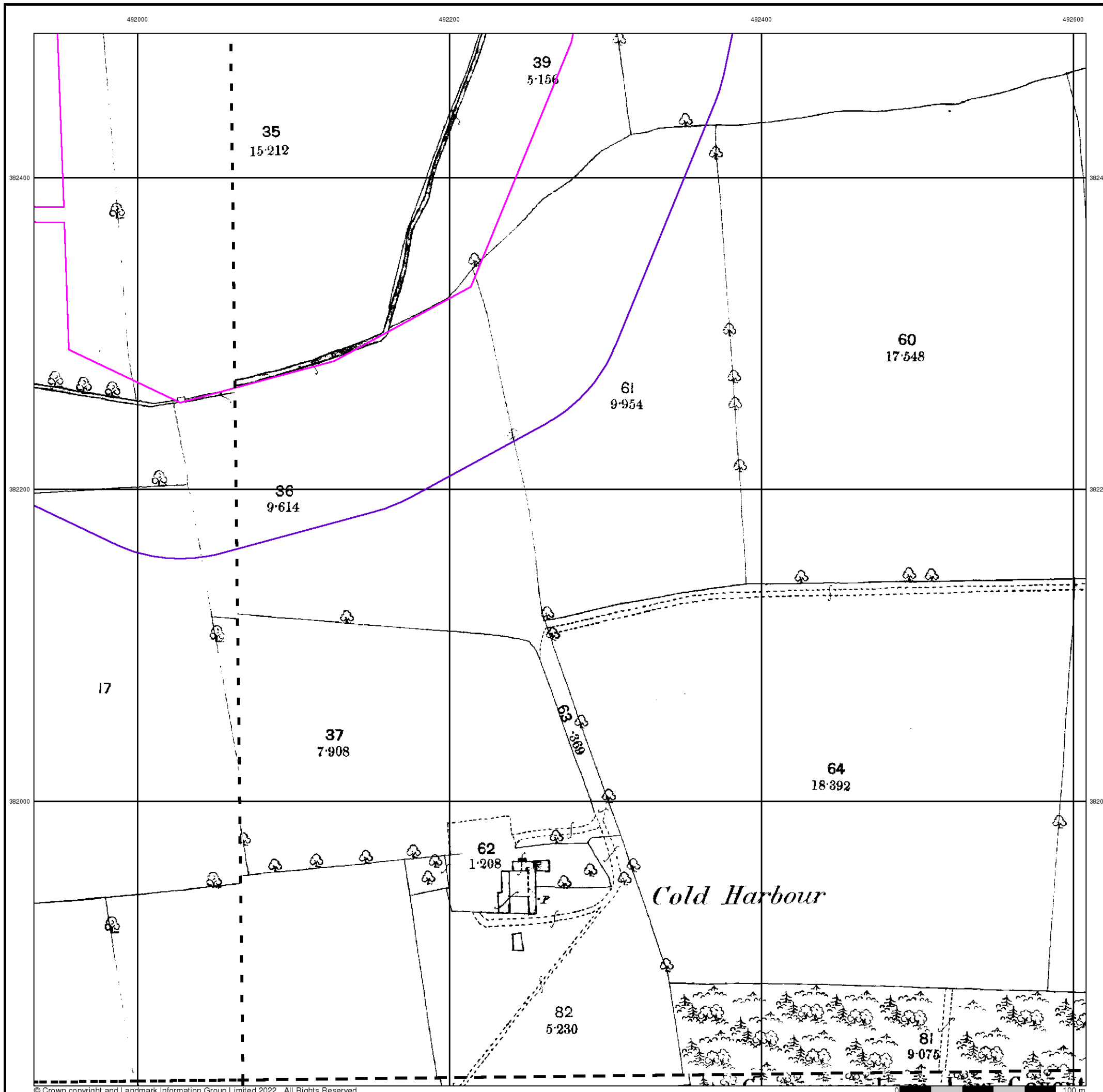

Lincolnshire
Published 1906

Source map scale - 1:2,500

The historical maps shown were reproduced from maps predominantly held at the scale adopted for England, Wales and Scotland in the 1840's. In 1854 the 1:2,500 scale was adopted for mapping urban areas and by 1896 it covered the whole of what were considered to be the cultivated parts of Great Britain. The published date given below is often some years later than the surveyed date. Before 1938, all OS maps were based on the Cassini Projection, with independent surveys of a single county or group of counties, giving rise to significant inaccuracies in outlying areas.

Map Name(s) and Date(s)

051_12 1906 1:2,500	052_09 1906 1:2,500
051_16 1906 1:2,500	052_13 1906 1:2,500

Historical Map - Segment B6

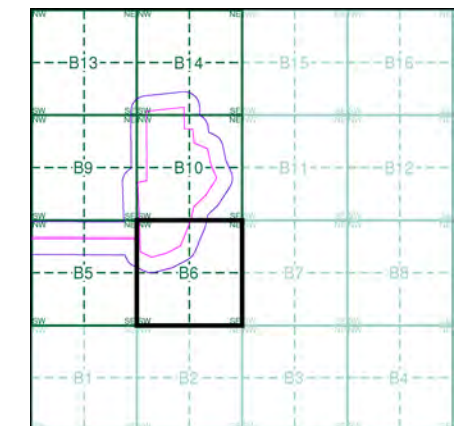

Order Details

Order Number: 297990273_1_1
Customer Ref: 21-1088.04
National Grid Reference: 492030, 382680
Slice: B
Site Area (Ha): 469.98
Search Buffer (m): 100

Site Details

Cottam

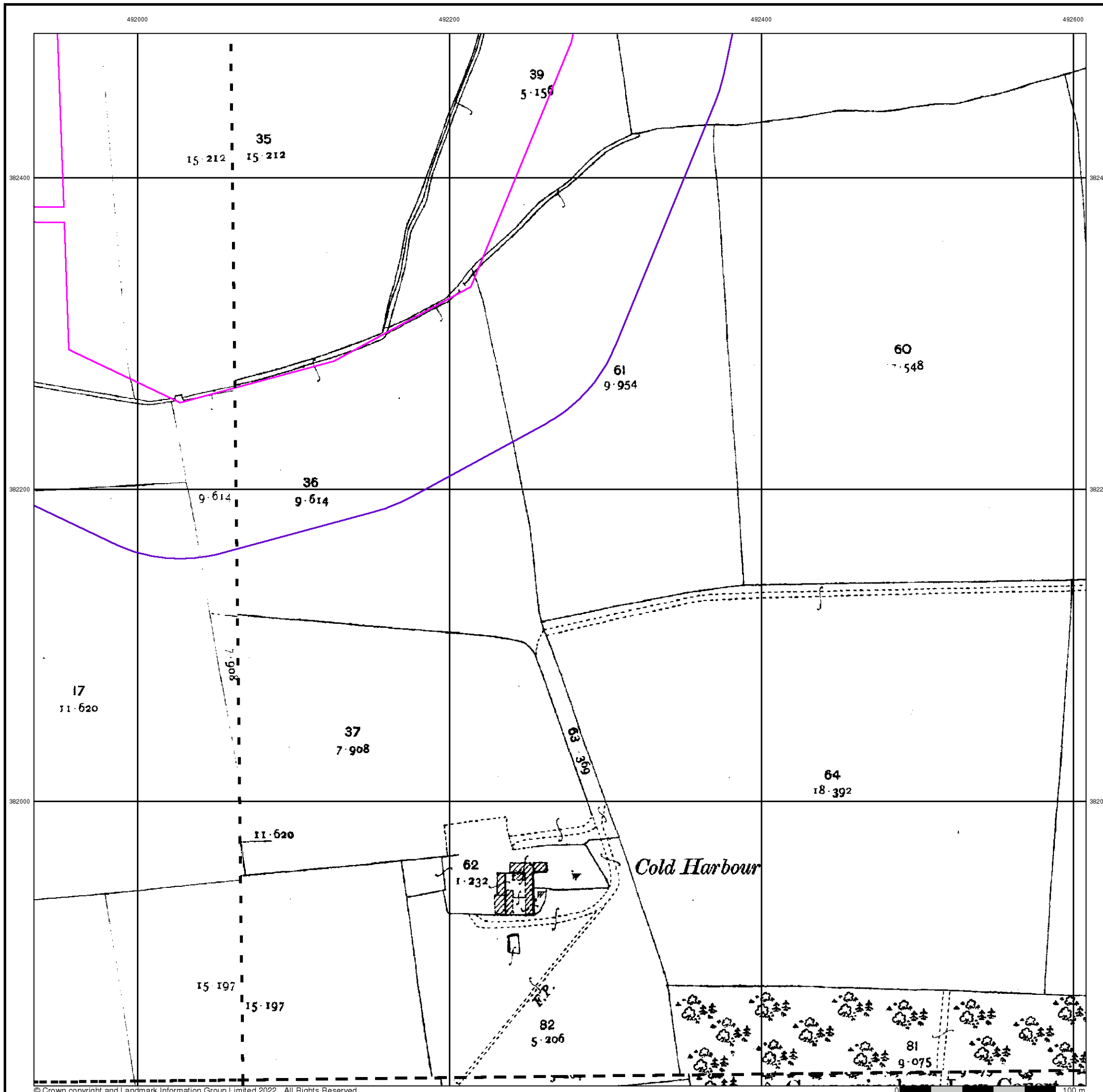

Ordnance Survey Plan

Published 1973 - 1974

Source map scale - 1:2,500

The historical maps shown were reproduced from maps predominantly held at the scale adopted for England, Wales and Scotland in the 1840's. In 1854 the 1:2,500 scale was adopted for mapping urban areas and by 1896 it covered the whole of what were considered to be the cultivated parts of Great Britain. The published date given below is often some years later than the surveyed date. Before 1938, all OS maps were based on the Cassini Projection, with independent surveys of a single county or group of counties, giving rise to significant inaccuracies in outlying areas.

Map Name(s) and Date(s)

SK9182 1974 1:2,500	SK9282 1974 1:2,500
SK9181 1973 1:2,500	SK9281 1974 1:2,500

Historical Map - Segment B6

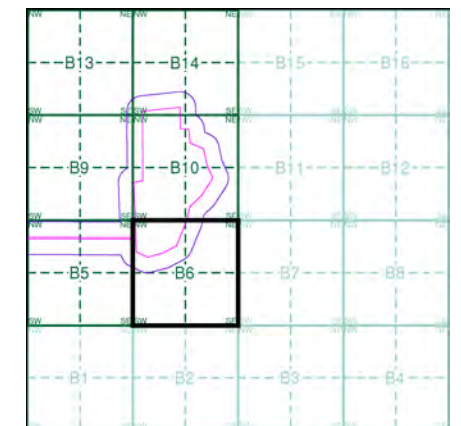

Order Details

Order Number: 297990273_1_1
 Customer Ref: 21-1088.04
 National Grid Reference: 492030, 382680
 Slice: B
 Site Area (Ha): 469.98
 Search Buffer (m): 100

Site Details

Cottam



Large-Scale National Grid Data

Published 1994

Source map scale - 1:2,500

'Large Scale National Grid Data' superseded SIM cards (Ordnance Survey's 'Survey of Information on Microfilm') in 1992, and continued to be produced until 1999. These maps were the fore-runners of digital mapping and so provide detailed information on houses and roads, but tend to show less topographic features such as vegetation. These maps were produced at both 1:2,500 and 1:1,250 scales.

Map Name(s) and Date(s)

SK9182 1994 1:2,500	SK9282 1994 1:2,500
SK9181 1994 1:2,500	SK9281 1994 1:2,500

Historical Map - Segment B6

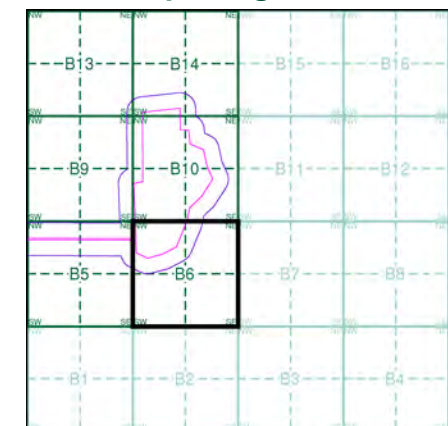

Order Details

Order Number: 297990273_1_1
 Customer Ref: 21-1088.04
 National Grid Reference: 492030, 382680
 Slice: B
 Site Area (Ha): 469.98
 Search Buffer (m): 100

Site Details

Cottam



Historical Mapping Legends

Ordnance Survey County Series and Ordnance Survey Plan 1:2,500

Quarry **Gravel Pit** **Sand Pit**
Clay Pit **Shingle** **Refuse Heap**
Sloping Masonry **Flat Rock**
Marsh **Reeds** **Osiers**
Rough Pasture **Furze** **Wood**
Mixed Wood **Brushwood** **Orchard**
Fir **Ford** **Stepping Stones**
Ferry **Waterfall** **Lock**
Trig. Station **Altitude at Trig. Station**
B.M. 325.9 **Bench Mark** **Surface Level**
Arrow denotes flow of water **Antiquities (site of)**
Cutting **Embankment**
Railway crossing Road **Level Crossing** **Road crossing Railway**
Railway crossing River or Canal **Road over single stream** **Road over River or Canal**
County Boundary (Geographical)
County & Civil Parish Boundary
Administrative County & Civil Parish Boundary
County Borough Boundary (England)
Co. Boro. Bdy.
County Burgh Boundary (Scotland)
Co. Burgh Bdy.
BP BS Boundary Post or Stone **P.C.B** Police Call Box
B.R. Bridle Road **P** Pump
E.P Electricity Pylon **S.P** Signal Post
F.B. Foot Bridge **SL** Sluice
F.P. Foot Path **Sp.** Spring
G.P Guide Post or Board **T.C.B** Telephone Call Box
M.S Mile Stone **Tr.** Trough
M.P M.R Mooring Post or Ring **W** Well

Ordnance Survey Plan, Additional SIMs and Supply of Unpublished Survey Information 1:2,500 and 1:1,250

Inactive Quarry, Chalk Pit or Clay Pit **Active Quarry, Chalk Pit or Clay Pit**
Rock **Boulders**
Cliff **Slopes** **Top**
Roofed Building **Glazed Roof Building**
Sloping Masonry **Archway**
Non-Coniferous Tree (surveyed) **Coniferous Tree (surveyed)**
Non-Coniferous Trees (not surveyed) **Coniferous Trees (not surveyed)**
Orchard Tree **Scrub** **Bracken**
Coppice, Osier **Reeds** **Marsh, Saltings**
Rough Grassland **Heath** **Culvert**
Direction of water flow **Bench Mark** **Antiquity (site of)**
Cave Entrance **Triangulation Station** **Electricity Pylon**
Electricity Transmission Line
County Boundary (Geographical)
County & Civil Parish Boundary
Civil Parish Boundary
Admin. County or County Bor. Boundary
London Borough Boundary
Symbol marking point where boundary mereing changes
BH Beer House **P** Pillar, Pole or Post
BP, BS Boundary Post or Stone **PO** Post Office
Cn, C Capstan, Crane **PC** Public Convenience
Chy Chimney **PH** Public House
D Fn Drinking Fountain **Pp** Pump
EI P Electricity Pillar or Post **SB, S Br** Signal Box or Bridge
FAP Fire Alarm Pillar **SP, SL** Signal Post or Light
FB Foot Bridge **Spr** Spring
GP Guide Post **Tk** Tank or Track
H Hydrant or Hydraulic **TCB** Telephone Call Box
LC Level Crossing **TCP** Telephone Call Post
MH Manhole **Tr** Trough
MP Mile Post or Mooring Post **Wr Pt, Wr T** Water Point, Water Tap
MS Mile Stone **W** Well
NTL Normal Tidal Limit **Wd Pp** Wind Pump

Large-Scale National Grid Data 1:2,500 and 1:1,250

Cliff **Slopes** **Top**
Rock **Rock (scattered)**
Boulders **Boulders (scattered)**
Positioned Boulder **Scree**
Non-Coniferous Tree (surveyed) **Coniferous Tree (surveyed)**
Non-Coniferous Trees (not surveyed) **Coniferous Trees (not surveyed)**
Orchard Tree **Scrub** **Bracken**
Coppice, Osier **Reeds** **Marsh, Saltings**
Rough Grassland **Heath** **Culvert**
Direction of water flow **Triangulation Station** **Antiquity (site of)**
Electricity Transmission Line **Electricity Pylon**
Bench Mark **Buildings with Building Seed**
Roofed Building **Glazed Roof Building**
Civil parish/community boundary
District boundary
County boundary
Boundary post/stone
Boundary mereing symbol (note: these always appear in opposed pairs or groups of three)
Bks Barracks **P** Pillar, Pole or Post
Bty Battery **PO** Post Office
Cemy Cemetery **PC** Public Convenience
Chy Chimney **Pp** Pump
Cis Cistern **Ppg Sta** Pumping Station
Dismtd Rly Dismantled Railway **PW** Place of Worship
EI Gen Sta Electricity Generating Station **Sewage Ppg Sta** Sewage Pumping Station
EI P Electricity Pole, Pillar **SB, S Br** Signal Box or Bridge
EI Sub Sta Electricity Sub Station **SP, SL** Signal Post or Light
FB Filter Bed **Spr** Spring
Fn / D Fn Fountain / Drinking Ftn. **Tk** Tank or Track
Gas Gov Gas Valve Compound **Tr** Trough
GVC Gas Governor **Wd Pp** Wind Pump
GP Guide Post **Wr Pt, Wr T** Water Point, Water Tap
MH Manhole **Wks** Works (building or area)
MP, MS Mile Post or Mile Stone **W** Well



Historical Mapping & Photography included:

Mapping Type	Scale	Date	Pg
Lincolnshire	1:2,500	1886	2
Lincolnshire	1:2,500	1906	3
Ordnance Survey Plan	1:2,500	1974	4
Large-Scale National Grid Data	1:2,500	1994	5

Historical Map - Segment B9

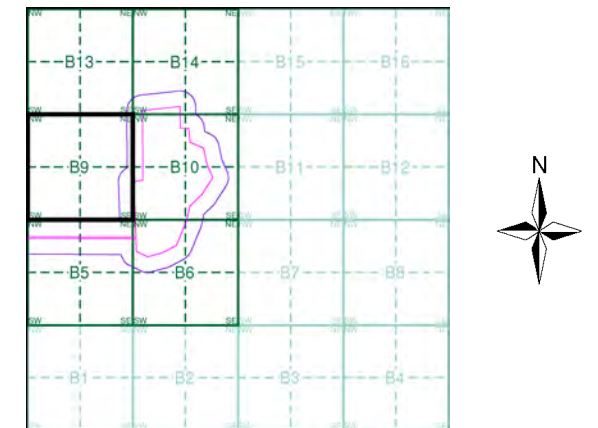

Order Details

Order Number: 297990273_1_1
 Customer Ref: 21-1088.04
 National Grid Reference: 492030, 382680
 Slice: B
 Site Area (Ha): 469.98
 Search Buffer (m): 100

Site Details

Cottam



Tel: [Redacted]
 Fax: [Redacted]
 Web: [Redacted]

Lincolnshire
Published 1886

Source map scale - 1:2,500

The historical maps shown were reproduced from maps predominantly held at the scale adopted for England, Wales and Scotland in the 1840's. In 1854 the 1:2,500 scale was adopted for mapping urban areas and by 1896 it covered the whole of what were considered to be the cultivated parts of Great Britain. The published date given below is often some years later than the surveyed date. Before 1938, all OS maps were based on the Cassini Projection, with independent surveys of a single county or group of counties, giving rise to significant inaccuracies in outlying areas.

Map Name(s) and Date(s)

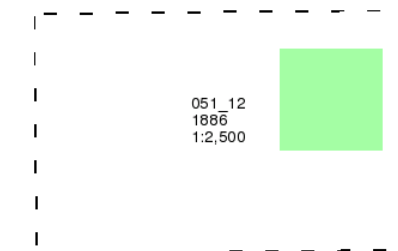

Historical Map - Segment B9

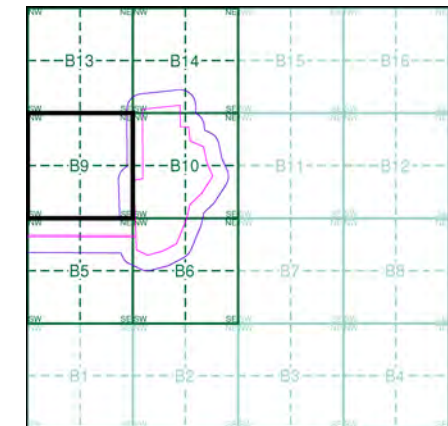

Order Details

Order Number: 297990273_1_1
 Customer Ref: 21-1088.04
 National Grid Reference: 492030, 382680
 Slice: B
 Site Area (Ha): 469.98
 Search Buffer (m): 100

Site Details

Cottam

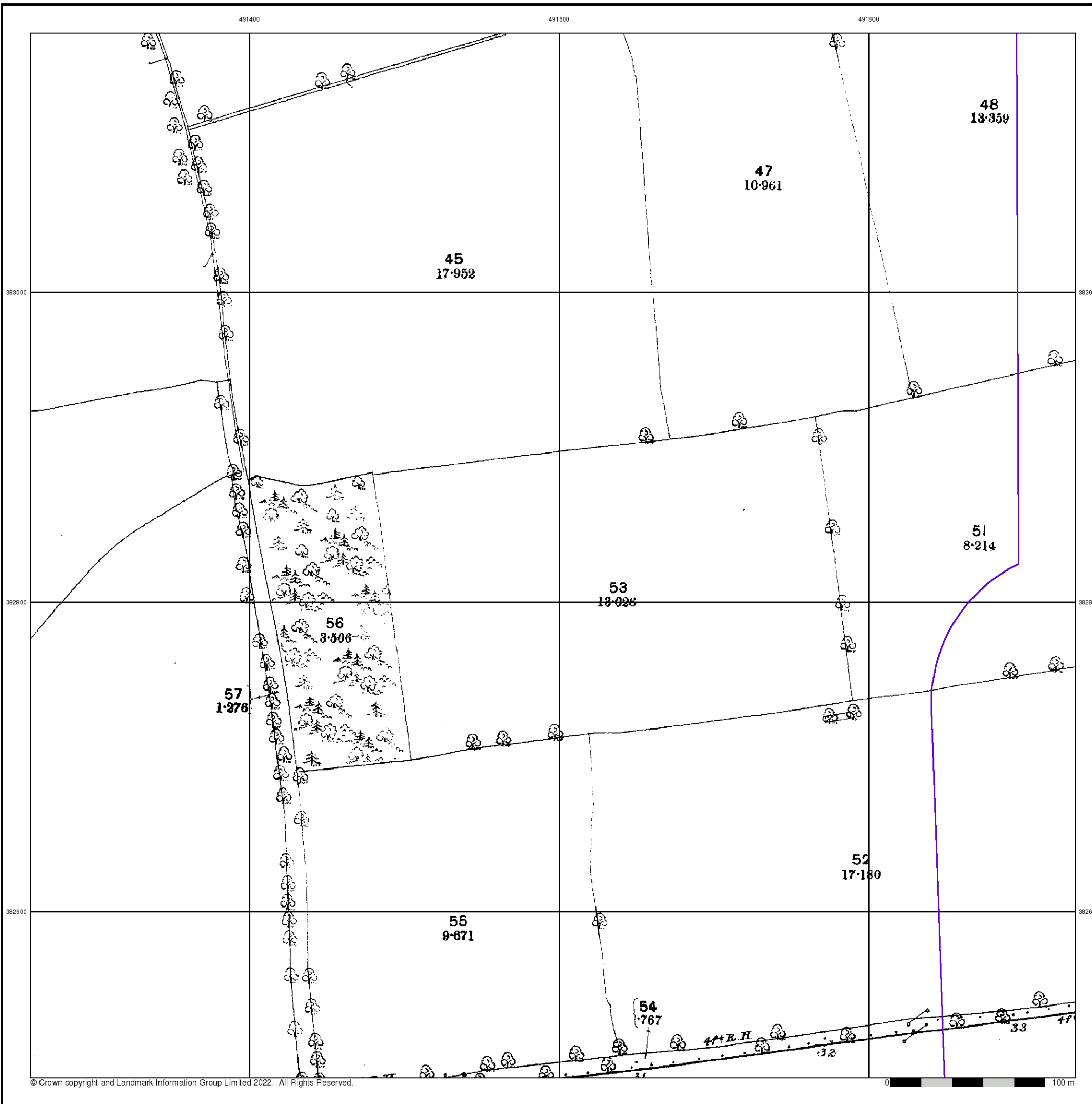

Lincolnshire
Published 1906

Source map scale - 1:2,500

The historical maps shown were reproduced from maps predominantly held at the scale adopted for England, Wales and Scotland in the 1840's. In 1854 the 1:2,500 scale was adopted for mapping urban areas and by 1896 it covered the whole of what were considered to be the cultivated parts of Great Britain. The published date given below is often some years later than the surveyed date. Before 1938, all OS maps were based on the Cassini Projection, with independent surveys of a single county or group of counties, giving rise to significant inaccuracies in outlying areas.

Map Name(s) and Date(s)

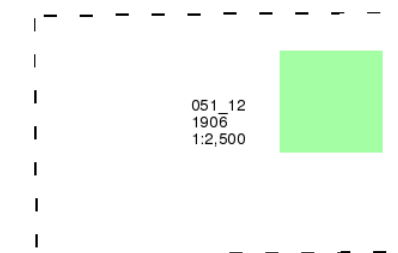

Historical Map - Segment B9

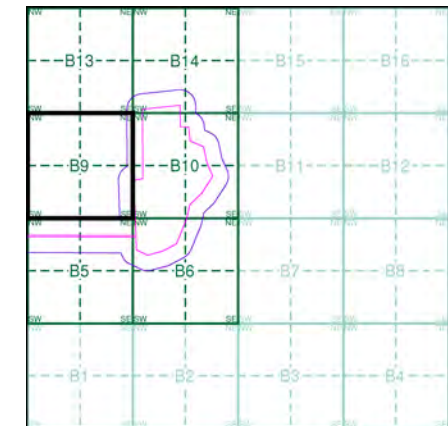

Order Details

Order Number: 297990273_1_1
 Customer Ref: 21-1088.04
 National Grid Reference: 492030, 382680
 Slice: B
 Site Area (Ha): 469.98
 Search Buffer (m): 100

Site Details

Cottam

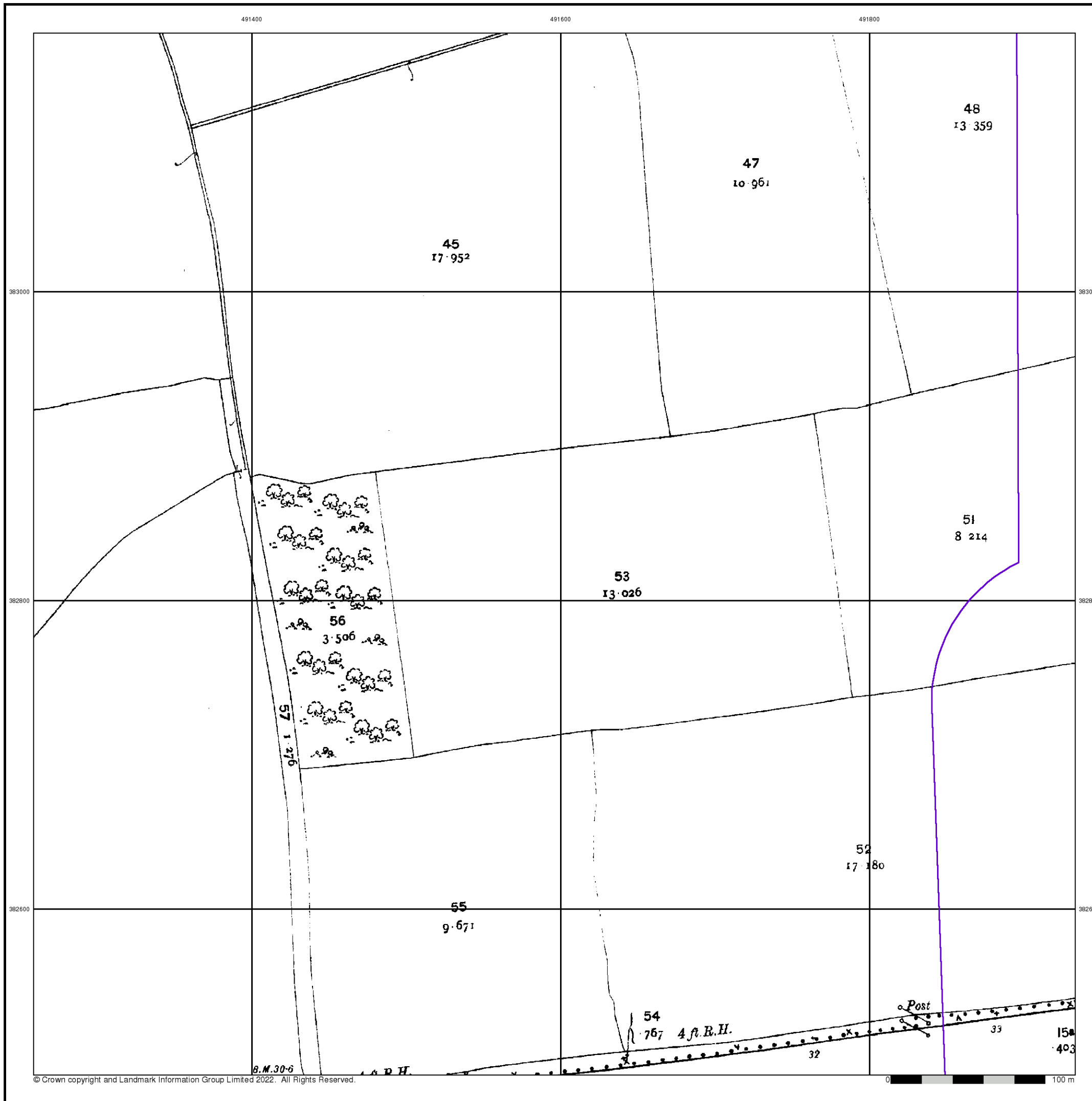

Ordnance Survey Plan

Published 1974

Source map scale - 1:2,500

The historical maps shown were reproduced from maps predominantly held at the scale adopted for England, Wales and Scotland in the 1840's. In 1854 the 1:2,500 scale was adopted for mapping urban areas and by 1896 it covered the whole of what were considered to be the cultivated parts of Great Britain. The published date given below is often some years later than the surveyed date. Before 1938, all OS maps were based on the Cassini Projection, with independent surveys of a single county or group of counties, giving rise to significant inaccuracies in outlying areas.

Map Name(s) and Date(s)

SK9183
1974
1:2,500
SK9182
1974
1:2,500

Historical Map - Segment B9

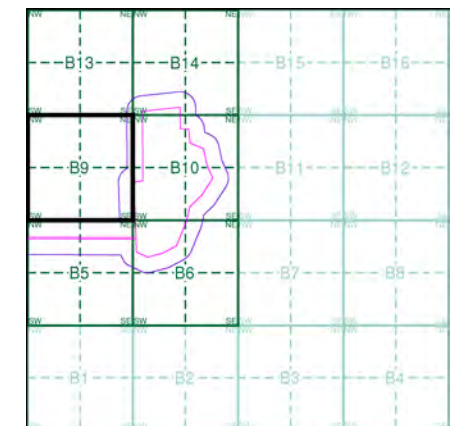

Order Details

Order Number: 297990273_1_1
 Customer Ref: 21-1088.04
 National Grid Reference: 492030, 382680
 Slice: B
 Site Area (Ha): 469.98
 Search Buffer (m): 100

Site Details

Cottam



Large-Scale National Grid Data

Published 1994

Source map scale - 1:2,500

'Large Scale National Grid Data' superseded SIM cards (Ordnance Survey's 'Survey of Information on Microfilm') in 1992, and continued to be produced until 1999. These maps were the fore-runners of digital mapping and so provide detailed information on houses and roads, but tend to show less topographic features such as vegetation. These maps were produced at both 1:2,500 and 1:1,250 scales.

Map Name(s) and Date(s)

SK9183	1994	1:2,500
SK9182	1994	1:2,500

Historical Map - Segment B9

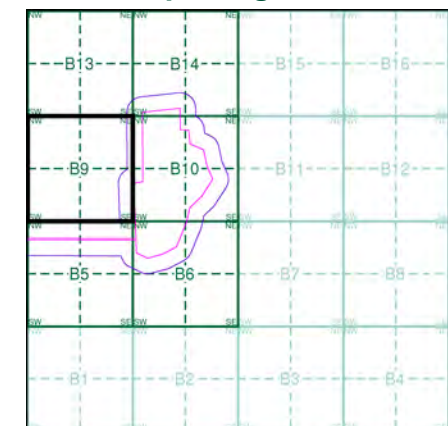

Order Details

Order Number: 297990273_1_1
 Customer Ref: 21-1088.04
 National Grid Reference: 492030, 382680
 Slice: B
 Site Area (Ha): 469.98
 Search Buffer (m): 100

Site Details

Cottam

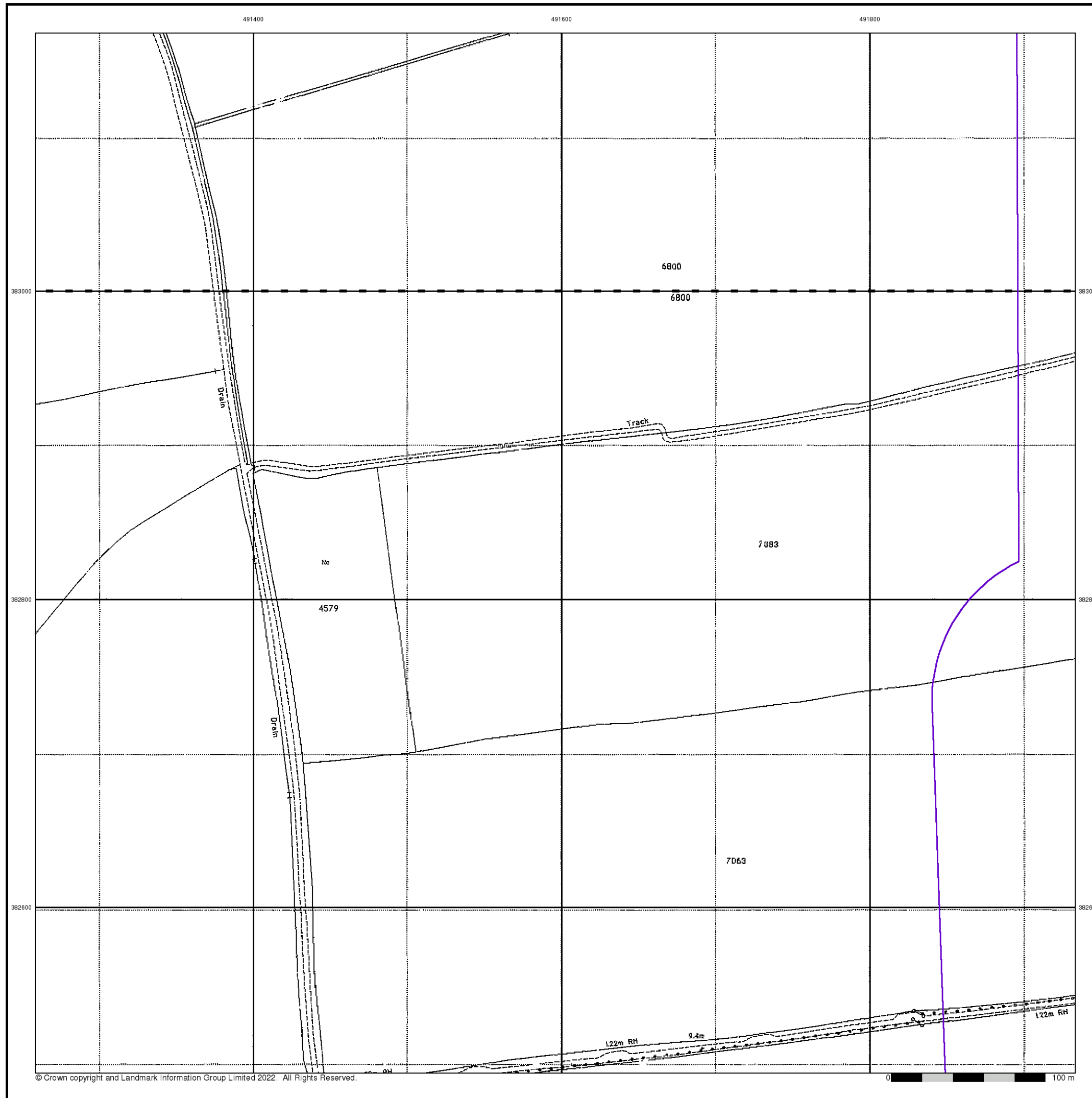

Historical Mapping Legends

Ordnance Survey County Series and Ordnance Survey Plan 1:2,500

Quarry **Gravel Pit** **Sand Pit**
Clay Pit **Shingle** **Refuse Heap**
Sloping Masonry **Flat Rock**
Marsh **Reeds** **Osiers**
Rough Pasture **Furze** **Wood**
Mixed Wood **Brushwood** **Orchard**
Fir **Ford** **Stepping Stones**
Ferry **Waterfall** **Lock**
Trig. Station **Altitude at Trig. Station**
B.M. 325.9 **Bench Mark** **Surface Level**
Arrow denotes flow of water **Antiquities (site of)**
Cutting **Embankment**
Railway crossing Road **Level Crossing** **Road crossing Railway**
Railway crossing River or Canal **Road over single stream** **Road over River or Canal**
County Boundary (Geographical)
County & Civil Parish Boundary
Administrative County & Civil Parish Boundary
County Borough Boundary (England)
Co. Boro. Bdy.
County Burgh Boundary (Scotland)
Boundary Post or Stone **Police Call Box**
B.R. **Bridle Road** **P** **Pump**
E.P **Electricity Pylon** **S.P** **Signal Post**
F.B. **Foot Bridge** **Sl** **Sluice**
F.P. **Foot Path** **Sp.** **Spring**
G.P **Guide Post or Board** **T.C.B** **Telephone Call Box**
M.S **Mile Stone** **Tr.** **Trough**
M.P M.R **Mooring Post or Ring** **W** **Well**

Ordnance Survey Plan, Additional SIMs and Supply of Unpublished Survey Information 1:2,500 and 1:1,250

Inactive Quarry, Chalk Pit or Clay Pit **Active Quarry, Chalk Pit or Clay Pit**
Rock **Boulders**
Cliff **Slopes** **Top**
Roofed Building **Glazed Roof Building**
Sloping Masonry **Archway**
Non-Coniferous Tree (surveyed) **Coniferous Tree (surveyed)**
Non-Coniferous Trees (not surveyed) **Coniferous Trees (not surveyed)**
Orchard Tree **Scrub** **Bracken**
Coppice, Osier **Reeds** **Marsh, Saltings**
Rough Grassland **Heath** **Culvert**
Direction of water flow **Bench Mark** **Antiquity (site of)**
Cave Entrance **Triangulation Station** **Electricity Pylon**
Electricity Transmission Line
County Boundary (Geographical)
County & Civil Parish Boundary
Civil Parish Boundary
Admin. County or County Bor. Boundary
London Borough Boundary
Symbol marking point where boundary mereing changes
Beer House **Pillar, Pole or Post**
Boundary Post or Stone **Post Office**
Capstan, Crane **Public Convenience**
Chimney **Public House**
Drinking Fountain **Pump**
Electricity Pillar or Post **Signal Box or Bridge**
Fire Alarm Pillar **Signal Post or Light**
Foot Bridge **Spring**
Guide Post **Tank or Track**
Hydrant or Hydraulic **Telephone Call Box**
Level Crossing **Telephone Call Post**
Manhole **Trough**
Mile Post or Mooring Post **Water Point, Water Tap**
Mile Stone **Well**
Normal Tidal Limit **Wind Pump**

Large-Scale National Grid Data 1:2,500 and 1:1,250

Cliff **Slopes** **Top**
Rock **Rock (scattered)**
Boulders **Boulders (scattered)**
Positioned Boulder **Scree**
Non-Coniferous Tree (surveyed) **Coniferous Tree (surveyed)**
Non-Coniferous Trees (not surveyed) **Coniferous Trees (not surveyed)**
Orchard Tree **Scrub** **Bracken**
Coppice, Osier **Reeds** **Marsh, Saltings**
Rough Grassland **Heath** **Culvert**
Direction of water flow **Triangulation Station** **Antiquity (site of)**
Electricity Transmission Line **Electricity Pylon**
Bench Mark **Buildings with Building Seed**
Roofed Building **Glazed Roof Building**
Civil parish/community boundary
District boundary
County boundary
Boundary post/stone
Boundary mereing symbol (note: these always appear in opposed pairs or groups of three)
Barracks **Pillar, Pole or Post**
Battery **Post Office**
Cemetery **Public Convenience**
Chimney **Pump**
Cistern **Pumping Station**
Dismtd Rly **Place of Worship**
Electricity Generating Station **Sewage Ppg Sta** **Sewage Pumping Station**
Electricity Pole, Pillar **Signal Box or Bridge**
Electricity Sub Station **Signal Post or Light**
Filter Bed **Spring**
Fountain / Drinking Ftn. **Tank or Track**
Gas Valve Compound **Trough**
Gas Governer **Wind Pump**
Guide Post **Water Point, Water Tap**
Manhole **Works (building or area)**
Mile Post or Mile Stone **Well**



Historical Mapping & Photography included:

Mapping Type	Scale	Date	Pg
Lincolnshire	1:2,500	1886	2
Lincolnshire	1:2,500	1906	3
Ordnance Survey Plan	1:2,500	1974	4
Large-Scale National Grid Data	1:2,500	1994	5

Historical Map - Segment B10

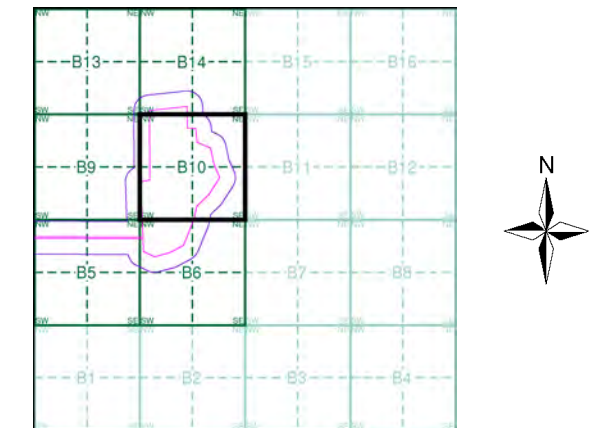

Order Details

Order Number: 297990273_1_1
 Customer Ref: 21-1088.04
 National Grid Reference: 492030, 382680
 Slice: B
 Site Area (Ha): 469.98
 Search Buffer (m): 100

Site Details

Cottam



Tel: [Redacted]
 Fax: [Redacted]
 Web: [Redacted]

Lincolnshire

Published 1886

Source map scale - 1:2,500

The historical maps shown were reproduced from maps predominantly held at the scale adopted for England, Wales and Scotland in the 1840's. In 1854 the 1:2,500 scale was adopted for mapping urban areas and by 1896 it covered the whole of what were considered to be the cultivated parts of Great Britain. The published date given below is often some years later than the surveyed date. Before 1938, all OS maps were based on the Cassini Projection, with independent surveys of a single county or group of counties, giving rise to significant inaccuracies in outlying areas.

Map Name(s) and Date(s)

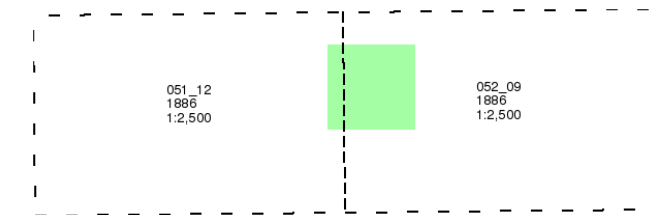

Historical Map - Segment B10

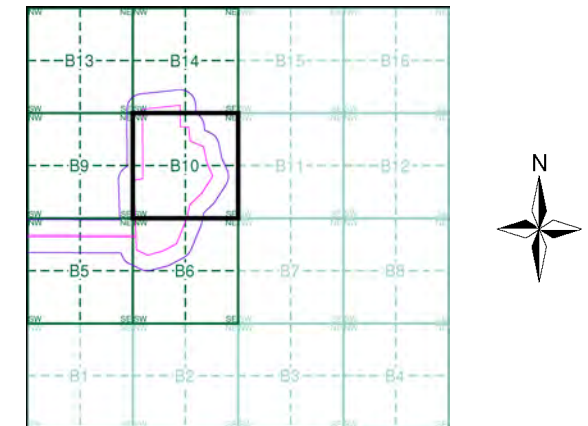

Order Details

Order Number: 297990273_1_1
 Customer Ref: 21-1088.04
 National Grid Reference: 492030, 382680
 Slice: B
 Site Area (Ha): 469.98
 Search Buffer (m): 100

Site Details

Cottam

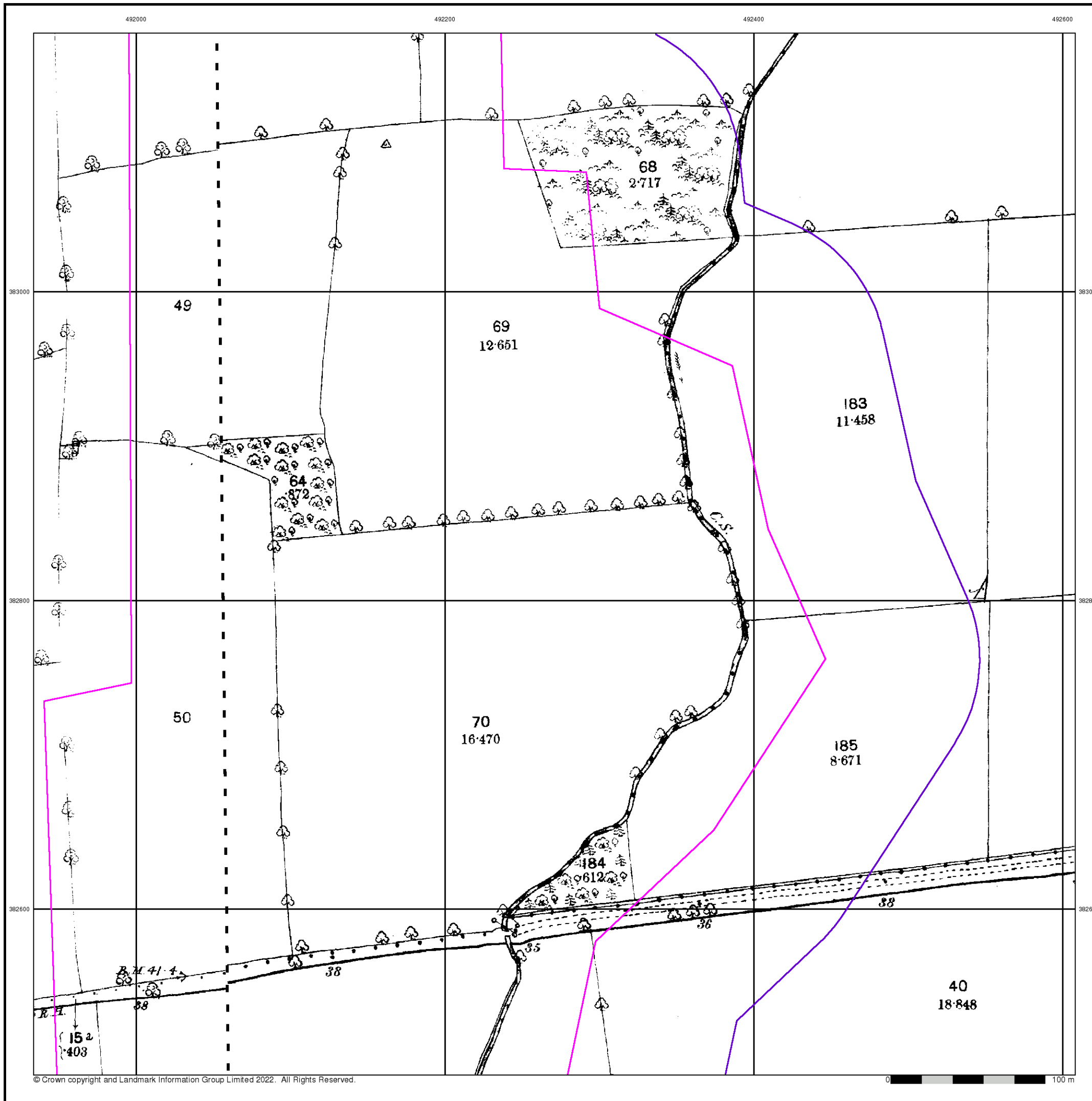

Lincolnshire

Published 1906

Source map scale - 1:2,500

The historical maps shown were reproduced from maps predominantly held at the scale adopted for England, Wales and Scotland in the 1840's. In 1854 the 1:2,500 scale was adopted for mapping urban areas and by 1896 it covered the whole of what were considered to be the cultivated parts of Great Britain. The published date given below is often some years later than the surveyed date. Before 1938, all OS maps were based on the Cassini Projection, with independent surveys of a single county or group of counties, giving rise to significant inaccuracies in outlying areas.

Map Name(s) and Date(s)

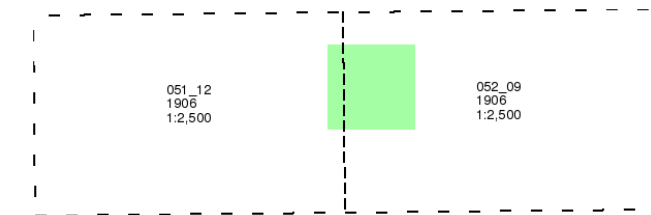

Historical Map - Segment B10

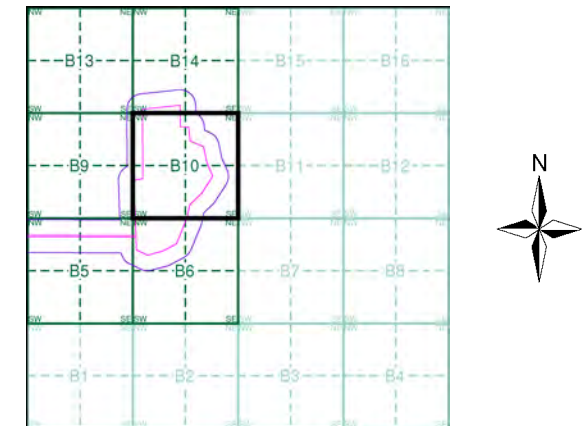

Order Details

Order Number: 297990273_1_1
 Customer Ref: 21-1088.04
 National Grid Reference: 492030, 382680
 Slice: B
 Site Area (Ha): 469.98
 Search Buffer (m): 100

Site Details

Cottam

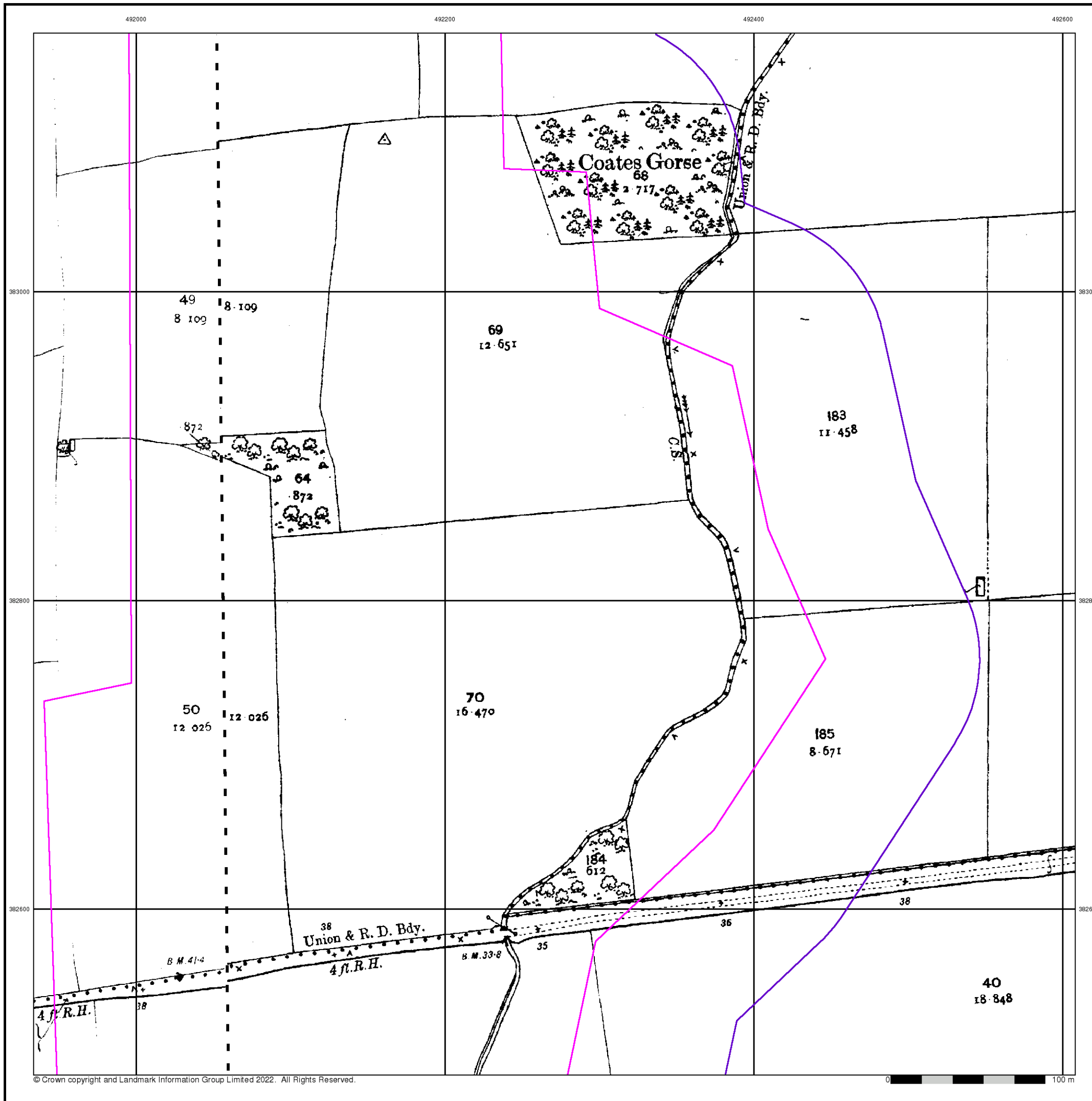

Ordnance Survey Plan

Published 1974

Source map scale - 1:2,500

The historical maps shown were reproduced from maps predominantly held at the scale adopted for England, Wales and Scotland in the 1840's. In 1854 the 1:2,500 scale was adopted for mapping urban areas and by 1896 it covered the whole of what were considered to be the cultivated parts of Great Britain. The published date given below is often some years later than the surveyed date. Before 1938, all OS maps were based on the Cassini Projection, with independent surveys of a single county or group of counties, giving rise to significant inaccuracies in outlying areas.

Map Name(s) and Date(s)

SK9183 1974 1:2,500	SK9283 1974 1:2,500
SK9182 1974 1:2,500	SK9282 1974 1:2,500

Historical Map - Segment B10

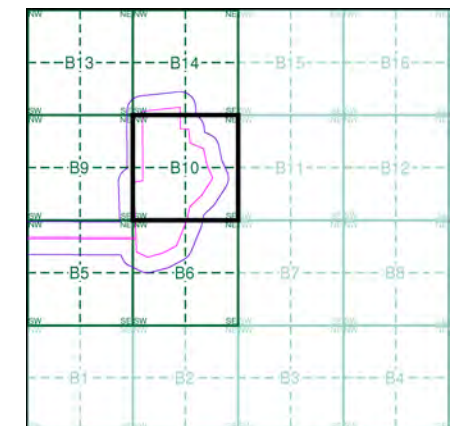

Order Details

Order Number: 297990273_1_1
 Customer Ref: 21-1088.04
 National Grid Reference: 492030, 382680
 Slice: B
 Site Area (Ha): 469.98
 Search Buffer (m): 100

Site Details

Cottam



Large-Scale National Grid Data

Published 1994

Source map scale - 1:2,500

'Large Scale National Grid Data' superseded SIM cards (Ordnance Survey's 'Survey of Information on Microfilm') in 1992, and continued to be produced until 1999. These maps were the fore-runners of digital mapping and so provide detailed information on houses and roads, but tend to show less topographic features such as vegetation. These maps were produced at both 1:2,500 and 1:1,250 scales.

Map Name(s) and Date(s)

SK9183 1994 1:2,500	SK9283 1994 1:2,500
SK9182 1994 1:2,500	SK9282 1994 1:2,500

Historical Map - Segment B10

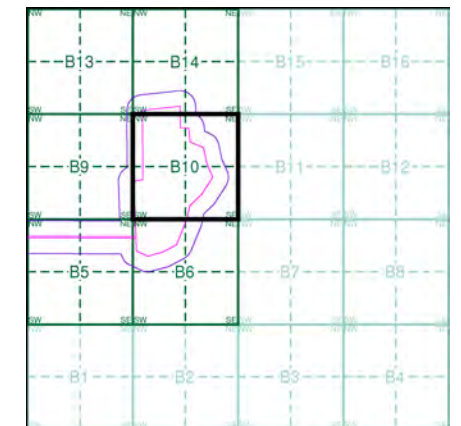

Order Details

Order Number: 297990273_1_1
 Customer Ref: 21-1088.04
 National Grid Reference: 492030, 382680
 Slice: B
 Site Area (Ha): 469.98
 Search Buffer (m): 100

Site Details

Cottam

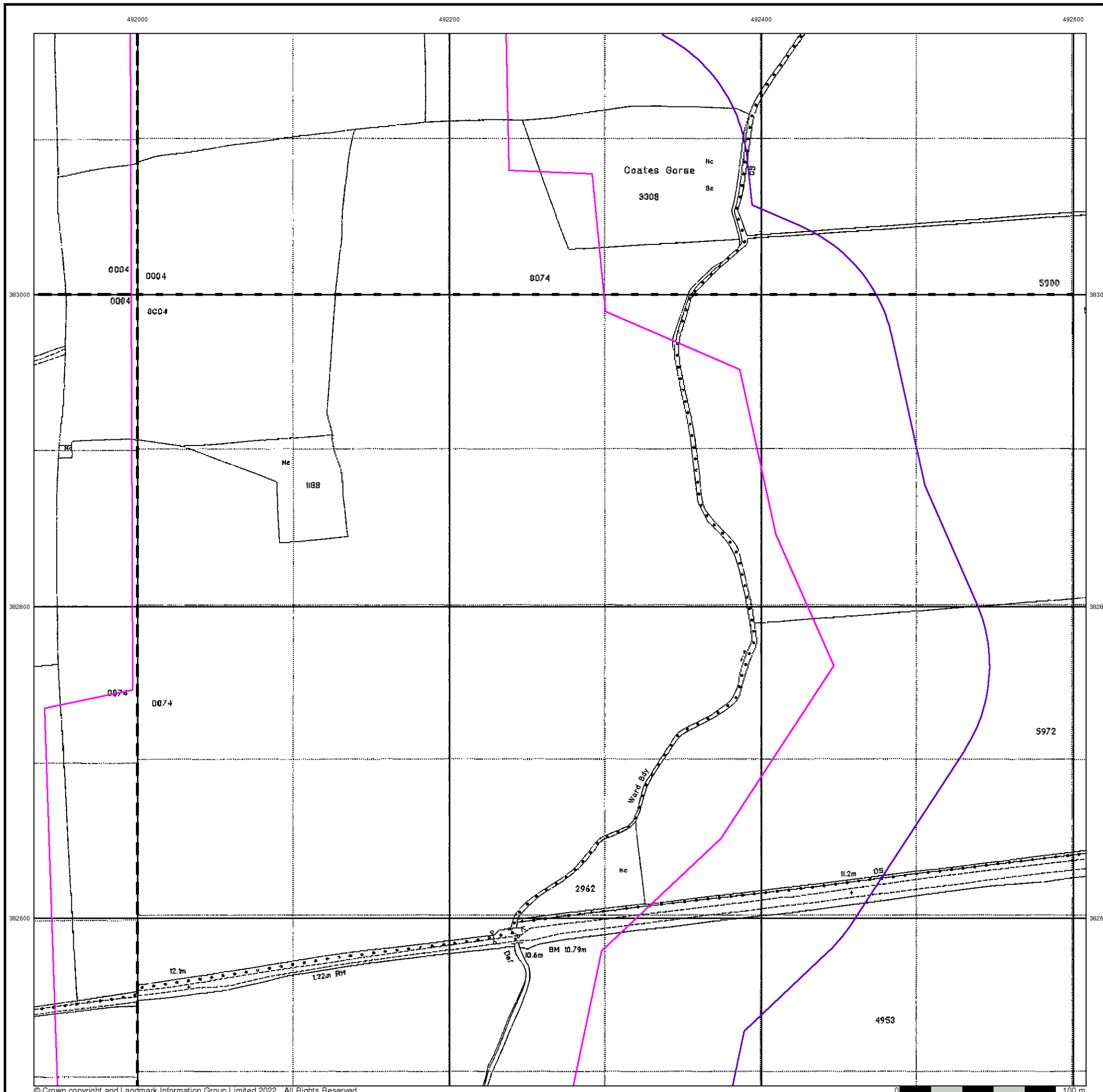

Historical Mapping Legends

Ordnance Survey County Series and Ordnance Survey Plan 1:2,500

Quarry **Gravel Pit** **Sand Pit**
Clay Pit **Shingle** **Refuse Heap**
Sloping Masonry **Flat Rock**
Marsh **Reeds** **Osiers**
Rough Pasture **Furze** **Wood**
Mixed Wood **Brushwood** **Orchard**
Fir **Ford** **Stepping Stones**
Ferry **Waterfall** **Lock**
Trig. Station **Altitude at Trig. Station**
B.M. 325.9 **Bench Mark** **Surface Level**
Arrow denotes flow of water **Antiquities (site of)**
Cutting **Embankment**
Railway crossing Road **Level Crossing** **Road crossing Railway**
Railway crossing River or Canal **Road over single stream** **Road over River or Canal**
County Boundary (Geographical)
County & Civil Parish Boundary
Administrative County & Civil Parish Boundary
County Borough Boundary (England)
Co. Boro. Bdy.
County Burgh Boundary (Scotland)
Co. Burgh Bdy.
BP BS Boundary Post or Stone **P.C.B** Police Call Box
B.R. Bridle Road **P** Pump
E.P Electricity Pylon **S.P** Signal Post
F.B. Foot Bridge **SL** Sluice
F.P. Foot Path **Sp.** Spring
G.P Guide Post or Board **T.C.B** Telephone Call Box
M.S Mile Stone **Tr.** Trough
M.P M.R Mooring Post or Ring **W** Well

Ordnance Survey Plan, Additional SIMs and Supply of Unpublished Survey Information 1:2,500 and 1:1,250

Inactive Quarry, Chalk Pit or Clay Pit **Active Quarry, Chalk Pit or Clay Pit**
Rock **Boulders**
Cliff **Slopes** **Top**
Roofed Building **Glazed Roof Building**
Sloping Masonry **Archway**
Non-Coniferous Tree (surveyed) **Coniferous Tree (surveyed)**
Non-Coniferous Trees (not surveyed) **Coniferous Trees (not surveyed)**
Orchard Tree **Scrub** **Bracken**
Coppice, Osier **Reeds** **Marsh, Saltings**
Rough Grassland **Heath** **Culvert**
Direction of water flow **Bench Mark** **Antiquity (site of)**
Cave Entrance **Triangulation Station** **Electricity Pylon**
Electricity Transmission Line
County Boundary (Geographical)
County & Civil Parish Boundary
Civil Parish Boundary
Admin. County or County Bor. Boundary
London Borough Boundary
Symbol marking point where boundary mereing changes
BH Beer House **P** Pillar, Pole or Post
BP, BS Boundary Post or Stone **PO** Post Office
Cn, C Capstan, Crane **PC** Public Convenience
Chy Chimney **PH** Public House
D Fn Drinking Fountain **Pp** Pump
EI P Electricity Pillar or Post **SB, S Br** Signal Box or Bridge
FAP Fire Alarm Pillar **SP, SL** Signal Post or Light
FB Foot Bridge **Spr** Spring
GP Guide Post **Tk** Tank or Track
H Hydrant or Hydraulic **TCB** Telephone Call Box
LC Level Crossing **TCP** Telephone Call Post
MH Manhole **Tr** Trough
MP Mile Post or Mooring Post **Wr Pt, Wr T** Water Point, Water Tap
MS Mile Stone **W** Well
NTL Normal Tidal Limit **Wd Pp** Wind Pump

Large-Scale National Grid Data 1:2,500 and 1:1,250

Cliff **Slopes** **Top**
Rock **Rock (scattered)**
Boulders **Boulders (scattered)**
Positioned Boulder **Scree**
Non-Coniferous Tree (surveyed) **Coniferous Tree (surveyed)**
Non-Coniferous Trees (not surveyed) **Coniferous Trees (not surveyed)**
Orchard Tree **Scrub** **Bracken**
Coppice, Osier **Reeds** **Marsh, Saltings**
Rough Grassland **Heath** **Culvert**
Direction of water flow **Triangulation Station** **Antiquity (site of)**
Electricity Transmission Line **Electricity Pylon**
B.M. 231.60m Bench Mark **Buildings with Building Seed**
Roofed Building **Glazed Roof Building**
Civil parish/community boundary
District boundary
County boundary
Boundary post/stone
Boundary mereing symbol (note: these always appear in opposed pairs or groups of three)
Bks Barracks **P** Pillar, Pole or Post
Bty Battery **PO** Post Office
Cemy Cemetery **PC** Public Convenience
Chy Chimney **Pp** Pump
Cis Cistern **Ppg Sta** Pumping Station
Dismtd Rly Dismantled Railway **PW** Place of Worship
EI Gen Sta Electricity Generating Station **Sewage Ppg Sta** Sewage Pumping Station
EI P Electricity Pole, Pillar **SB, S Br** Signal Box or Bridge
EI Sub Sta Electricity Sub Station **SP, SL** Signal Post or Light
FB Filter Bed **Spr** Spring
Fn / D Fn Fountain / Drinking Ftn. **Tk** Tank or Track
Gas Gov Gas Valve Compound **Tr** Trough
GVC Gas Governor **Wd Pp** Wind Pump
GP Guide Post **Wr Pt, Wr T** Water Point, Water Tap
MH Manhole **Wks** Works (building or area)
MP, MS Mile Post or Mile Stone **W** Well



Historical Mapping & Photography included:

Mapping Type	Scale	Date	Pg
Lincolnshire	1:2,500	1886	2
Lincolnshire	1:2,500	1906	3
Ordnance Survey Plan	1:2,500	1974	4
Large-Scale National Grid Data	1:2,500	1994	5

Historical Map - Segment B13

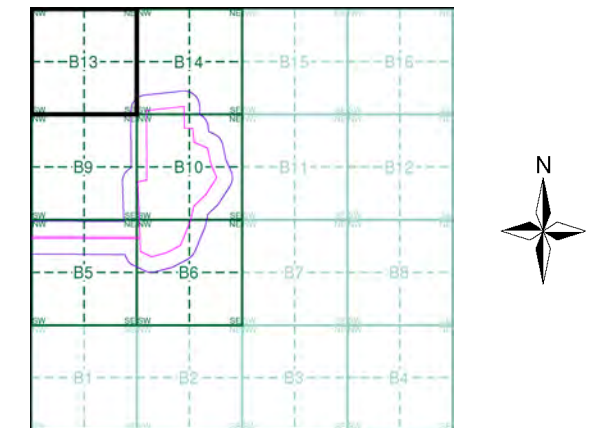

Order Details

Order Number: 297990273_1_1
 Customer Ref: 21-1088.04
 National Grid Reference: 492030, 382680
 Slice: B
 Site Area (Ha): 469.98
 Search Buffer (m): 100

Site Details

Cottam



Tel:
Fax:
Web:

Lincolnshire
Published 1886

Source map scale - 1:2,500

The historical maps shown were reproduced from maps predominantly held at the scale adopted for England, Wales and Scotland in the 1840's. In 1854 the 1:2,500 scale was adopted for mapping urban areas and by 1896 it covered the whole of what were considered to be the cultivated parts of Great Britain. The published date given below is often some years later than the surveyed date. Before 1938, all OS maps were based on the Cassini Projection, with independent surveys of a single county or group of counties, giving rise to significant inaccuracies in outlying areas.

Map Name(s) and Date(s)

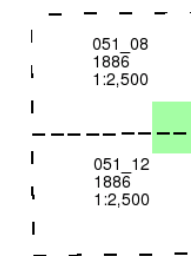

Historical Map - Segment B13

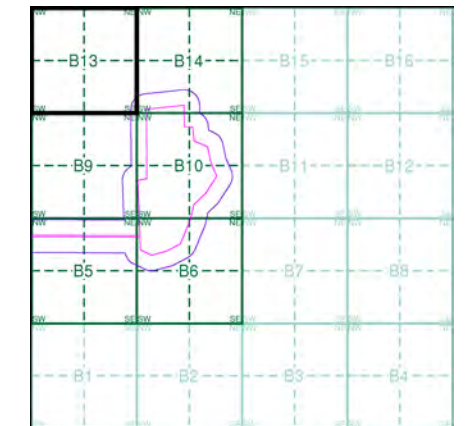

Order Details

Order Number: 297990273_1_1
 Customer Ref: 21-1088.04
 National Grid Reference: 492030, 382680
 Slice: B
 Site Area (Ha): 469.98
 Search Buffer (m): 100

Site Details

Cottam

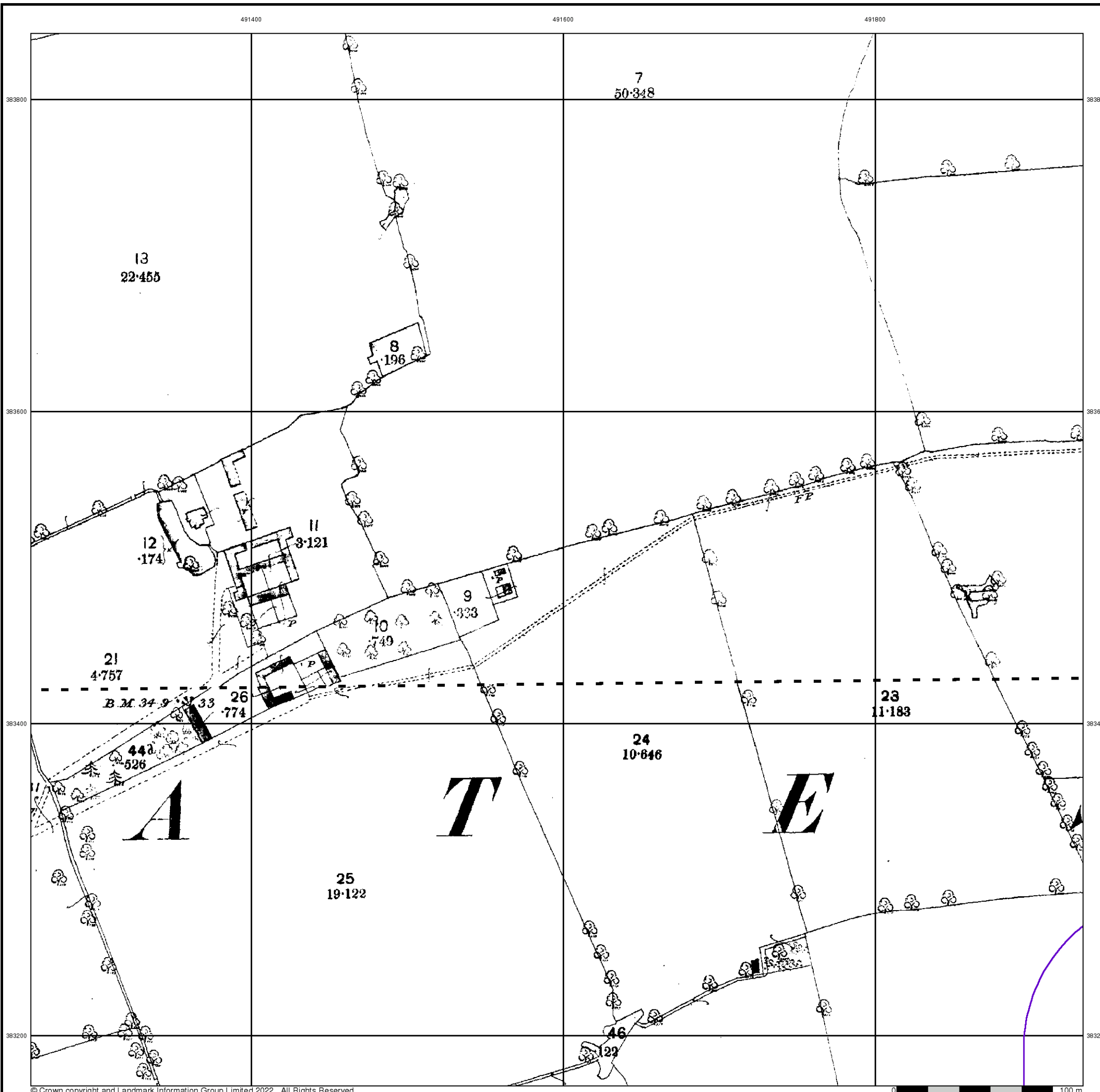

Lincolnshire
Published 1906

Source map scale - 1:2,500

The historical maps shown were reproduced from maps predominantly held at the scale adopted for England, Wales and Scotland in the 1840's. In 1854 the 1:2,500 scale was adopted for mapping urban areas and by 1896 it covered the whole of what were considered to be the cultivated parts of Great Britain. The published date given below is often some years later than the surveyed date. Before 1938, all OS maps were based on the Cassini Projection, with independent surveys of a single county or group of counties, giving rise to significant inaccuracies in outlying areas.

Map Name(s) and Date(s)

051_08	1906	1:2,500
051_12	1906	1:2,500

Historical Map - Segment B13

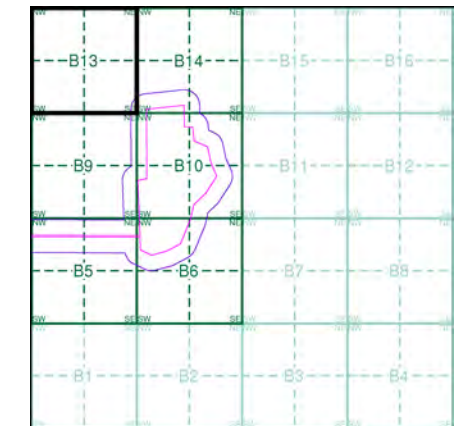

Order Details

Order Number: 297990273_1_1
 Customer Ref: 21-1088.04
 National Grid Reference: 492030, 382680
 Slice: B
 Site Area (Ha): 469.98
 Search Buffer (m): 100

Site Details

Cottam

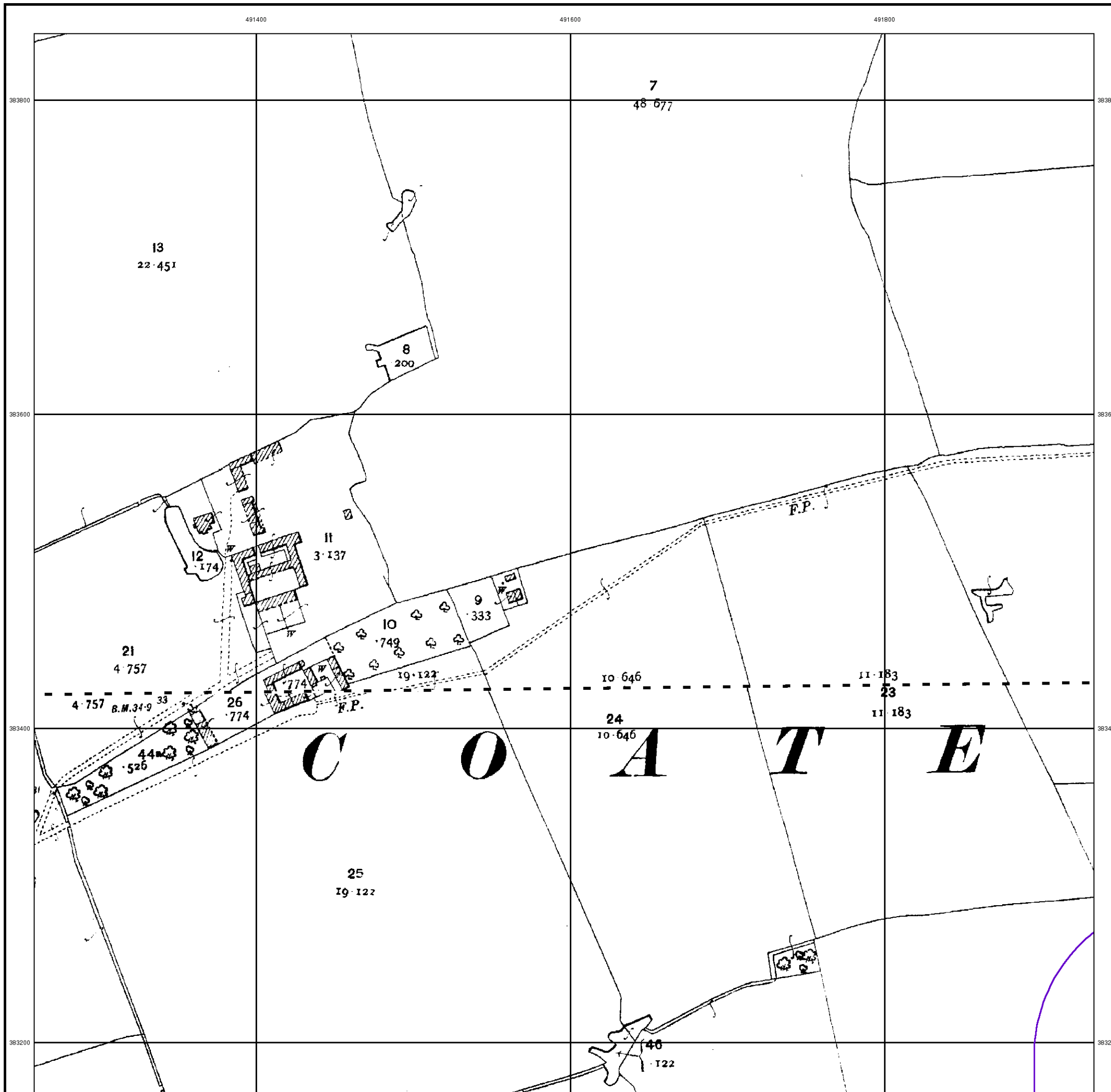

Ordnance Survey Plan

Published 1974

Source map scale - 1:2,500

The historical maps shown were reproduced from maps predominantly held at the scale adopted for England, Wales and Scotland in the 1840's. In 1854 the 1:2,500 scale was adopted for mapping urban areas and by 1896 it covered the whole of what were considered to be the cultivated parts of Great Britain. The published date given below is often some years later than the surveyed date. Before 1938, all OS maps were based on the Cassini Projection, with independent surveys of a single county or group of counties, giving rise to significant inaccuracies in outlying areas.

Map Name(s) and Date(s)

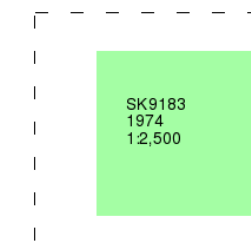

Historical Map - Segment B13

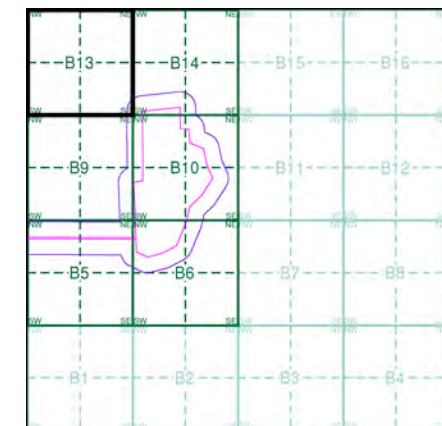

Order Details

Order Number: 297990273_1_1
 Customer Ref: 21-1088.04
 National Grid Reference: 492030, 382680
 Slice: B
 Site Area (Ha): 469.98
 Search Buffer (m): 100

Site Details

Cottam



Large-Scale National Grid Data

Published 1994

Source map scale - 1:2,500

'Large Scale National Grid Data' superseded SIM cards (Ordnance Survey's 'Survey of Information on Microfilm') in 1992, and continued to be produced until 1999. These maps were the fore-runners of digital mapping and so provide detailed information on houses and roads, but tend to show less topographic features such as vegetation. These maps were produced at both 1:2,500 and 1:1,250 scales.

Map Name(s) and Date(s)

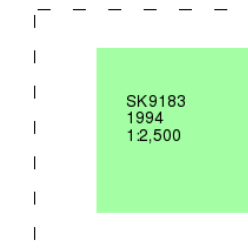

Historical Map - Segment B13

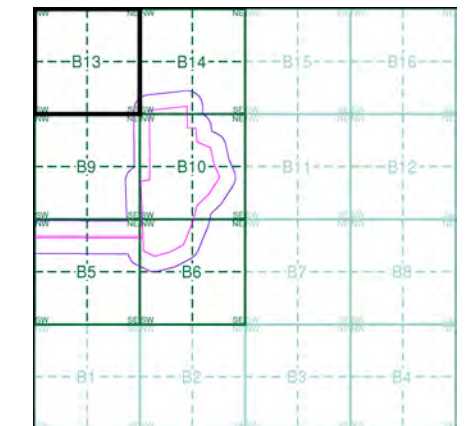

Order Details

Order Number: 297990273_1_1
 Customer Ref: 21-1088.04
 National Grid Reference: 492030, 382680
 Slice: B
 Site Area (Ha): 469.98
 Search Buffer (m): 100

Site Details

Cottam

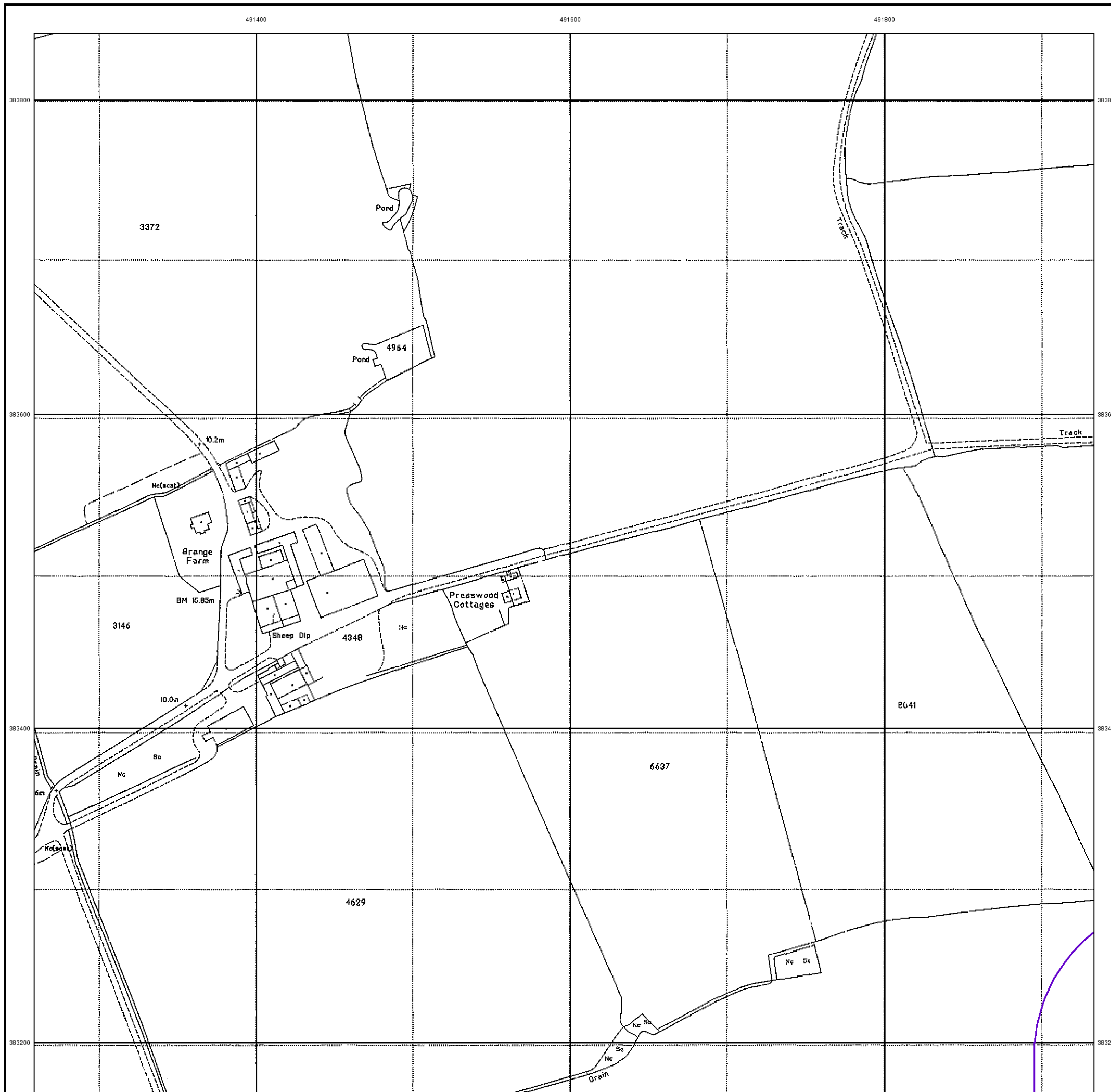

Historical Mapping Legends

Ordnance Survey County Series and Ordnance Survey Plan 1:2,500

Quarry **Gravel Pit** **Sand Pit**
Clay Pit **Shingle** **Refuse Heap**
Sloping Masonry **Flat Rock**
Marsh **Reeds** **Osiers**
Rough Pasture **Furze** **Wood**
Mixed Wood **Brushwood** **Orchard**
Fir **Ford** **Stepping Stones**
Ferry **Waterfall** **Lock**
Trig. Station **Altitude at Trig. Station**
B.M. 325.9 **Bench Mark** **Surface Level**
Arrow denotes flow of water **Antiquities (site of)**
Cutting **Embankment**
Railway crossing Road **Level Crossing** **Road crossing Railway**
Railway crossing River or Canal **Road over single stream** **Road over River or Canal**
County Boundary (Geographical)
County & Civil Parish Boundary
Administrative County & Civil Parish Boundary
County Borough Boundary (England)
Co. Boro. Bdy.
County Burgh Boundary (Scotland)
Co. Burgh Bdy.
BP BS Boundary Post or Stone **P.C.B** Police Call Box
B.R. Bridle Road **P** Pump
E.P Electricity Pylon **S.P** Signal Post
F.B. Foot Bridge **SL** Sluice
F.P. Foot Path **Sp.** Spring
G.P Guide Post or Board **T.C.B** Telephone Call Box
M.S Mile Stone **Tr.** Trough
M.P M.R Mooring Post or Ring **W** Well

Ordnance Survey Plan, Additional SIMs and Supply of Unpublished Survey Information 1:2,500 and 1:1,250

Inactive Quarry, Chalk Pit or Clay Pit **Active Quarry, Chalk Pit or Clay Pit**
Rock **Boulders**
Cliff **Slopes** **Top**
Roofed Building **Glazed Roof Building**
Sloping Masonry **Archway**
Non-Coniferous Tree (surveyed) **Coniferous Tree (surveyed)**
Non-Coniferous Trees (not surveyed) **Coniferous Trees (not surveyed)**
Orchard Tree **Scrub** **Bracken**
Coppice, Osier **Reeds** **Marsh, Saltings**
Rough Grassland **Heath** **Culvert**
Direction of water flow **Bench Mark** **Antiquity (site of)**
Cave Entrance **Triangulation Station** **Electricity Pylon**
Electricity Transmission Line
County Boundary (Geographical)
County & Civil Parish Boundary
Civil Parish Boundary
Admin. County or County Bor. Boundary
London Borough Boundary
Symbol marking point where boundary mereing changes
BH Beer House **P** Pillar, Pole or Post
BP, BS Boundary Post or Stone **PO** Post Office
Cn, C Capstan, Crane **PC** Public Convenience
Chy Chimney **PH** Public House
D Fn Drinking Fountain **Pp** Pump
EI P Electricity Pillar or Post **SB, S Br** Signal Box or Bridge
FAP Fire Alarm Pillar **SP, SL** Signal Post or Light
FB Foot Bridge **Spr** Spring
GP Guide Post **Tk** Tank or Track
H Hydrant or Hydraulic **TCB** Telephone Call Box
LC Level Crossing **TCP** Telephone Call Post
MH Manhole **Tr** Trough
MP Mile Post or Mooring Post **Wr Pt, Wr T** Water Point, Water Tap
MS Mile Stone **W** Well
NTL Normal Tidal Limit **Wd Pp** Wind Pump

Large-Scale National Grid Data 1:2,500 and 1:1,250

Cliff **Slopes** **Top**
Rock **Rock (scattered)**
Boulders **Boulders (scattered)**
Positioned Boulder **Scree**
Non-Coniferous Tree (surveyed) **Coniferous Tree (surveyed)**
Non-Coniferous Trees (not surveyed) **Coniferous Trees (not surveyed)**
Orchard Tree **Scrub** **Bracken**
Coppice, Osier **Reeds** **Marsh, Saltings**
Rough Grassland **Heath** **Culvert**
Direction of water flow **Triangulation Station** **Antiquity (site of)**
Electricity Transmission Line **Electricity Pylon**
B.M. 231.60m Bench Mark **Buildings with Building Seed**
Roofed Building **Glazed Roof Building**
Civil parish/community boundary
District boundary
County boundary
Boundary post/stone
Boundary mereing symbol (note: these always appear in opposed pairs or groups of three)
Bks Barracks **P** Pillar, Pole or Post
Bty Battery **PO** Post Office
Cemy Cemetery **PC** Public Convenience
Chy Chimney **Pp** Pump
Cis Cistern **Ppg Sta** Pumping Station
Dismtd Rly Dismantled Railway **PW** Place of Worship
EI Gen Sta Electricity Generating Station **Sewage Ppg Sta** Sewage Pumping Station
EI P Electricity Pole, Pillar **SB, S Br** Signal Box or Bridge
EI Sub Sta Electricity Sub Station **SP, SL** Signal Post or Light
FB Filter Bed **Spr** Spring
Fn / D Fn Fountain / Drinking Ftn. **Tk** Tank or Track
Gas Gov Gas Valve Compound **Tr** Trough
GVC Gas Governor **Wd Pp** Wind Pump
GP Guide Post **Wr Pt, Wr T** Water Point, Water Tap
MH Manhole **Wks** Works (building or area)
MP, MS Mile Post or Mile Stone **W** Well



Historical Mapping & Photography included:

Mapping Type	Scale	Date	Pg
Lincolnshire	1:2,500	1886	2
Lincolnshire	1:2,500	1906	3
Ordnance Survey Plan	1:2,500	1974	4
Large-Scale National Grid Data	1:2,500	1994	5

Historical Map - Segment B14

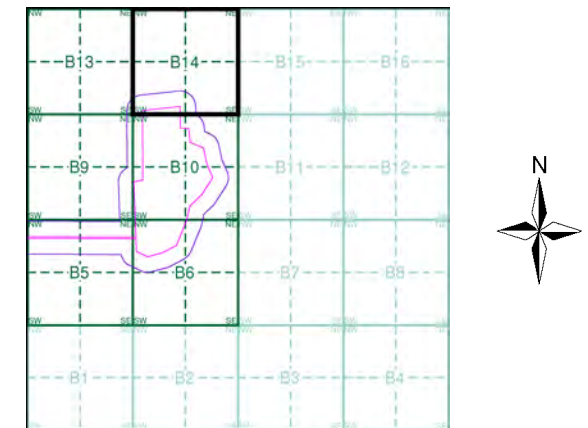

Order Details

Order Number: 297990273_1_1
 Customer Ref: 21-1088.04
 National Grid Reference: 492030, 382680
 Slice: B
 Site Area (Ha): 469.98
 Search Buffer (m): 100

Site Details

Cottam



Tel:
Fax:
Web:

Lincolnshire
Published 1886

Source map scale - 1:2,500

The historical maps shown were reproduced from maps predominantly held at the scale adopted for England, Wales and Scotland in the 1840's. In 1854 the 1:2,500 scale was adopted for mapping urban areas and by 1896 it covered the whole of what were considered to be the cultivated parts of Great Britain. The published date given below is often some years later than the surveyed date. Before 1938, all OS maps were based on the Cassini Projection, with independent surveys of a single county or group of counties, giving rise to significant inaccuracies in outlying areas.

Map Name(s) and Date(s)

051_08 1886 1:2,500	052_05 1886 1:2,500
051_12 1886 1:2,500	052_09 1886 1:2,500

Historical Map - Segment B14

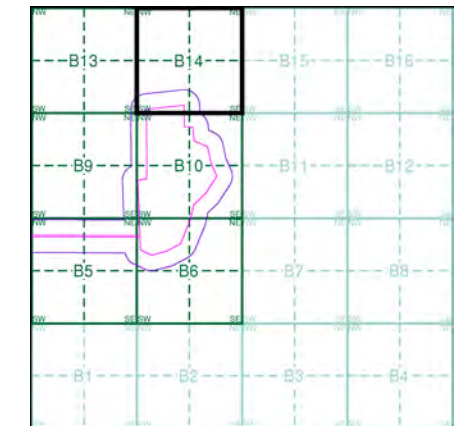

Order Details

Order Number: 297990273_1_1
Customer Ref: 21-1088.04
National Grid Reference: 492030, 382680
Slice: B
Site Area (Ha): 469.98
Search Buffer (m): 100

Site Details

Cottam

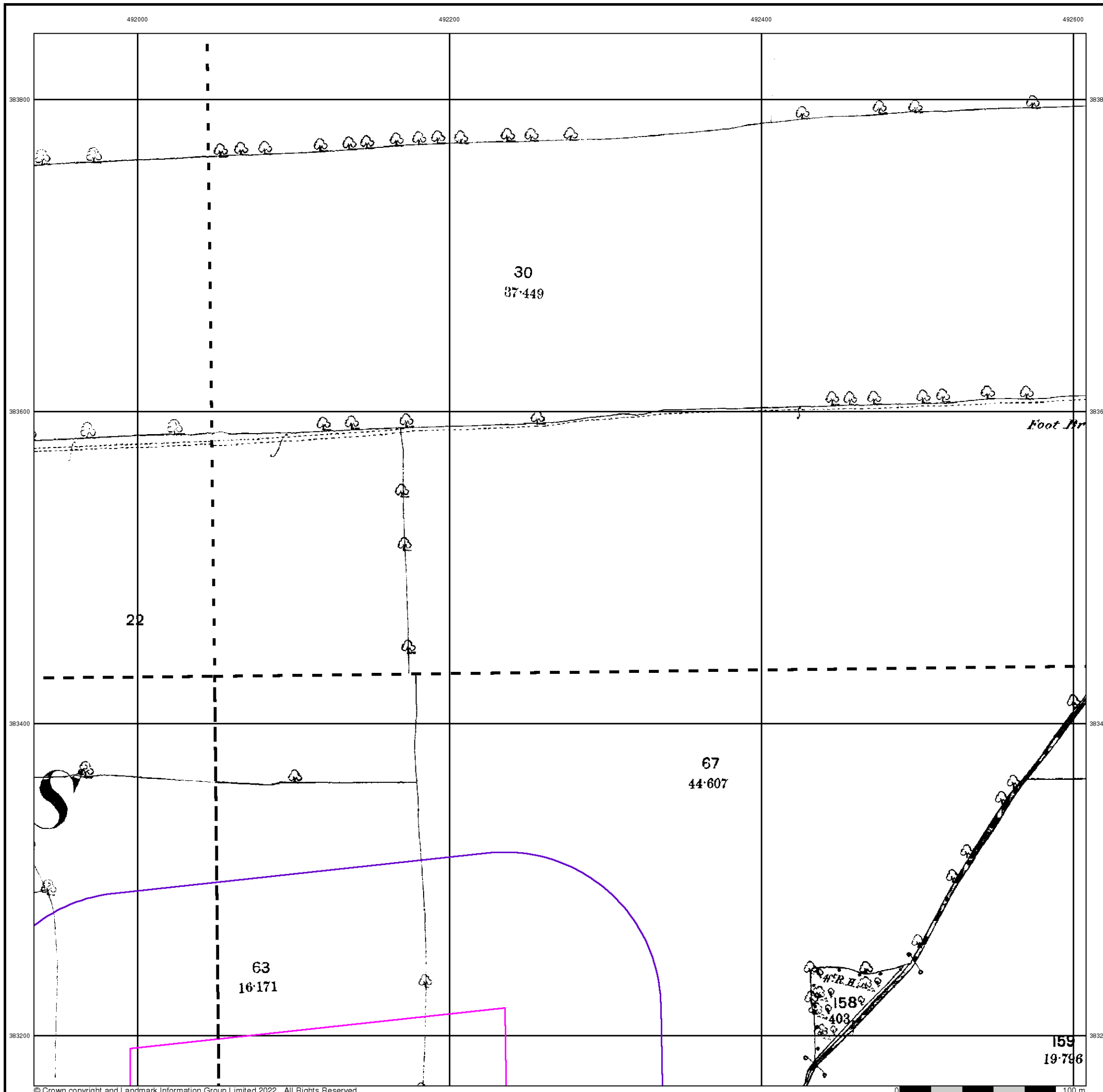

Lincolnshire
Published 1906

Source map scale - 1:2,500

The historical maps shown were reproduced from maps predominantly held at the scale adopted for England, Wales and Scotland in the 1840's. In 1854 the 1:2,500 scale was adopted for mapping urban areas and by 1896 it covered the whole of what were considered to be the cultivated parts of Great Britain. The published date given below is often some years later than the surveyed date. Before 1938, all OS maps were based on the Cassini Projection, with independent surveys of a single county or group of counties, giving rise to significant inaccuracies in outlying areas.

Map Name(s) and Date(s)

051_08 1906 1:2,500	052_05 1906 1:2,500
051_12 1906 1:2,500	052_09 1906 1:2,500

Historical Map - Segment B14

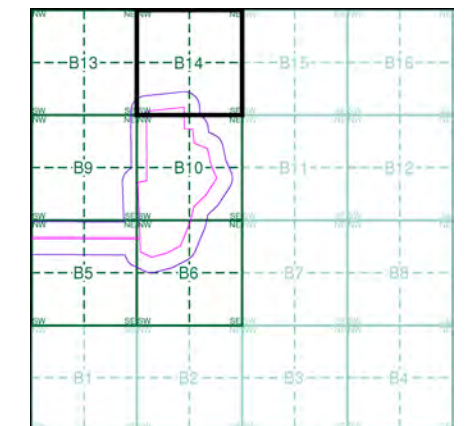

Order Details

Order Number: 297990273_1_1
Customer Ref: 21-1088.04
National Grid Reference: 492030, 382680
Slice: B
Site Area (Ha): 469.98
Search Buffer (m): 100

Site Details

Cottam



Ordnance Survey Plan

Published 1974

Source map scale - 1:2,500

The historical maps shown were reproduced from maps predominantly held at the scale adopted for England, Wales and Scotland in the 1840's. In 1854 the 1:2,500 scale was adopted for mapping urban areas and by 1896 it covered the whole of what were considered to be the cultivated parts of Great Britain. The published date given below is often some years later than the surveyed date. Before 1938, all OS maps were based on the Cassini Projection, with independent surveys of a single county or group of counties, giving rise to significant inaccuracies in outlying areas.

Map Name(s) and Date(s)

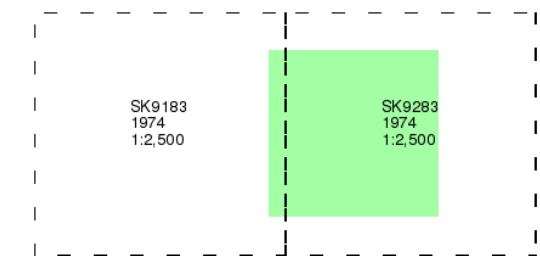

Historical Map - Segment B14

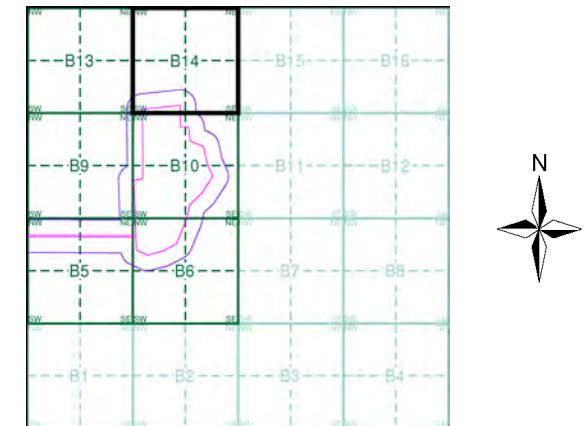

Order Details

Order Number: 297990273_1_1
 Customer Ref: 21-1088.04
 National Grid Reference: 492030, 382680
 Slice: B
 Site Area (Ha): 469.98
 Search Buffer (m): 100

Site Details

Cottam

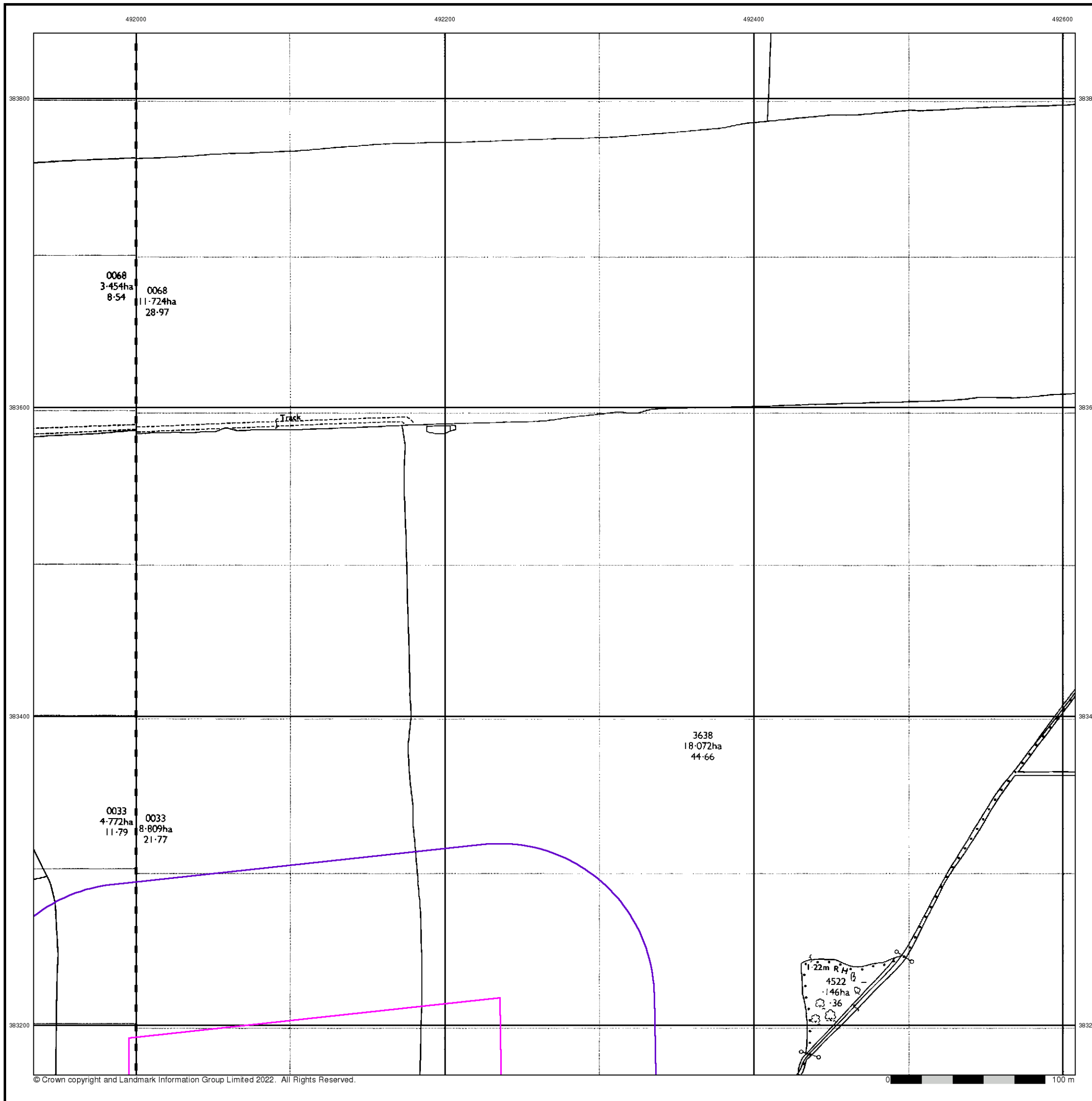

Large-Scale National Grid Data

Published 1994

Source map scale - 1:2,500

'Large Scale National Grid Data' superseded SIM cards (Ordnance Survey's 'Survey of Information on Microfilm') in 1992, and continued to be produced until 1999. These maps were the fore-runners of digital mapping and so provide detailed information on houses and roads, but tend to show less topographic features such as vegetation. These maps were produced at both 1:2,500 and 1:1,250 scales.

Map Name(s) and Date(s)

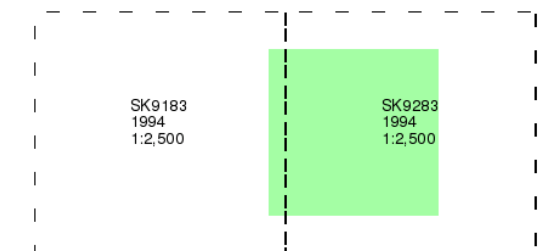

Historical Map - Segment B14

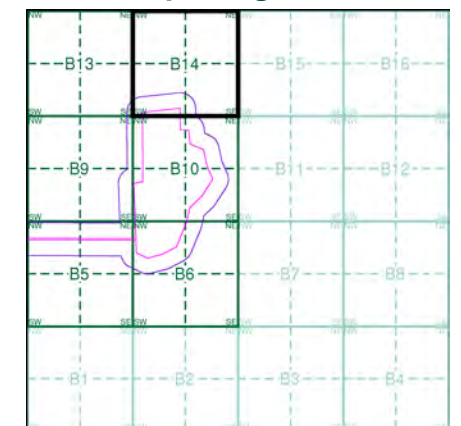

Order Details

Order Number: 297990273_1_1
 Customer Ref: 21-1088.04
 National Grid Reference: 492030, 382680
 Slice: B
 Site Area (Ha): 469.98
 Search Buffer (m): 100

Site Details

Cottam

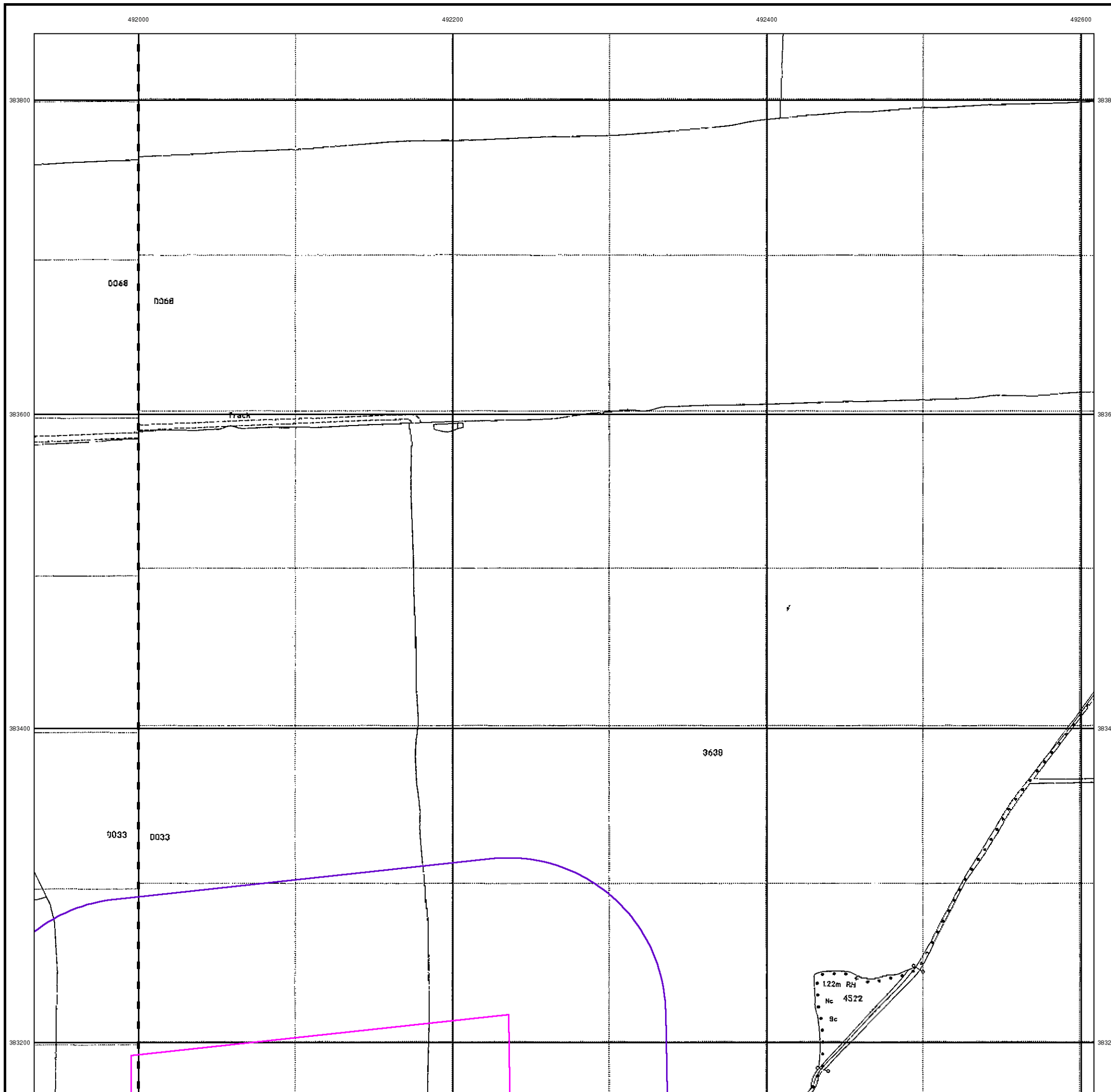

Historical Mapping Legends

Ordnance Survey County Series 1:10,560

	Gravel Pit		Sand Pit		Other Pits
	Quarry		Shingle		Orchard
	Osiers		Reeds		Marsh
	Mixed Wood		Deciduous		Brushwood
	Fir		Furze		Rough Pasture
	Arrow denotes flow of water		Trigonometrical Station		
	Site of Antiquities		Bench Mark		
	Pump, Guide Post, Signal Post		Well, Spring, Boundary Post		
	-285 Surface Level				
	Sketched Contour		Instrumental Contour		
	Main Roads		Minor Roads		
	Sunken Road		Raised Road		
	Road over Railway		Railway over River		
	Railway over Road		Level Crossing		
	Road over River or Canal		Road over Stream		
	Road over Stream				
	County Boundary (Geographical)				
	County & Civil Parish Boundary				
	Administrative County & Civil Parish Boundary				
	County Borough Boundary (England)				
	County Burgh Boundary (Scotland)				
	Rural District Boundary				
	Civil Parish Boundary				

Ordnance Survey Plan 1:10,000

	Chalk Pit, Clay Pit or Quarry		Gravel Pit
	Sand Pit		Disused Pit or Quarry
	Refuse or Slag Heap		Lake, Loch or Pond
	Dunes		Boulders
	Coniferous Trees		Non-Coniferous Trees
	Orchard		Scrub
	Coppice		Heath
	Rough Grassland		Marsh
	Reeds		Saltings
	Building		Glasshouse
	Sloping Masonry		Pylon
	Electricity Transmission Line		Pole
	Cutting		Embankment
	Standard Gauge Multiple Track		Standard Gauge Single Track
	Siding, Tramway or Mineral Line		Narrow Gauge
	Geographical County		
	Administrative County, County Borough or County of City		
	Municipal Borough, Urban or Rural District, Burgh or District Council		
	Borough, Burgh or County Constituency Shown only when not coincident with other boundaries		
	Civil Parish Shown alternately when coincidence of boundaries occurs		
	BP, BS Boundary Post or Stone		Pol Sta Police Station
	Ch Church		PO Post Office
	CH Club House		PC Public Convenience
	F E Sta Fire Engine Station		PH Public House
	FB Foot Bridge		SB Signal Box
	Fn Fountain		Spr Spring
	GP Guide Post		TCB Telephone Call Box
	MP Mile Post		TCP Telephone Call Post
	MS Mile Stone		W Well

1:10,000 Raster Mapping

	Gravel Pit		Refuse tip or slag heap
	Rock		Rock (scattered)
	Boulders		Boulders (scattered)
	Shingle		Mud
	Sand		Sand Pit
	Slopes		Top of cliff
	General detail		Underground detail
	Overhead detail		Narrow gauge railway
	Multi-track railway		Single track railway
	County boundary (England only)		Civil, parish or community boundary
	District, Unitary, Metropolitan, London Borough boundary		Constituency boundary
	Area of wooded vegetation		Non-coniferous trees
	Non-coniferous trees (scattered)		Coniferous trees
	Coniferous trees (scattered)		Positioned tree
	Orchard		Coppice or Osiers
	Rough Grassland		Heath
	Scrub		Marsh, Salt Marsh or Reeds
	Water feature		Flow arrows
	MHW(S) Mean high water (springs)		MLW(S) Mean low water (springs)
	Telephone line (where shown)		Electricity transmission line (with poles)
	Bench mark (where shown)		Triangulation station
	Point feature (e.g. Guide Post or Mile Stone)		Pylon, flare stack or lighting tower
	Site of (antiquity)		Glasshouse
	General Building		Important Building



Historical Mapping & Photography included:

Mapping Type	Scale	Date	Pg
Lincolnshire	1:10,560	1885	2
Lincolnshire	1:10,560	1907	3
Lincolnshire	1:10,560	1947	4
Ordnance Survey Plan	1:10,000	1956	5
Ordnance Survey Plan	1:10,000	1970 - 1979	6
Ordnance Survey Plan	1:10,000	1980 - 1981	7
10K Raster Mapping	1:10,000	2000	8
Street View	Variable		9

Historical Map - Slice C

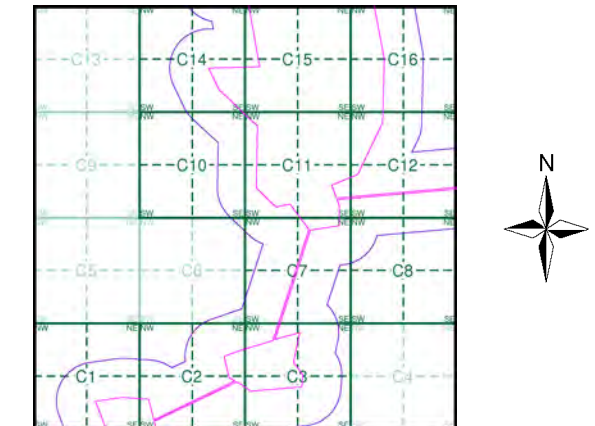

Order Details

Order Number: 297990273_1_1
 Customer Ref: 21-1088.04
 National Grid Reference: 490170, 385250
 Slice: C
 Site Area (Ha): 469.98
 Search Buffer (m): 250

Site Details

Cottam



Tel: [Redacted]
 Fax: [Redacted]
 Web: [Redacted]

Lincolnshire

Published 1885

Source map scale - 1:10,560

The historical maps shown were reproduced from maps predominantly held at the scale adopted for England, Wales and Scotland in the 1840's. In 1854 the 1:2,500 scale was adopted for mapping urban areas; these maps were used to update the 1:10,560 maps. The published date given therefore is often some years later than the surveyed date. Before 1938, all OS maps were based on the Cassini Projection, with independent surveys of a single county or group of counties, giving rise to significant inaccuracies in outlying areas. In the late 1940's, a Provisional Edition was produced, which updated the 1:10,560 mapping from a number of sources. The maps appear unfinished - with all military camps and other strategic sites removed. These maps were initially overprinted with the National Grid. In 1970, the first 1:10,000 maps were produced using the Transverse Mercator Projection. The revision process continued until recently, with new editions appearing every 10 years or so for urban areas.

Map Name(s) and Date(s)

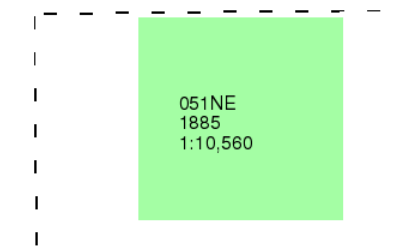

Historical Map - Slice C

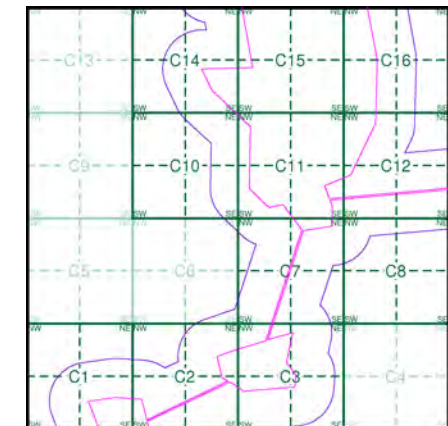

Order Details

Order Number: 297990273_1_1
 Customer Ref: 21-1088.04
 National Grid Reference: 490170, 385250
 Slice: C
 Site Area (Ha): 469.98
 Search Buffer (m): 250

Site Details

Cottam

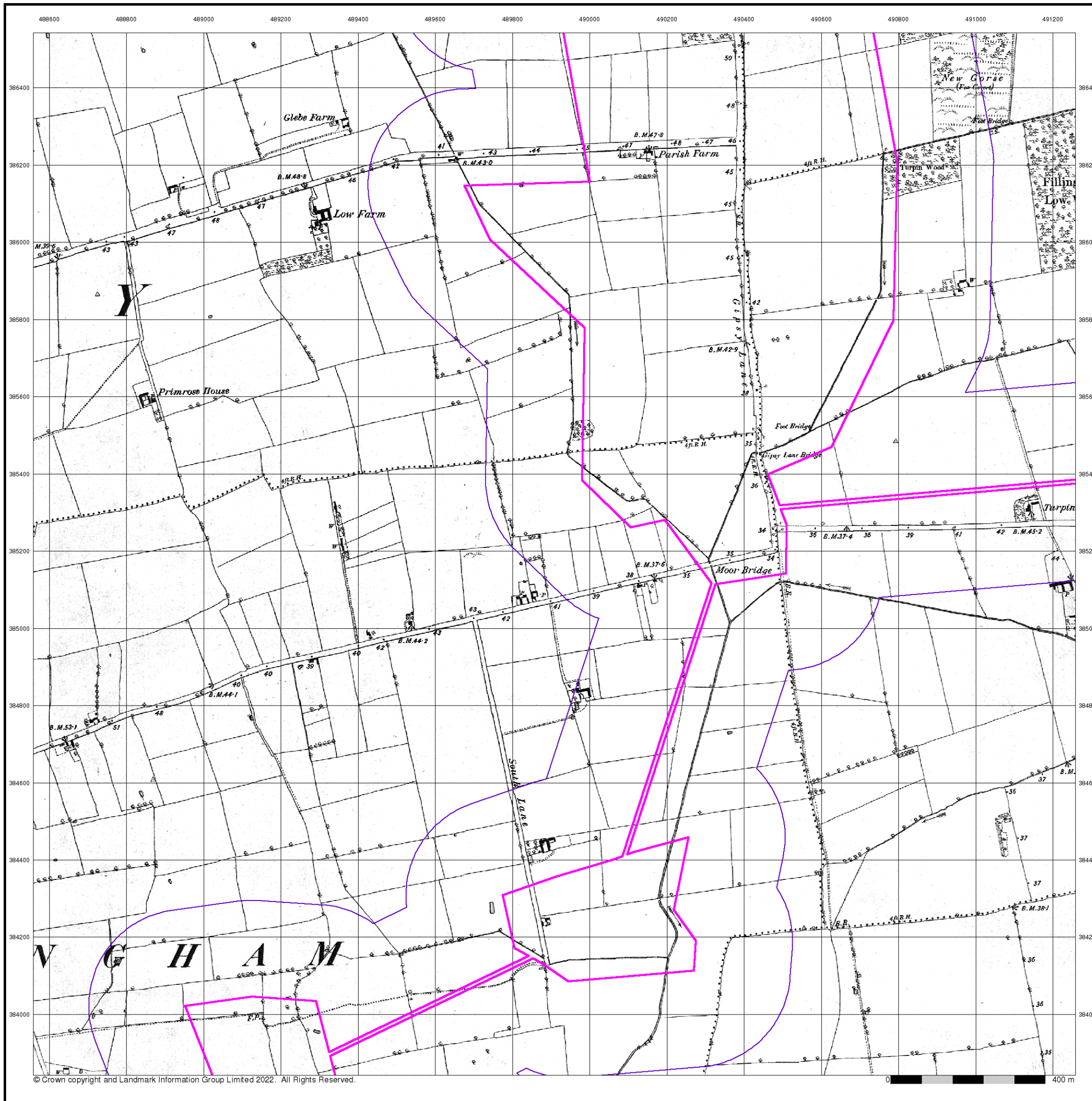

Lincolnshire

Published 1907

Source map scale - 1:10,560

The historical maps shown were reproduced from maps predominantly held at the scale adopted for England, Wales and Scotland in the 1840's. In 1854 the 1:2,500 scale was adopted for mapping urban areas; these maps were used to update the 1:10,560 maps. The published date given therefore is often some years later than the surveyed date. Before 1938, all OS maps were based on the Cassini Projection, with independent surveys of a single county or group of counties, giving rise to significant inaccuracies in outlying areas. In the late 1940's, a Provisional Edition was produced, which updated the 1:10,560 mapping from a number of sources. The maps appear unfinished - with all military camps and other strategic sites removed. These maps were initially overprinted with the National Grid. In 1970, the first 1:10,000 maps were produced using the Transverse Mercator Projection. The revision process continued until recently, with new editions appearing every 10 years or so for urban areas.

Map Name(s) and Date(s)

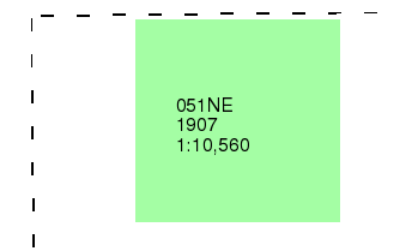

Historical Map - Slice C

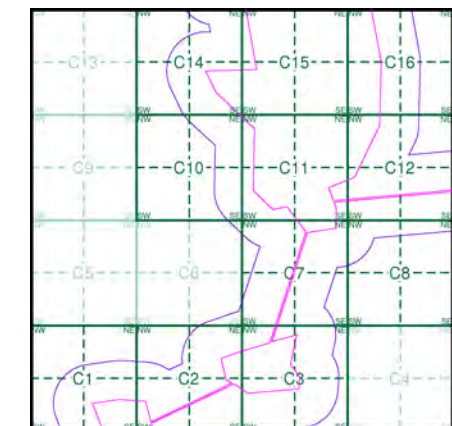

Order Details

Order Number: 297990273_1_1
 Customer Ref: 21-1088.04
 National Grid Reference: 490170, 385250
 Slice: C
 Site Area (Ha): 469.98
 Search Buffer (m): 250

Site Details

Cottam

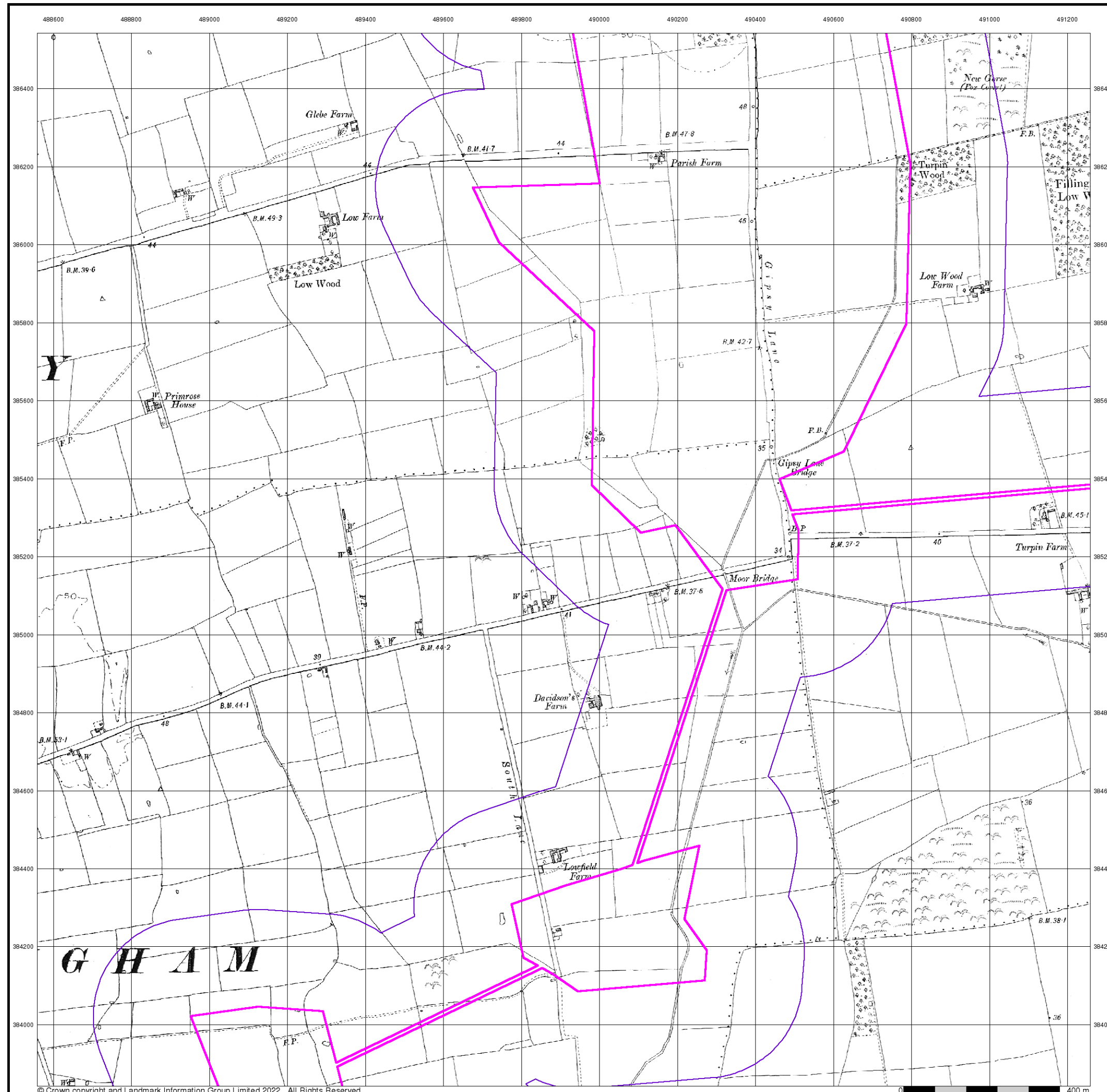

Lincolnshire

Published 1947

Source map scale - 1:10,560

The historical maps shown were reproduced from maps predominantly held at the scale adopted for England, Wales and Scotland in the 1840's. In 1854 the 1:2,500 scale was adopted for mapping urban areas; these maps were used to update the 1:10,560 maps. The published date given therefore is often some years later than the surveyed date. Before 1938, all OS maps were based on the Cassini Projection, with independent surveys of a single county or group of counties, giving rise to significant inaccuracies in outlying areas. In the late 1940's, a Provisional Edition was produced, which updated the 1:10,560 mapping from a number of sources. The maps appear unfinished - with all military camps and other strategic sites removed. These maps were initially overprinted with the National Grid. In 1970, the first 1:10,000 maps were produced using the Transverse Mercator Projection. The revision process continued until recently, with new editions appearing every 10 years or so for urban areas.

Map Name(s) and Date(s)

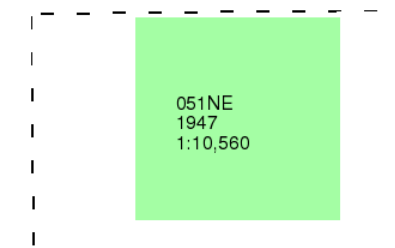

Historical Map - Slice C

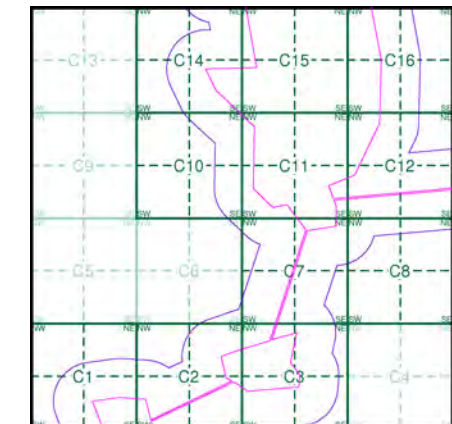

Order Details

Order Number: 297990273_1_1
 Customer Ref: 21-1088.04
 National Grid Reference: 490170, 385250
 Slice: C
 Site Area (Ha): 469.98
 Search Buffer (m): 250

Site Details

Cottam

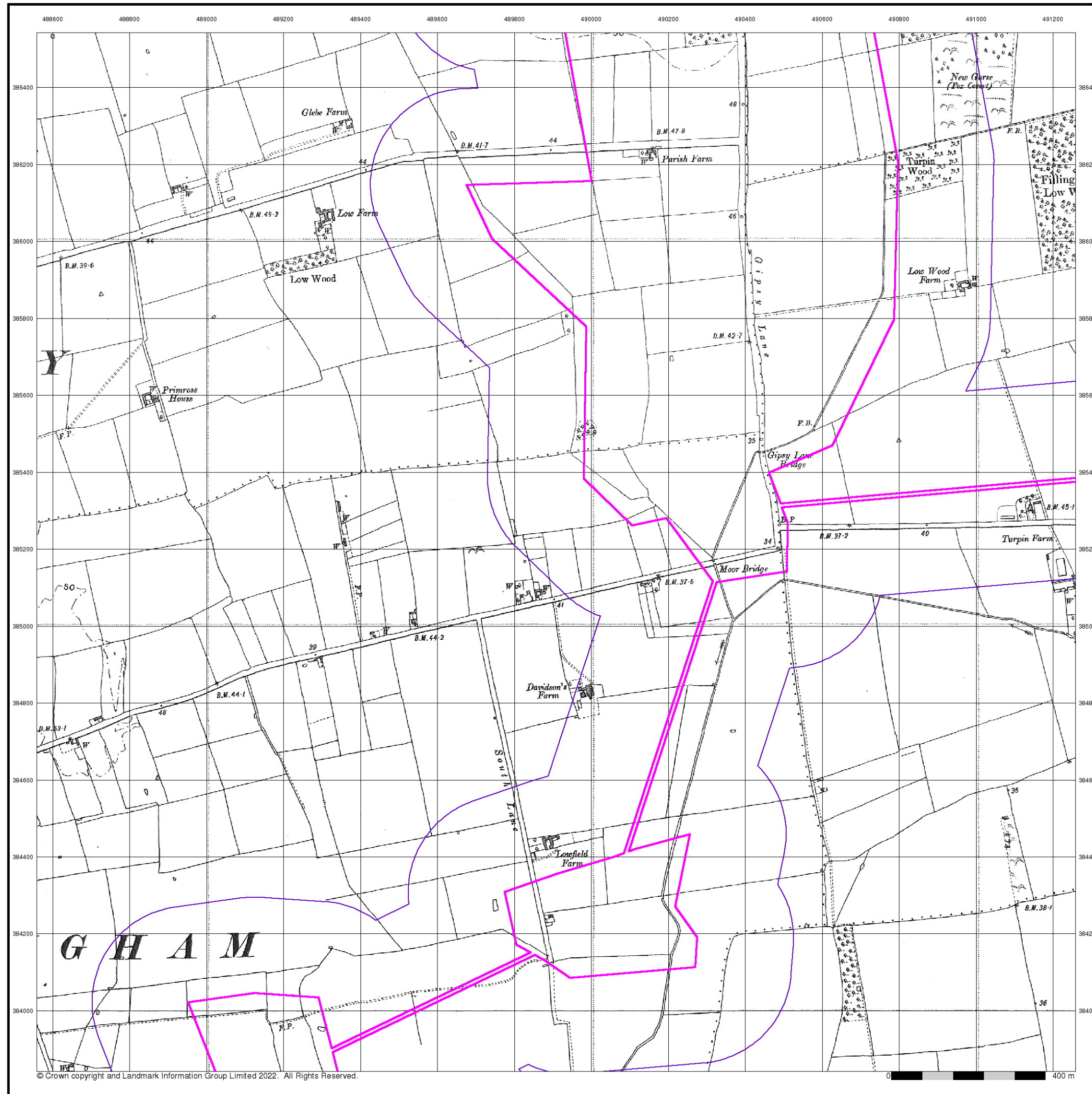

Ordnance Survey Plan

Published 1956

Source map scale - 1:10,000

The historical maps shown were reproduced from maps predominantly held at the scale adopted for England, Wales and Scotland in the 1840's. In 1854 the 1:2,500 scale was adopted for mapping urban areas; these maps were used to update the 1:10,560 maps. The published date given therefore is often some years later than the surveyed date. Before 1938, all OS maps were based on the Cassini Projection, with independent surveys of a single county or group of counties, giving rise to significant inaccuracies in outlying areas. In the late 1940's, a Provisional Edition was produced, which updated the 1:10,560 mapping from a number of sources. The maps appear unfinished - with all military camps and other strategic sites removed. These maps were initially overprinted with the National Grid. In 1970, the first 1:10,000 maps were produced using the Transverse Mercator Projection. The revision process continued until recently, with new editions appearing every 10 years or so for urban areas.

Map Name(s) and Date(s)

SK88NE	SK98NW
1956	1956
1:10,560	1:10,560
SK88SE	SK98SW
1956	1956
1:10,560	1:10,560

Historical Map - Slice C

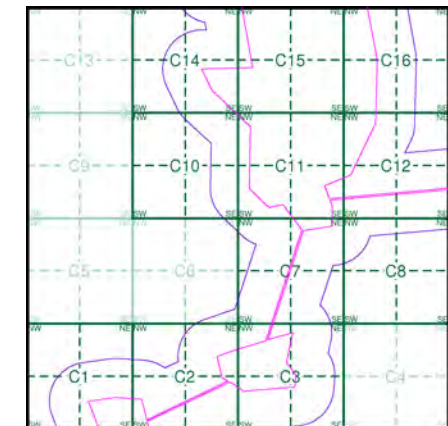

Order Details

Order Number: 297990273_1_1
 Customer Ref: 21-1088.04
 National Grid Reference: 490170, 385250
 Slice: C
 Site Area (Ha): 469.98
 Search Buffer (m): 250

Site Details

Cottam

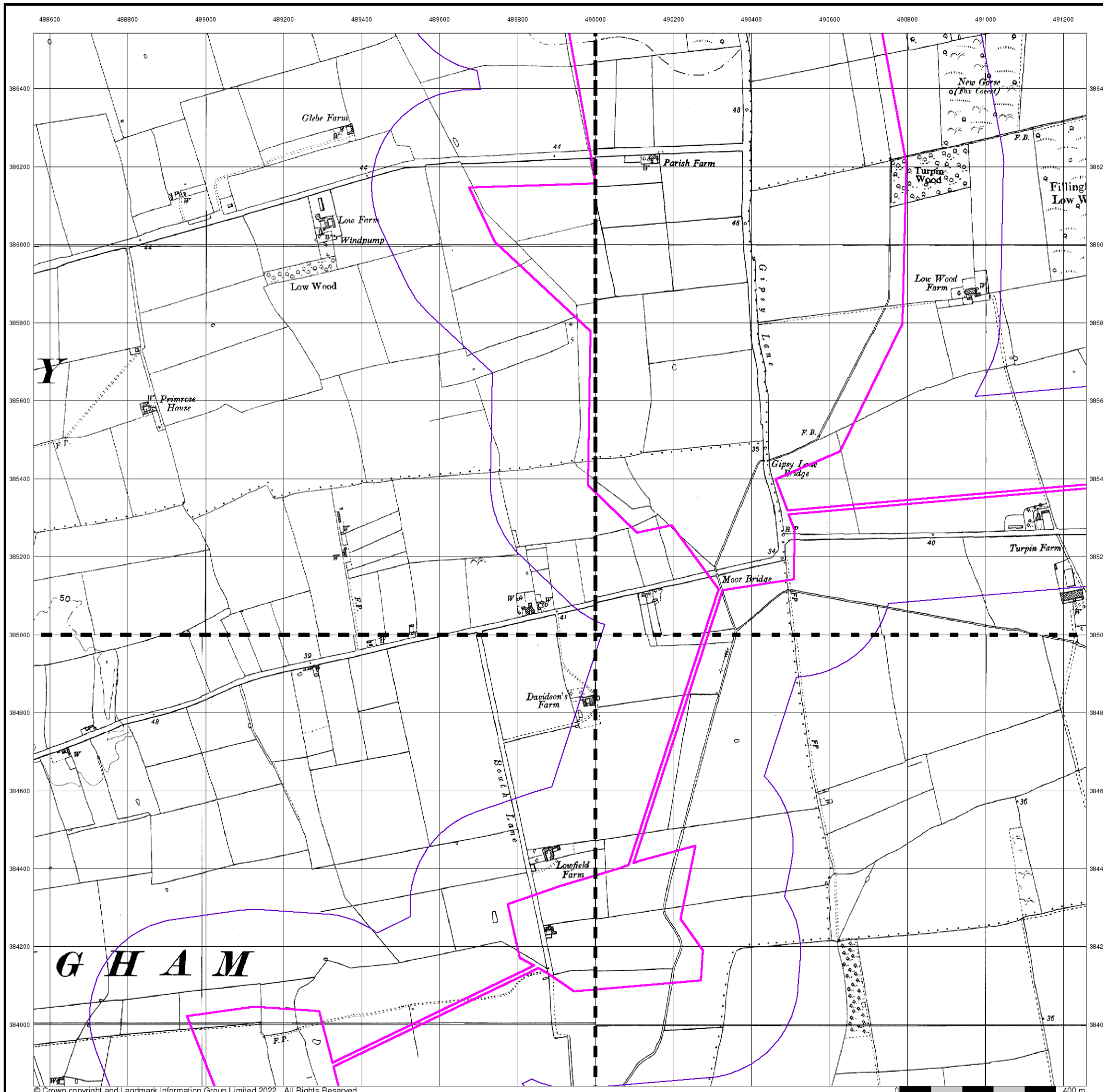

Ordnance Survey Plan
Published 1970 - 1979
Source map scale - 1:10,000

The historical maps shown were reproduced from maps predominantly held at the scale adopted for England, Wales and Scotland in the 1840's. In 1854 the 1:2,500 scale was adopted for mapping urban areas; these maps were used to update the 1:10,560 maps. The published date given therefore is often some years later than the surveyed date. Before 1938, all OS maps were based on the Cassini Projection, with independent surveys of a single county or group of counties, giving rise to significant inaccuracies in outlying areas. In the late 1940's, a Provisional Edition was produced, which updated the 1:10,560 mapping from a number of sources. The maps appear unfinished - with all military camps and other strategic sites removed. These maps were initially overprinted with the National Grid. In 1970, the first 1:10,000 maps were produced using the Transverse Mercator Projection. The revision process continued until recently, with new editions appearing every 10 years or so for urban areas.

Map Name(s) and Date(s)

SK88NE	SK98NW
1970	1979
1:10,560	1:10,000
	
SK98SW	
1979	
1:10,000	

Historical Map - Slice C

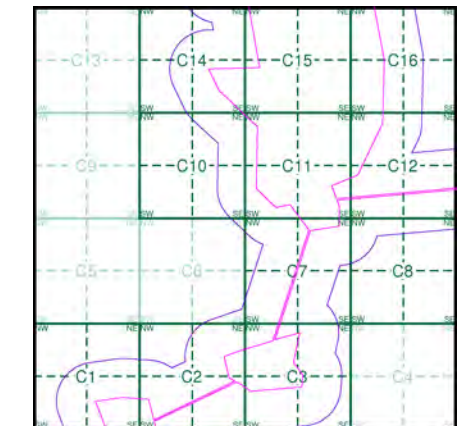

Order Details

Order Number: 297990273_1_1
 Customer Ref: 21-1088.04
 National Grid Reference: 490170, 385250
 Slice: C
 Site Area (Ha): 469.98
 Search Buffer (m): 250

Site Details

Cottam

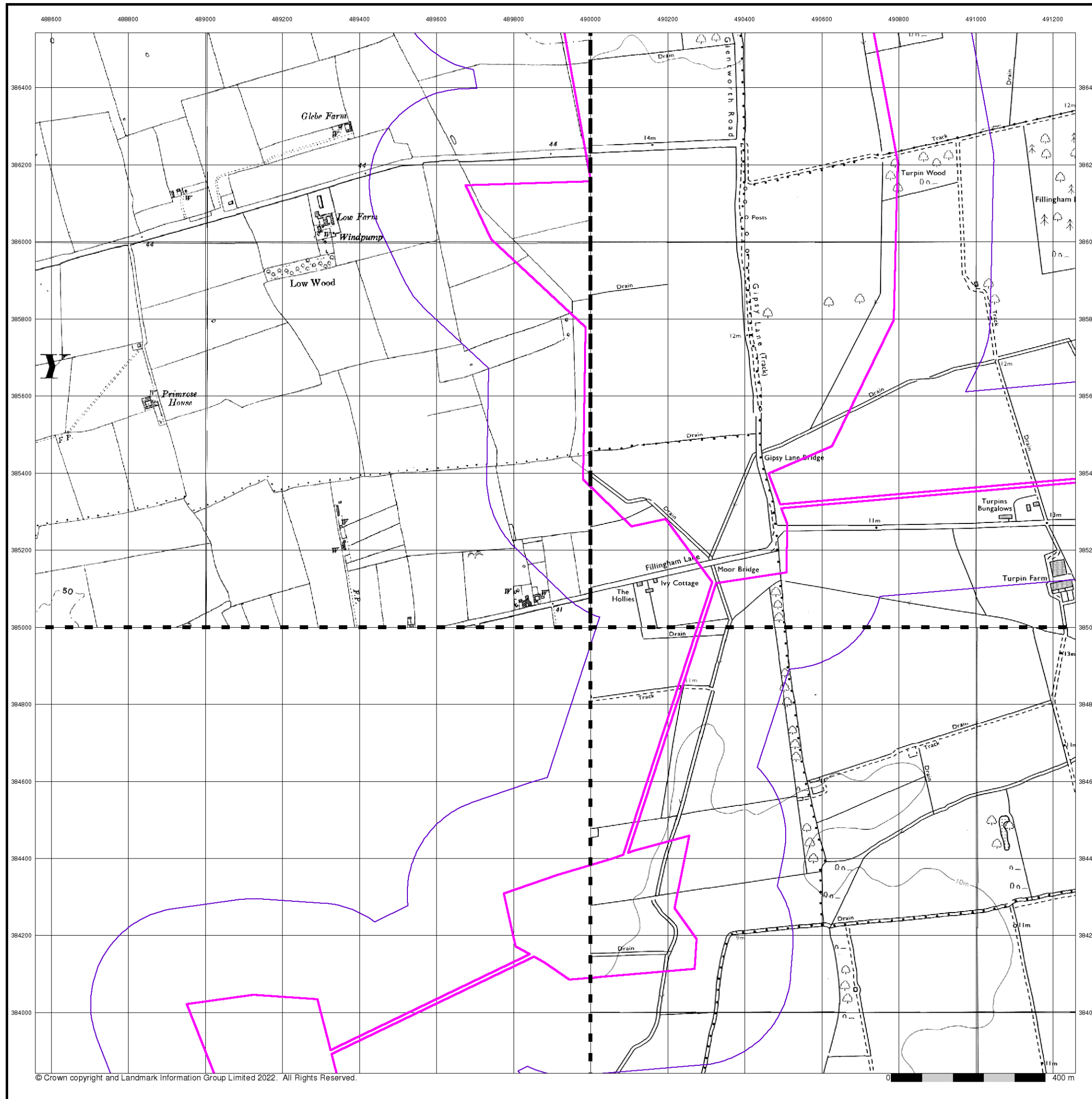

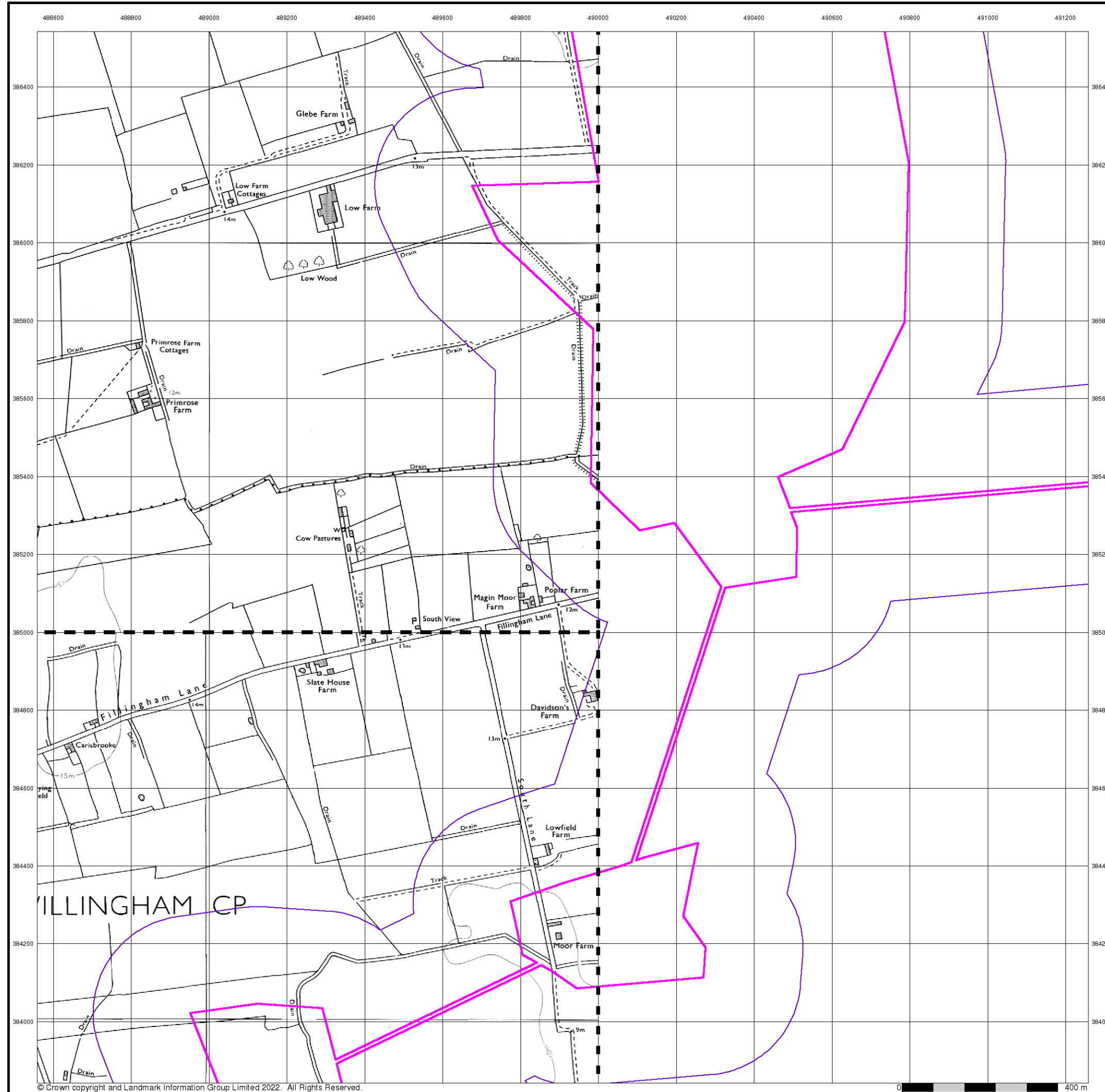

© Crown copyright and Landmark Information Group Limited 2022. All Rights Reserved.



Ordnance Survey Plan

Published 1980 - 1981

Source map scale - 1:10,000

The historical maps shown were reproduced from maps predominantly held at the scale adopted for England, Wales and Scotland in the 1840's. In 1854 the 1:2,500 scale was adopted for mapping urban areas; these maps were used to update the 1:10,560 maps. The published date given therefore is often some years later than the surveyed date. Before 1938, all OS maps were based on the Cassini Projection, with independent surveys of a single county or group of counties, giving rise to significant inaccuracies in outlying areas. In the late 1940's, a Provisional Edition was produced, which updated the 1:10,560 mapping from a number of sources. The maps appear unfinished - with all military camps and other strategic sites removed. These maps were initially overprinted with the National Grid. In 1970, the first 1:10,000 maps were produced using the Transverse Mercator Projection. The revision process continued until recently, with new editions appearing every 10 years or so for urban areas.

Map Name(s) and Date(s)

SK88NE	1980	1:10,000
SK88SE	1981	1:10,000

Historical Map - Slice C

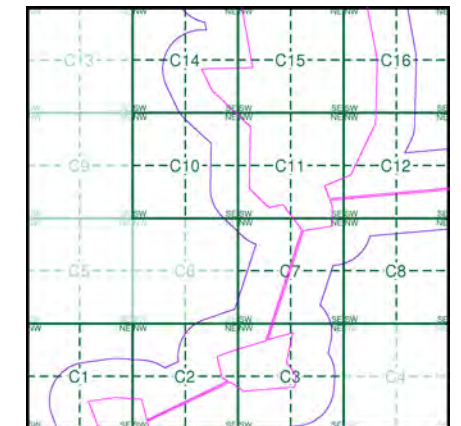

Order Details

Order Number: 297990273_1_1
 Customer Ref: 21-1088.04
 National Grid Reference: 490170, 385250
 Slice: C
 Site Area (Ha): 469.98
 Search Buffer (m): 250

Site Details

Cottam



Tel: [Redacted]
 Fax: [Redacted]
 Web: [Redacted]

10k Raster Mapping

Published 2000

Source map scale - 1:10,000

The historical maps shown were produced from the Ordnance Survey's 1:10,000 colour raster mapping. These maps are derived from Landplan which replaced the old 1:10,000 maps originally published in 1970. The data is highly detailed showing buildings, fences and field boundaries as well as all roads, tracks and paths. Road names are also included together with the relevant road number and classification. Boundary information depiction includes county, unitary authority, district, civil parish and constituency.

Map Name(s) and Date(s)

SK88NE	SK98NW
2000	2000
1:10,000	1:10,000
SK88SE	SK98SW
2000	2000
1:10,000	1:10,000

Historical Map - Slice C

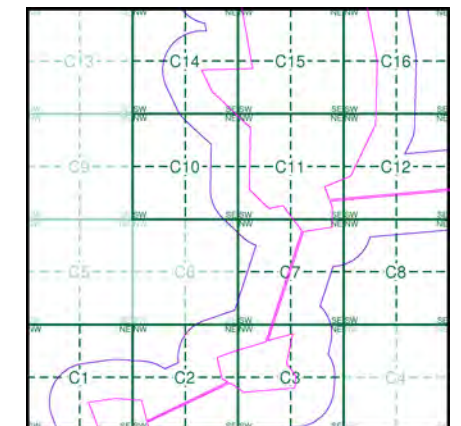

Order Details

Order Number: 297990273_1_1
 Customer Ref: 21-1088.04
 National Grid Reference: 490170, 385250
 Slice: C
 Site Area (Ha): 469.98
 Search Buffer (m): 250

Site Details

Cottam

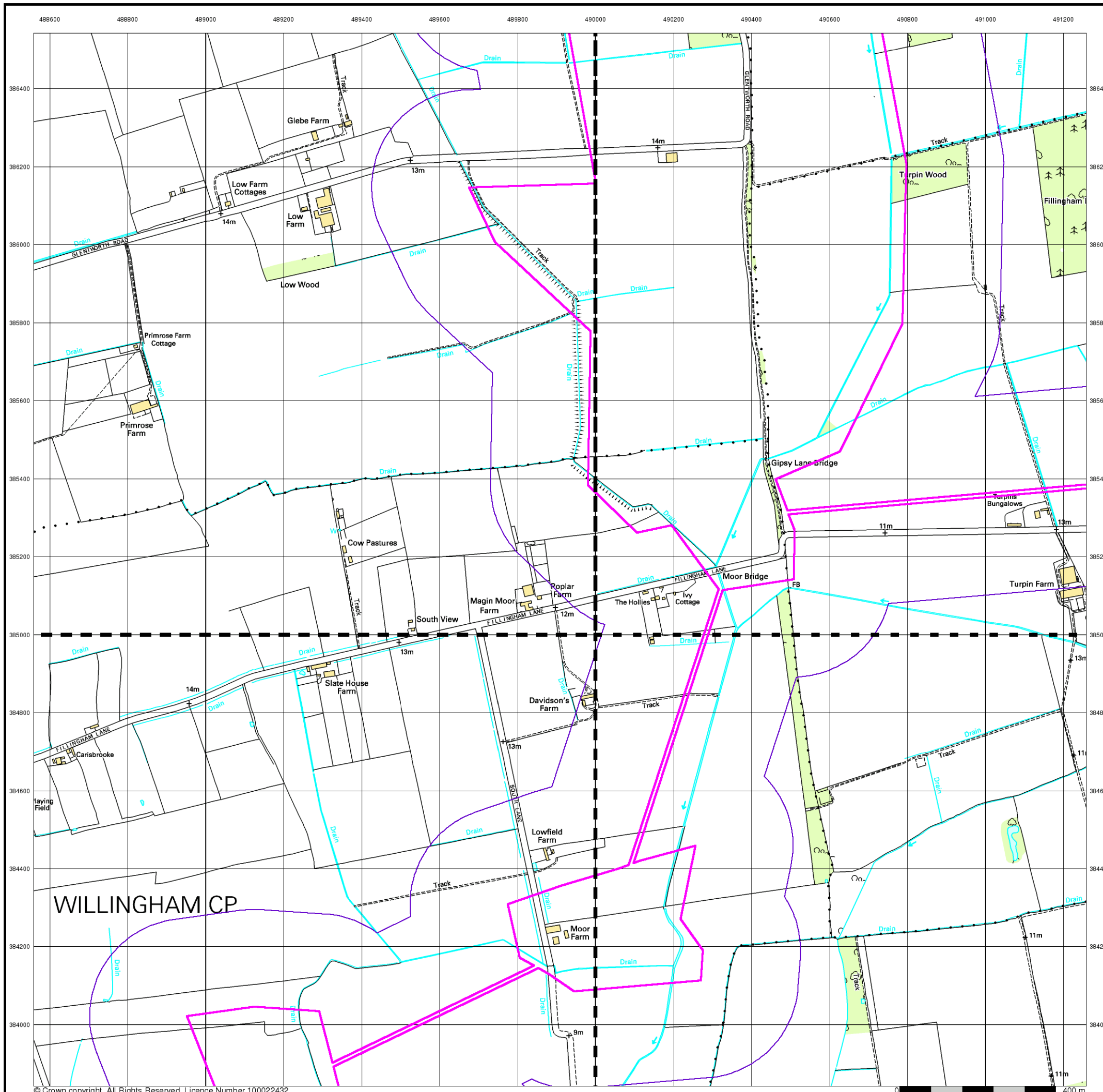

Street View

Published 2022

Source map scale - 1:10,000

Street View is a street-level map for the whole of Great Britain produced by the Ordnance Survey. These maps are provided at a nominal scale of 1:10,000

Map Name(s) and Date(s)



Street View Map - Slice C

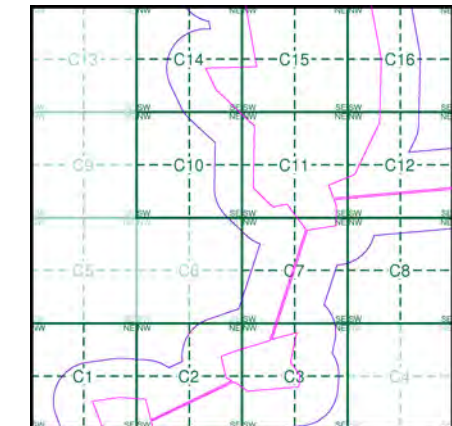

Order Details

Order Number: 297990273_1_1
 Customer Ref: 21-1088.04
 National Grid Reference: 490170, 385250
 Slice: C
 Site Area (Ha): 469.98
 Search Buffer (m): 250

Site Details

Cottam

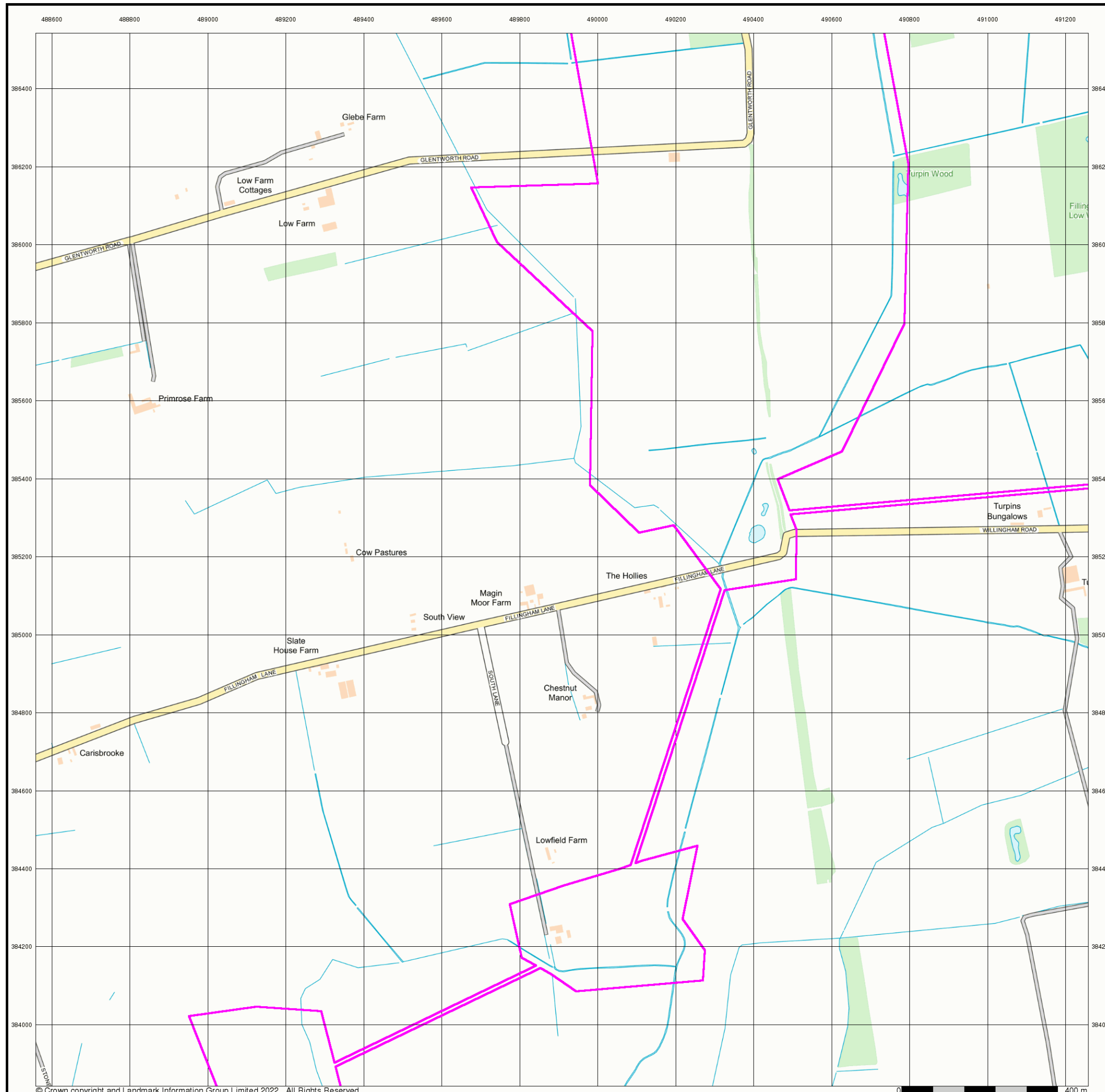

Historical Mapping Legends

Ordnance Survey County Series and Ordnance Survey Plan 1:2,500

Quarry **Gravel Pit** **Sand Pit**
Clay Pit **Shingle** **Refuse Heap**
Sloping Masonry **Flat Rock**
Marsh **Reeds** **Osiers**
Rough Pasture **Furze** **Wood**
Mixed Wood **Brushwood** **Orchard**
Fir **Ford** **Stepping Stones**
Ferry **Waterfall** **Lock**
Trig. Station 507 **Altitude at Trig. Station**
B.M. 325.9 **Bench Mark** 342 **Surface Level**
Arrow denotes flow of water **Antiquities (site of)**
Cutting **Embankment**
Railway crossing Road **Level Crossing** **Road crossing Railway**
Railway crossing River or Canal **Road over single stream** **Road over River or Canal**
County Boundary (Geographical)
County & Civil Parish Boundary
Administrative County & Civil Parish Boundary
County Borough Boundary (England)
Co. Boro. Bdy.
County Burgh Boundary (Scotland)
Co. Burgh Bdy.
BP BS **Boundary Post or Stone** **P.C.B** **Police Call Box**
B.R. **Bridle Road** **P** **Pump**
E.P **Electricity Pylon** **S.P** **Signal Post**
F.B. **Foot Bridge** **SL** **Sluice**
F.P. **Foot Path** **Sp.** **Spring**
G.P **Guide Post or Board** **T.C.B** **Telephone Call Box**
M.S **Mile Stone** **Tr.** **Trough**
M.P M.R **Mooring Post or Ring** **W** **Well**

Ordnance Survey Plan, Additional SIMs and Supply of Unpublished Survey Information 1:2,500 and 1:1,250

Inactive Quarry, Chalk Pit or Clay Pit **Active Quarry, Chalk Pit or Clay Pit**
Rock **Boulders**
Cliff **Slopes** **Top**
Roofed Building **Glazed Roof Building**
Sloping Masonry **Archway**
Non-Coniferous Tree (surveyed) **Coniferous Tree (surveyed)**
Non-Coniferous Trees (not surveyed) **Coniferous Trees (not surveyed)**
Orchard Tree **Scrub** **Bracken**
Coppice, Osier **Reeds** **Marsh, Saltings**
Rough Grassland **Heath** **Culvert**
Direction of water flow **Bench Mark** **Antiquity (site of)**
Cave Entrance **Triangulation Station** **Electricity Pylon**
Electricity Transmission Line
County Boundary (Geographical)
County & Civil Parish Boundary
Civil Parish Boundary
Admin. County or County Bor. Boundary
London Borough Boundary
Symbol marking point where boundary mereing changes
BH **Beer House** **P** **Pillar, Pole or Post**
BP, BS **Boundary Post or Stone** **PO** **Post Office**
Cn, C **Capstan, Crane** **PC** **Public Convenience**
Chy **Chimney** **PH** **Public House**
D Fn **Drinking Fountain** **Pp** **Pump**
EI P **Electricity Pillar or Post** **SB, S Br** **Signal Box or Bridge**
FAP **Fire Alarm Pillar** **SP, SL** **Signal Post or Light**
FB **Foot Bridge** **Spr** **Spring**
GP **Guide Post** **Tk** **Tank or Track**
H **Hydrant or Hydraulic** **TCB** **Telephone Call Box**
LC **Level Crossing** **TCP** **Telephone Call Post**
MH **Manhole** **Tr** **Trough**
MP **Mile Post or Mooring Post** **Wr Pt, Wr T** **Water Point, Water Tap**
MS **Mile Stone** **W** **Well**
NTL **Normal Tidal Limit** **Wd Pp** **Wind Pump**

Large-Scale National Grid Data 1:2,500 and 1:1,250

Cliff **Slopes** **Top**
Rock **Rock (scattered)**
Boulders **Boulders (scattered)**
Positioned Boulder **Scree**
Non-Coniferous Tree (surveyed) **Coniferous Tree (surveyed)**
Non-Coniferous Trees (not surveyed) **Coniferous Trees (not surveyed)**
Orchard Tree **Scrub** **Bracken**
Coppice, Osier **Reeds** **Marsh, Saltings**
Rough Grassland **Heath** **Culvert**
Direction of water flow **Triangulation Station** **Antiquity (site of)**
Electricity Transmission Line **Electricity Pylon**
B.M. 231.60m **Bench Mark** **Buildings with Building Seed**
Roofed Building **Glazed Roof Building**
Civil parish/community boundary
District boundary
County boundary
Boundary post/stone
Boundary mereing symbol (note: these always appear in opposed pairs or groups of three)
Bks **Barracks** **P** **Pillar, Pole or Post**
Bty **Battery** **PO** **Post Office**
Cemy **Cemetery** **PC** **Public Convenience**
Chy **Chimney** **Pp** **Pump**
Cis **Cistern** **Ppg Sta** **Pumping Station**
Dismtd Rly **Dismantled Railway** **PW** **Place of Worship**
EI Gen Sta **Electricity Generating Station** **Sewage Ppg Sta** **Sewage Pumping Station**
EI P **Electricity Pole, Pillar** **SB, S Br** **Signal Box or Bridge**
EI Sub Sta **Electricity Sub Station** **SP, SL** **Signal Post or Light**
FB **Filter Bed** **Spr** **Spring**
Fn / D Fn **Fountain / Drinking Ftn.** **Tk** **Tank or Track**
Gas Gov **Gas Valve Compound** **Tr** **Trough**
GVC **Gas Governor** **Wd Pp** **Wind Pump**
GP **Guide Post** **Wr Pt, Wr T** **Water Point, Water Tap**
MH **Manhole** **Wks** **Works (building or area)**
MP, MS **Mile Post or Mile Stone** **W** **Well**



Historical Mapping & Photography included:

Mapping Type	Scale	Date	Pg
Lincolnshire	1:2,500	1886	2
Lincolnshire	1:2,500	1906	3
Ordnance Survey Plan	1:2,500	1975	4
Large-Scale National Grid Data	1:2,500	1994	5

Historical Map - Segment C1

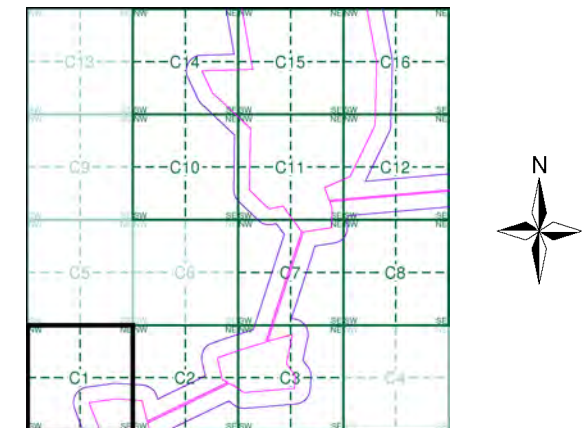

Order Details

Order Number: 297990273_1_1
Customer Ref: 21-1088.04
National Grid Reference: 490170, 385250
Slice: C
Site Area (Ha): 469.98
Search Buffer (m): 100

Site Details

Cottam



Tel: [Redacted]
Fax: [Redacted]
Web: [Redacted]

Lincolnshire
Published 1886

Source map scale - 1:2,500

The historical maps shown were reproduced from maps predominantly held at the scale adopted for England, Wales and Scotland in the 1840's. In 1854 the 1:2,500 scale was adopted for mapping urban areas and by 1896 it covered the whole of what were considered to be the cultivated parts of Great Britain. The published date given below is often some years later than the surveyed date. Before 1938, all OS maps were based on the Cassini Projection, with independent surveys of a single county or group of counties, giving rise to significant inaccuracies in outlying areas.

Map Name(s) and Date(s)

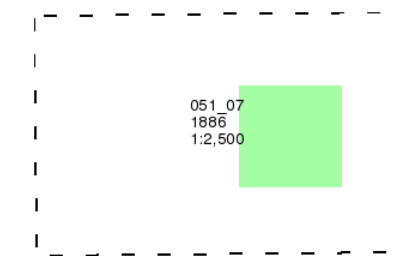

Historical Map - Segment C1

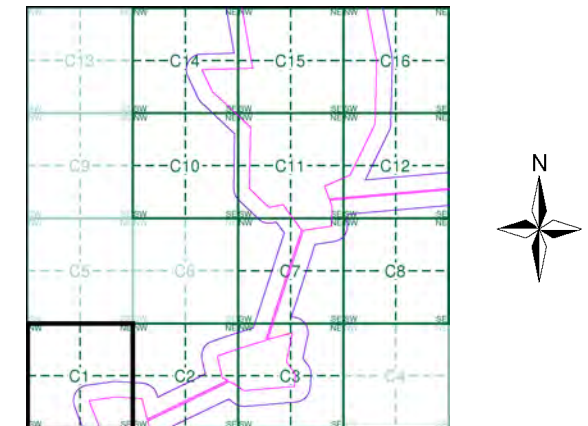

Order Details

Order Number: 297990273_1_1
 Customer Ref: 21-1088.04
 National Grid Reference: 490170, 385250
 Slice: C
 Site Area (Ha): 469.98
 Search Buffer (m): 100

Site Details

Cottam

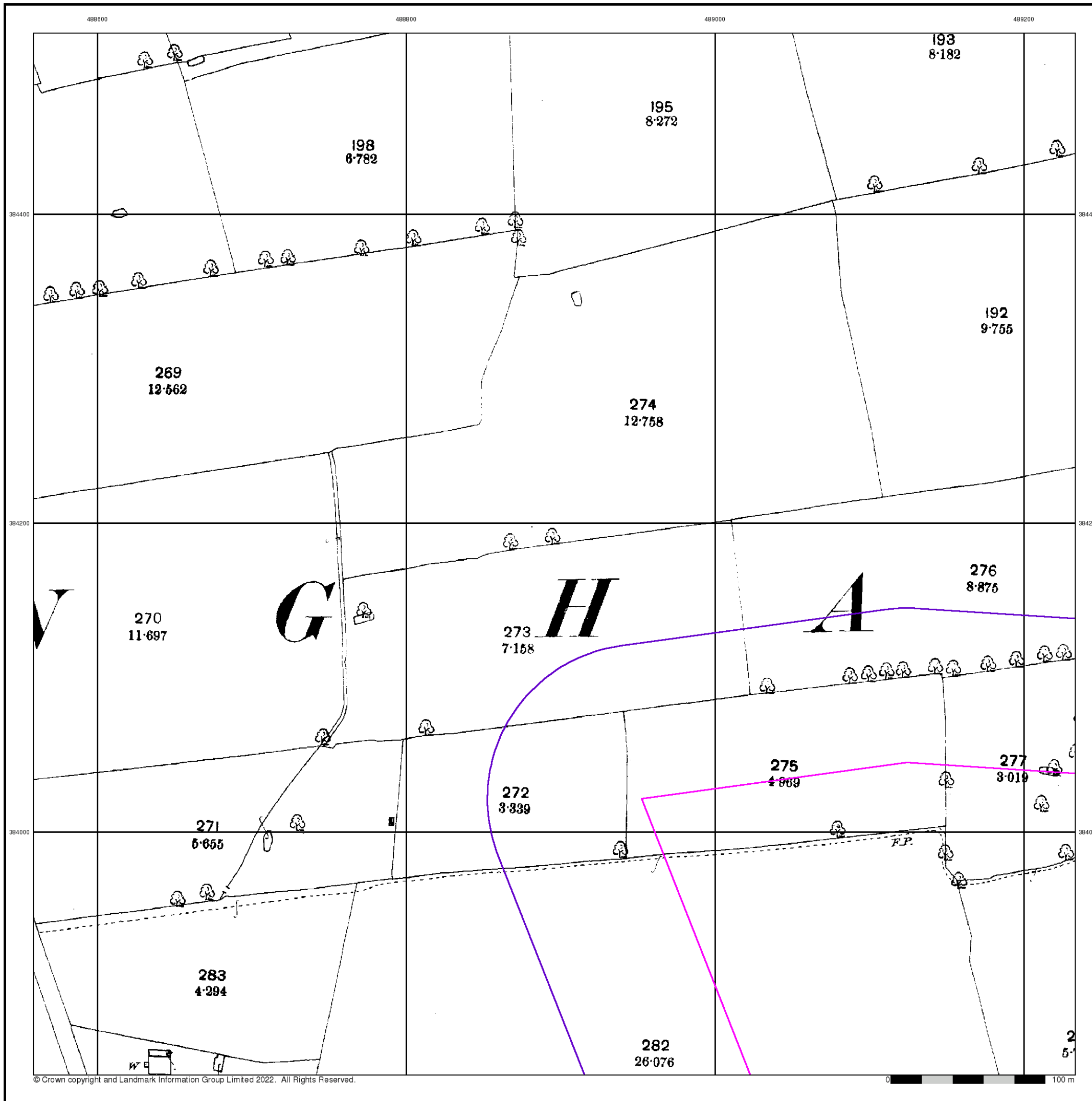

Lincolnshire

Published 1906

Source map scale - 1:2,500

The historical maps shown were reproduced from maps predominantly held at the scale adopted for England, Wales and Scotland in the 1840's. In 1854 the 1:2,500 scale was adopted for mapping urban areas and by 1896 it covered the whole of what were considered to be the cultivated parts of Great Britain. The published date given below is often some years later than the surveyed date. Before 1938, all OS maps were based on the Cassini Projection, with independent surveys of a single county or group of counties, giving rise to significant inaccuracies in outlying areas.

Map Name(s) and Date(s)

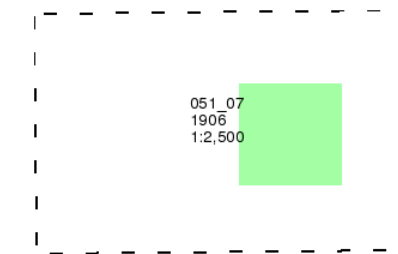

Historical Map - Segment C1

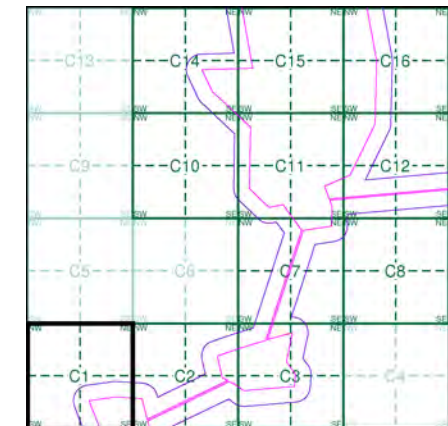

Order Details

Order Number: 297990273_1_1
 Customer Ref: 21-1088.04
 National Grid Reference: 490170, 385250
 Slice: C
 Site Area (Ha): 469.98
 Search Buffer (m): 100

Site Details

Cottam

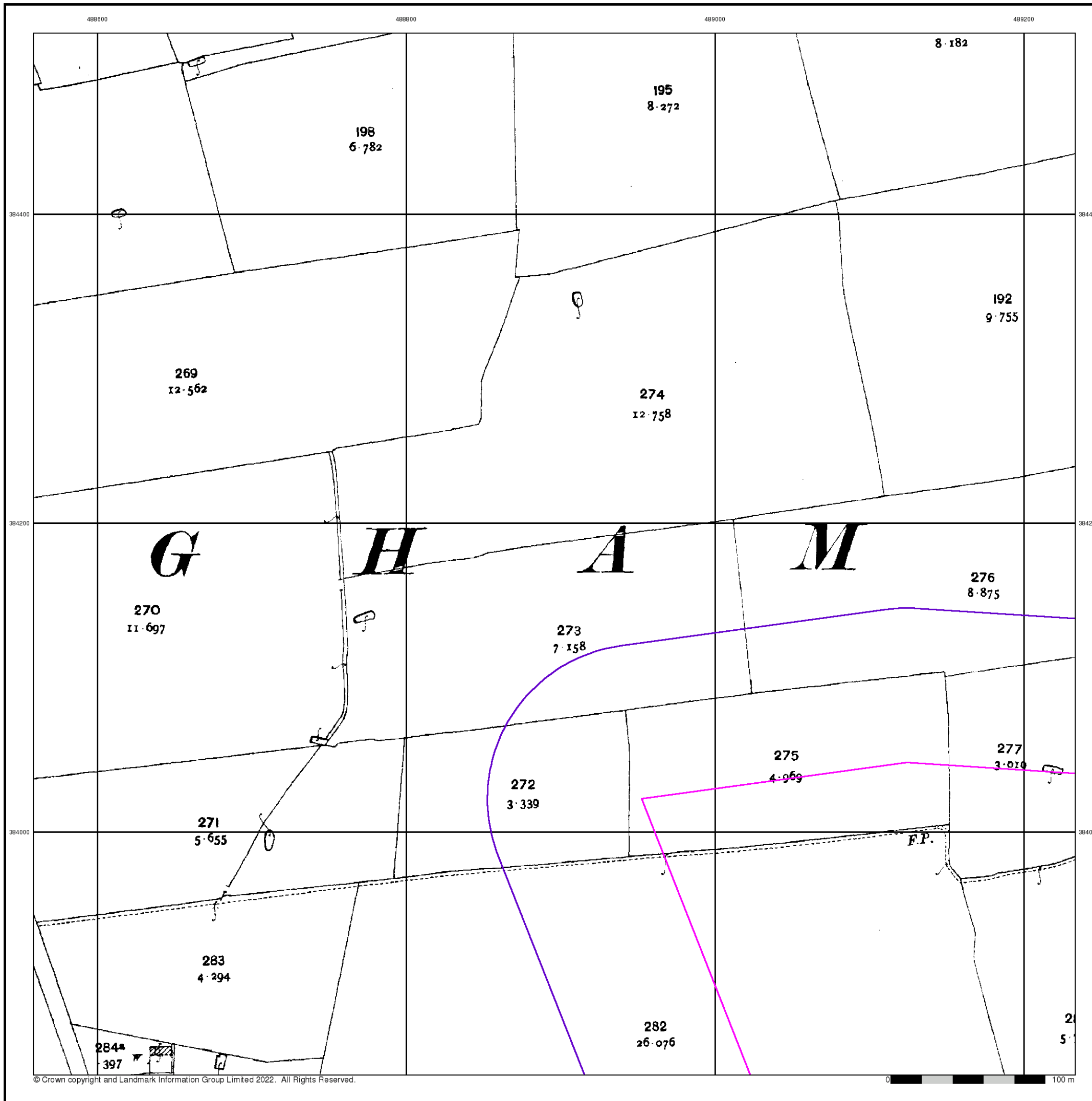

Ordnance Survey Plan

Published 1975

Source map scale - 1:2,500

The historical maps shown were reproduced from maps predominantly held at the scale adopted for England, Wales and Scotland in the 1840's. In 1854 the 1:2,500 scale was adopted for mapping urban areas and by 1896 it covered the whole of what were considered to be the cultivated parts of Great Britain. The published date given below is often some years later than the surveyed date. Before 1938, all OS maps were based on the Cassini Projection, with independent surveys of a single county or group of counties, giving rise to significant inaccuracies in outlying areas.

Map Name(s) and Date(s)

SK8884 1975 1:2,500	SK8984 1975 1:2,500
SK8883 1975 1:2,500	SK8983 1975 1:2,500

Historical Map - Segment C1

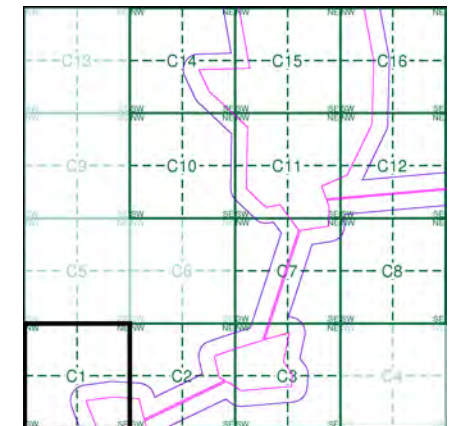

Order Details

Order Number: 297990273_1_1
 Customer Ref: 21-1088.04
 National Grid Reference: 490170, 385250
 Slice: C
 Site Area (Ha): 469.98
 Search Buffer (m): 100

Site Details

Cottam



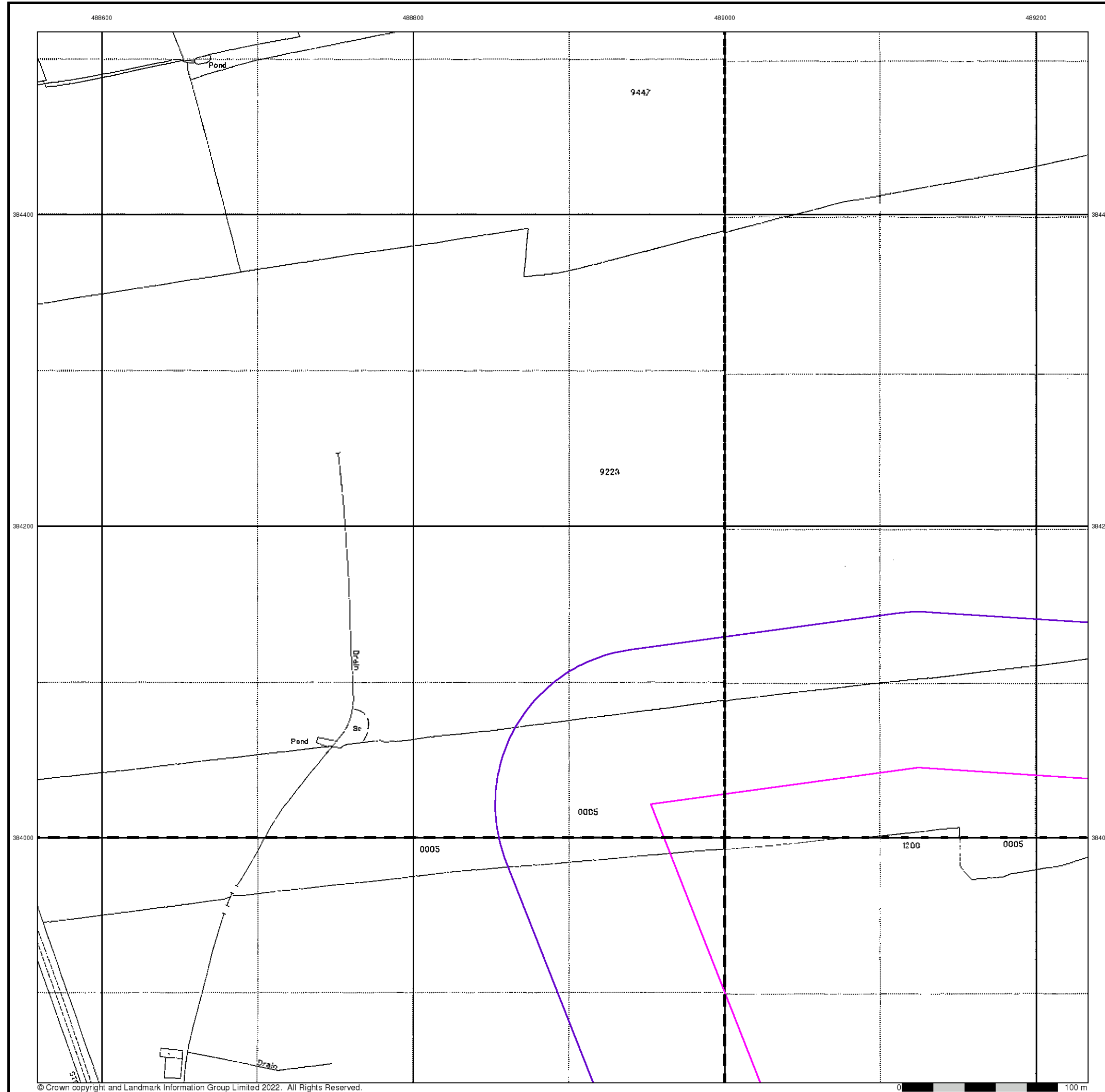

© Crown copyright and Landmark Information Group Limited 2022. All Rights Reserved.



Large-Scale National Grid Data

Published 1994

Source map scale - 1:2,500

'Large Scale National Grid Data' superseded SIM cards (Ordnance Survey's 'Survey of Information on Microfilm') in 1992, and continued to be produced until 1999. These maps were the fore-runners of digital mapping and so provide detailed information on houses and roads, but tend to show less topographic features such as vegetation. These maps were produced at both 1:2,500 and 1:1,250 scales.

Map Name(s) and Date(s)

SK8884 1994 1:2,500	SK8984 1994 1:2,500
SK8883 1994 1:2,500	SK8983 1994 1:2,500

Historical Map - Segment C1

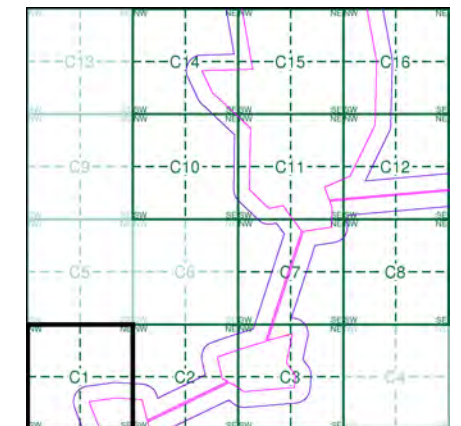

Order Details

Order Number: 297990273_1_1
 Customer Ref: 21-1088.04
 National Grid Reference: 490170, 385250
 Slice: C
 Site Area (Ha): 469.98
 Search Buffer (m): 100

Site Details

Cottam



Tel: [Redacted]
 Fax: [Redacted]
 Web: [Redacted]

Historical Mapping Legends

Ordnance Survey County Series and Ordnance Survey Plan 1:2,500

Quarry **Gravel Pit** **Sand Pit**
Clay Pit **Shingle** **Refuse Heap**
Sloping Masonry **Flat Rock**
Marsh **Reeds** **Osiers**
Rough Pasture **Furze** **Wood**
Mixed Wood **Brushwood** **Orchard**
Fir **Ford** **Stepping Stones**
Ferry **Waterfall** **Lock**
Trig. Station **Altitude at Trig. Station**
B.M. 325.9 **Bench Mark** **Surface Level**
Arrow denotes flow of water **Antiquities (site of)**
Cutting **Embankment**
Railway crossing Road **Level Crossing** **Road crossing Railway**
Railway crossing River or Canal **Road over single stream** **Road over River or Canal**
County Boundary (Geographical)
County & Civil Parish Boundary
Administrative County & Civil Parish Boundary
County Borough Boundary (England)
County Burgh Boundary (Scotland)
Co. Boro. Bdy.
Co. Burgh Bdy.
BP BS Boundary Post or Stone **P.C.B** Police Call Box
B.R. Bridle Road **P** Pump
E.P Electricity Pylon **S.P** Signal Post
F.B. Foot Bridge **SL** Sluice
F.P. Foot Path **Sp.** Spring
G.P Guide Post or Board **T.C.B** Telephone Call Box
M.S Mile Stone **Tr.** Trough
M.P M.R Mooring Post or Ring **W** Well

Ordnance Survey Plan, Additional SIMs and Supply of Unpublished Survey Information 1:2,500 and 1:1,250

Inactive Quarry, Chalk Pit or Clay Pit **Active Quarry, Chalk Pit or Clay Pit**
Rock **Boulders**
Cliff **Slopes** **Top**
Roofed Building **Glazed Roof Building**
Sloping Masonry **Archway**
Non-Coniferous Tree (surveyed) **Coniferous Tree (surveyed)**
Non-Coniferous Trees (not surveyed) **Coniferous Trees (not surveyed)**
Orchard Tree **Scrub** **Bracken**
Coppice, Osier **Reeds** **Marsh, Saltings**
Rough Grassland **Heath** **Culvert**
Direction of water flow **Bench Mark** **Antiquity (site of)**
Cave Entrance **Triangulation Station** **Electricity Pylon**
Electricity Transmission Line
County Boundary (Geographical)
County & Civil Parish Boundary
Civil Parish Boundary
Admin. County or County Bor. Boundary
London Borough Boundary
Symbol marking point where boundary mereing changes
BH Beer House **P** Pillar, Pole or Post
BP, BS Boundary Post or Stone **PO** Post Office
Cn, C Capstan, Crane **PC** Public Convenience
Chy Chimney **PH** Public House
D Fn Drinking Fountain **Pp** Pump
EI P Electricity Pillar or Post **SB, S Br** Signal Box or Bridge
FAP Fire Alarm Pillar **SP, SL** Signal Post or Light
FB Foot Bridge **Spr** Spring
GP Guide Post **Tk** Tank or Track
H Hydrant or Hydraulic **TCB** Telephone Call Box
LC Level Crossing **TCP** Telephone Call Post
MH Manhole **Tr** Trough
MP Mile Post or Mooring Post **Wr Pt, Wr T** Water Point, Water Tap
MS Mile Stone **W** Well
NTL Normal Tidal Limit **Wd Pp** Wind Pump

Large-Scale National Grid Data 1:2,500 and 1:1,250

Cliff **Slopes** **Top**
Rock **Rock (scattered)**
Boulders **Boulders (scattered)**
Positioned Boulder **Scree**
Non-Coniferous Tree (surveyed) **Coniferous Tree (surveyed)**
Non-Coniferous Trees (not surveyed) **Coniferous Trees (not surveyed)**
Orchard Tree **Scrub** **Bracken**
Coppice, Osier **Reeds** **Marsh, Saltings**
Rough Grassland **Heath** **Culvert**
Direction of water flow **Triangulation Station** **Antiquity (site of)**
Electricity Transmission Line **Electricity Pylon**
B.M. 231.60m Bench Mark **Buildings with Building Seed**
Roofed Building **Glazed Roof Building**
Civil parish/community boundary
District boundary
County boundary
Boundary post/stone
Boundary mereing symbol (note: these always appear in opposed pairs or groups of three)
Bks Barracks **P** Pillar, Pole or Post
Bty Battery **PO** Post Office
Cemy Cemetery **PC** Public Convenience
Chy Chimney **Pp** Pump
Cis Cistern **Ppg Sta** Pumping Station
Dismtd Rly Dismantled Railway **PW** Place of Worship
EI Gen Sta Electricity Generating Station **Sewage Ppg Sta** Sewage Pumping Station
EI P Electricity Pole, Pillar **SB, S Br** Signal Box or Bridge
EI Sub Sta Electricity Sub Station **SP, SL** Signal Post or Light
FB Filter Bed **Spr** Spring
Fn / D Fn Fountain / Drinking Ftn. **Tk** Tank or Track
Gas Gov Gas Valve Compound **Tr** Trough
GVC Gas Governor **Wd Pp** Wind Pump
GP Guide Post **Wr Pt, Wr T** Water Point, Water Tap
MH Manhole **Wks** Works (building or area)
MP, MS Mile Post or Mile Stone **W** Well



Historical Mapping & Photography included:

Mapping Type	Scale	Date	Pg
Lincolnshire	1:2,500	1886	2
Lincolnshire	1:2,500	1906	3
Ordnance Survey Plan	1:2,500	1975	4
Large-Scale National Grid Data	1:2,500	1994	5

Historical Map - Segment C2

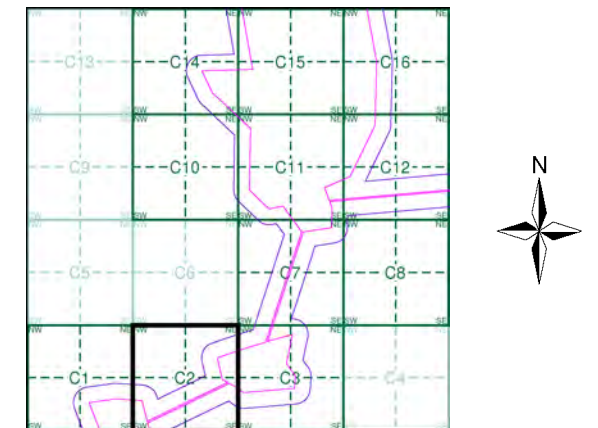

Order Details

Order Number: 297990273_1_1
 Customer Ref: 21-1088.04
 National Grid Reference: 490170, 385250
 Slice: C
 Site Area (Ha): 469.98
 Search Buffer (m): 100

Site Details

Cottam



Tel: [Redacted]
 Fax: [Redacted]
 Web: [Redacted]

Lincolnshire

Published 1886

Source map scale - 1:2,500

The historical maps shown were reproduced from maps predominantly held at the scale adopted for England, Wales and Scotland in the 1840's. In 1854 the 1:2,500 scale was adopted for mapping urban areas and by 1896 it covered the whole of what were considered to be the cultivated parts of Great Britain. The published date given below is often some years later than the surveyed date. Before 1938, all OS maps were based on the Cassini Projection, with independent surveys of a single county or group of counties, giving rise to significant inaccuracies in outlying areas.

Map Name(s) and Date(s)

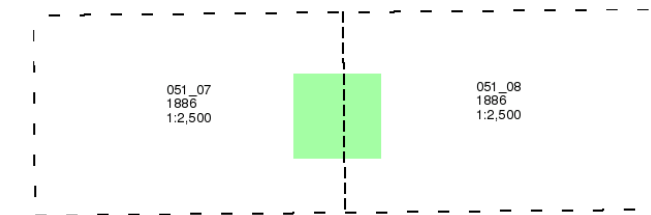

Historical Map - Segment C2

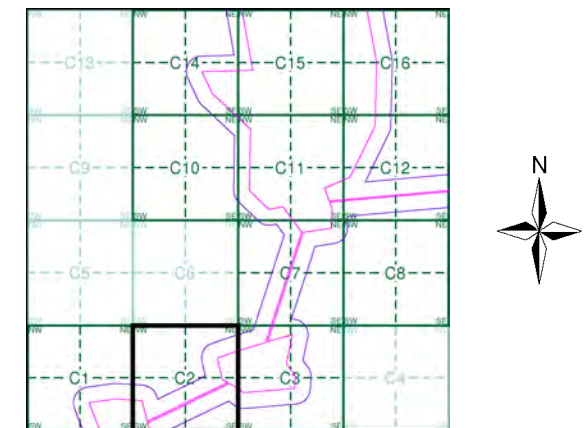

Order Details

Order Number: 297990273_1_1
 Customer Ref: 21-1088.04
 National Grid Reference: 490170, 385250
 Slice: C
 Site Area (Ha): 469.98
 Search Buffer (m): 100

Site Details

Cottam

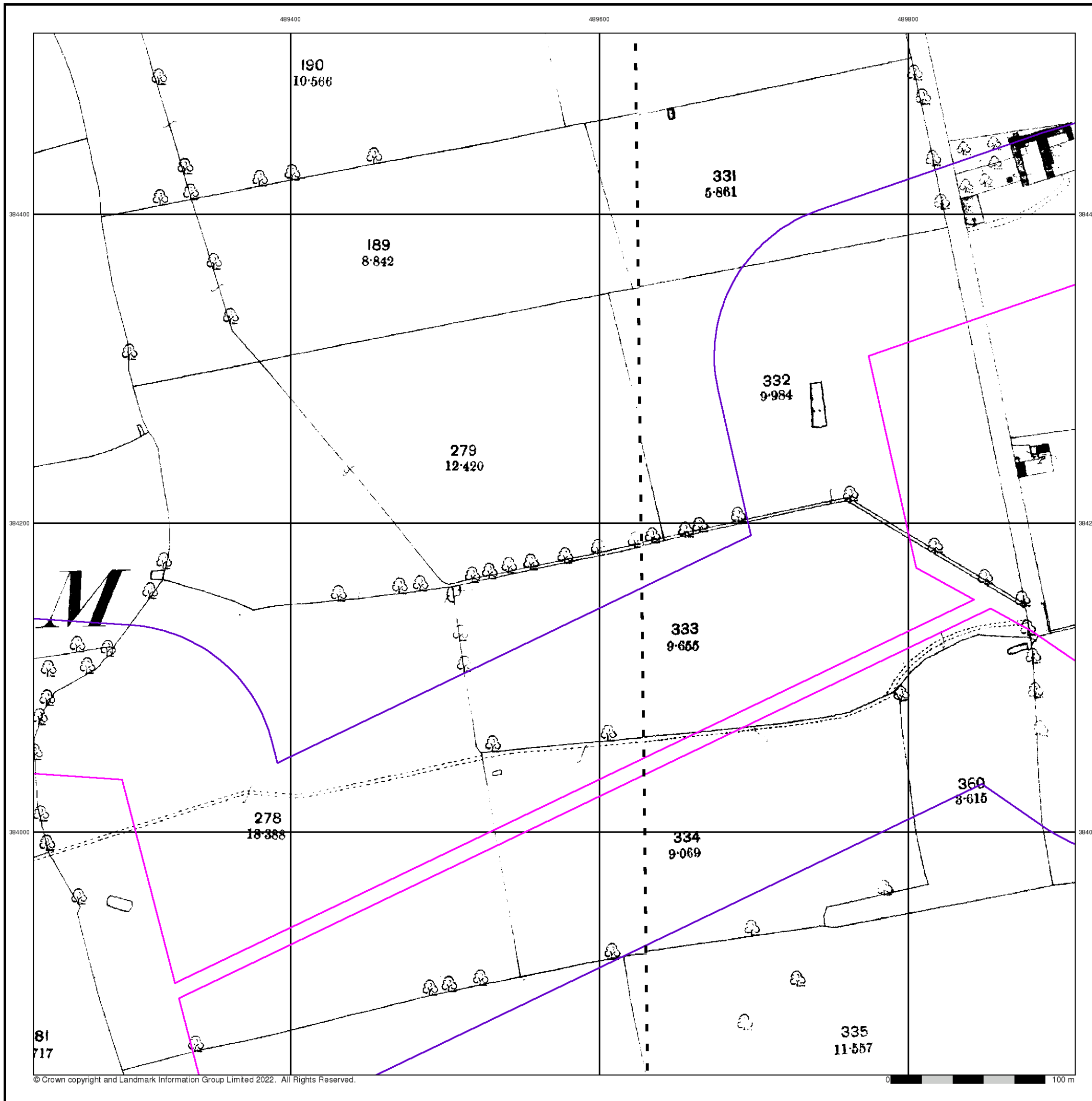

Lincolnshire

Published 1906

Source map scale - 1:2,500

The historical maps shown were reproduced from maps predominantly held at the scale adopted for England, Wales and Scotland in the 1840's. In 1854 the 1:2,500 scale was adopted for mapping urban areas and by 1896 it covered the whole of what were considered to be the cultivated parts of Great Britain. The published date given below is often some years later than the surveyed date. Before 1938, all OS maps were based on the Cassini Projection, with independent surveys of a single county or group of counties, giving rise to significant inaccuracies in outlying areas.

Map Name(s) and Date(s)

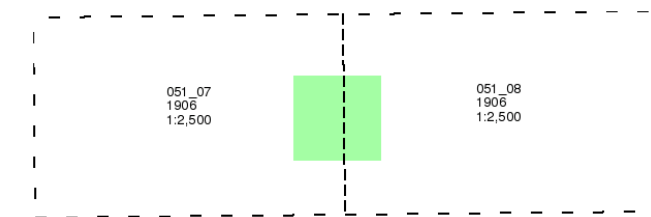

Historical Map - Segment C2

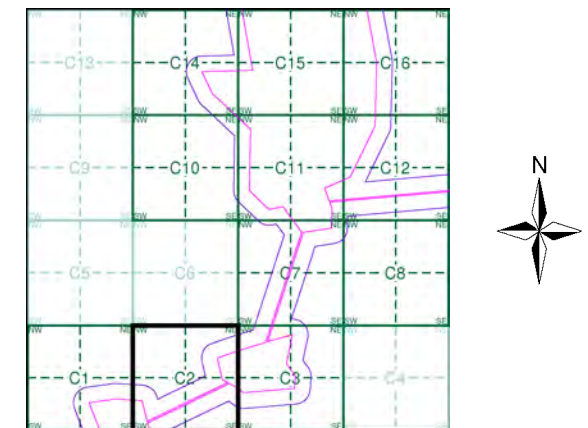

Order Details

Order Number: 297990273_1_1
 Customer Ref: 21-1088.04
 National Grid Reference: 490170, 385250
 Slice: C
 Site Area (Ha): 469.98
 Search Buffer (m): 100

Site Details

Cottam

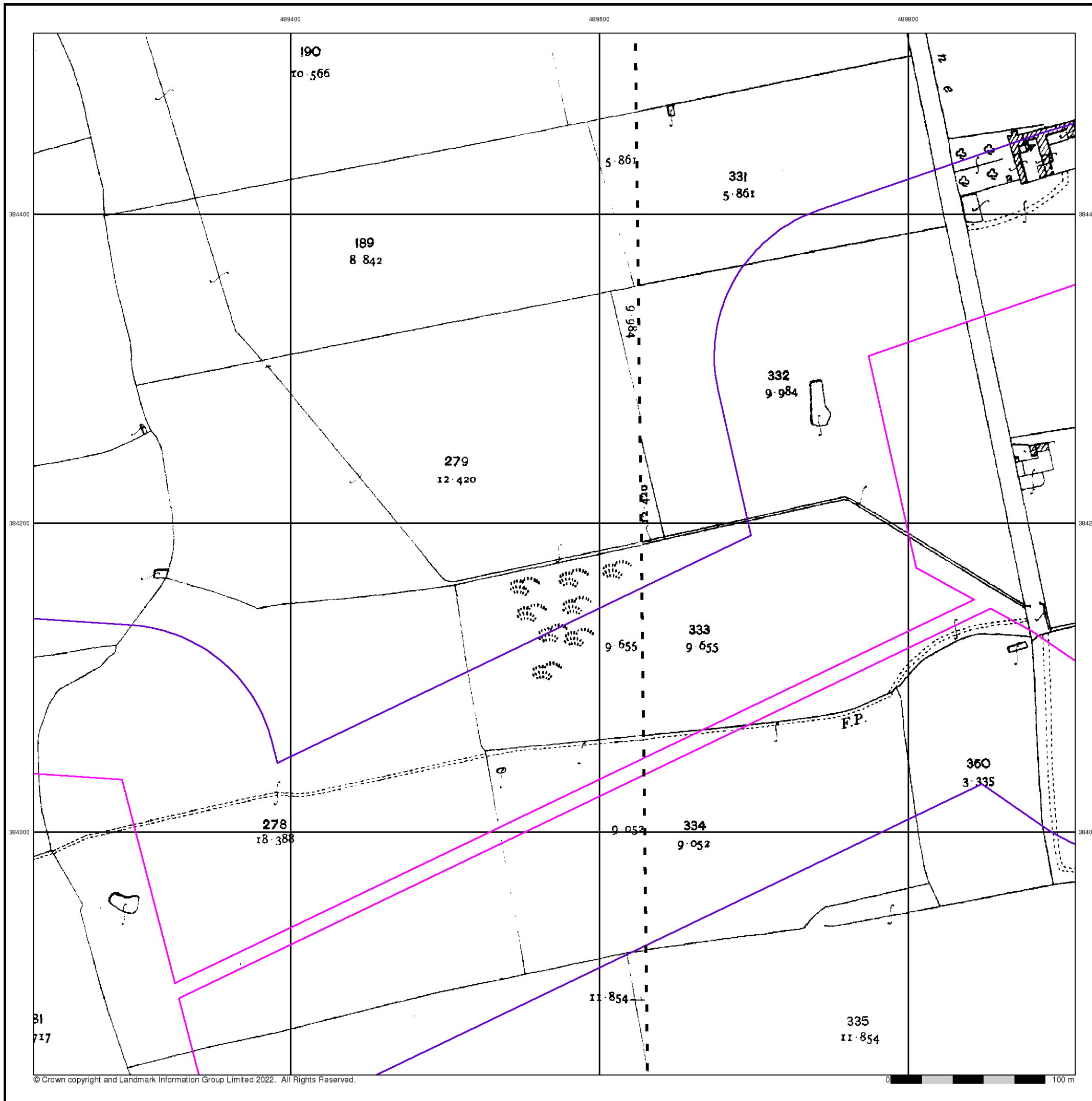

Ordnance Survey Plan
Published 1975
Source map scale - 1:2,500

The historical maps shown were reproduced from maps predominantly held at the scale adopted for England, Wales and Scotland in the 1840's. In 1854 the 1:2,500 scale was adopted for mapping urban areas and by 1896 it covered the whole of what were considered to be the cultivated parts of Great Britain. The published date given below is often some years later than the surveyed date. Before 1938, all OS maps were based on the Cassini Projection, with independent surveys of a single county or group of counties, giving rise to significant inaccuracies in outlying areas.

Map Name(s) and Date(s)

SK8984	1975	1:2,500
SK8983	1975	1:2,500

Historical Map - Segment C2

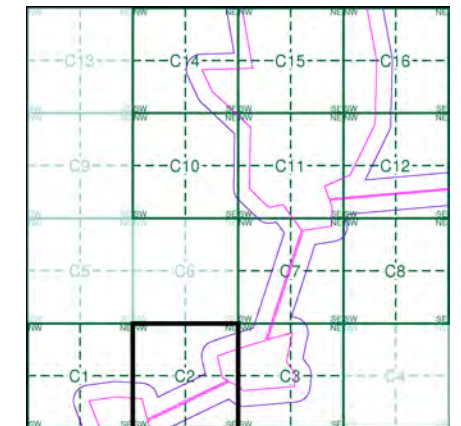

Order Details

Order Number: 297990273_1_1
 Customer Ref: 21-1088.04
 National Grid Reference: 490170, 385250
 Slice: C
 Site Area (Ha): 469.98
 Search Buffer (m): 100

Site Details

Cottam

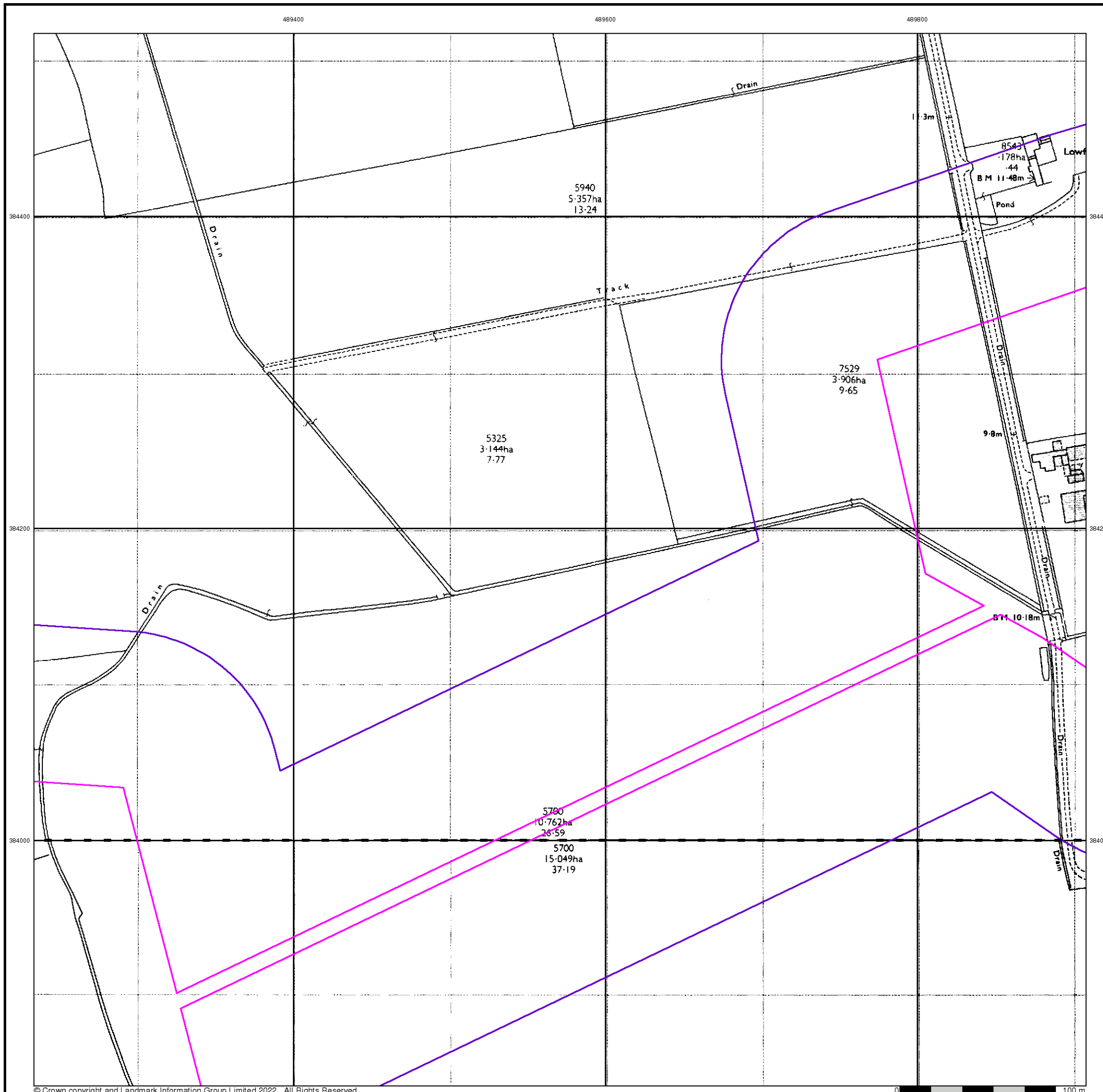

Large-Scale National Grid Data
Published 1994
Source map scale - 1:2,500

'Large Scale National Grid Data' superseded SIM cards (Ordnance Survey's 'Survey of Information on Microfilm') in 1992, and continued to be produced until 1999. These maps were the fore-runners of digital mapping and so provide detailed information on houses and roads, but tend to show less topographic features such as vegetation. These maps were produced at both 1:2,500 and 1:1,250 scales.

Map Name(s) and Date(s)

SK8984	1994	1:2,500
SK8983	1994	1:2,500

Historical Map - Segment C2

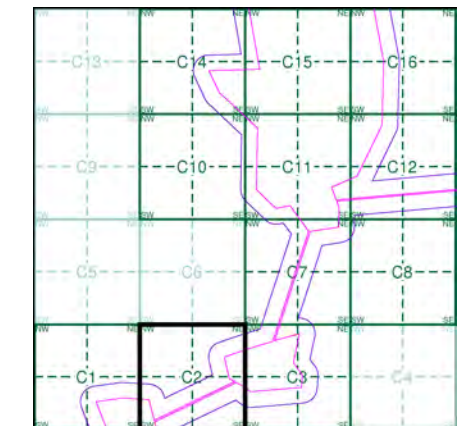

Order Details

Order Number: 297990273_1_1
 Customer Ref: 21-1088.04
 National Grid Reference: 490170, 385250
 Slice: C
 Site Area (Ha): 469.98
 Search Buffer (m): 100

Site Details

Cottam



Historical Mapping Legends

Ordnance Survey County Series and Ordnance Survey Plan 1:2,500

Quarry **Gravel Pit** **Sand Pit**
Clay Pit **Shingle** **Refuse Heap**
Sloping Masonry **Flat Rock**
Marsh **Reeds** **Osiers**
Rough Pasture **Furze** **Wood**
Mixed Wood **Brushwood** **Orchard**
Fir **Ford** **Stepping Stones**
Ferry **Waterfall** **Lock**
Trig. Station **Altitude at Trig. Station**
B.M. 325.9 **Bench Mark** **Surface Level**
Arrow denotes flow of water **Antiquities (site of)**
Cutting **Embankment**
Railway crossing Road **Level Crossing** **Road crossing Railway**
Railway crossing River or Canal **Road over single stream** **Road over River or Canal**
County Boundary (Geographical)
County & Civil Parish Boundary
Administrative County & Civil Parish Boundary
County Borough Boundary (England)
Co. Boro. Bdy.
County Burgh Boundary (Scotland)
Co. Burgh Bdy.
BP BS Boundary Post or Stone **P.C.B** Police Call Box
B.R. Bridle Road **P** Pump
E.P Electricity Pylon **S.P** Signal Post
F.B. Foot Bridge **SL** Sluice
F.P. Foot Path **Sp.** Spring
G.P Guide Post or Board **T.C.B** Telephone Call Box
M.S Mile Stone **Tr.** Trough
M.P M.R Mooring Post or Ring **W** Well

Ordnance Survey Plan, Additional SIMs and Supply of Unpublished Survey Information 1:2,500 and 1:1,250

Inactive Quarry, Chalk Pit or Clay Pit **Active Quarry, Chalk Pit or Clay Pit**
Rock **Boulders**
Cliff **Slopes** **Top**
Roofed Building **Glazed Roof Building**
Sloping Masonry **Archway**
Non-Coniferous Tree (surveyed) **Coniferous Tree (surveyed)**
Non-Coniferous Trees (not surveyed) **Coniferous Trees (not surveyed)**
Orchard Tree **Scrub** **Bracken**
Coppice, Osier **Reeds** **Marsh, Saltings**
Rough Grassland **Heath** **Culvert**
Direction of water flow **Bench Mark** **Antiquity (site of)**
Cave Entrance **Triangulation Station** **Electricity Pylon**
Electricity Transmission Line
County Boundary (Geographical)
County & Civil Parish Boundary
Civil Parish Boundary
Admin. County or County Bor. Boundary
London Borough Boundary
Symbol marking point where boundary mereing changes
BH Beer House **P** Pillar, Pole or Post
BP, BS Boundary Post or Stone **PO** Post Office
Cn, C Capstan, Crane **PC** Public Convenience
Chy Chimney **PH** Public House
D Fn Drinking Fountain **Pp** Pump
EI P Electricity Pillar or Post **SB, S Br** Signal Box or Bridge
FAP Fire Alarm Pillar **SP, SL** Signal Post or Light
FB Foot Bridge **Spr** Spring
GP Guide Post **Tk** Tank or Track
H Hydrant or Hydraulic **TCB** Telephone Call Box
LC Level Crossing **TCP** Telephone Call Post
MH Manhole **Tr** Trough
MP Mile Post or Mooring Post **Wr Pt, Wr T** Water Point, Water Tap
MS Mile Stone **W** Well
NTL Normal Tidal Limit **Wd Pp** Wind Pump

Large-Scale National Grid Data 1:2,500 and 1:1,250

Cliff **Slopes** **Top**
Rock **Rock (scattered)**
Boulders **Boulders (scattered)**
Positioned Boulder **Scree**
Non-Coniferous Tree (surveyed) **Coniferous Tree (surveyed)**
Non-Coniferous Trees (not surveyed) **Coniferous Trees (not surveyed)**
Orchard Tree **Scrub** **Bracken**
Coppice, Osier **Reeds** **Marsh, Saltings**
Rough Grassland **Heath** **Culvert**
Direction of water flow **Triangulation Station** **Antiquity (site of)**
Electricity Transmission Line **Electricity Pylon**
B.M. 231.60m Bench Mark **Buildings with Building Seed**
Roofed Building **Glazed Roof Building**
Civil parish/community boundary
District boundary
County boundary
Boundary post/stone
Boundary mereing symbol (note: these always appear in opposed pairs or groups of three)
Bks Barracks **P** Pillar, Pole or Post
Bty Battery **PO** Post Office
Cemy Cemetery **PC** Public Convenience
Chy Chimney **Pp** Pump
Cis Cistern **Ppg Sta** Pumping Station
Dismtd Rly Dismantled Railway **PW** Place of Worship
EI Gen Sta Electricity Generating Station **Sewage Ppg Sta** Sewage Pumping Station
EI P Electricity Pole, Pillar **SB, S Br** Signal Box or Bridge
EI Sub Sta Electricity Sub Station **SP, SL** Signal Post or Light
FB Filter Bed **Spr** Spring
Fn / D Fn Fountain / Drinking Ftn. **Tk** Tank or Track
Gas Gov Gas Valve Compound **Tr** Trough
GVC Gas Governor **Wd Pp** Wind Pump
GP Guide Post **Wr Pt, Wr T** Water Point, Water Tap
MH Manhole **Wks** Works (building or area)
MP, MS Mile Post or Mile Stone **W** Well



Historical Mapping & Photography included:

Mapping Type	Scale	Date	Pg
Lincolnshire	1:2,500	1886	2
Lincolnshire	1:2,500	1906	3
Ordnance Survey Plan	1:2,500	1974 - 1975	4
Large-Scale National Grid Data	1:2,500	1994	5

Historical Map - Segment C3

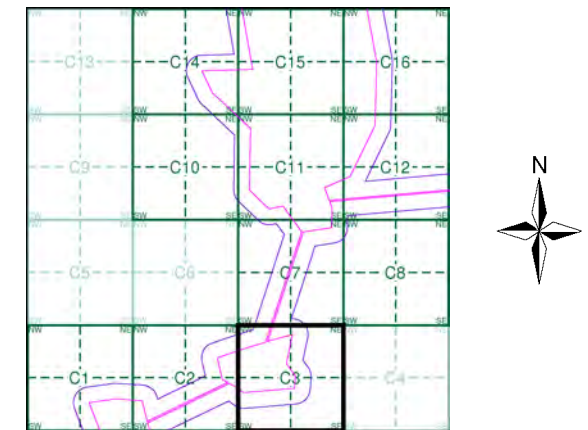

Order Details

Order Number: 297990273_1_1
 Customer Ref: 21-1088.04
 National Grid Reference: 490170, 385250
 Slice: C
 Site Area (Ha): 469.98
 Search Buffer (m): 100

Site Details

Cottam



Tel:
Fax:
Web:

Lincolnshire
Published 1886

Source map scale - 1:2,500

The historical maps shown were reproduced from maps predominantly held at the scale adopted for England, Wales and Scotland in the 1840's. In 1854 the 1:2,500 scale was adopted for mapping urban areas and by 1896 it covered the whole of what were considered to be the cultivated parts of Great Britain. The published date given below is often some years later than the surveyed date. Before 1938, all OS maps were based on the Cassini Projection, with independent surveys of a single county or group of counties, giving rise to significant inaccuracies in outlying areas.

Map Name(s) and Date(s)

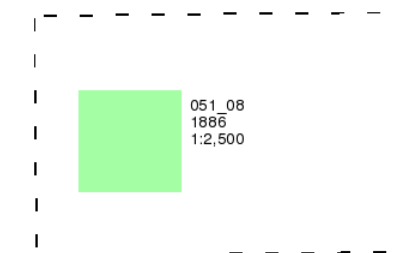

Historical Map - Segment C3

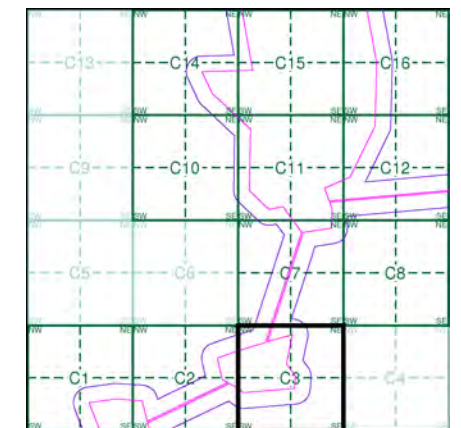

Order Details

Order Number: 297990273_1_1
 Customer Ref: 21-1088.04
 National Grid Reference: 490170, 385250
 Slice: C
 Site Area (Ha): 469.98
 Search Buffer (m): 100

Site Details

Cottam

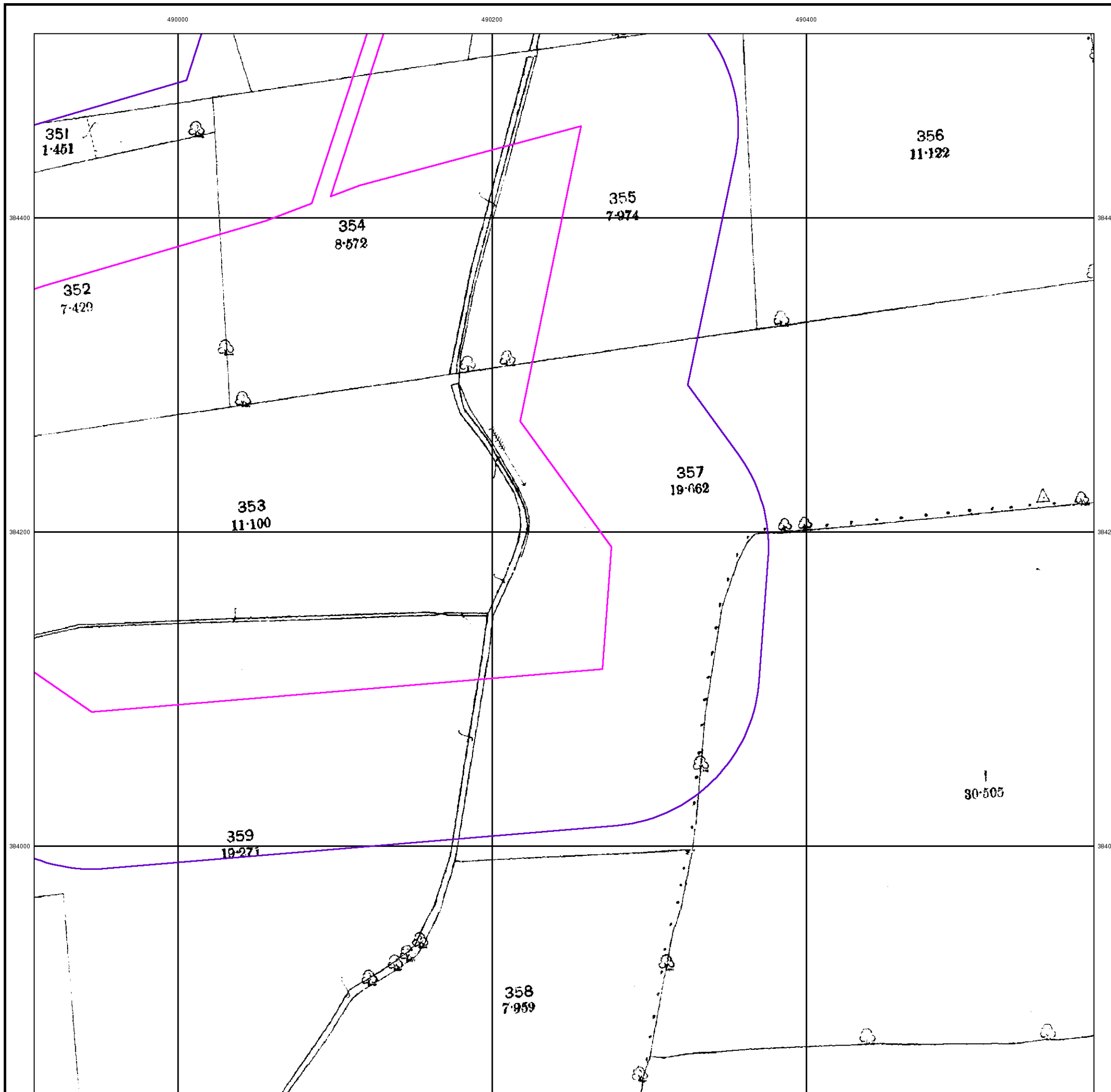

Lincolnshire
Published 1906

Source map scale - 1:2,500

The historical maps shown were reproduced from maps predominantly held at the scale adopted for England, Wales and Scotland in the 1840's. In 1854 the 1:2,500 scale was adopted for mapping urban areas and by 1896 it covered the whole of what were considered to be the cultivated parts of Great Britain. The published date given below is often some years later than the surveyed date. Before 1938, all OS maps were based on the Cassini Projection, with independent surveys of a single county or group of counties, giving rise to significant inaccuracies in outlying areas.

Map Name(s) and Date(s)

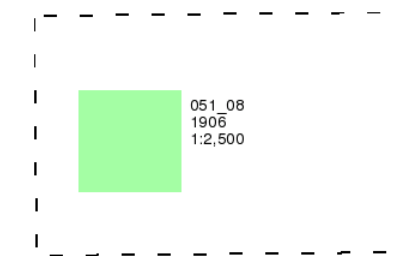

Historical Map - Segment C3

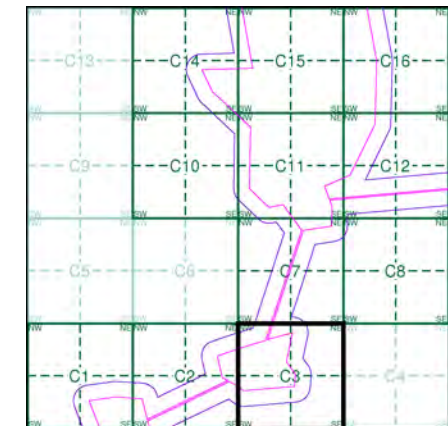

Order Details

Order Number: 297990273_1_1
 Customer Ref: 21-1088.04
 National Grid Reference: 490170, 385250
 Slice: C
 Site Area (Ha): 469.98
 Search Buffer (m): 100

Site Details

Cottam

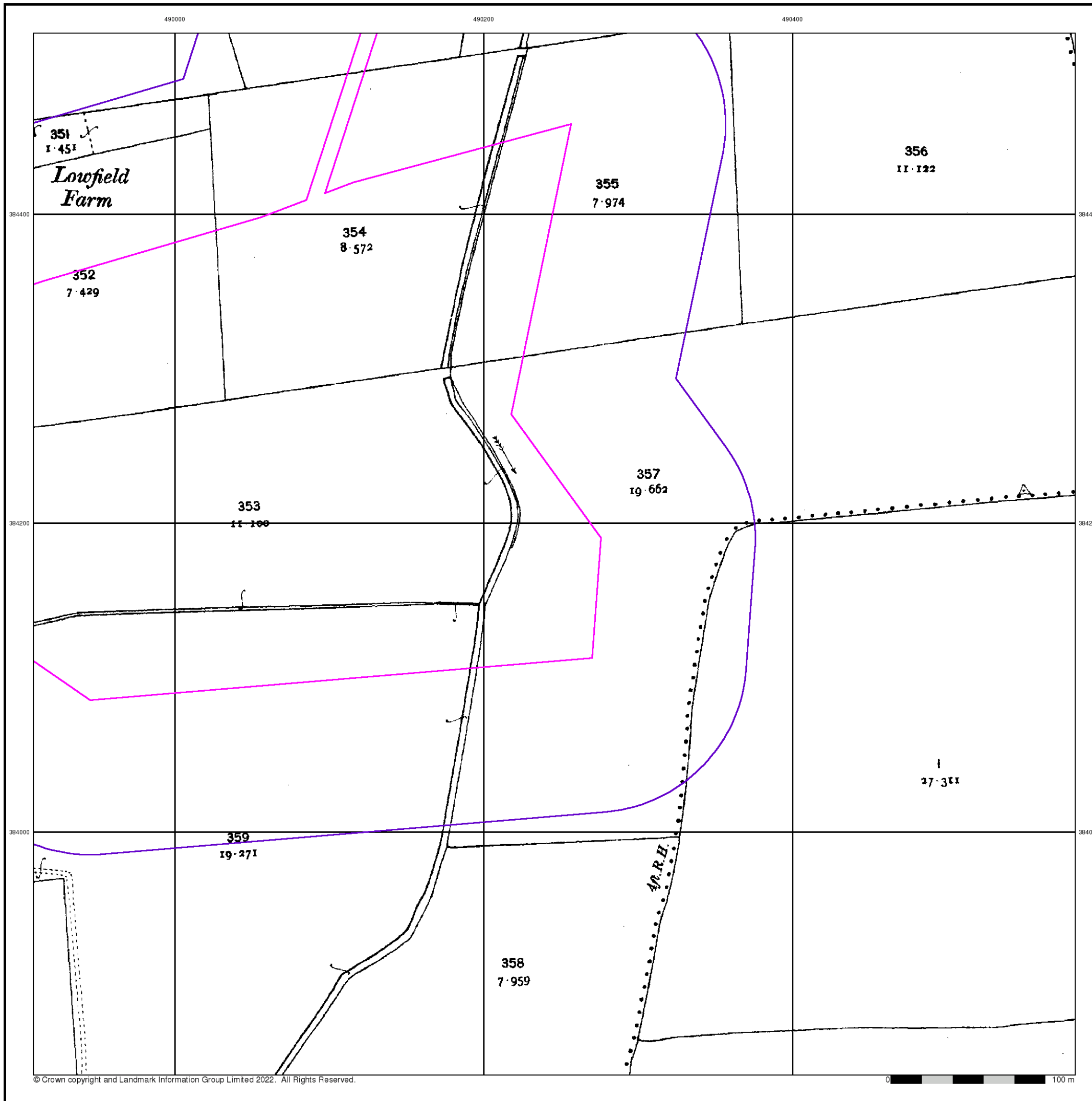

Ordnance Survey Plan
Published 1974 - 1975
Source map scale - 1:2,500

The historical maps shown were reproduced from maps predominantly held at the scale adopted for England, Wales and Scotland in the 1840's. In 1854 the 1:2,500 scale was adopted for mapping urban areas and by 1896 it covered the whole of what were considered to be the cultivated parts of Great Britain. The published date given below is often some years later than the surveyed date. Before 1938, all OS maps were based on the Cassini Projection, with independent surveys of a single county or group of counties, giving rise to significant inaccuracies in outlying areas.

Map Name(s) and Date(s)

SK8984 1975 1:2,500	SK9084 1974 1:2,500
SK8983 1975 1:2,500	SK9083 1974 1:2,500

Historical Map - Segment C3

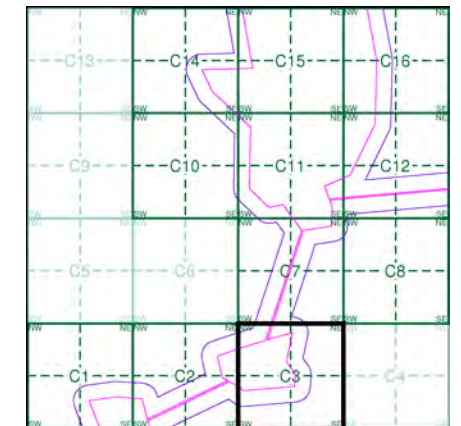

Order Details

Order Number: 297990273_1_1
 Customer Ref: 21-1088.04
 National Grid Reference: 490170, 385250
 Slice: C
 Site Area (Ha): 469.98
 Search Buffer (m): 100

Site Details

Cottam

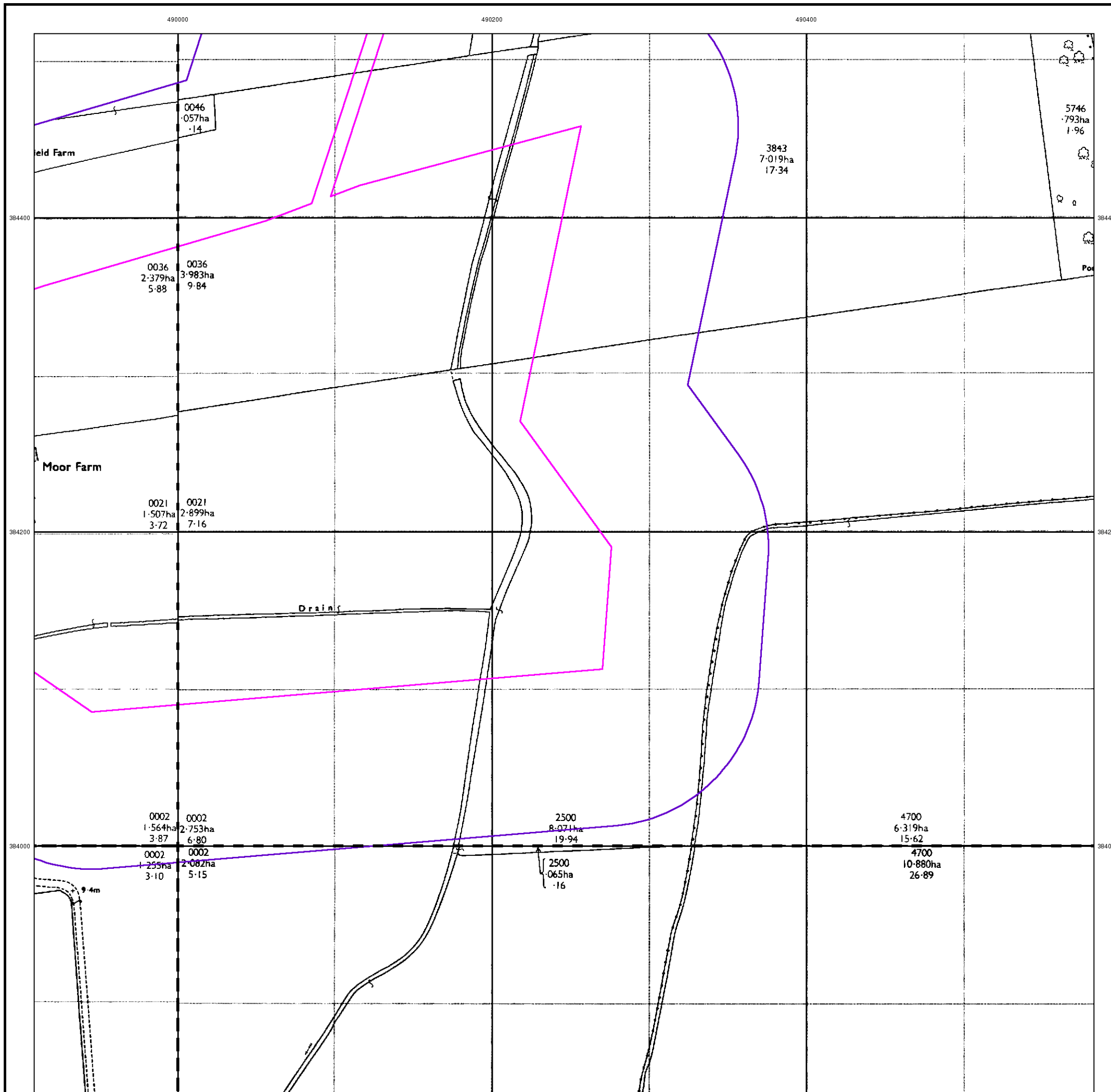

Large-Scale National Grid Data
Published 1994
Source map scale - 1:2,500

'Large Scale National Grid Data' superseded SIM cards (Ordnance Survey's 'Survey of Information on Microfilm') in 1992, and continued to be produced until 1999. These maps were the fore-runners of digital mapping and so provide detailed information on houses and roads, but tend to show less topographic features such as vegetation. These maps were produced at both 1:2,500 and 1:1,250 scales.

Map Name(s) and Date(s)

SK8984 1994 1:2,500	SK9084 1994 1:2,500
SK8983 1994 1:2,500	SK9083 1994 1:2,500

Historical Map - Segment C3

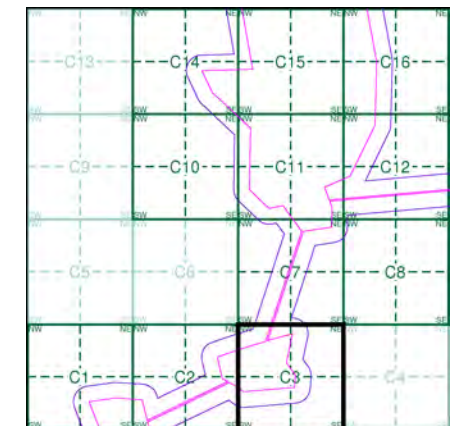

Order Details

Order Number: 297990273_1_1
 Customer Ref: 21-1088.04
 National Grid Reference: 490170, 385250
 Slice: C
 Site Area (Ha): 469.98
 Search Buffer (m): 100

Site Details

Cottam

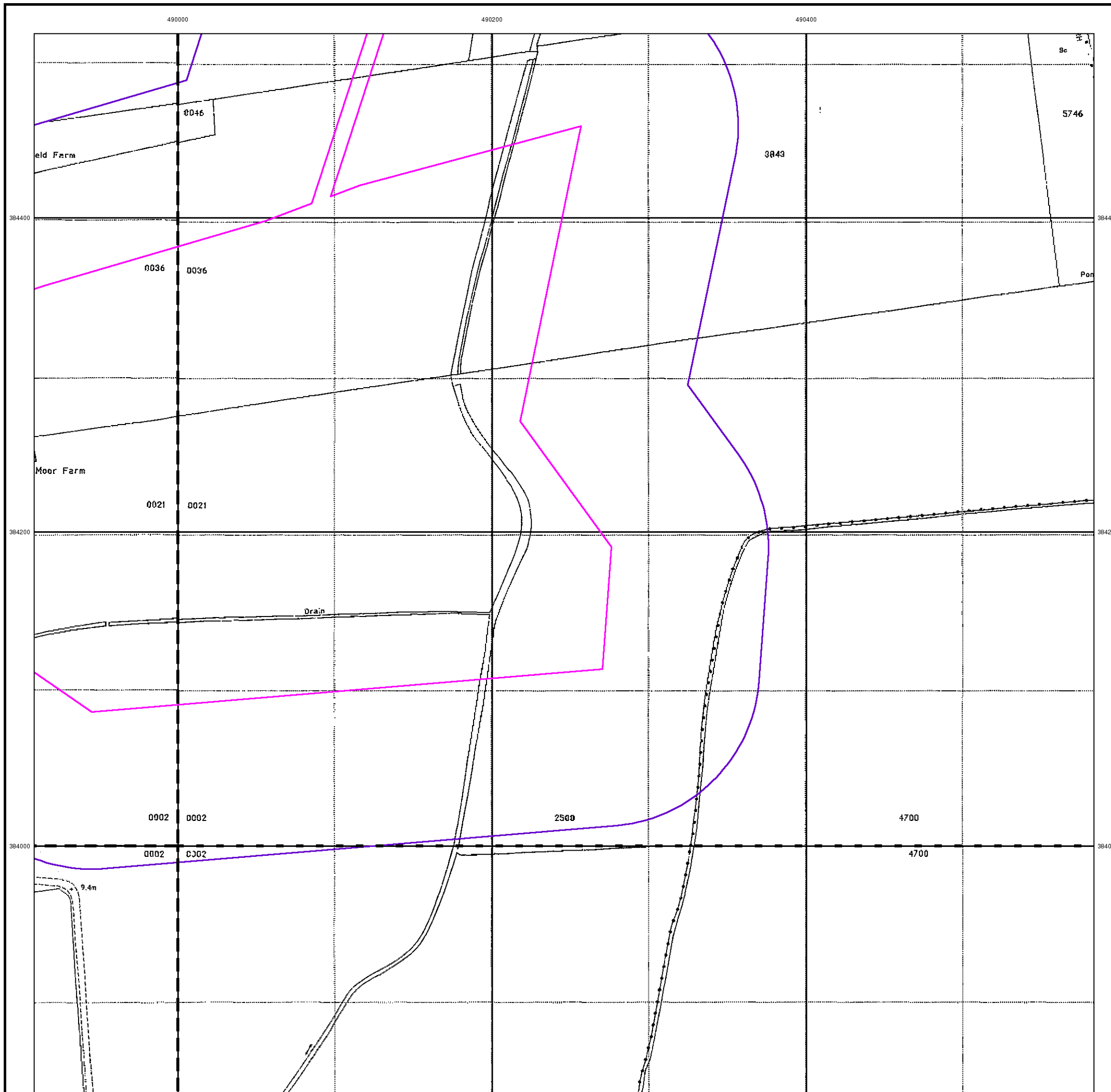

Historical Mapping Legends

Ordnance Survey County Series and Ordnance Survey Plan 1:2,500

Quarry **Gravel Pit** **Sand Pit**
Clay Pit **Shingle** **Refuse Heap**
Sloping Masonry **Flat Rock**
Marsh **Reeds** **Osiers**
Rough Pasture **Furze** **Wood**
Mixed Wood **Brushwood** **Orchard**
Fir **Ford** **Stepping Stones**
Ferry **Waterfall** **Lock**
Trig. Station **Altitude at Trig. Station**
B.M. 325.9 **Bench Mark** **Surface Level**
Arrow denotes flow of water **Antiquities (site of)**
Cutting **Embankment**
Railway crossing Road **Level Crossing** **Road crossing Railway**
Railway crossing River or Canal **Road over single stream** **Road over River or Canal**
County Boundary (Geographical)
County & Civil Parish Boundary
Administrative County & Civil Parish Boundary
County Borough Boundary (England)
County Burgh Boundary (Scotland)
Co. Boro. Bdy.
Co. Burgh Bdy.
BP BS Boundary Post or Stone **P.C.B** Police Call Box
B.R. Bridle Road **P** Pump
E.P Electricity Pylon **S.P** Signal Post
F.B. Foot Bridge **SL** Sluice
F.P. Foot Path **Sp.** Spring
G.P Guide Post or Board **T.C.B** Telephone Call Box
M.S Mile Stone **Tr.** Trough
M.P M.R Mooring Post or Ring **W** Well

Ordnance Survey Plan, Additional SIMs and Supply of Unpublished Survey Information 1:2,500 and 1:1,250

Inactive Quarry, Chalk Pit or Clay Pit **Active Quarry, Chalk Pit or Clay Pit**
Rock **Boulders**
Cliff **Slopes** **Top**
Roofed Building **Glazed Roof Building**
Sloping Masonry **Archway**
Non-Coniferous Tree (surveyed) **Coniferous Tree (surveyed)**
Non-Coniferous Trees (not surveyed) **Coniferous Trees (not surveyed)**
Orchard Tree **Scrub** **Bracken**
Coppice, Osier **Reeds** **Marsh, Saltings**
Rough Grassland **Heath** **Culvert**
Direction of water flow **Bench Mark** **Antiquity (site of)**
Cave Entrance **Triangulation Station** **Electricity Pylon**
Electricity Transmission Line
County Boundary (Geographical)
County & Civil Parish Boundary
Civil Parish Boundary
Admin. County or County Bor. Boundary
London Borough Boundary
Symbol marking point where boundary mereing changes
BH Beer House **P** Pillar, Pole or Post
BP, BS Boundary Post or Stone **PO** Post Office
Cn, C Capstan, Crane **PC** Public Convenience
Chy Chimney **PH** Public House
D Fn Drinking Fountain **Pp** Pump
EI P Electricity Pillar or Post **SB, S Br** Signal Box or Bridge
FAP Fire Alarm Pillar **SP, SL** Signal Post or Light
FB Foot Bridge **Spr** Spring
GP Guide Post **Tk** Tank or Track
H Hydrant or Hydraulic **TCB** Telephone Call Box
LC Level Crossing **TCP** Telephone Call Post
MH Manhole **Tr** Trough
MP Mile Post or Mooring Post **Wr Pt, Wr T** Water Point, Water Tap
MS Mile Stone **W** Well
NTL Normal Tidal Limit **Wd Pp** Wind Pump

Large-Scale National Grid Data 1:2,500 and 1:1,250

Cliff **Slopes** **Top**
Rock **Rock (scattered)**
Boulders **Boulders (scattered)**
Positioned Boulder **Scree**
Non-Coniferous Tree (surveyed) **Coniferous Tree (surveyed)**
Non-Coniferous Trees (not surveyed) **Coniferous Trees (not surveyed)**
Orchard Tree **Scrub** **Bracken**
Coppice, Osier **Reeds** **Marsh, Saltings**
Rough Grassland **Heath** **Culvert**
Direction of water flow **Triangulation Station** **Antiquity (site of)**
Electricity Transmission Line **Electricity Pylon**
B.M. 231.60m Bench Mark **Buildings with Building Seed**
Roofed Building **Glazed Roof Building**
Civil parish/community boundary
District boundary
County boundary
Boundary post/stone
Boundary mereing symbol (note: these always appear in opposed pairs or groups of three)
Bks Barracks **P** Pillar, Pole or Post
Bty Battery **PO** Post Office
Cemy Cemetery **PC** Public Convenience
Chy Chimney **Pp** Pump
Cis Cistern **Ppg Sta** Pumping Station
Dismtd Rly Dismantled Railway **PW** Place of Worship
EI Gen Sta Electricity Generating Station **Sewage Ppg Sta** Sewage Pumping Station
EI P Electricity Pole, Pillar **SB, S Br** Signal Box or Bridge
EI Sub Sta Electricity Sub Station **SP, SL** Signal Post or Light
FB Filter Bed **Spr** Spring
Fn / D Fn Fountain / Drinking Ftn. **Tk** Tank or Track
Gas Gov Gas Valve Compound **Tr** Trough
GVC Gas Governor **Wd Pp** Wind Pump
GP Guide Post **Wr Pt, Wr T** Water Point, Water Tap
MH Manhole **Wks** Works (building or area)
MP, MS Mile Post or Mile Stone **W** Well



Historical Mapping & Photography included:

Mapping Type	Scale	Date	Pg
Lincolnshire	1:2,500	1886	2
Lincolnshire	1:2,500	1906	3
Ordnance Survey Plan	1:2,500	1972 - 1975	4
Large-Scale National Grid Data	1:2,500	1994	5

Historical Map - Segment C7

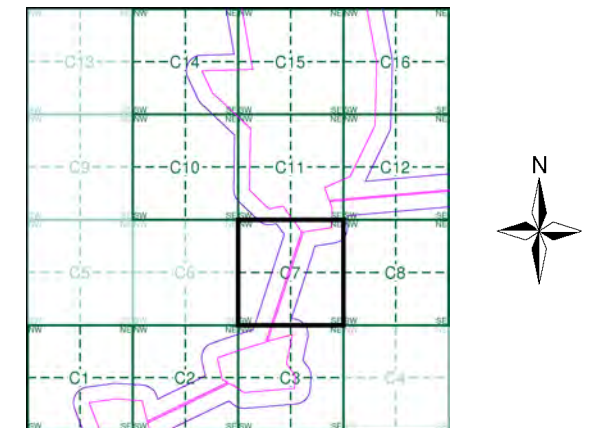

Order Details

Order Number: 297990273_1_1
 Customer Ref: 21-1088.04
 National Grid Reference: 490170, 385250
 Slice: C
 Site Area (Ha): 469.98
 Search Buffer (m): 100

Site Details

Cottam



Tel: [Redacted]
 Fax: [Redacted]
 Web: [Redacted]

Lincolnshire

Published 1886

Source map scale - 1:2,500

The historical maps shown were reproduced from maps predominantly held at the scale adopted for England, Wales and Scotland in the 1840's. In 1854 the 1:2,500 scale was adopted for mapping urban areas and by 1896 it covered the whole of what were considered to be the cultivated parts of Great Britain. The published date given below is often some years later than the surveyed date. Before 1938, all OS maps were based on the Cassini Projection, with independent surveys of a single county or group of counties, giving rise to significant inaccuracies in outlying areas.

Map Name(s) and Date(s)

051_04	1886	1:2,500
051_08	1886	1:2,500

Historical Map - Segment C7

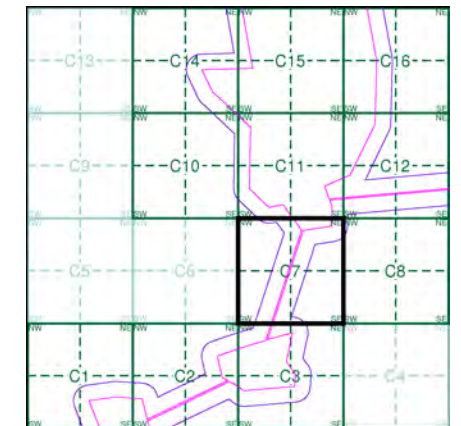

Order Details

Order Number: 297990273_1_1
 Customer Ref: 21-1088.04
 National Grid Reference: 490170, 385250
 Slice: C
 Site Area (Ha): 469.98
 Search Buffer (m): 100

Site Details

Cottam

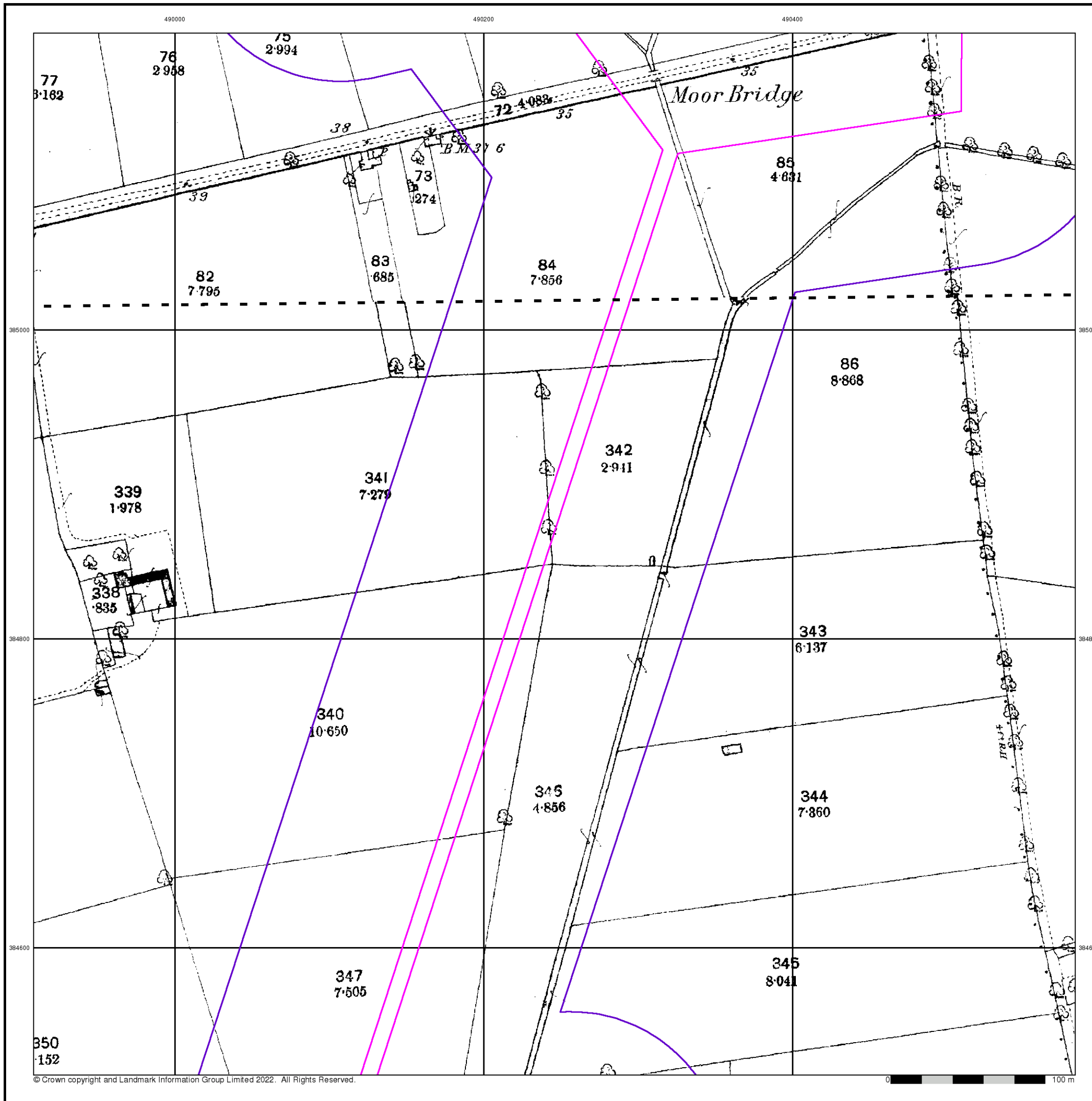

Lincolnshire

Published 1906

Source map scale - 1:2,500

The historical maps shown were reproduced from maps predominantly held at the scale adopted for England, Wales and Scotland in the 1840's. In 1854 the 1:2,500 scale was adopted for mapping urban areas and by 1896 it covered the whole of what were considered to be the cultivated parts of Great Britain. The published date given below is often some years later than the surveyed date. Before 1938, all OS maps were based on the Cassini Projection, with independent surveys of a single county or group of counties, giving rise to significant inaccuracies in outlying areas.

Map Name(s) and Date(s)

051_04	1906	1:2,500
051_08	1906	1:2,500

Historical Map - Segment C7

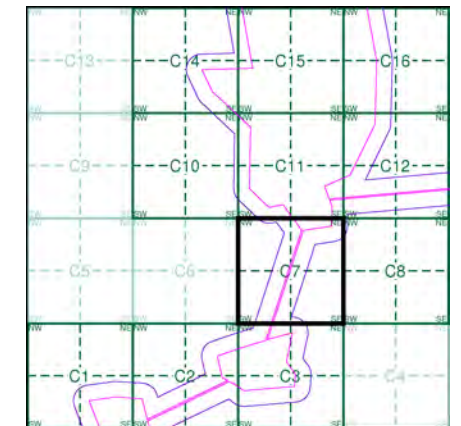

Order Details

Order Number: 297990273_1_1
 Customer Ref: 21-1088.04
 National Grid Reference: 490170, 385250
 Slice: C
 Site Area (Ha): 469.98
 Search Buffer (m): 100

Site Details

Cottam

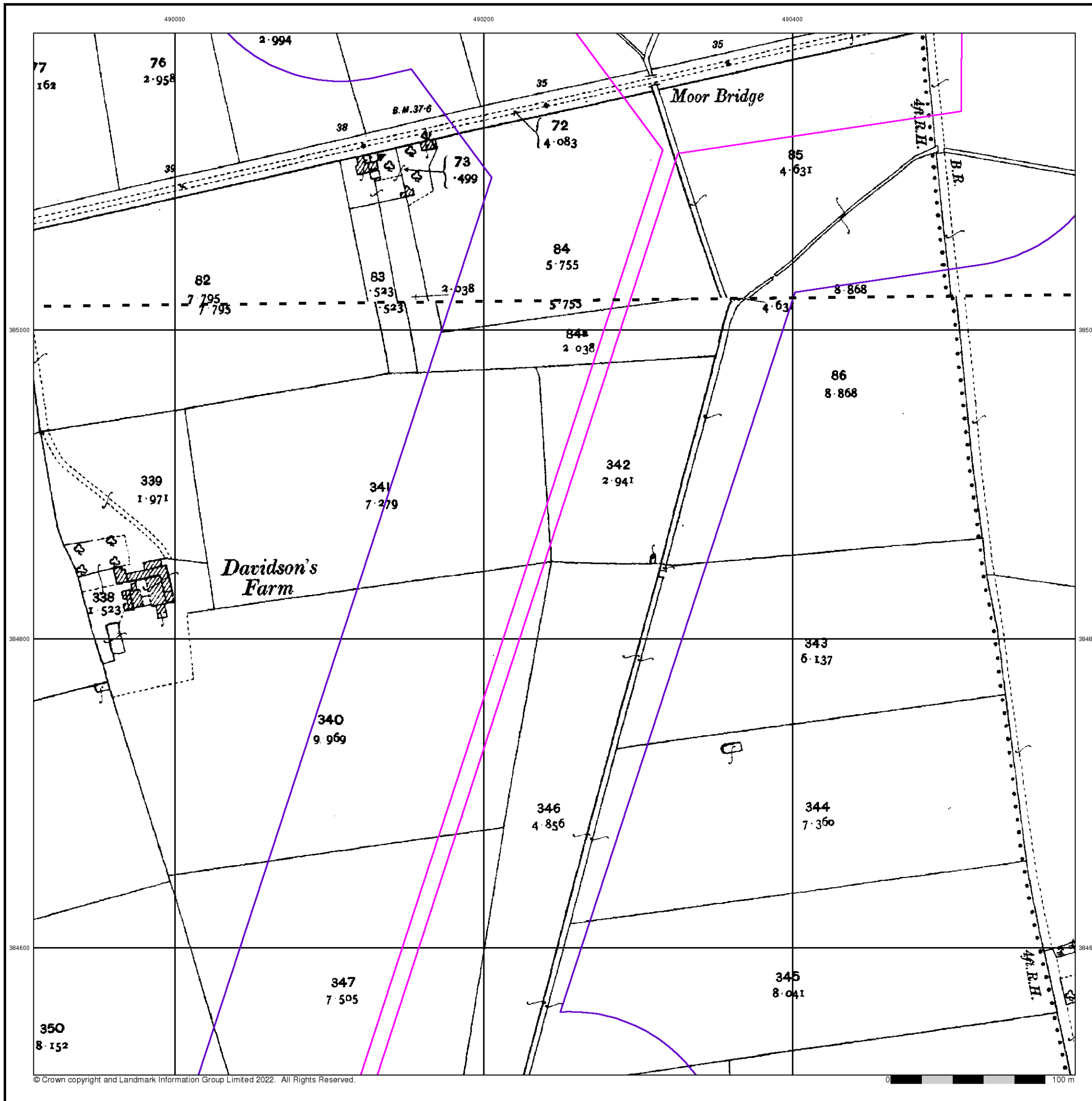

Ordnance Survey Plan
Published 1972 - 1975
Source map scale - 1:2,500

The historical maps shown were reproduced from maps predominantly held at the scale adopted for England, Wales and Scotland in the 1840's. In 1854 the 1:2,500 scale was adopted for mapping urban areas and by 1896 it covered the whole of what were considered to be the cultivated parts of Great Britain. The published date given below is often some years later than the surveyed date. Before 1938, all OS maps were based on the Cassini Projection, with independent surveys of a single county or group of counties, giving rise to significant inaccuracies in outlying areas.

Map Name(s) and Date(s)

SK8985 1972 1:2,500	SK9085 1974 1:2,500
SK8984 1975 1:2,500	SK9084 1974 1:2,500

Historical Map - Segment C7

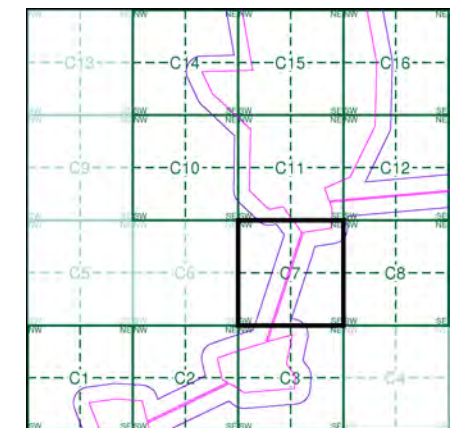

Order Details

Order Number: 297990273_1_1
 Customer Ref: 21-1088.04
 National Grid Reference: 490170, 385250
 Slice: C
 Site Area (Ha): 469.98
 Search Buffer (m): 100

Site Details

Cottam

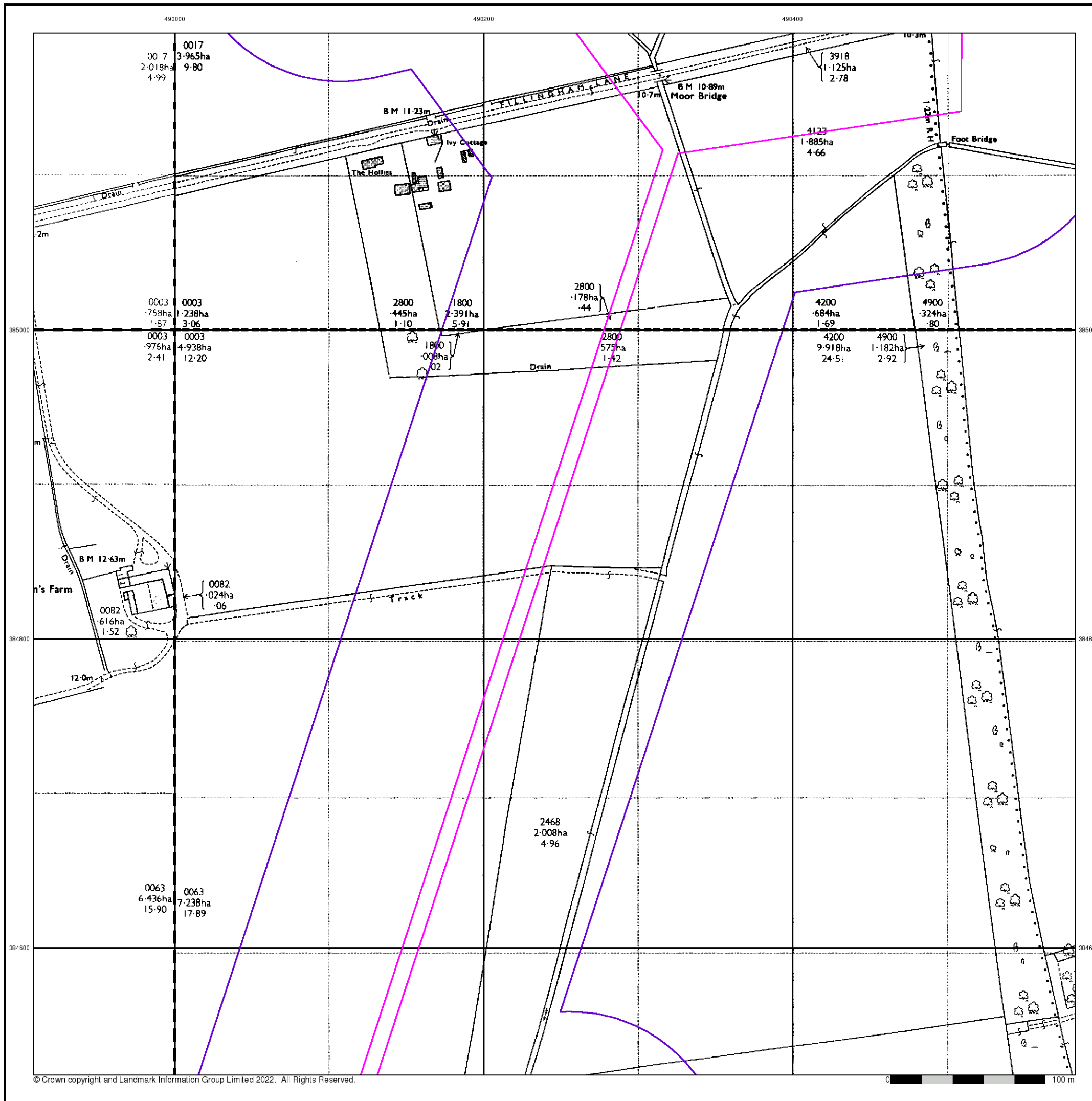

Large-Scale National Grid Data
Published 1994
Source map scale - 1:2,500

'Large Scale National Grid Data' superseded SIM cards (Ordnance Survey's 'Survey of Information on Microfilm') in 1992, and continued to be produced until 1999. These maps were the fore-runners of digital mapping and so provide detailed information on houses and roads, but tend to show less topographic features such as vegetation. These maps were produced at both 1:2,500 and 1:1,250 scales.

Map Name(s) and Date(s)

SK8985	SK9085
1994	1994
12,500	12,500
SK8984	SK9084
1994	1994
12,500	12,500

Historical Map - Segment C7

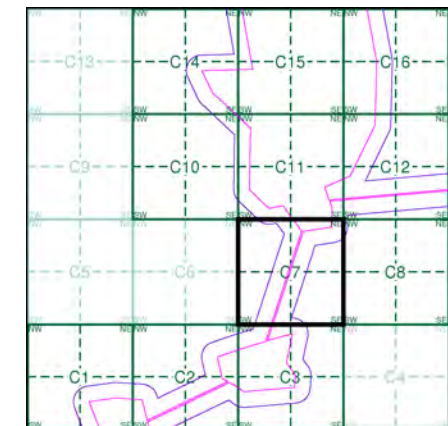

Order Details

Order Number: 297990273_1_1
 Customer Ref: 21-1088.04
 National Grid Reference: 490170, 385250
 Slice: C
 Site Area (Ha): 469.98
 Search Buffer (m): 100

Site Details

Cottam



Historical Mapping Legends

Ordnance Survey County Series and Ordnance Survey Plan 1:2,500

Quarry **Gravel Pit** **Sand Pit**
Clay Pit **Shingle** **Refuse Heap**
Sloping Masonry **Flat Rock**
Marsh **Reeds** **Osiers**
Rough Pasture **Furze** **Wood**
Mixed Wood **Brushwood** **Orchard**
Fir **Ford** **Stepping Stones**
Ferry **Waterfall** **Lock**
Trig. Station **Altitude at Trig. Station**
B.M. 325.9 **Bench Mark** **Surface Level**
Arrow denotes flow of water **Antiquities (site of)**
Cutting **Embankment**
Railway crossing Road **Level Crossing** **Road crossing Railway**
Railway crossing River or Canal **Road over single stream** **Road over River or Canal**
County Boundary (Geographical)
County & Civil Parish Boundary
Administrative County & Civil Parish Boundary
County Borough Boundary (England)
County Burgh Boundary (Scotland)
Co. Boro. Bdy.
Co. Burgh Bdy.
BP BS Boundary Post or Stone **P.C.B** Police Call Box
B.R. Bridle Road **P** Pump
E.P Electricity Pylon **S.P** Signal Post
F.B. Foot Bridge **SL** Sluice
F.P. Foot Path **Sp.** Spring
G.P Guide Post or Board **T.C.B** Telephone Call Box
M.S Mile Stone **Tr.** Trough
M.P M.R Mooring Post or Ring **W** Well

Ordnance Survey Plan, Additional SIMs and Supply of Unpublished Survey Information 1:2,500 and 1:1,250

Inactive Quarry, Chalk Pit or Clay Pit **Active Quarry, Chalk Pit or Clay Pit**
Rock **Boulders**
Cliff **Slopes** **Top**
Roofed Building **Glazed Roof Building**
Sloping Masonry **Archway**
Non-Coniferous Tree (surveyed) **Coniferous Tree (surveyed)**
Non-Coniferous Trees (not surveyed) **Coniferous Trees (not surveyed)**
Orchard Tree **Scrub** **Bracken**
Coppice, Osier **Reeds** **Marsh, Saltings**
Rough Grassland **Heath** **Culvert**
Direction of water flow **Bench Mark** **Antiquity (site of)**
Cave Entrance **Triangulation Station** **Electricity Pylon**
Electricity Transmission Line
County Boundary (Geographical)
County & Civil Parish Boundary
Civil Parish Boundary
Admin. County or County Bor. Boundary
London Borough Boundary
Symbol marking point where boundary mereing changes
BH Beer House **P** Pillar, Pole or Post
BP, BS Boundary Post or Stone **PO** Post Office
Cn, C Capstan, Crane **PC** Public Convenience
Chy Chimney **PH** Public House
D Fn Drinking Fountain **Pp** Pump
EI P Electricity Pillar or Post **SB, S Br** Signal Box or Bridge
FAP Fire Alarm Pillar **SP, SL** Signal Post or Light
FB Foot Bridge **Spr** Spring
GP Guide Post **Tk** Tank or Track
H Hydrant or Hydraulic **TCB** Telephone Call Box
LC Level Crossing **TCP** Telephone Call Post
MH Manhole **Tr** Trough
MP Mile Post or Mooring Post **Wr Pt, Wr T** Water Point, Water Tap
MS Mile Stone **W** Well
NTL Normal Tidal Limit **Wd Pp** Wind Pump

Large-Scale National Grid Data 1:2,500 and 1:1,250

Cliff **Slopes** **Top**
Rock **Rock (scattered)**
Boulders **Boulders (scattered)**
Positioned Boulder **Scree**
Non-Coniferous Tree (surveyed) **Coniferous Tree (surveyed)**
Non-Coniferous Trees (not surveyed) **Coniferous Trees (not surveyed)**
Orchard Tree **Scrub** **Bracken**
Coppice, Osier **Reeds** **Marsh, Saltings**
Rough Grassland **Heath** **Culvert**
Direction of water flow **Triangulation Station** **Antiquity (site of)**
Electricity Transmission Line **Electricity Pylon**
B.M. 231.60m Bench Mark **Buildings with Building Seed**
Roofed Building **Glazed Roof Building**
Civil parish/community boundary
District boundary
County boundary
Boundary post/stone
Boundary mereing symbol (note: these always appear in opposed pairs or groups of three)
Bks Barracks **P** Pillar, Pole or Post
Bty Battery **PO** Post Office
Cemy Cemetery **PC** Public Convenience
Chy Chimney **Pp** Pump
Cis Cistern **Ppg Sta** Pumping Station
Dismtd Rly Dismantled Railway **PW** Place of Worship
EI Gen Sta Electricity Generating Station **Sewage Ppg Sta** Sewage Pumping Station
EI P Electricity Pole, Pillar **SB, S Br** Signal Box or Bridge
EI Sub Sta Electricity Sub Station **SP, SL** Signal Post or Light
FB Filter Bed **Spr** Spring
Fn / D Fn Fountain / Drinking Ftn. **Tk** Tank or Track
Gas Gov Gas Valve Compound **Tr** Trough
GVC Gas Governor **Wd Pp** Wind Pump
GP Guide Post **Wr Pt, Wr T** Water Point, Water Tap
MH Manhole **Wks** Works (building or area)
MP, MS Mile Post or Mile Stone **W** Well



Historical Mapping & Photography included:

Mapping Type	Scale	Date	Pg
Lincolnshire	1:2,500	1886	2
Lincolnshire	1:2,500	1906	3
Ordnance Survey Plan	1:2,500	1974	4
Large-Scale National Grid Data	1:2,500	1994	5

Historical Map - Segment C8

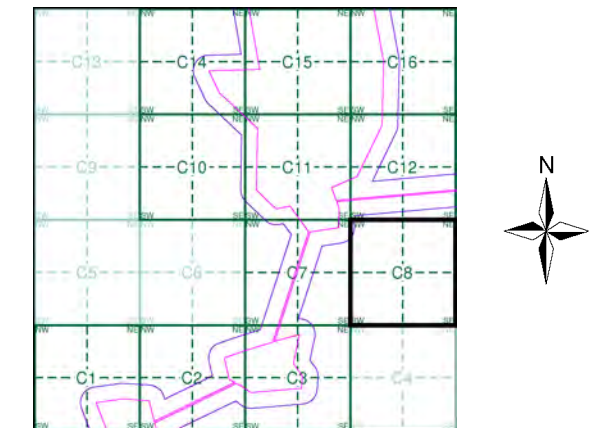

Order Details

Order Number: 297990273_1_1
 Customer Ref: 21-1088.04
 National Grid Reference: 490170, 385250
 Slice: C
 Site Area (Ha): 469.98
 Search Buffer (m): 100

Site Details

Cottam



Tel:
Fax:
Web:

Lincolnshire

Published 1886

Source map scale - 1:2,500

The historical maps shown were reproduced from maps predominantly held at the scale adopted for England, Wales and Scotland in the 1840's. In 1854 the 1:2,500 scale was adopted for mapping urban areas and by 1896 it covered the whole of what were considered to be the cultivated parts of Great Britain. The published date given below is often some years later than the surveyed date. Before 1938, all OS maps were based on the Cassini Projection, with independent surveys of a single county or group of counties, giving rise to significant inaccuracies in outlying areas.

Map Name(s) and Date(s)

051_04
1886
1:2,500
051_08
1886
1:2,500

Historical Map - Segment C8

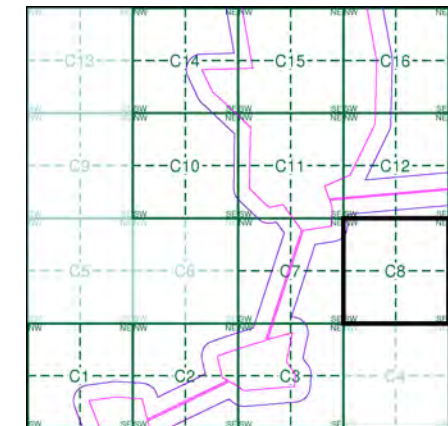

Order Details

Order Number: 297990273_1_1
 Customer Ref: 21-1088.04
 National Grid Reference: 490170, 385250
 Slice: C
 Site Area (Ha): 469.98
 Search Buffer (m): 100

Site Details

Cottam

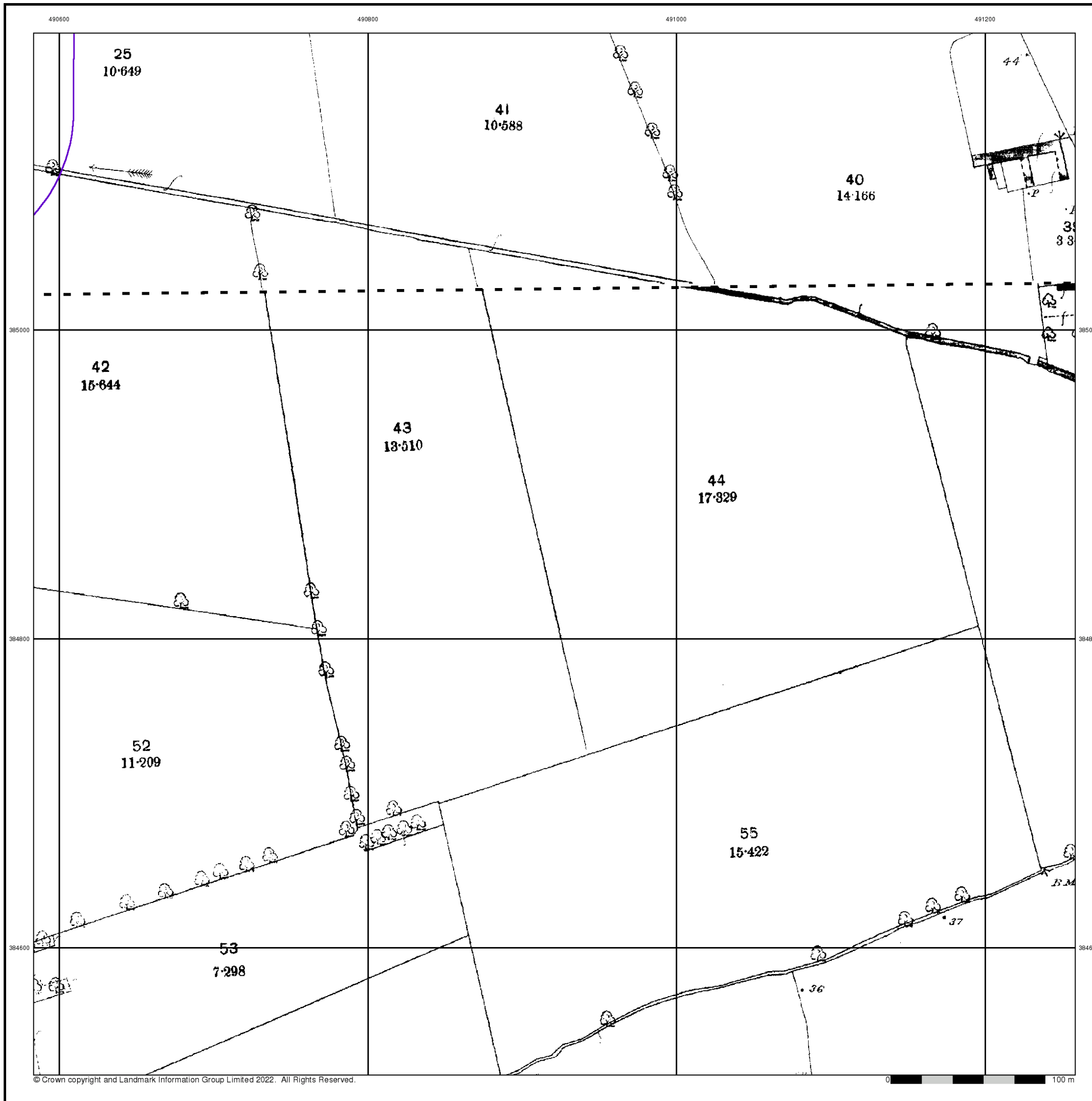

Lincolnshire

Published 1906

Source map scale - 1:2,500

The historical maps shown were reproduced from maps predominantly held at the scale adopted for England, Wales and Scotland in the 1840's. In 1854 the 1:2,500 scale was adopted for mapping urban areas and by 1896 it covered the whole of what were considered to be the cultivated parts of Great Britain. The published date given below is often some years later than the surveyed date. Before 1938, all OS maps were based on the Cassini Projection, with independent surveys of a single county or group of counties, giving rise to significant inaccuracies in outlying areas.

Map Name(s) and Date(s)

051_04
1906
1:2,500
051_08
1906
1:2,500

Historical Map - Segment C8

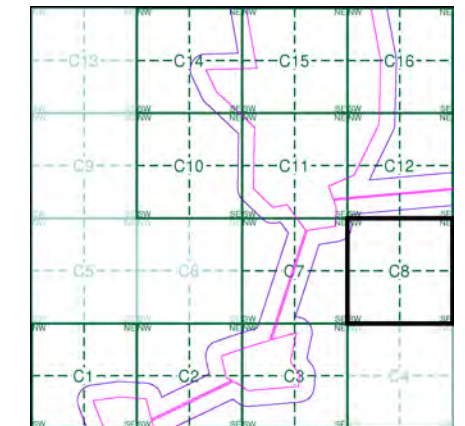

Order Details

Order Number: 297990273_1_1
 Customer Ref: 21-1088.04
 National Grid Reference: 490170, 385250
 Slice: C
 Site Area (Ha): 469.98
 Search Buffer (m): 100

Site Details

Cottam

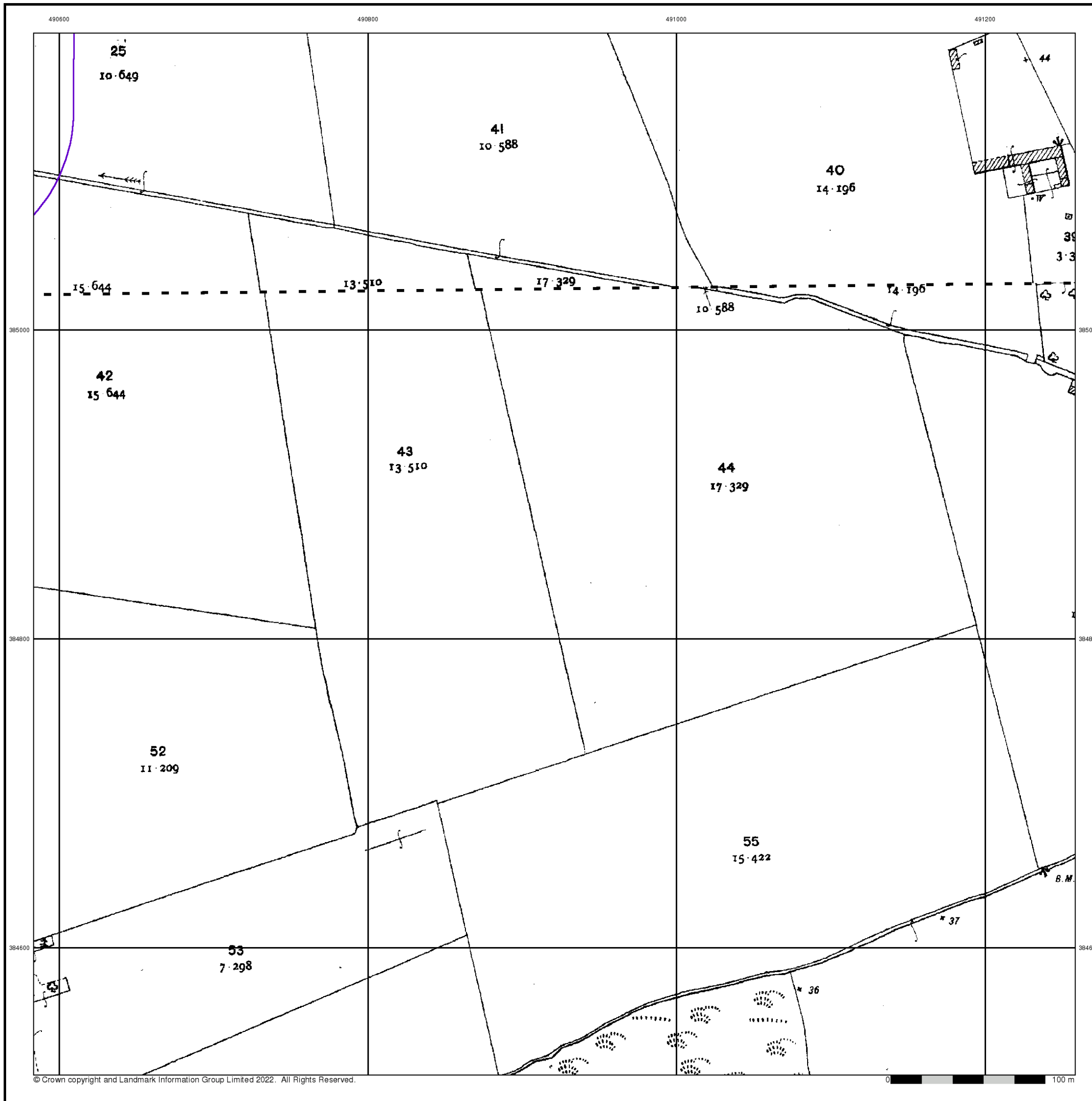

Ordnance Survey Plan

Published 1974

Source map scale - 1:2,500

The historical maps shown were reproduced from maps predominantly held at the scale adopted for England, Wales and Scotland in the 1840's. In 1854 the 1:2,500 scale was adopted for mapping urban areas and by 1896 it covered the whole of what were considered to be the cultivated parts of Great Britain. The published date given below is often some years later than the surveyed date. Before 1938, all OS maps were based on the Cassini Projection, with independent surveys of a single county or group of counties, giving rise to significant inaccuracies in outlying areas.

Map Name(s) and Date(s)

SK9085 1974 12,500	SK9185 1974 12,500
SK9084 1974 12,500	SK9184 1974 12,500

Historical Map - Segment C8

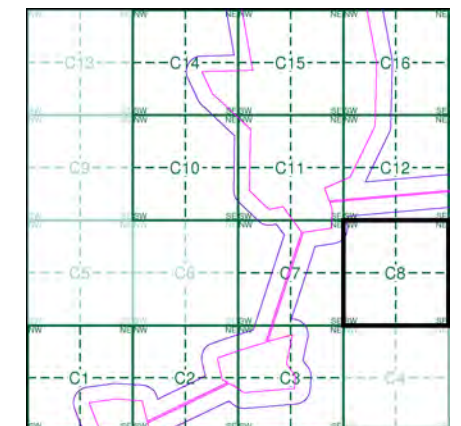

Order Details

Order Number: 297990273_1_1
 Customer Ref: 21-1088.04
 National Grid Reference: 490170, 385250
 Slice: C
 Site Area (Ha): 469.98
 Search Buffer (m): 100

Site Details

Cottam

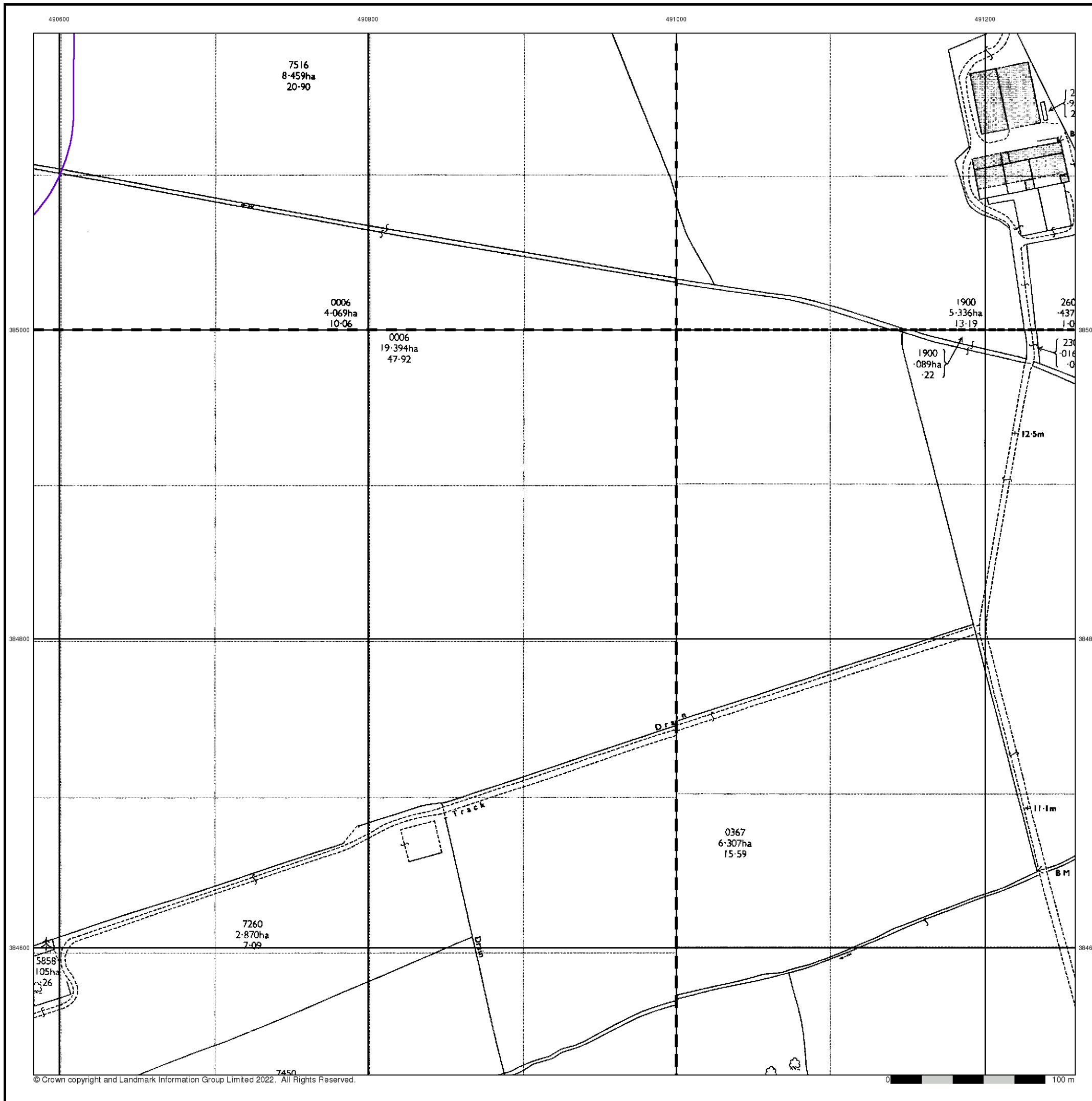

Large-Scale National Grid Data

Published 1994

Source map scale - 1:2,500

'Large Scale National Grid Data' superseded SIM cards (Ordnance Survey's 'Survey of Information on Microfilm') in 1992, and continued to be produced until 1999. These maps were the fore-runners of digital mapping and so provide detailed information on houses and roads, but tend to show less topographic features such as vegetation. These maps were produced at both 1:2,500 and 1:1,250 scales.

Map Name(s) and Date(s)

SK9085	SK9185
1994	1994
1:2,500	1:2,500
SK9084	SK9184
1994	1994
1:2,500	1:2,500

Historical Map - Segment C8

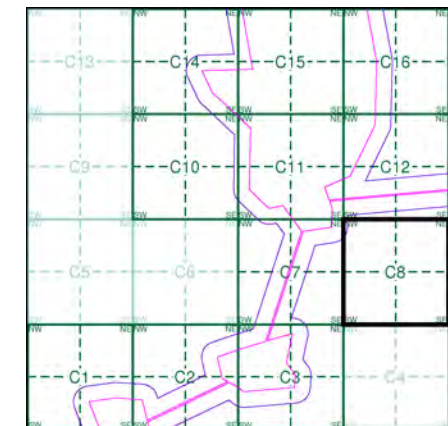

Order Details

Order Number: 297990273_1_1
 Customer Ref: 21-1088.04
 National Grid Reference: 490170, 385250
 Slice: C
 Site Area (Ha): 469.98
 Search Buffer (m): 100

Site Details

Cottam

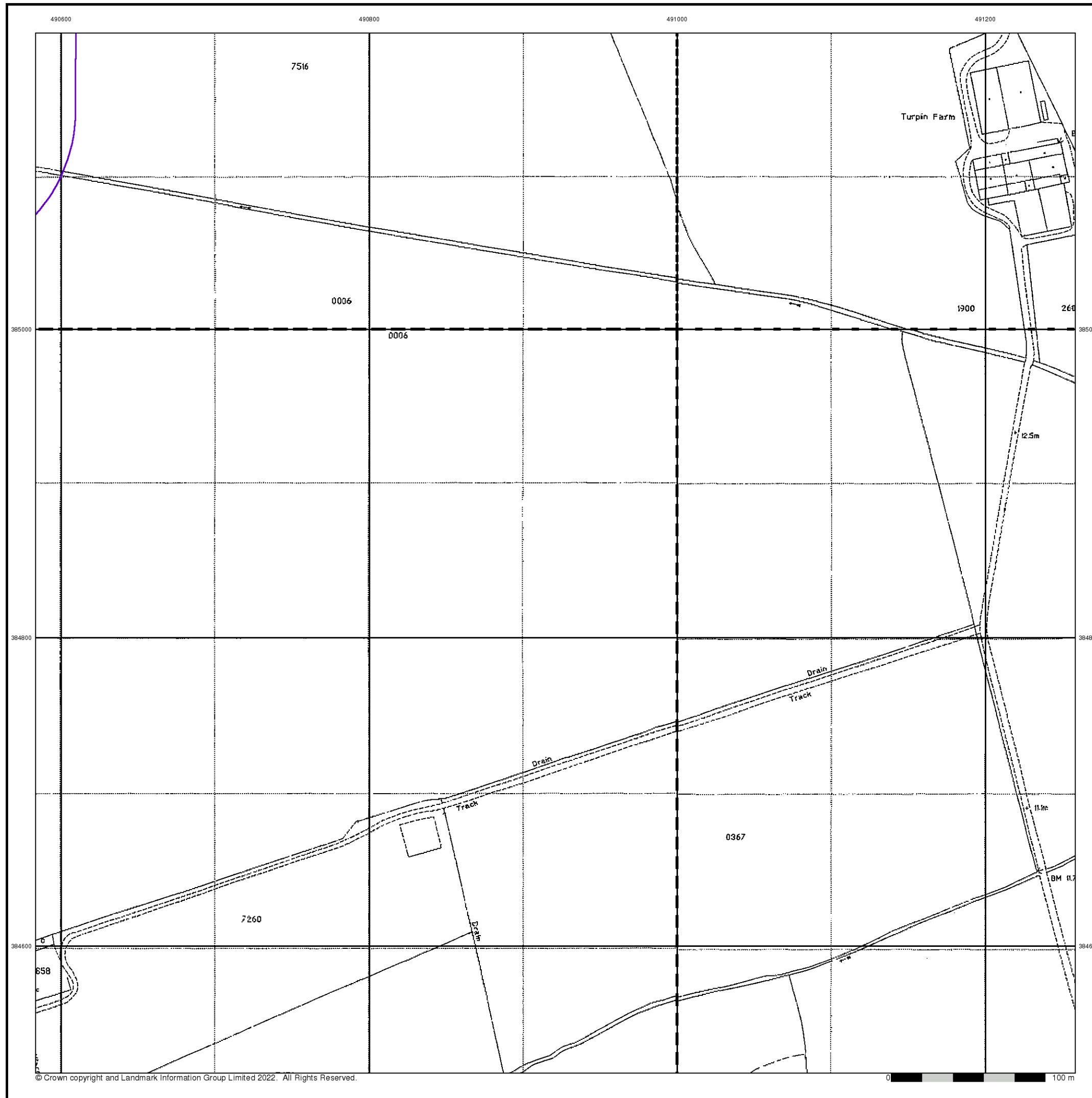

Historical Mapping Legends

Ordnance Survey County Series and Ordnance Survey Plan 1:2,500

Quarry **Gravel Pit** **Sand Pit**
Clay Pit **Shingle** **Refuse Heap**
Sloping Masonry **Flat Rock**
Marsh **Reeds** **Osiers**
Rough Pasture **Furze** **Wood**
Mixed Wood **Brushwood** **Orchard**
Fir **Ford** **Stepping Stones**
Ferry **Waterfall** **Lock**
Trig. Station **Altitude at Trig. Station**
B.M. 325.9 **Bench Mark** **Surface Level**
Arrow denotes flow of water **Antiquities (site of)**
Cutting **Embankment**
Railway crossing Road **Level Crossing** **Road crossing Railway**
Railway crossing River or Canal **Road over single stream** **Road over River or Canal**
County Boundary (Geographical)
County & Civil Parish Boundary
Administrative County & Civil Parish Boundary
County Borough Boundary (England)
Co. Boro. Bdy.
County Burgh Boundary (Scotland)
Boundary Post or Stone **Police Call Box**
B.R. **Bridle Road** **P** **Pump**
E.P. **Electricity Pylon** **S.P.** **Signal Post**
F.B. **Foot Bridge** **Sl.** **Sluice**
F.P. **Foot Path** **Sp.** **Spring**
G.P. **Guide Post or Board** **T.C.B.** **Telephone Call Box**
M.S. **Mile Stone** **Tr.** **Trough**
M.P. M.R. **Mooring Post or Ring** **W** **Well**

Ordnance Survey Plan, Additional SIMs and Supply of Unpublished Survey Information 1:2,500 and 1:1,250

Inactive Quarry, Chalk Pit or Clay Pit **Active Quarry, Chalk Pit or Clay Pit**
Rock **Boulders**
Cliff **Slopes** **Top**
Roofed Building **Glazed Roof Building**
Sloping Masonry **Archway**
Non-Coniferous Tree (surveyed) **Coniferous Tree (surveyed)**
Non-Coniferous Trees (not surveyed) **Coniferous Trees (not surveyed)**
Orchard Tree **Scrub** **Bracken**
Coppice, Osier **Reeds** **Marsh, Saltings**
Rough Grassland **Heath** **Culvert**
Direction of water flow **Bench Mark** **Antiquity (site of)**
Cave Entrance **Triangulation Station** **Electricity Pylon**
Electricity Transmission Line
County Boundary (Geographical)
County & Civil Parish Boundary
Civil Parish Boundary
Admin. County or County Bor. Boundary
London Borough Boundary
Symbol marking point where boundary mereing changes
BH **Beer House** **P** **Pillar, Pole or Post**
BP, BS **Boundary Post or Stone** **PO** **Post Office**
Cn, C **Capstan, Crane** **PC** **Public Convenience**
Chy **Chimney** **PH** **Public House**
D Fn **Drinking Fountain** **Pp** **Pump**
EI P **Electricity Pillar or Post** **SB, S Br** **Signal Box or Bridge**
FAP **Fire Alarm Pillar** **SP, SL** **Signal Post or Light**
FB **Foot Bridge** **Spr** **Spring**
GP **Guide Post** **Tk** **Tank or Track**
H **Hydrant or Hydraulic** **TCB** **Telephone Call Box**
LC **Level Crossing** **TCP** **Telephone Call Post**
MH **Manhole** **Tr** **Trough**
MP **Mile Post or Mooring Post** **Wr Pt, Wr T** **Water Point, Water Tap**
MS **Mile Stone** **W** **Well**
NTL **Normal Tidal Limit** **Wd Pp** **Wind Pump**

Large-Scale National Grid Data 1:2,500 and 1:1,250

Cliff **Slopes** **Top**
Rock **Rock (scattered)**
Boulders **Boulders (scattered)**
Positioned Boulder **Scree**
Non-Coniferous Tree (surveyed) **Coniferous Tree (surveyed)**
Non-Coniferous Trees (not surveyed) **Coniferous Trees (not surveyed)**
Orchard Tree **Scrub** **Bracken**
Coppice, Osier **Reeds** **Marsh, Saltings**
Rough Grassland **Heath** **Culvert**
Direction of water flow **Triangulation Station** **Antiquity (site of)**
Electricity Transmission Line **Electricity Pylon**
B.M. 231.60m **Bench Mark** **Buildings with Building Seed**
Roofed Building **Glazed Roof Building**
Civil parish/community boundary
District boundary
County boundary
Boundary post/stone
Boundary mereing symbol (note: these always appear in opposed pairs or groups of three)
Bks **Barracks** **P** **Pillar, Pole or Post**
Bty **Battery** **PO** **Post Office**
Cemy **Cemetery** **PC** **Public Convenience**
Chy **Chimney** **Pp** **Pump**
Cis **Cistern** **Ppg Sta** **Pumping Station**
Dismtd Rly **Dismantled Railway** **PW** **Place of Worship**
EI Gen Sta **Electricity Generating Station** **Sewage Ppg Sta** **Sewage Pumping Station**
EI P **Electricity Pole, Pillar** **SB, S Br** **Signal Box or Bridge**
EI Sub Sta **Electricity Sub Station** **SP, SL** **Signal Post or Light**
FB **Filter Bed** **Spr** **Spring**
Fn / D Fn **Fountain / Drinking Ftn.** **Tk** **Tank or Track**
Gas Gov **Gas Valve Compound** **Tr** **Trough**
GVC **Gas Governor** **Wd Pp** **Wind Pump**
GP **Guide Post** **Wr Pt, Wr T** **Water Point, Water Tap**
MH **Manhole** **Wks** **Works (building or area)**
MP, MS **Mile Post or Mile Stone** **W** **Well**



Historical Mapping & Photography included:

Mapping Type	Scale	Date	Pg
Lincolnshire	1:2,500	1886	2
Lincolnshire	1:2,500	1906	3
Ordnance Survey Plan	1:2,500	1972	4
Large-Scale National Grid Data	1:2,500	1994	5

Historical Map - Segment C10

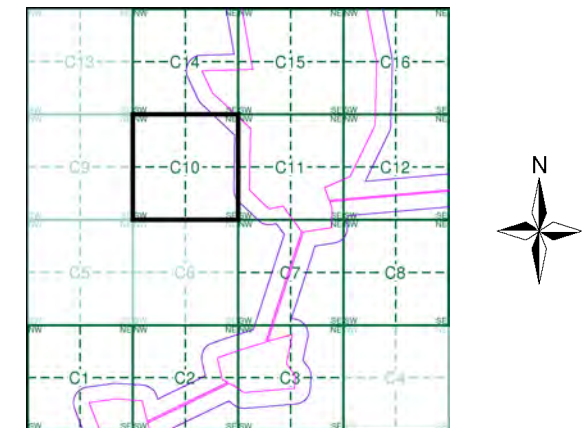

Order Details

Order Number: 297990273_1_1
 Customer Ref: 21-1088.04
 National Grid Reference: 490170, 385250
 Slice: C
 Site Area (Ha): 469.98
 Search Buffer (m): 100

Site Details

Cottam



Tel: [Redacted]
 Fax: [Redacted]
 Web: [Redacted]

Lincolnshire

Published 1886

Source map scale - 1:2,500

The historical maps shown were reproduced from maps predominantly held at the scale adopted for England, Wales and Scotland in the 1840's. In 1854 the 1:2,500 scale was adopted for mapping urban areas and by 1896 it covered the whole of what were considered to be the cultivated parts of Great Britain. The published date given below is often some years later than the surveyed date. Before 1938, all OS maps were based on the Cassini Projection, with independent surveys of a single county or group of counties, giving rise to significant inaccuracies in outlying areas.

Map Name(s) and Date(s)

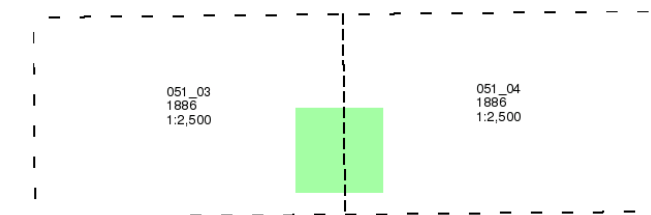

Historical Map - Segment C10

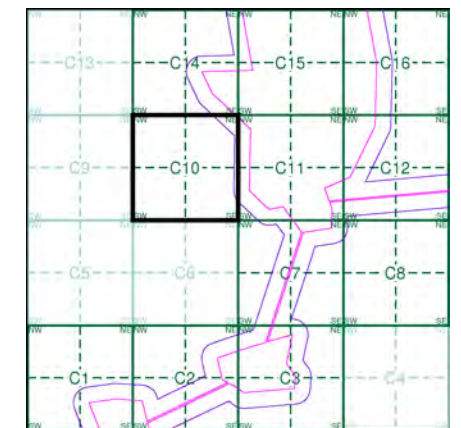

Order Details

Order Number: 297990273_1_1
 Customer Ref: 21-1088.04
 National Grid Reference: 490170, 385250
 Slice: C
 Site Area (Ha): 469.98
 Search Buffer (m): 100

Site Details

Cottam

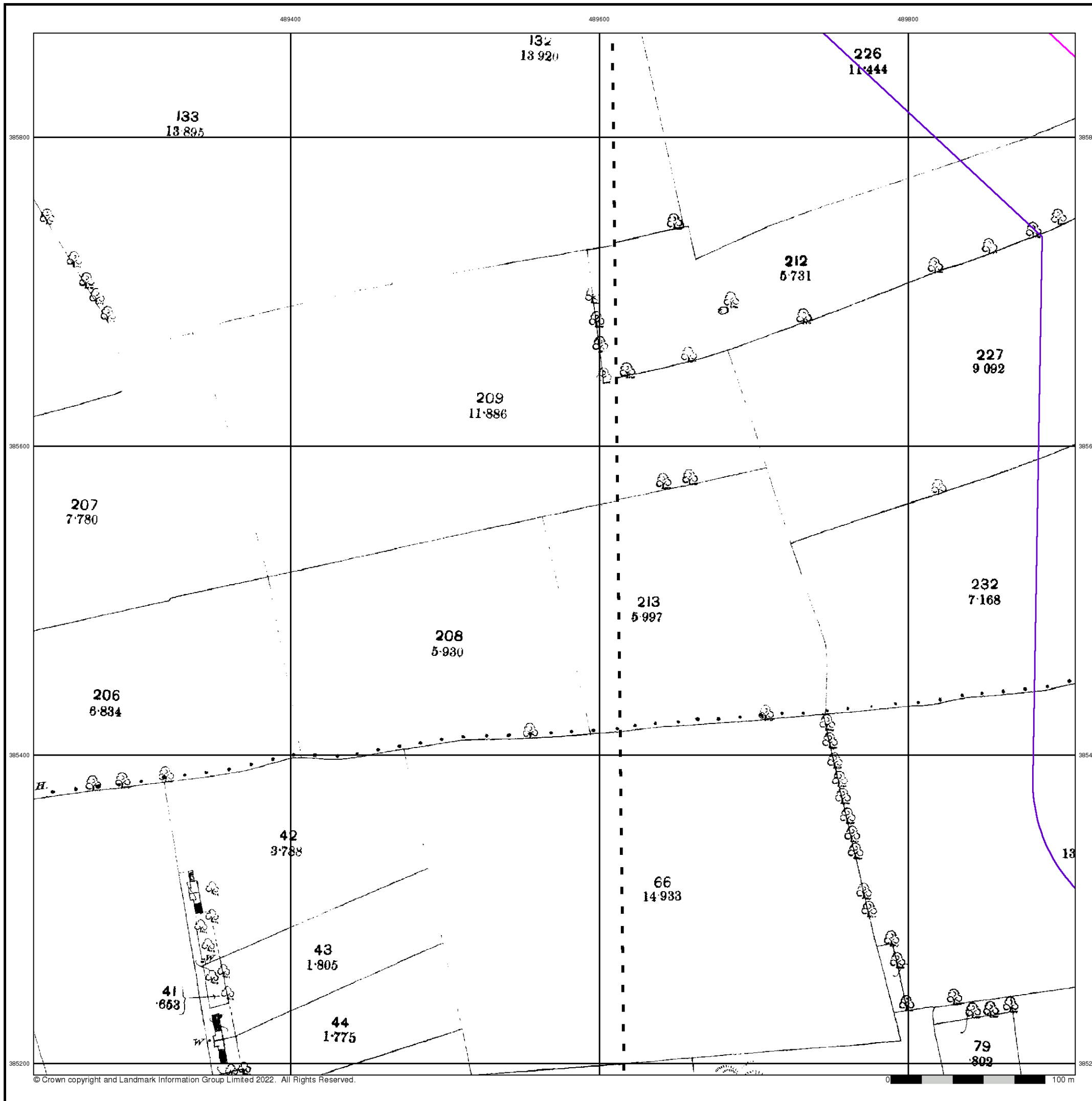

Lincolnshire

Published 1906

Source map scale - 1:2,500

The historical maps shown were reproduced from maps predominantly held at the scale adopted for England, Wales and Scotland in the 1840's. In 1854 the 1:2,500 scale was adopted for mapping urban areas and by 1896 it covered the whole of what were considered to be the cultivated parts of Great Britain. The published date given below is often some years later than the surveyed date. Before 1938, all OS maps were based on the Cassini Projection, with independent surveys of a single county or group of counties, giving rise to significant inaccuracies in outlying areas.

Map Name(s) and Date(s)

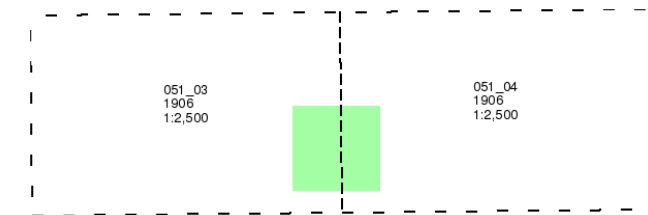

Historical Map - Segment C10

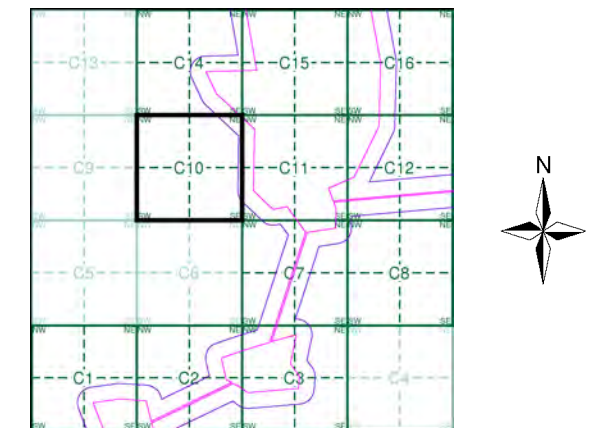

Order Details

Order Number: 297990273_1_1
 Customer Ref: 21-1088.04
 National Grid Reference: 490170, 385250
 Slice: C
 Site Area (Ha): 469.98
 Search Buffer (m): 100

Site Details

Cottam

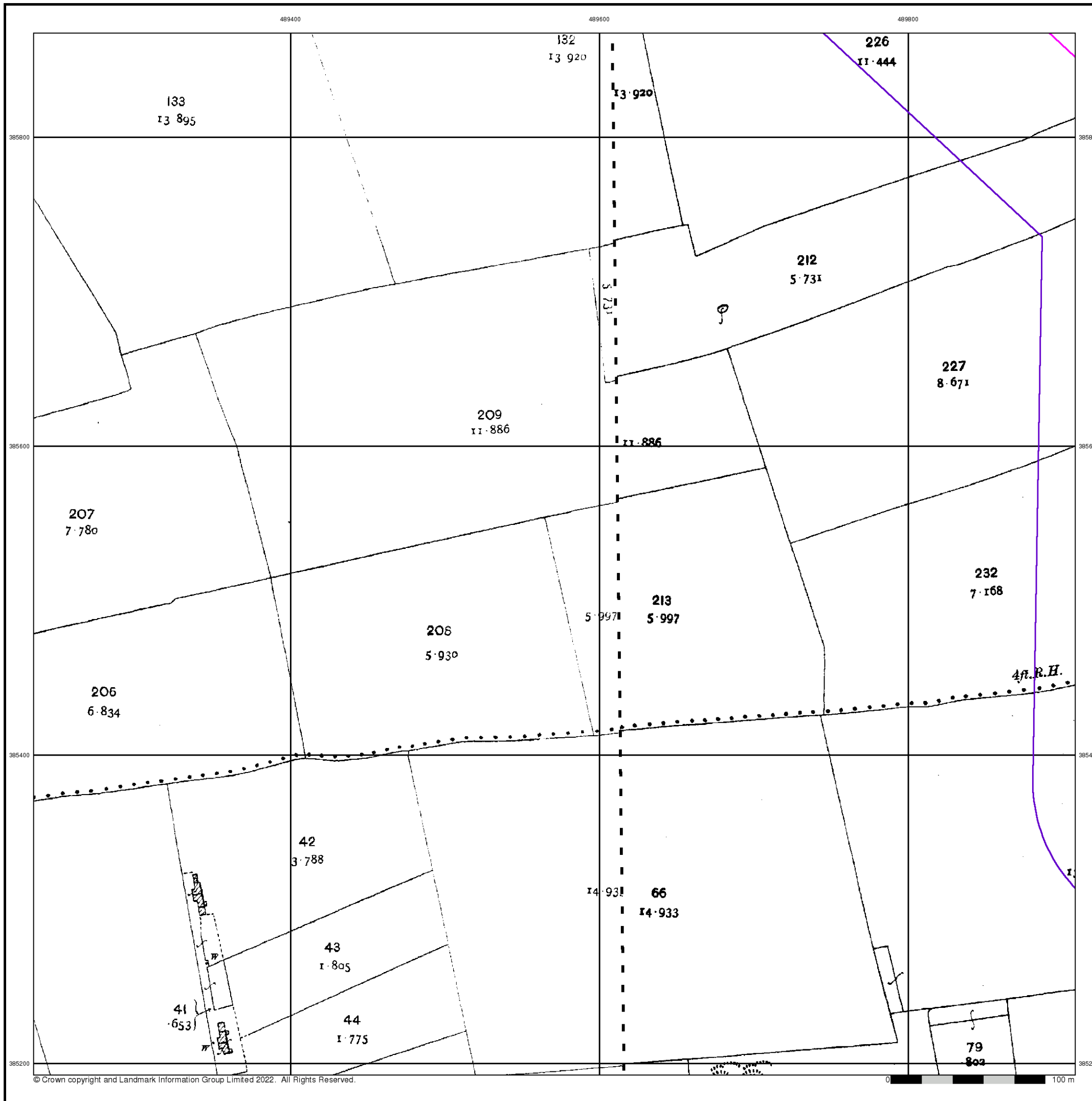

Ordnance Survey Plan

Published 1972

Source map scale - 1:2,500

The historical maps shown were reproduced from maps predominantly held at the scale adopted for England, Wales and Scotland in the 1840's. In 1854 the 1:2,500 scale was adopted for mapping urban areas and by 1896 it covered the whole of what were considered to be the cultivated parts of Great Britain. The published date given below is often some years later than the surveyed date. Before 1938, all OS maps were based on the Cassini Projection, with independent surveys of a single county or group of counties, giving rise to significant inaccuracies in outlying areas.

Map Name(s) and Date(s)

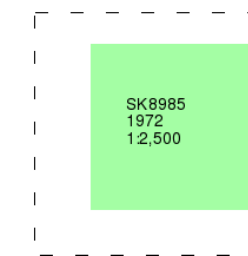

Historical Map - Segment C10

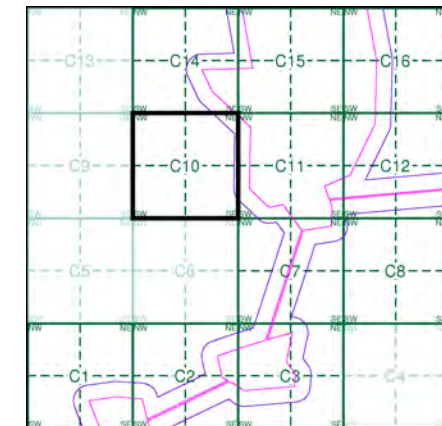

Order Details

Order Number: 297990273_1_1
 Customer Ref: 21-1088.04
 National Grid Reference: 490170, 385250
 Slice: C
 Site Area (Ha): 469.98
 Search Buffer (m): 100

Site Details

Cottam

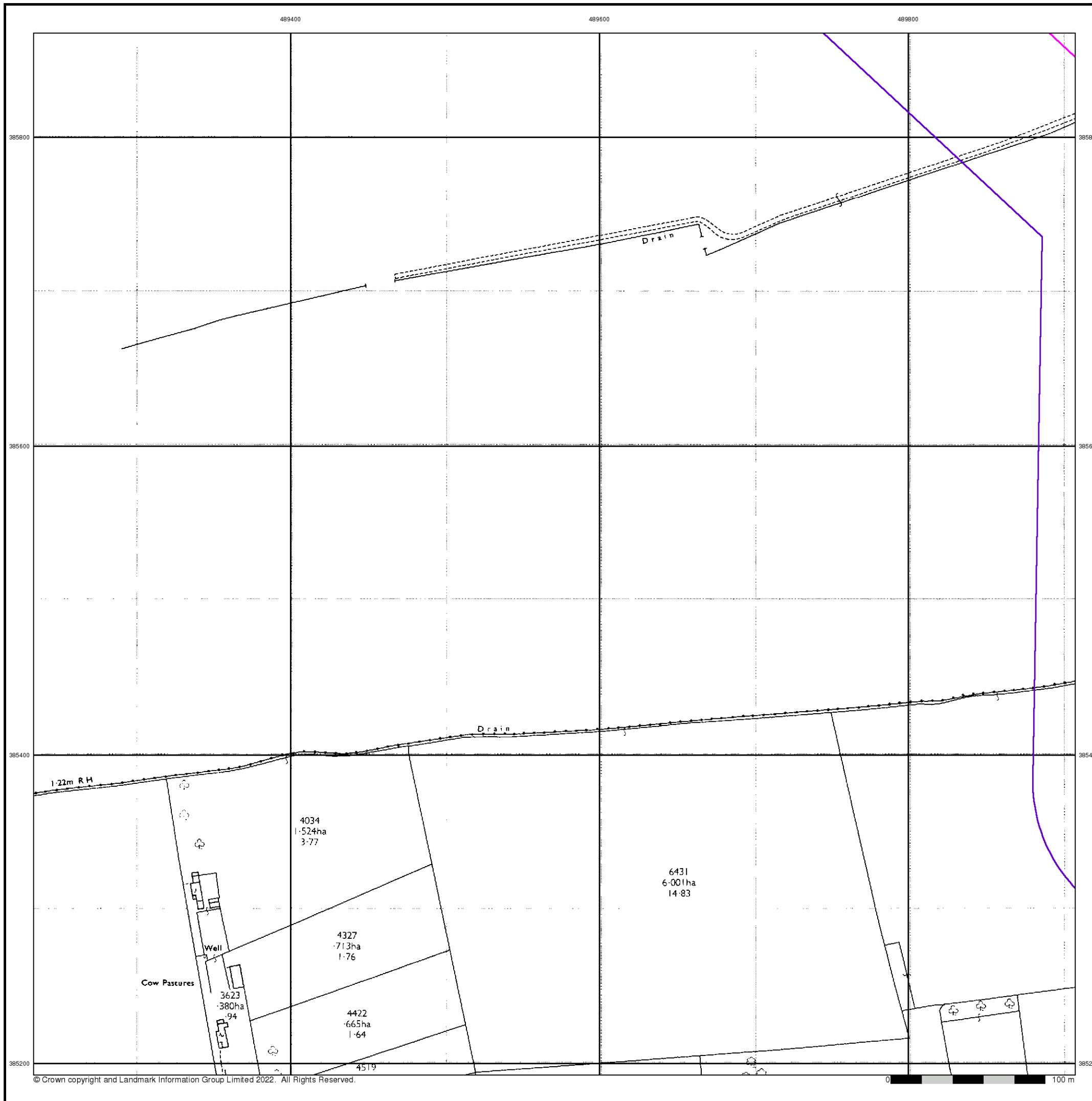

Large-Scale National Grid Data

Published 1994

Source map scale - 1:2,500

'Large Scale National Grid Data' superseded SIM cards (Ordnance Survey's 'Survey of Information on Microfilm') in 1992, and continued to be produced until 1999. These maps were the fore-runners of digital mapping and so provide detailed information on houses and roads, but tend to show less topographic features such as vegetation. These maps were produced at both 1:2,500 and 1:1,250 scales.

Map Name(s) and Date(s)

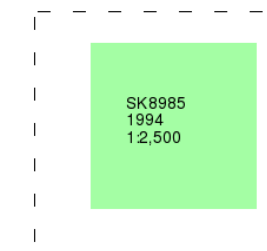

Historical Map - Segment C10

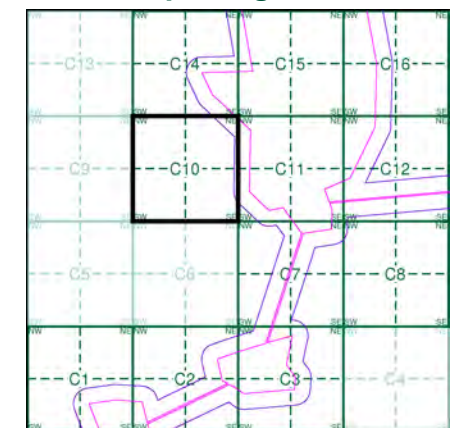

Order Details

Order Number: 297990273_1_1
 Customer Ref: 21-1088.04
 National Grid Reference: 490170, 385250
 Slice: C
 Site Area (Ha): 469.98
 Search Buffer (m): 100

Site Details

Cottam

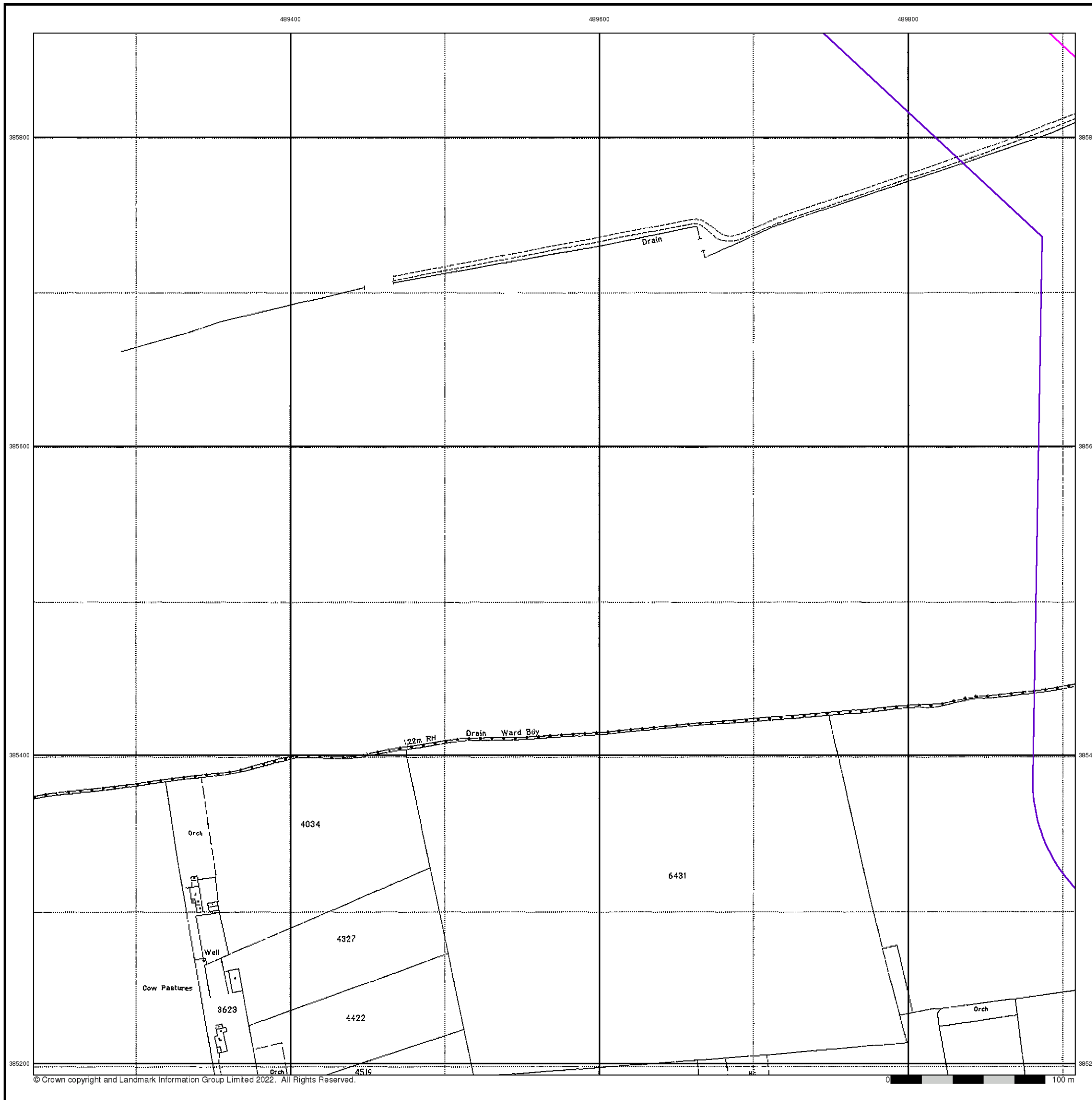

Historical Mapping Legends

Ordnance Survey County Series and Ordnance Survey Plan 1:2,500

Quarry **Gravel Pit** **Sand Pit**
Clay Pit **Shingle** **Refuse Heap**
Sloping Masonry **Flat Rock**
Marsh **Reeds** **Osiers**
Rough Pasture **Furze** **Wood**
Mixed Wood **Brushwood** **Orchard**
Fir **Ford** **Stepping Stones**
Ferry **Waterfall** **Lock**
Trig. Station **Altitude at Trig. Station**
B.M. 325.9 **Bench Mark** **Surface Level**
Arrow denotes flow of water **Antiquities (site of)**
Cutting **Embankment**
Railway crossing Road **Level Crossing** **Road crossing Railway**
Railway crossing River or Canal **Road over single stream** **Road over River or Canal**
County Boundary (Geographical)
County & Civil Parish Boundary
Administrative County & Civil Parish Boundary
County Borough Boundary (England)
County Burgh Boundary (Scotland)
Co. Boro. Bdy.
Co. Burgh Bdy.
BP BS Boundary Post or Stone **P.C.B** Police Call Box
B.R. Bridle Road **P** Pump
E.P Electricity Pylon **S.P** Signal Post
F.B. Foot Bridge **SL** Sluice
F.P. Foot Path **Sp.** Spring
G.P Guide Post or Board **T.C.B** Telephone Call Box
M.S Mile Stone **Tr.** Trough
M.P M.R Mooring Post or Ring **W** Well

Ordnance Survey Plan, Additional SIMs and Supply of Unpublished Survey Information 1:2,500 and 1:1,250

Inactive Quarry, Chalk Pit or Clay Pit **Active Quarry, Chalk Pit or Clay Pit**
Rock **Boulders**
Cliff **Slopes** **Top**
Roofed Building **Glazed Roof Building**
Sloping Masonry **Archway**
Non-Coniferous Tree (surveyed) **Coniferous Tree (surveyed)**
Non-Coniferous Trees (not surveyed) **Coniferous Trees (not surveyed)**
Orchard Tree **Scrub** **Bracken**
Coppice, Osier **Reeds** **Marsh, Saltings**
Rough Grassland **Heath** **Culvert**
Direction of water flow **Bench Mark** **Antiquity (site of)**
Cave Entrance **Triangulation Station** **Electricity Pylon**
Electricity Transmission Line
County Boundary (Geographical)
County & Civil Parish Boundary
Civil Parish Boundary
Admin. County or County Bor. Boundary
London Borough Boundary
Symbol marking point where boundary mereing changes
BH Beer House **P** Pillar, Pole or Post
BP, BS Boundary Post or Stone **PO** Post Office
Cn, C Capstan, Crane **PC** Public Convenience
Chy Chimney **PH** Public House
D Fn Drinking Fountain **Pp** Pump
EI P Electricity Pillar or Post **SB, S Br** Signal Box or Bridge
FAP Fire Alarm Pillar **SP, SL** Signal Post or Light
FB Foot Bridge **Spr** Spring
GP Guide Post **Tk** Tank or Track
H Hydrant or Hydraulic **TCB** Telephone Call Box
LC Level Crossing **TCP** Telephone Call Post
MH Manhole **Tr** Trough
MP Mile Post or Mooring Post **Wr Pt, Wr T** Water Point, Water Tap
MS Mile Stone **W** Well
NTL Normal Tidal Limit **Wd Pp** Wind Pump

Large-Scale National Grid Data 1:2,500 and 1:1,250

Cliff **Slopes** **Top**
Rock **Rock (scattered)**
Boulders **Boulders (scattered)**
Positioned Boulder **Scree**
Non-Coniferous Tree (surveyed) **Coniferous Tree (surveyed)**
Non-Coniferous Trees (not surveyed) **Coniferous Trees (not surveyed)**
Orchard Tree **Scrub** **Bracken**
Coppice, Osier **Reeds** **Marsh, Saltings**
Rough Grassland **Heath** **Culvert**
Direction of water flow **Triangulation Station** **Antiquity (site of)**
Electricity Transmission Line **Electricity Pylon**
B.M. 231.60m Bench Mark **Buildings with Building Seed**
Roofed Building **Glazed Roof Building**
Civil parish/community boundary
District boundary
County boundary
Boundary post/stone
Boundary mereing symbol (note: these always appear in opposed pairs or groups of three)
Bks Barracks **P** Pillar, Pole or Post
Bty Battery **PO** Post Office
Cemy Cemetery **PC** Public Convenience
Chy Chimney **Pp** Pump
Cis Cistern **Ppg Sta** Pumping Station
Dismtd Rly Dismantled Railway **PW** Place of Worship
EI Gen Sta Electricity Generating Station **Sewage Ppg Sta** Sewage Pumping Station
EI P Electricity Pole, Pillar **SB, S Br** Signal Box or Bridge
EI Sub Sta Electricity Sub Station **SP, SL** Signal Post or Light
FB Filter Bed **Spr** Spring
Fn / D Fn Fountain / Drinking Ftn. **Tk** Tank or Track
Gas Gov Gas Valve Compound **Tr** Trough
GVC Gas Governor **Wd Pp** Wind Pump
GP Guide Post **Wr Pt, Wr T** Water Point, Water Tap
MH Manhole **Wks** Works (building or area)
MP, MS Mile Post or Mile Stone **W** Well



Historical Mapping & Photography included:

Mapping Type	Scale	Date	Pg
Lincolnshire	1:2,500	1886	2
Lincolnshire	1:2,500	1906	3
Ordnance Survey Plan	1:2,500	1972 - 1974	4
Large-Scale National Grid Data	1:2,500	1994	5

Historical Map - Segment C11

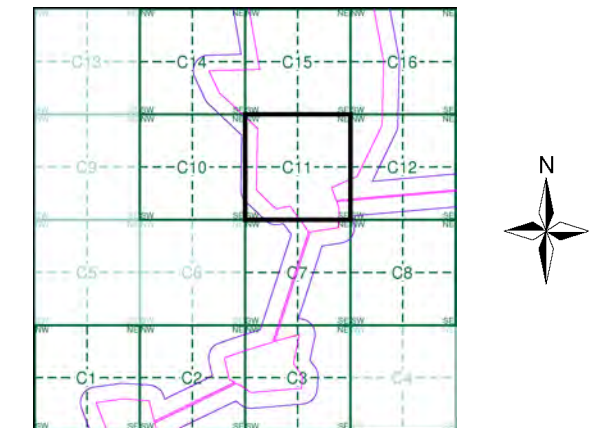

Order Details

Order Number: 297990273_1_1
 Customer Ref: 21-1088.04
 National Grid Reference: 490170, 385250
 Slice: C
 Site Area (Ha): 469.98
 Search Buffer (m): 100

Site Details

Cottam



Tel: [Redacted]
 Fax: [Redacted]
 Web: [Redacted]

Lincolnshire

Published 1886

Source map scale - 1:2,500

The historical maps shown were reproduced from maps predominantly held at the scale adopted for England, Wales and Scotland in the 1840's. In 1854 the 1:2,500 scale was adopted for mapping urban areas and by 1896 it covered the whole of what were considered to be the cultivated parts of Great Britain. The published date given below is often some years later than the surveyed date. Before 1938, all OS maps were based on the Cassini Projection, with independent surveys of a single county or group of counties, giving rise to significant inaccuracies in outlying areas.

Map Name(s) and Date(s)

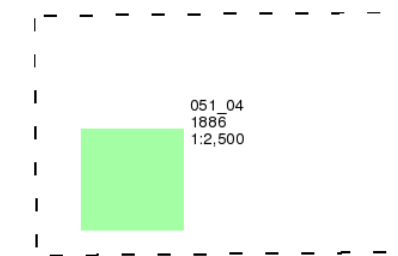

Historical Map - Segment C11

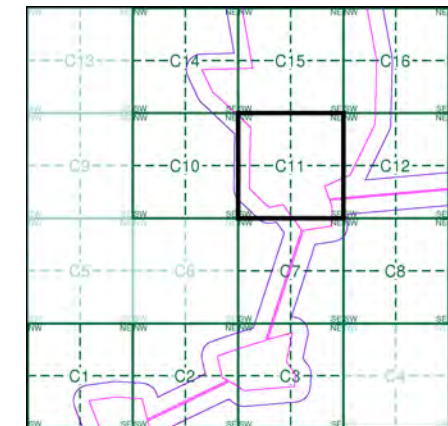

Order Details

Order Number: 297990273_1_1
 Customer Ref: 21-1088.04
 National Grid Reference: 490170, 385250
 Slice: C
 Site Area (Ha): 469.98
 Search Buffer (m): 100

Site Details

Cottam

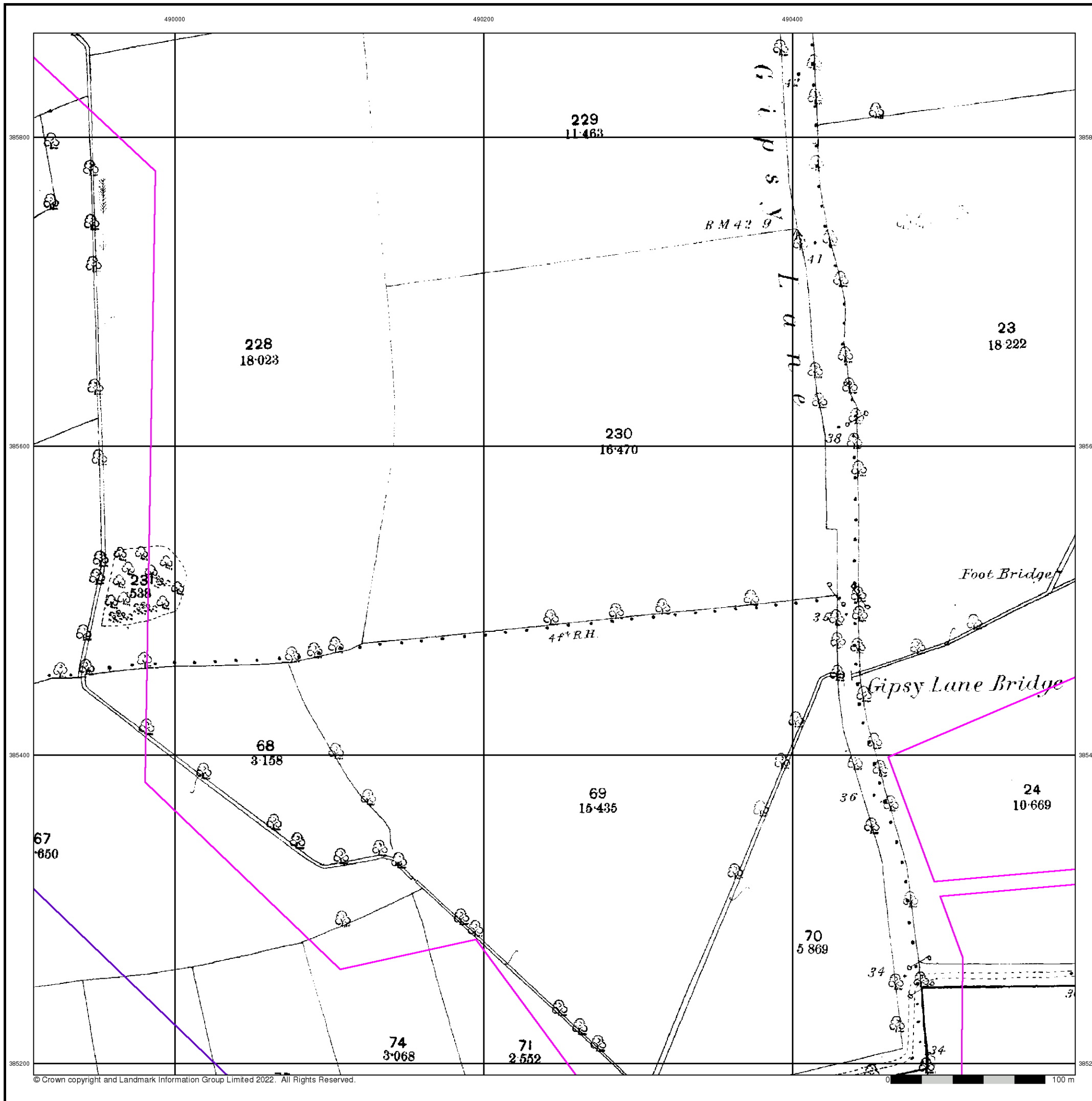

Lincolnshire

Published 1906

Source map scale - 1:2,500

The historical maps shown were reproduced from maps predominantly held at the scale adopted for England, Wales and Scotland in the 1840's. In 1854 the 1:2,500 scale was adopted for mapping urban areas and by 1896 it covered the whole of what were considered to be the cultivated parts of Great Britain. The published date given below is often some years later than the surveyed date. Before 1938, all OS maps were based on the Cassini Projection, with independent surveys of a single county or group of counties, giving rise to significant inaccuracies in outlying areas.

Map Name(s) and Date(s)

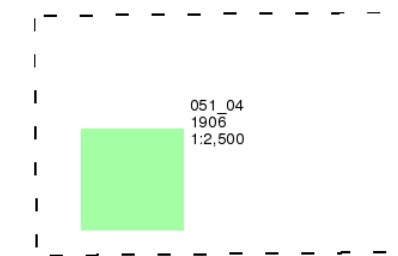

Historical Map - Segment C11

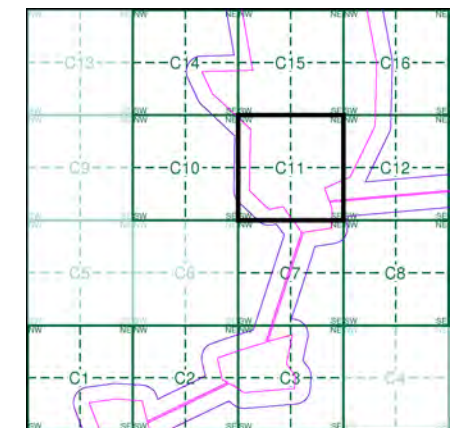

Order Details

Order Number: 297990273_1_1
 Customer Ref: 21-1088.04
 National Grid Reference: 490170, 385250
 Slice: C
 Site Area (Ha): 469.98
 Search Buffer (m): 100

Site Details

Cottam

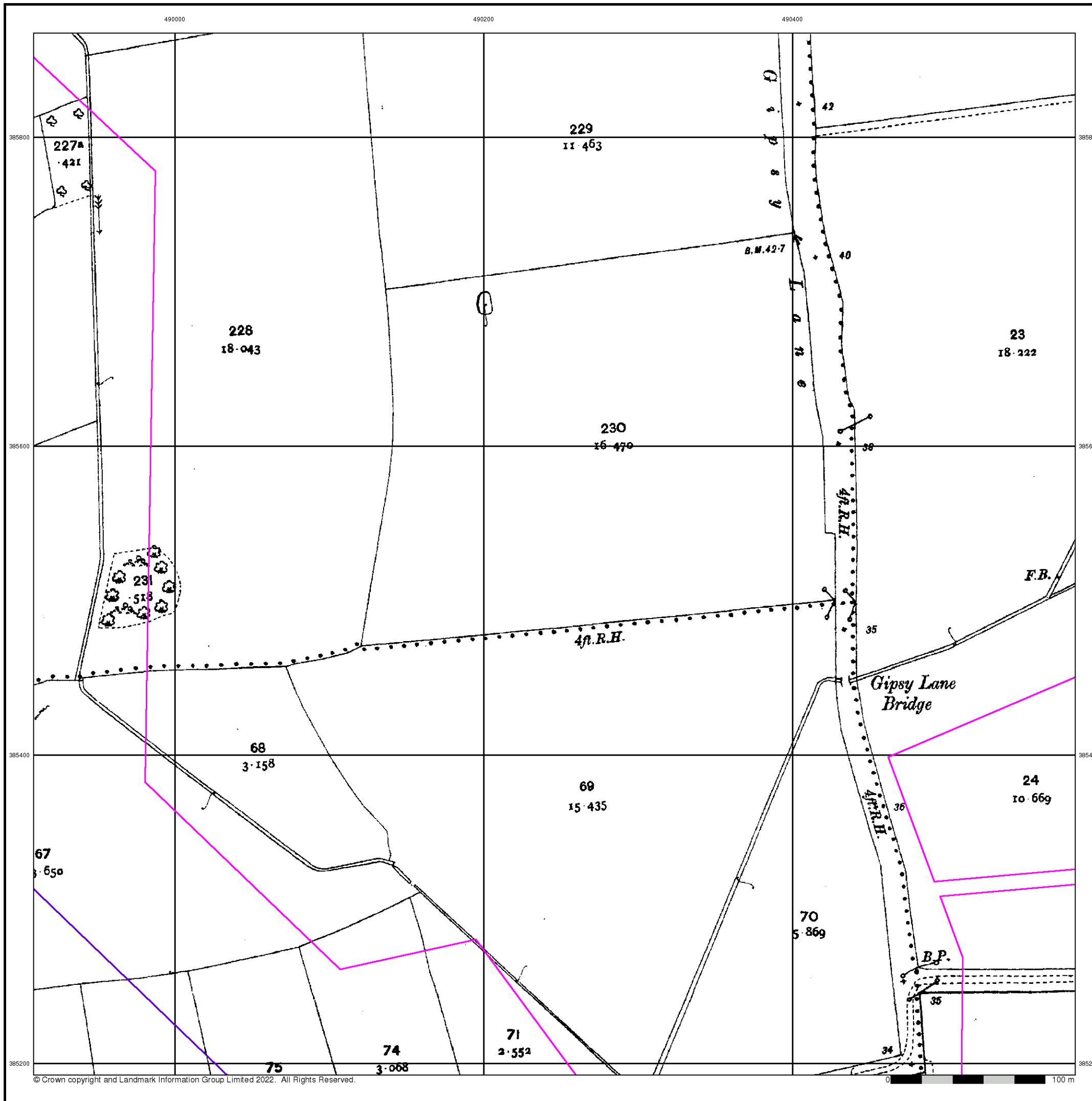

Ordnance Survey Plan

Published 1972 - 1974

Source map scale - 1:2,500

The historical maps shown were reproduced from maps predominantly held at the scale adopted for England, Wales and Scotland in the 1840's. In 1854 the 1:2,500 scale was adopted for mapping urban areas and by 1896 it covered the whole of what were considered to be the cultivated parts of Great Britain. The published date given below is often some years later than the surveyed date. Before 1938, all OS maps were based on the Cassini Projection, with independent surveys of a single county or group of counties, giving rise to significant inaccuracies in outlying areas.

Map Name(s) and Date(s)

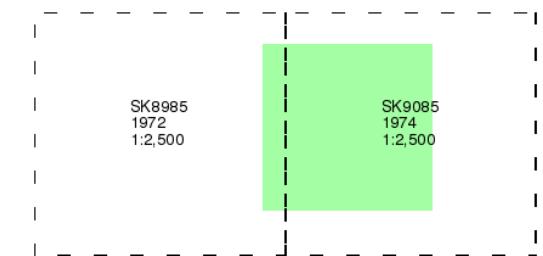

Historical Map - Segment C11

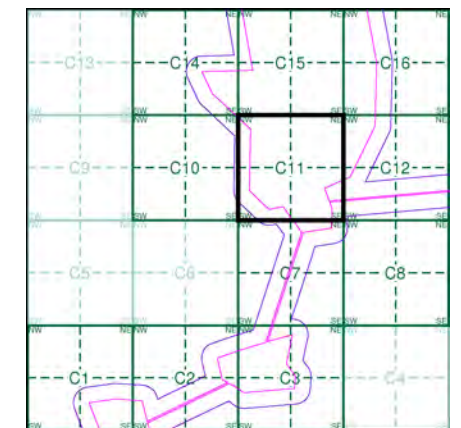

Order Details

Order Number: 297990273_1_1
 Customer Ref: 21-1088.04
 National Grid Reference: 490170, 385250
 Slice: C
 Site Area (Ha): 469.98
 Search Buffer (m): 100

Site Details

Cottam

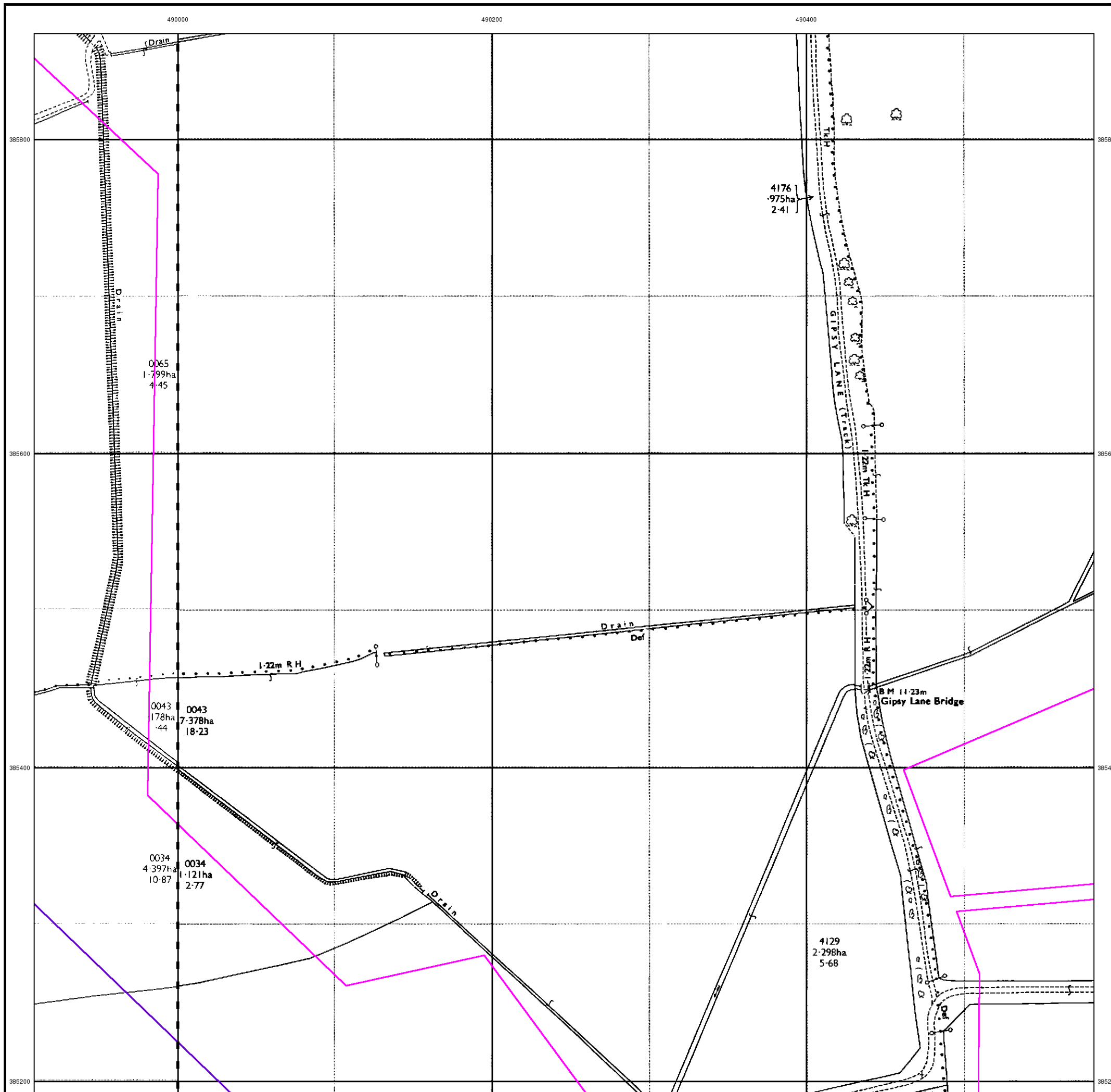

Large-Scale National Grid Data

Published 1994

Source map scale - 1:2,500

'Large Scale National Grid Data' superseded SIM cards (Ordnance Survey's 'Survey of Information on Microfilm') in 1992, and continued to be produced until 1999. These maps were the fore-runners of digital mapping and so provide detailed information on houses and roads, but tend to show less topographic features such as vegetation. These maps were produced at both 1:2,500 and 1:1,250 scales.

Map Name(s) and Date(s)

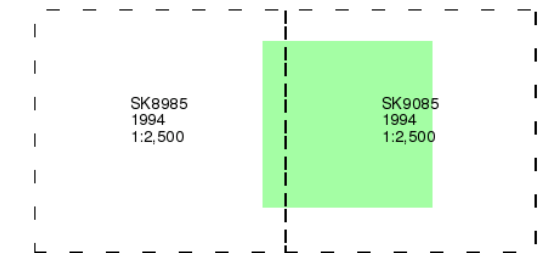

Historical Map - Segment C11

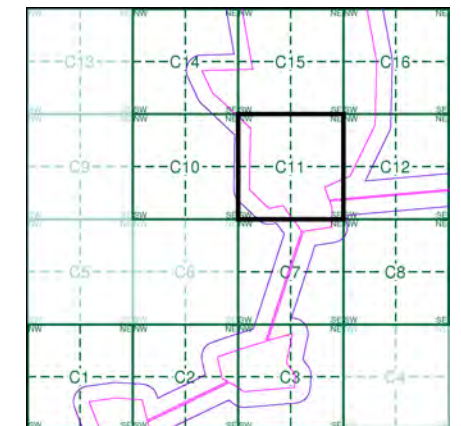

Order Details

Order Number: 297990273_1_1
 Customer Ref: 21-1088.04
 National Grid Reference: 490170, 385250
 Slice: C
 Site Area (Ha): 469.98
 Search Buffer (m): 100

Site Details

Cottam

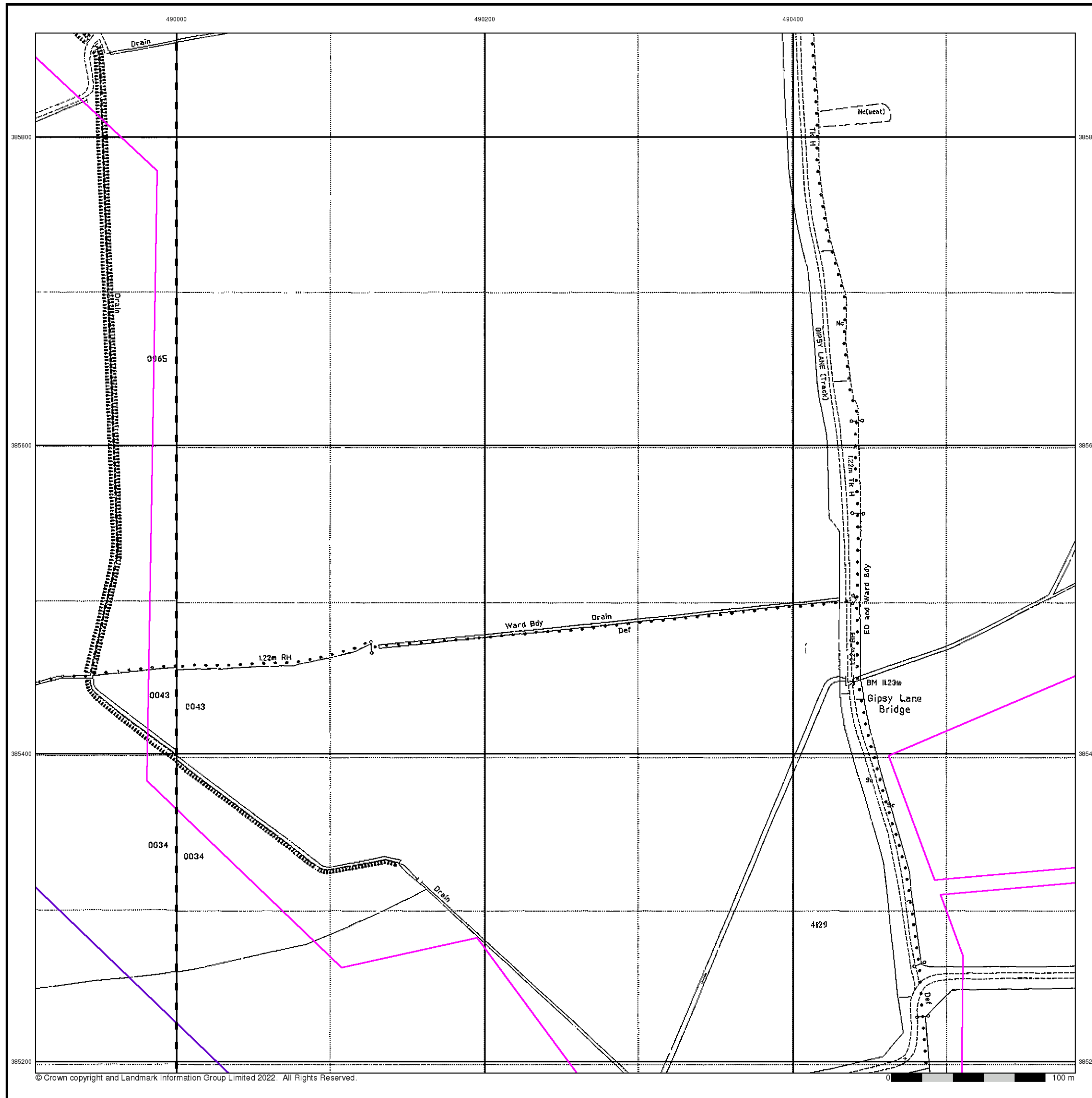

Historical Mapping Legends

Ordnance Survey County Series and Ordnance Survey Plan 1:2,500

Quarry **Gravel Pit** **Sand Pit**
Clay Pit **Shingle** **Refuse Heap**
Sloping Masonry **Flat Rock**
Marsh **Reeds** **Osiers**
Rough Pasture **Furze** **Wood**
Mixed Wood **Brushwood** **Orchard**
Fir **Ford** **Stepping Stones**
Ferry **Waterfall** **Lock**
Trig. Station **Altitude at Trig. Station**
B.M. 325.9 **Bench Mark** **Surface Level**
Arrow denotes flow of water **Antiquities (site of)**
Cutting **Embankment**
Railway crossing Road **Level Crossing** **Road crossing Railway**
Railway crossing River or Canal **Road over single stream** **Road over River or Canal**
County Boundary (Geographical)
County & Civil Parish Boundary
Administrative County & Civil Parish Boundary
County Borough Boundary (England)
County Burgh Boundary (Scotland)
Co. Boro. Bdy.
Co. Burgh Bdy.
BP BS Boundary Post or Stone **P.C.B** Police Call Box
B.R. Bridle Road **P** Pump
E.P Electricity Pylon **S.P** Signal Post
F.B. Foot Bridge **SL** Sluice
F.P. Foot Path **Sp.** Spring
G.P Guide Post or Board **T.C.B** Telephone Call Box
M.S Mile Stone **Tr.** Trough
M.P M.R Mooring Post or Ring **W** Well

Ordnance Survey Plan, Additional SIMs and Supply of Unpublished Survey Information 1:2,500 and 1:1,250

Inactive Quarry, Chalk Pit or Clay Pit **Active Quarry, Chalk Pit or Clay Pit**
Rock **Boulders**
Cliff **Slopes** **Top**
Roofed Building **Glazed Roof Building**
Sloping Masonry **Archway**
Non-Coniferous Tree (surveyed) **Coniferous Tree (surveyed)**
Non-Coniferous Trees (not surveyed) **Coniferous Trees (not surveyed)**
Orchard Tree **Scrub** **Bracken**
Coppice, Osier **Reeds** **Marsh, Saltings**
Rough Grassland **Heath** **Culvert**
Direction of water flow **Bench Mark** **Antiquity (site of)**
Cave Entrance **Triangulation Station** **Electricity Pylon**
Electricity Transmission Line
County Boundary (Geographical)
County & Civil Parish Boundary
Civil Parish Boundary
Admin. County or County Bor. Boundary
London Borough Boundary
Symbol marking point where boundary mereing changes
BH Beer House **P** Pillar, Pole or Post
BP, BS Boundary Post or Stone **PO** Post Office
Cn, C Capstan, Crane **PC** Public Convenience
Chy Chimney **PH** Public House
D Fn Drinking Fountain **Pp** Pump
EI P Electricity Pillar or Post **SB, S Br** Signal Box or Bridge
FAP Fire Alarm Pillar **SP, SL** Signal Post or Light
FB Foot Bridge **Spr** Spring
GP Guide Post **Tk** Tank or Track
H Hydrant or Hydraulic **TCB** Telephone Call Box
LC Level Crossing **TCP** Telephone Call Post
MH Manhole **Tr** Trough
MP Mile Post or Mooring Post **Wr Pt, Wr T** Water Point, Water Tap
MS Mile Stone **W** Well
NTL Normal Tidal Limit **Wd Pp** Wind Pump

Large-Scale National Grid Data 1:2,500 and 1:1,250

Cliff **Slopes** **Top**
Rock **Rock (scattered)**
Boulders **Boulders (scattered)**
Positioned Boulder **Scree**
Non-Coniferous Tree (surveyed) **Coniferous Tree (surveyed)**
Non-Coniferous Trees (not surveyed) **Coniferous Trees (not surveyed)**
Orchard Tree **Scrub** **Bracken**
Coppice, Osier **Reeds** **Marsh, Saltings**
Rough Grassland **Heath** **Culvert**
Direction of water flow **Triangulation Station** **Antiquity (site of)**
Electricity Transmission Line **Electricity Pylon**
B.M. 231.60m Bench Mark **Buildings with Building Seed**
Roofed Building **Glazed Roof Building**
Civil parish/community boundary
District boundary
County boundary
Boundary post/stone
Boundary mereing symbol (note: these always appear in opposed pairs or groups of three)
Bks Barracks **P** Pillar, Pole or Post
Bty Battery **PO** Post Office
Cemy Cemetery **PC** Public Convenience
Chy Chimney **Pp** Pump
Cis Cistern **Ppg Sta** Pumping Station
Dismtd Rly Dismantled Railway **PW** Place of Worship
EI Gen Sta Electricity Generating Station **Sewage Ppg Sta** Sewage Pumping Station
EI P Electricity Pole, Pillar **SB, S Br** Signal Box or Bridge
EI Sub Sta Electricity Sub Station **SP, SL** Signal Post or Light
FB Filter Bed **Spr** Spring
Fn / D Fn Fountain / Drinking Ftn. **Tk** Tank or Track
Gas Gov Gas Valve Compound **Tr** Trough
GVC Gas Governor **Wd Pp** Wind Pump
GP Guide Post **Wr Pt, Wr T** Water Point, Water Tap
MH Manhole **Wks** Works (building or area)
MP, MS Mile Post or Mile Stone **W** Well



Historical Mapping & Photography included:

Mapping Type	Scale	Date	Pg
Lincolnshire	1:2,500	1886	2
Lincolnshire	1:2,500	1906	3
Ordnance Survey Plan	1:2,500	1974	4
Large-Scale National Grid Data	1:2,500	1994	5

Historical Map - Segment C12

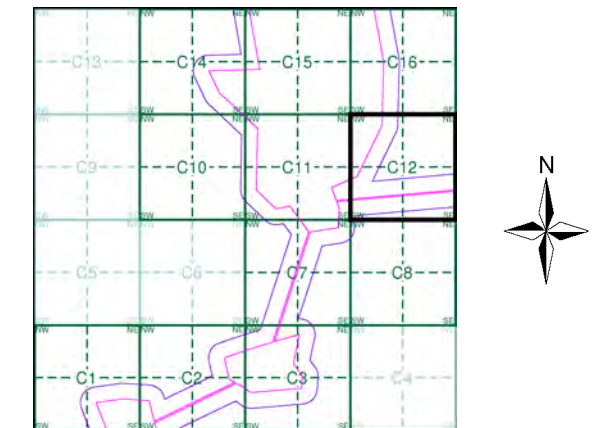

Order Details

Order Number: 297990273_1_1
 Customer Ref: 21-1088.04
 National Grid Reference: 490170, 385250
 Slice: C
 Site Area (Ha): 469.98
 Search Buffer (m): 100

Site Details

Cottam



Tel:
Fax:
Web:

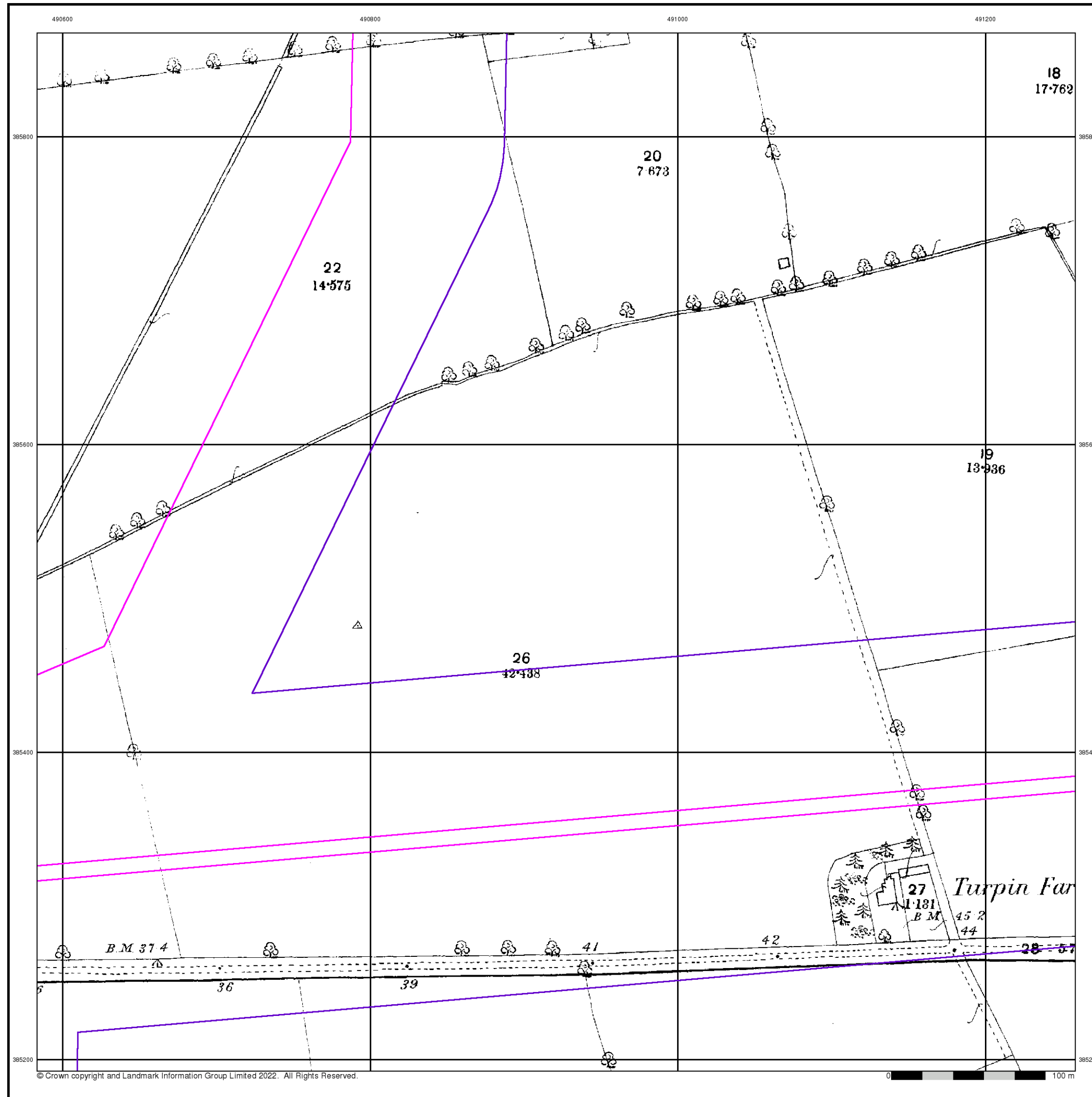

Lincolnshire
Published 1886

Source map scale - 1:2,500

The historical maps shown were reproduced from maps predominantly held at the scale adopted for England, Wales and Scotland in the 1840's. In 1854 the 1:2,500 scale was adopted for mapping urban areas and by 1896 it covered the whole of what were considered to be the cultivated parts of Great Britain. The published date given below is often some years later than the surveyed date. Before 1938, all OS maps were based on the Cassini Projection, with independent surveys of a single county or group of counties, giving rise to significant inaccuracies in outlying areas.

Map Name(s) and Date(s)

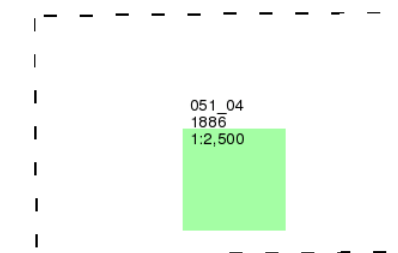

Historical Map - Segment C12

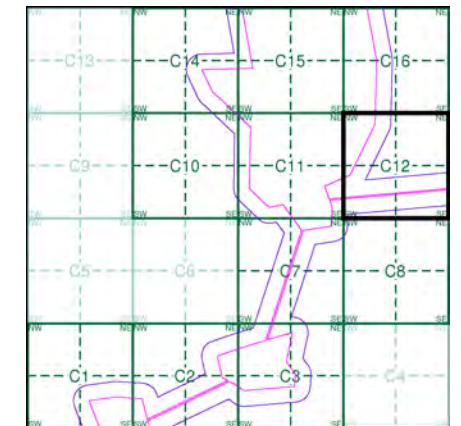

Order Details

Order Number: 297990273_1_1
 Customer Ref: 21-1088.04
 National Grid Reference: 490170, 385250
 Slice: C
 Site Area (Ha): 469.98
 Search Buffer (m): 100

Site Details

Cottam



Tel: [Redacted]
 Fax: [Redacted]
 Web: [Redacted]

Lincolnshire

Published 1906

Source map scale - 1:2,500

The historical maps shown were reproduced from maps predominantly held at the scale adopted for England, Wales and Scotland in the 1840's. In 1854 the 1:2,500 scale was adopted for mapping urban areas and by 1896 it covered the whole of what were considered to be the cultivated parts of Great Britain. The published date given below is often some years later than the surveyed date. Before 1938, all OS maps were based on the Cassini Projection, with independent surveys of a single county or group of counties, giving rise to significant inaccuracies in outlying areas.

Map Name(s) and Date(s)

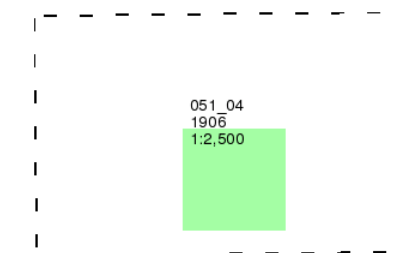

Historical Map - Segment C12

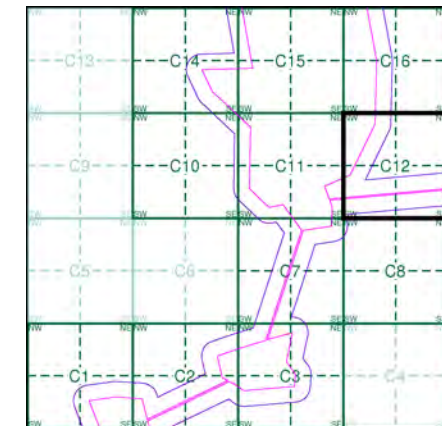

Order Details

Order Number: 297990273_1_1
 Customer Ref: 21-1088.04
 National Grid Reference: 490170, 385250
 Slice: C
 Site Area (Ha): 469.98
 Search Buffer (m): 100

Site Details

Cottam

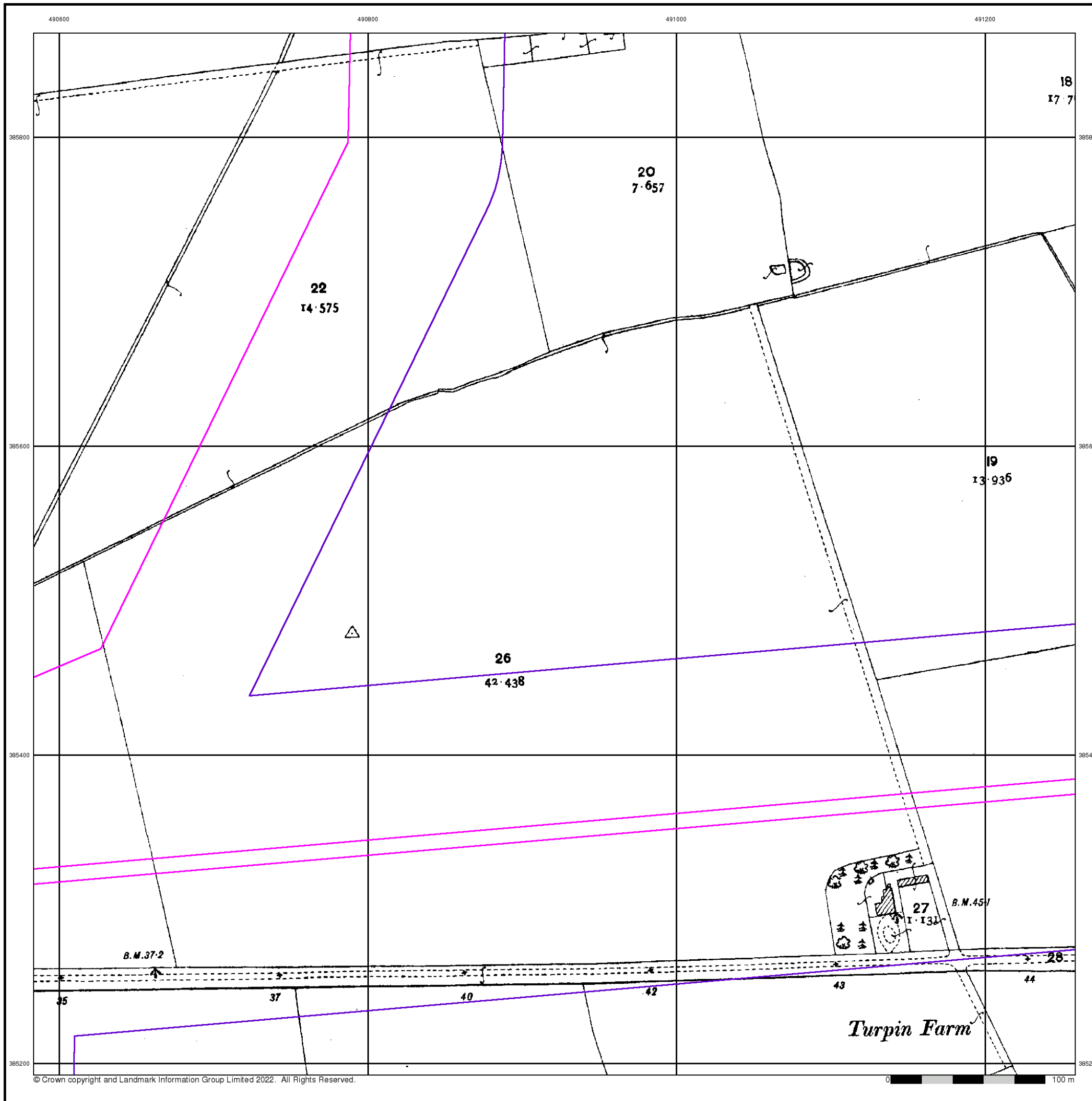

Ordnance Survey Plan

Published 1974

Source map scale - 1:2,500

The historical maps shown were reproduced from maps predominantly held at the scale adopted for England, Wales and Scotland in the 1840's. In 1854 the 1:2,500 scale was adopted for mapping urban areas and by 1896 it covered the whole of what were considered to be the cultivated parts of Great Britain. The published date given below is often some years later than the surveyed date. Before 1938, all OS maps were based on the Cassini Projection, with independent surveys of a single county or group of counties, giving rise to significant inaccuracies in outlying areas.

Map Name(s) and Date(s)

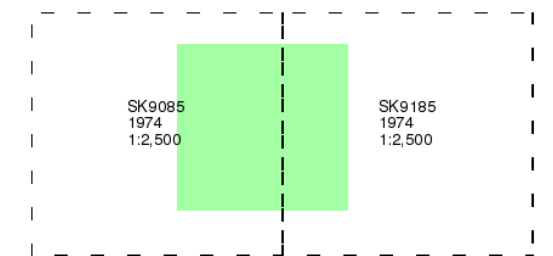

Historical Map - Segment C12

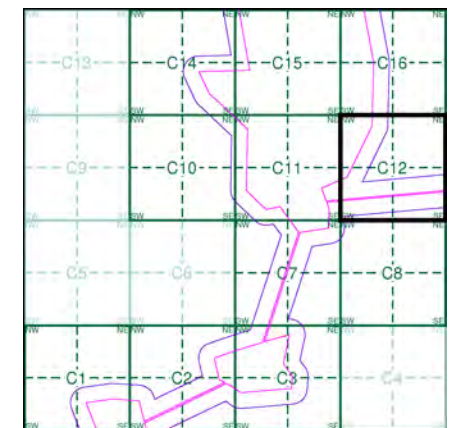

Order Details

Order Number: 297990273_1_1
 Customer Ref: 21-1088.04
 National Grid Reference: 490170, 385250
 Slice: C
 Site Area (Ha): 469.98
 Search Buffer (m): 100

Site Details

Cottam

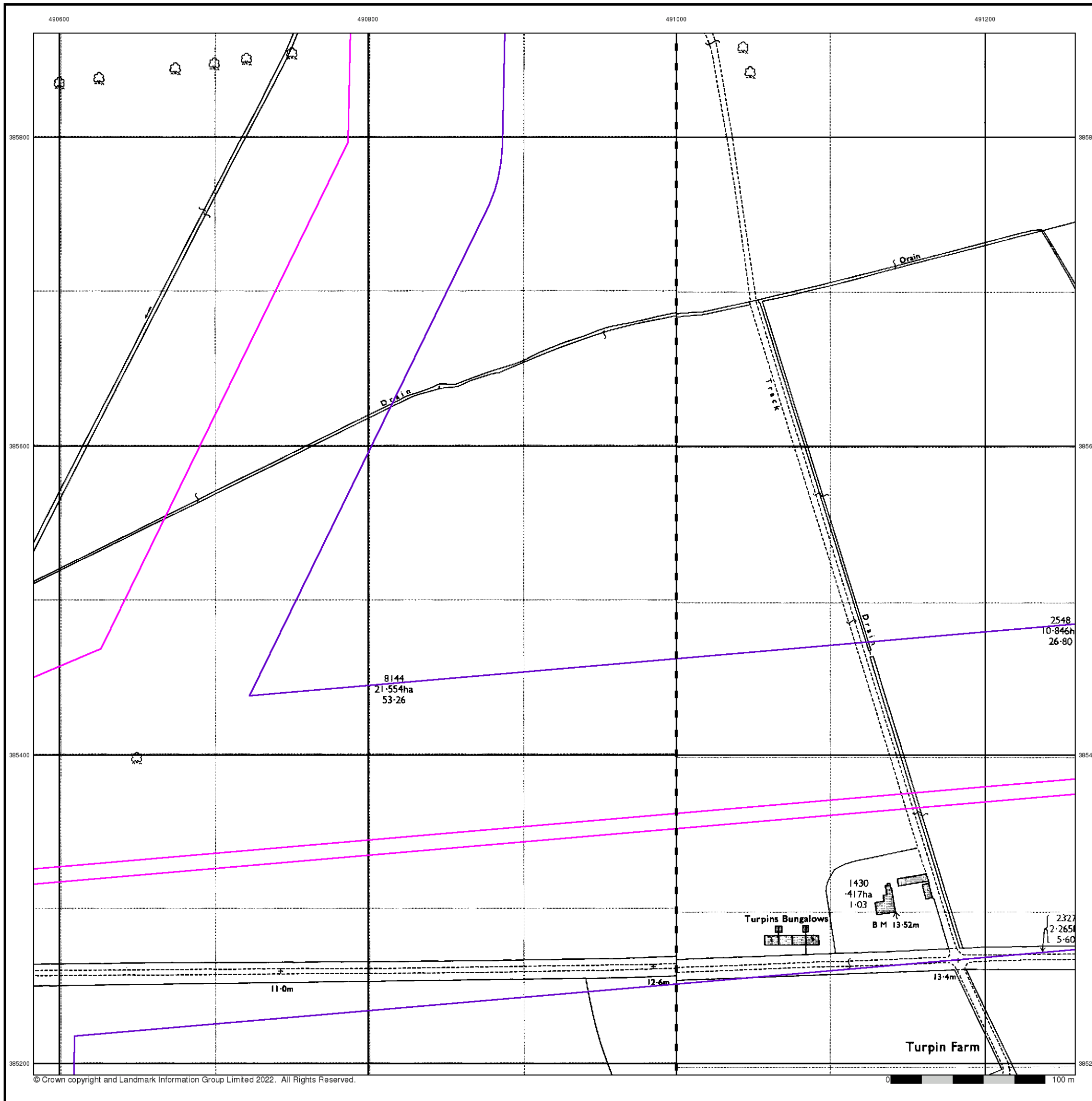

Large-Scale National Grid Data

Published 1994

Source map scale - 1:2,500

'Large Scale National Grid Data' superseded SIM cards (Ordnance Survey's 'Survey of Information on Microfilm') in 1992, and continued to be produced until 1999. These maps were the fore-runners of digital mapping and so provide detailed information on houses and roads, but tend to show less topographic features such as vegetation. These maps were produced at both 1:2,500 and 1:1,250 scales.

Map Name(s) and Date(s)

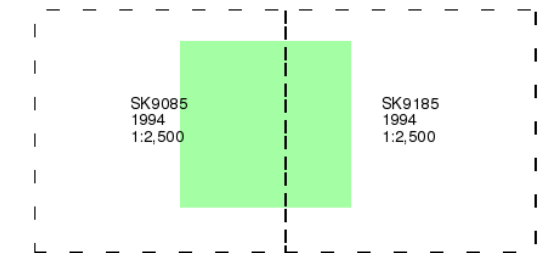

Historical Map - Segment C12

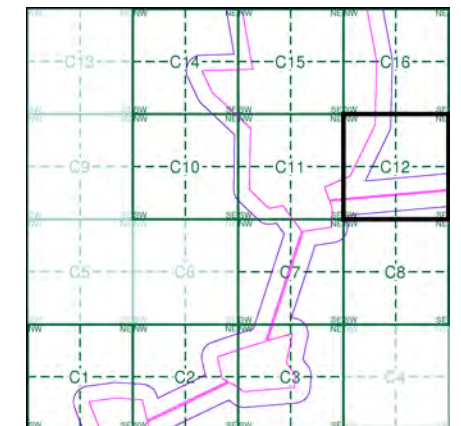

Order Details

Order Number: 297990273_1_1
 Customer Ref: 21-1088.04
 National Grid Reference: 490170, 385250
 Slice: C
 Site Area (Ha): 469.98
 Search Buffer (m): 100

Site Details

Cottam

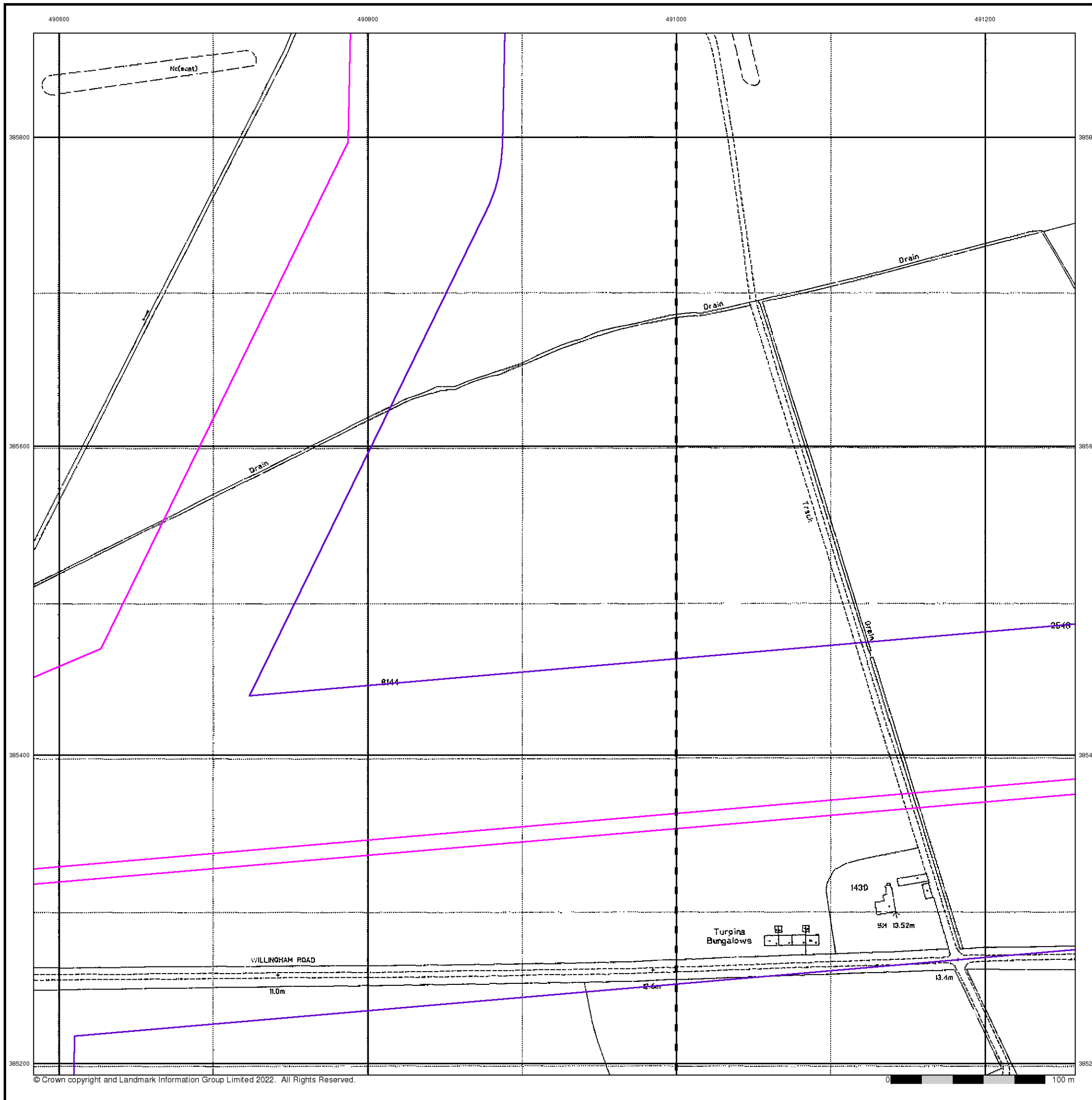

Historical Mapping Legends

Ordnance Survey County Series and Ordnance Survey Plan 1:2,500

Quarry **Gravel Pit** **Sand Pit**
Clay Pit **Shingle** **Refuse Heap**
Sloping Masonry **Flat Rock**
Marsh **Reeds** **Osiers**
Rough Pasture **Furze** **Wood**
Mixed Wood **Brushwood** **Orchard**
Fir **Ford** **Stepping Stones**
Ferry **Waterfall** **Lock**
Trig. Station **Altitude at Trig. Station**
B.M. 325.9 **Bench Mark** **Surface Level**
Arrow denotes flow of water **Antiquities (site of)**
Cutting **Embankment**
Railway crossing Road **Level Crossing** **Road crossing Railway**
Railway crossing River or Canal **Road over single stream** **Road over River or Canal**
County Boundary (Geographical)
County & Civil Parish Boundary
Administrative County & Civil Parish Boundary
County Borough Boundary (England)
County Burgh Boundary (Scotland)
Co. Boro. Bdy.
Co. Burgh Bdy.
BP BS Boundary Post or Stone **P.C.B** Police Call Box
B.R. Bridle Road **P** Pump
E.P Electricity Pylon **S.P** Signal Post
F.B. Foot Bridge **SL** Sluice
F.P. Foot Path **Sp.** Spring
G.P Guide Post or Board **T.C.B** Telephone Call Box
M.S Mile Stone **Tr.** Trough
M.P M.R Mooring Post or Ring **W** Well

Ordnance Survey Plan, Additional SIMs and Supply of Unpublished Survey Information 1:2,500 and 1:1,250

Inactive Quarry, Chalk Pit or Clay Pit **Active Quarry, Chalk Pit or Clay Pit**
Rock **Boulders**
Cliff **Slopes** **Top**
Roofed Building **Glazed Roof Building**
Sloping Masonry **Archway**
Non-Coniferous Tree (surveyed) **Coniferous Tree (surveyed)**
Non-Coniferous Trees (not surveyed) **Coniferous Trees (not surveyed)**
Orchard Tree **Scrub** **Bracken**
Coppice, Osier **Reeds** **Marsh, Saltings**
Rough Grassland **Heath** **Culvert**
Direction of water flow **Bench Mark** **Antiquity (site of)**
Cave Entrance **Triangulation Station** **Electricity Pylon**
Electricity Transmission Line
County Boundary (Geographical)
County & Civil Parish Boundary
Civil Parish Boundary
Admin. County or County Bor. Boundary
London Borough Boundary
Symbol marking point where boundary mereing changes
BH Beer House **P** Pillar, Pole or Post
BP, BS Boundary Post or Stone **PO** Post Office
Cn, C Capstan, Crane **PC** Public Convenience
Chy Chimney **PH** Public House
D Fn Drinking Fountain **Pp** Pump
EI P Electricity Pillar or Post **SB, S Br** Signal Box or Bridge
FAP Fire Alarm Pillar **SP, SL** Signal Post or Light
FB Foot Bridge **Spr** Spring
GP Guide Post **Tk** Tank or Track
H Hydrant or Hydraulic **TCB** Telephone Call Box
LC Level Crossing **TCP** Telephone Call Post
MH Manhole **Tr** Trough
MP Mile Post or Mooring Post **Wr Pt, Wr T** Water Point, Water Tap
MS Mile Stone **W** Well
NTL Normal Tidal Limit **Wd Pp** Wind Pump

Large-Scale National Grid Data 1:2,500 and 1:1,250

Cliff **Slopes** **Top**
Rock **Rock (scattered)**
Boulders **Boulders (scattered)**
Positioned Boulder **Scree**
Non-Coniferous Tree (surveyed) **Coniferous Tree (surveyed)**
Non-Coniferous Trees (not surveyed) **Coniferous Trees (not surveyed)**
Orchard Tree **Scrub** **Bracken**
Coppice, Osier **Reeds** **Marsh, Saltings**
Rough Grassland **Heath** **Culvert**
Direction of water flow **Triangulation Station** **Antiquity (site of)**
Electricity Transmission Line **Electricity Pylon**
B.M. 231.60m Bench Mark **Buildings with Building Seed**
Roofed Building **Glazed Roof Building**
Civil parish/community boundary
District boundary
County boundary
Boundary post/stone
Boundary mereing symbol (note: these always appear in opposed pairs or groups of three)
Bks Barracks **P** Pillar, Pole or Post
Bty Battery **PO** Post Office
Cemy Cemetery **PC** Public Convenience
Chy Chimney **Pp** Pump
Cis Cistern **Ppg Sta** Pumping Station
Dismtd Rly Dismantled Railway **PW** Place of Worship
EI Gen Sta Electricity Generating Station **Sewage Ppg Sta** Sewage Pumping Station
EI P Electricity Pole, Pillar **SB, S Br** Signal Box or Bridge
EI Sub Sta Electricity Sub Station **SP, SL** Signal Post or Light
FB Filter Bed **Spr** Spring
Fn / D Fn Fountain / Drinking Ftn. **Tk** Tank or Track
Gas Gov Gas Valve Compound **Tr** Trough
GVC Gas Governor **Wd Pp** Wind Pump
GP Guide Post **Wr Pt, Wr T** Water Point, Water Tap
MH Manhole **Wks** Works (building or area)
MP, MS Mile Post or Mile Stone **W** Well



Historical Mapping & Photography included:

Mapping Type	Scale	Date	Pg
Lincolnshire	1:2,500	1886	2
Lincolnshire	1:2,500	1906	3
Ordnance Survey Plan	1:2,500	1972	4
Large-Scale National Grid Data	1:2,500	1994	5

Historical Map - Segment C14

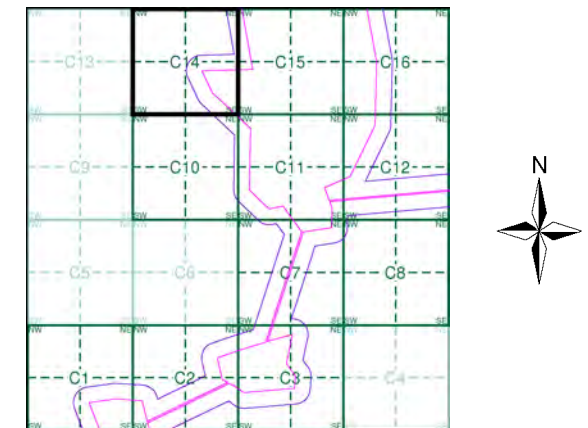

Order Details

Order Number: 297990273_1_1
 Customer Ref: 21-1088.04
 National Grid Reference: 490170, 385250
 Slice: C
 Site Area (Ha): 469.98
 Search Buffer (m): 100

Site Details

Cottam



Tel:
Fax:
Web:

Lincolnshire

Published 1886

Source map scale - 1:2,500

The historical maps shown were reproduced from maps predominantly held at the scale adopted for England, Wales and Scotland in the 1840's. In 1854 the 1:2,500 scale was adopted for mapping urban areas and by 1896 it covered the whole of what were considered to be the cultivated parts of Great Britain. The published date given below is often some years later than the surveyed date. Before 1938, all OS maps were based on the Cassini Projection, with independent surveys of a single county or group of counties, giving rise to significant inaccuracies in outlying areas.

Map Name(s) and Date(s)

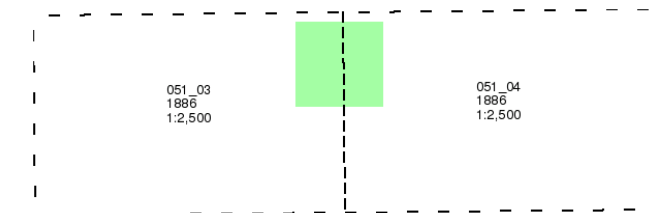

Historical Map - Segment C14

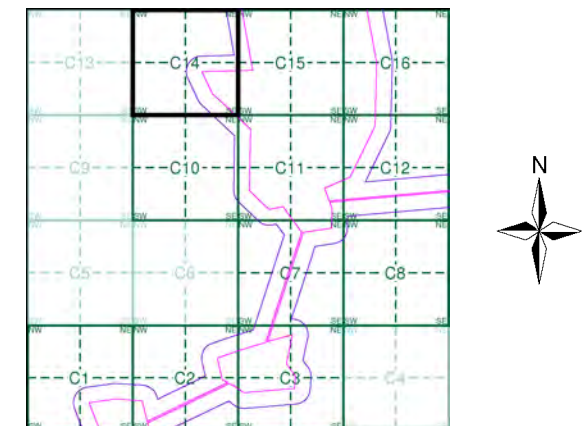

Order Details

Order Number: 297990273_1_1
 Customer Ref: 21-1088.04
 National Grid Reference: 490170, 385250
 Slice: C
 Site Area (Ha): 469.98
 Search Buffer (m): 100

Site Details

Cottam

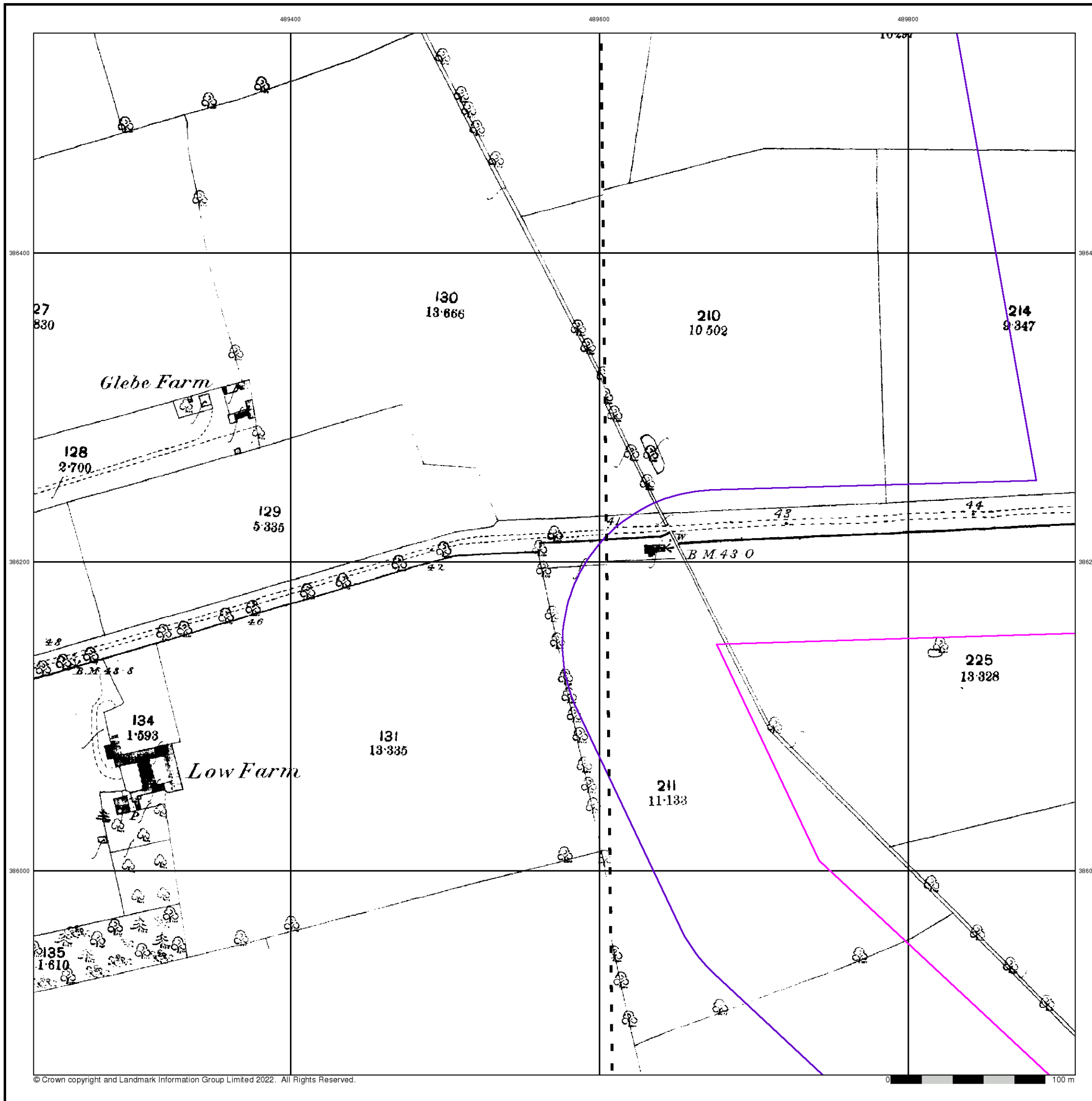

Lincolnshire

Published 1906

Source map scale - 1:2,500

The historical maps shown were reproduced from maps predominantly held at the scale adopted for England, Wales and Scotland in the 1840's. In 1854 the 1:2,500 scale was adopted for mapping urban areas and by 1896 it covered the whole of what were considered to be the cultivated parts of Great Britain. The published date given below is often some years later than the surveyed date. Before 1938, all OS maps were based on the Cassini Projection, with independent surveys of a single county or group of counties, giving rise to significant inaccuracies in outlying areas.

Map Name(s) and Date(s)

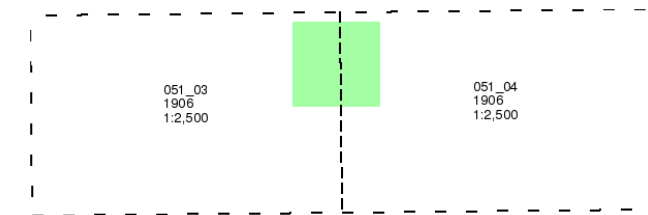

Historical Map - Segment C14

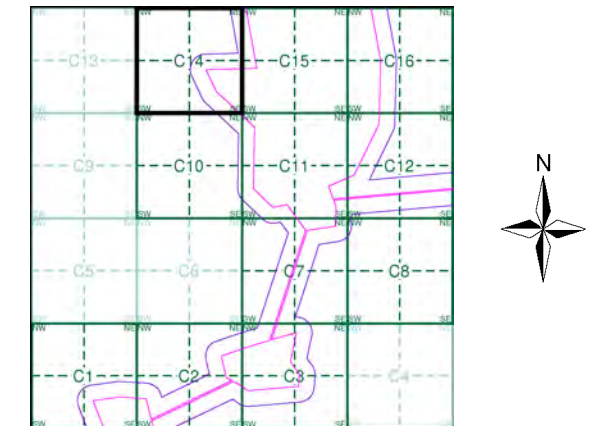

Order Details

Order Number: 297990273_1_1
 Customer Ref: 21-1088.04
 National Grid Reference: 490170, 385250
 Slice: C
 Site Area (Ha): 469.98
 Search Buffer (m): 100

Site Details

Cottam

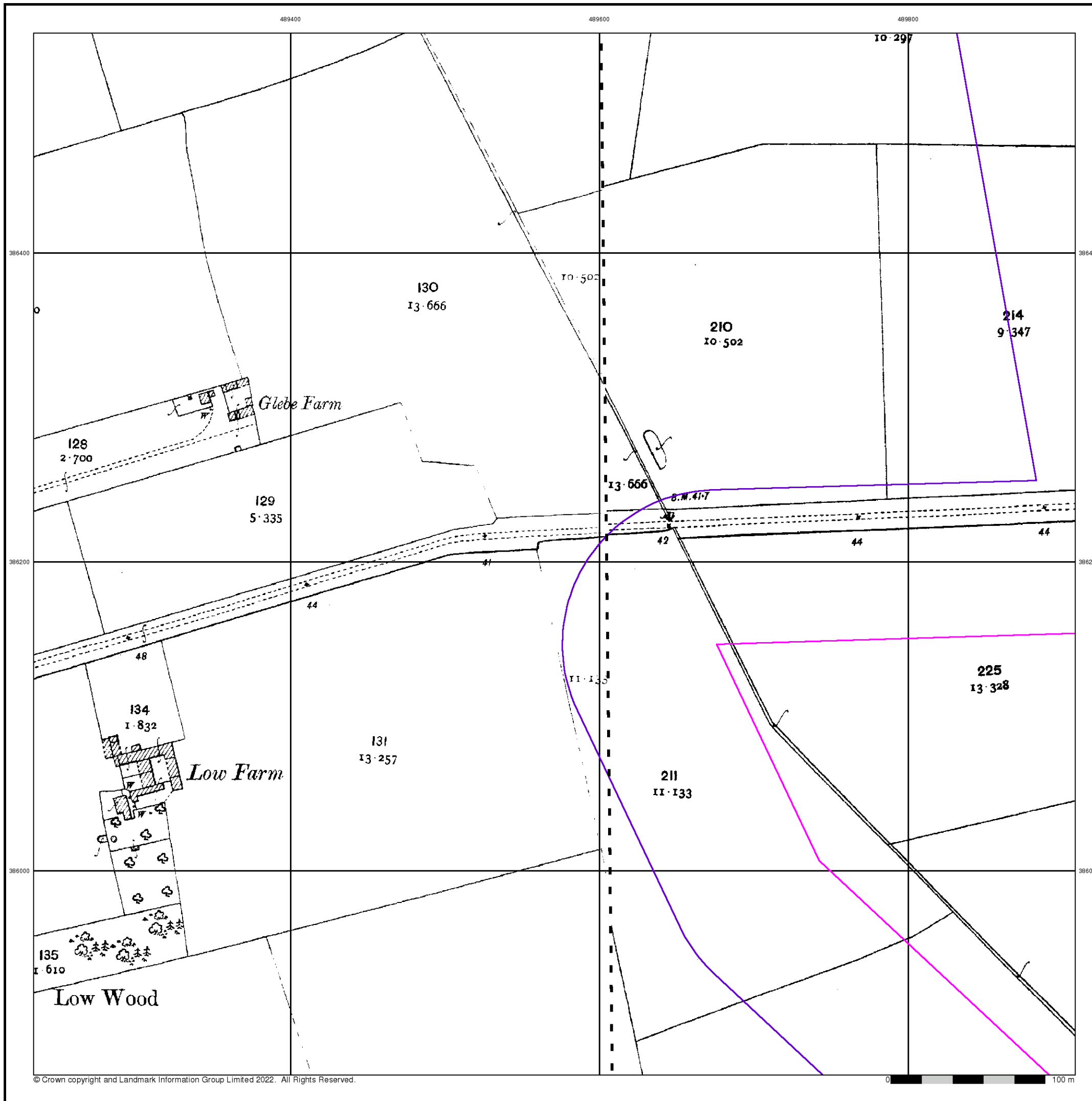

Ordnance Survey Plan

Published 1972

Source map scale - 1:2,500

The historical maps shown were reproduced from maps predominantly held at the scale adopted for England, Wales and Scotland in the 1840's. In 1854 the 1:2,500 scale was adopted for mapping urban areas and by 1896 it covered the whole of what were considered to be the cultivated parts of Great Britain. The published date given below is often some years later than the surveyed date. Before 1938, all OS maps were based on the Cassini Projection, with independent surveys of a single county or group of counties, giving rise to significant inaccuracies in outlying areas.

Map Name(s) and Date(s)

SK8986	1972	1:2,500
SK8985	1972	1:2,500

Historical Map - Segment C14

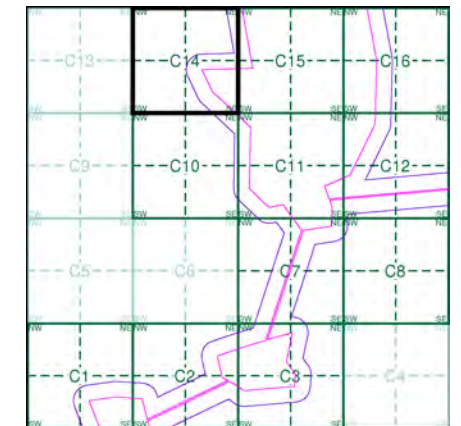

Order Details

Order Number: 297990273_1_1
 Customer Ref: 21-1088.04
 National Grid Reference: 490170, 385250
 Slice: C
 Site Area (Ha): 469.98
 Search Buffer (m): 100

Site Details

Cottam

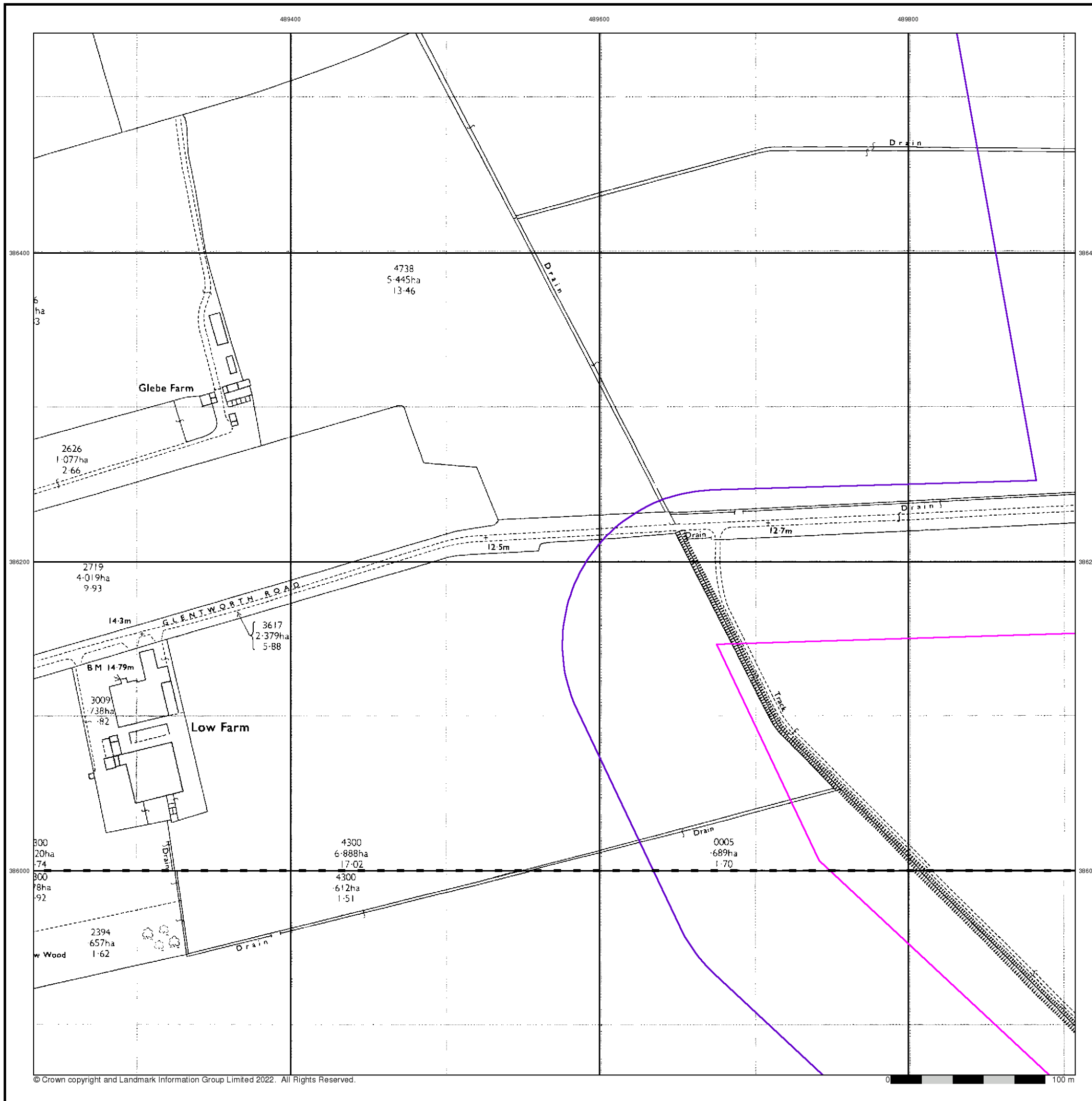

Large-Scale National Grid Data

Published 1994

Source map scale - 1:2,500

'Large Scale National Grid Data' superseded SIM cards (Ordnance Survey's 'Survey of Information on Microfilm') in 1992, and continued to be produced until 1999. These maps were the fore-runners of digital mapping and so provide detailed information on houses and roads, but tend to show less topographic features such as vegetation. These maps were produced at both 1:2,500 and 1:1,250 scales.

Map Name(s) and Date(s)

SK8986	1994	1:2,500
SK8985	1994	1:2,500

Historical Map - Segment C14

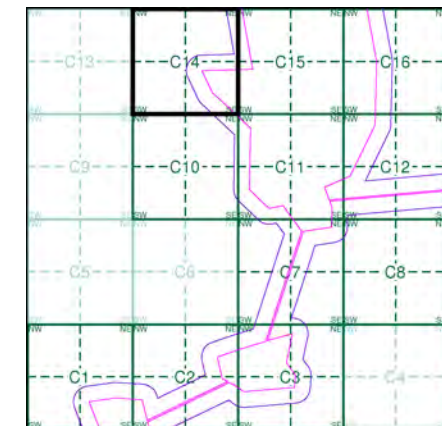

Order Details

Order Number: 297990273_1_1
 Customer Ref: 21-1088.04
 National Grid Reference: 490170, 385250
 Slice: C
 Site Area (Ha): 469.98
 Search Buffer (m): 100

Site Details

Cottam

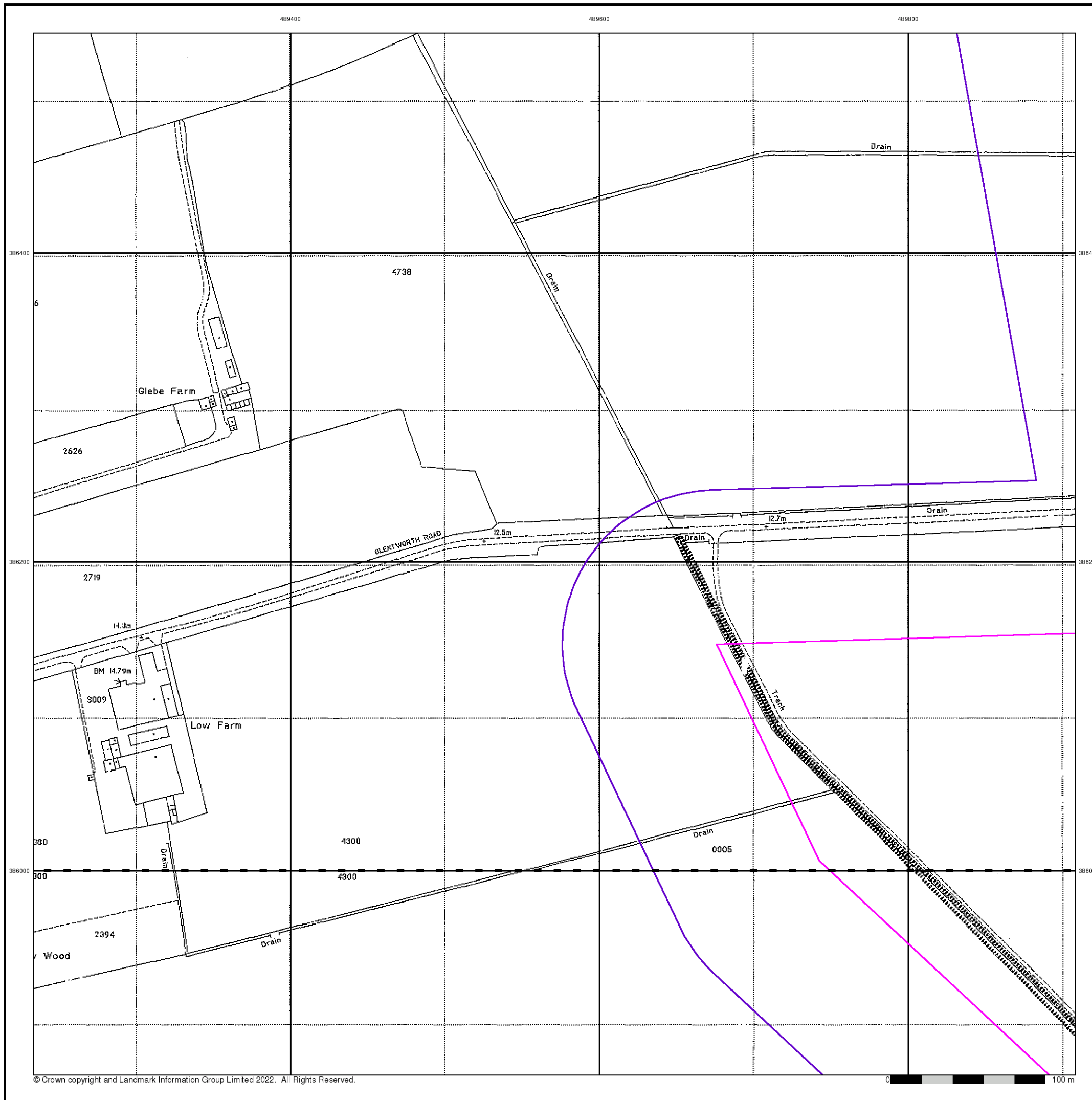

Historical Mapping Legends

Ordnance Survey County Series and Ordnance Survey Plan 1:2,500

Quarry **Gravel Pit** **Sand Pit**
Clay Pit **Shingle** **Refuse Heap**
Sloping Masonry **Flat Rock**
Marsh **Reeds** **Osiers**
Rough Pasture **Furze** **Wood**
Mixed Wood **Brushwood** **Orchard**
Fir **Ford** **Stepping Stones**
Ferry **Waterfall** **Lock**
Trig. Station **Altitude at Trig. Station**
B.M. 325.9 **Bench Mark** **Surface Level**
Arrow denotes flow of water **Antiquities (site of)**
Cutting **Embankment**
Railway crossing Road **Level Crossing** **Road crossing Railway**
Railway crossing River or Canal **Road over single stream** **Road over River or Canal**
County Boundary (Geographical)
County & Civil Parish Boundary
Administrative County & Civil Parish Boundary
County Borough Boundary (England)
Co. Boro. Bdy.
County Burgh Boundary (Scotland)
Co. Burgh Bdy.
BP BS Boundary Post or Stone **P.C.B** Police Call Box
B.R. Bridle Road **P** Pump
E.P Electricity Pylon **S.P** Signal Post
F.B. Foot Bridge **SL** Sluice
F.P. Foot Path **Sp.** Spring
G.P Guide Post or Board **T.C.B** Telephone Call Box
M.S Mile Stone **Tr.** Trough
M.P M.R Mooring Post or Ring **W** Well

Ordnance Survey Plan, Additional SIMs and Supply of Unpublished Survey Information 1:2,500 and 1:1,250

Inactive Quarry, Chalk Pit or Clay Pit **Active Quarry, Chalk Pit or Clay Pit**
Rock **Boulders**
Cliff **Slopes** **Top**
Roofed Building **Glazed Roof Building**
Sloping Masonry **Archway**
Non-Coniferous Tree (surveyed) **Coniferous Tree (surveyed)**
Non-Coniferous Trees (not surveyed) **Coniferous Trees (not surveyed)**
Orchard Tree **Scrub** **Bracken**
Coppice, Osier **Reeds** **Marsh, Saltings**
Rough Grassland **Heath** **Culvert**
Direction of water flow **Bench Mark** **Antiquity (site of)**
Cave Entrance **Triangulation Station** **Electricity Pylon**
Electricity Transmission Line
County Boundary (Geographical)
County & Civil Parish Boundary
Civil Parish Boundary
Admin. County or County Bor. Boundary
London Borough Boundary
Symbol marking point where boundary mereing changes
BH Beer House **P** Pillar, Pole or Post
BP, BS Boundary Post or Stone **PO** Post Office
Cn, C Capstan, Crane **PC** Public Convenience
Chy Chimney **PH** Public House
D Fn Drinking Fountain **Pp** Pump
EI P Electricity Pillar or Post **SB, S Br** Signal Box or Bridge
FAP Fire Alarm Pillar **SP, SL** Signal Post or Light
FB Foot Bridge **Spr** Spring
GP Guide Post **Tk** Tank or Track
H Hydrant or Hydraulic **TCB** Telephone Call Box
LC Level Crossing **TCP** Telephone Call Post
MH Manhole **Tr** Trough
MP Mile Post or Mooring Post **Wr Pt, Wr T** Water Point, Water Tap
MS Mile Stone **W** Well
NTL Normal Tidal Limit **Wd Pp** Wind Pump

Large-Scale National Grid Data 1:2,500 and 1:1,250

Cliff **Slopes** **Top**
Rock **Rock (scattered)**
Boulders **Boulders (scattered)**
Positioned Boulder **Scree**
Non-Coniferous Tree (surveyed) **Coniferous Tree (surveyed)**
Non-Coniferous Trees (not surveyed) **Coniferous Trees (not surveyed)**
Orchard Tree **Scrub** **Bracken**
Coppice, Osier **Reeds** **Marsh, Saltings**
Rough Grassland **Heath** **Culvert**
Direction of water flow **Triangulation Station** **Antiquity (site of)**
Electricity Transmission Line **Electricity Pylon**
B.M. 231.60m Bench Mark **Buildings with Building Seed**
Roofed Building **Glazed Roof Building**
Civil parish/community boundary
District boundary
County boundary
Boundary post/stone
Boundary mereing symbol (note: these always appear in opposed pairs or groups of three)
Bks Barracks **P** Pillar, Pole or Post
Bty Battery **PO** Post Office
Cemy Cemetery **PC** Public Convenience
Chy Chimney **Pp** Pump
Cis Cistern **Ppg Sta** Pumping Station
Dismtd Rly Dismantled Railway **PW** Place of Worship
EI Gen Sta Electricity Generating Station **Sewage Ppg Sta** Sewage Pumping Station
EI P Electricity Pole, Pillar **SB, S Br** Signal Box or Bridge
EI Sub Sta Electricity Sub Station **SP, SL** Signal Post or Light
FB Filter Bed **Spr** Spring
Fn / D Fn Fountain / Drinking Ftn. **Tk** Tank or Track
Gas Gov Gas Valve Compound **Tr** Trough
GVC Gas Governor **Wd Pp** Wind Pump
GP Guide Post **Wr Pt, Wr T** Water Point, Water Tap
MH Manhole **Wks** Works (building or area)
MP, MS Mile Post or Mile Stone **W** Well



Historical Mapping & Photography included:

Mapping Type	Scale	Date	Pg
Lincolnshire	1:2,500	1886	2
Lincolnshire	1:2,500	1906	3
Ordnance Survey Plan	1:2,500	1972 - 1974	4
Large-Scale National Grid Data	1:2,500	1994	5

Historical Map - Segment C15

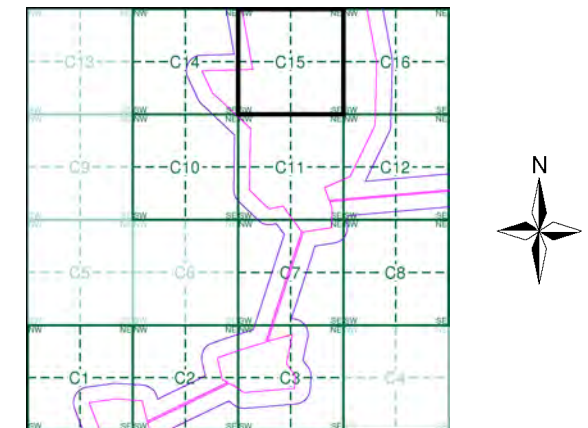

Order Details

Order Number: 297990273_1_1
 Customer Ref: 21-1088.04
 National Grid Reference: 490170, 385250
 Slice: C
 Site Area (Ha): 469.98
 Search Buffer (m): 100

Site Details

Cottam



Tel: [Redacted]
 Fax: [Redacted]
 Web: [Redacted]

Lincolnshire

Published 1886

Source map scale - 1:2,500

The historical maps shown were reproduced from maps predominantly held at the scale adopted for England, Wales and Scotland in the 1840's. In 1854 the 1:2,500 scale was adopted for mapping urban areas and by 1896 it covered the whole of what were considered to be the cultivated parts of Great Britain. The published date given below is often some years later than the surveyed date. Before 1938, all OS maps were based on the Cassini Projection, with independent surveys of a single county or group of counties, giving rise to significant inaccuracies in outlying areas.

Map Name(s) and Date(s)

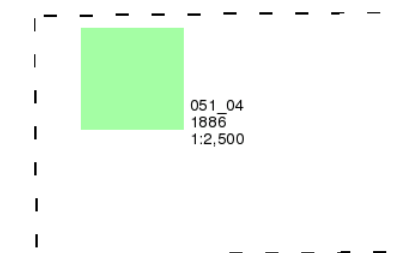

Historical Map - Segment C15

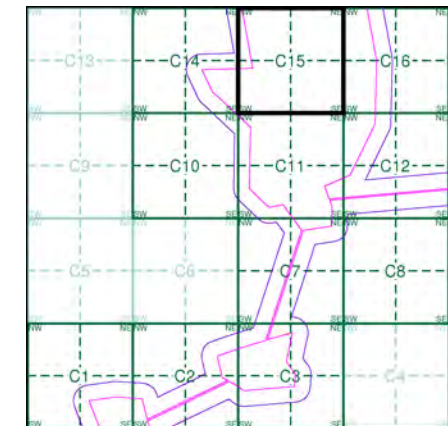

Order Details

Order Number: 297990273_1_1
 Customer Ref: 21-1088.04
 National Grid Reference: 490170, 385250
 Slice: C
 Site Area (Ha): 469.98
 Search Buffer (m): 100

Site Details

Cottam

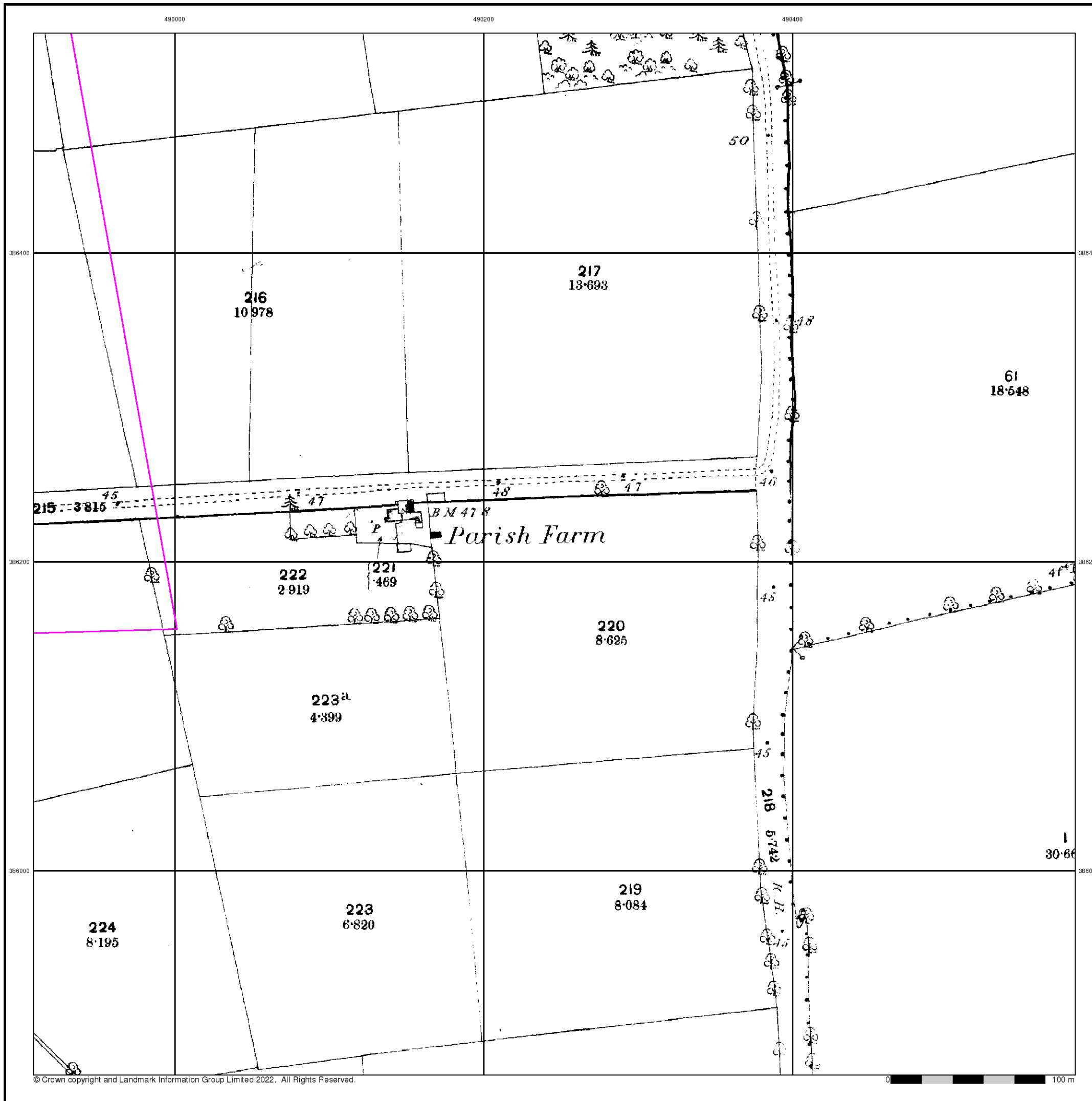

Lincolnshire

Published 1906

Source map scale - 1:2,500

The historical maps shown were reproduced from maps predominantly held at the scale adopted for England, Wales and Scotland in the 1840's. In 1854 the 1:2,500 scale was adopted for mapping urban areas and by 1896 it covered the whole of what were considered to be the cultivated parts of Great Britain. The published date given below is often some years later than the surveyed date. Before 1938, all OS maps were based on the Cassini Projection, with independent surveys of a single county or group of counties, giving rise to significant inaccuracies in outlying areas.

Map Name(s) and Date(s)

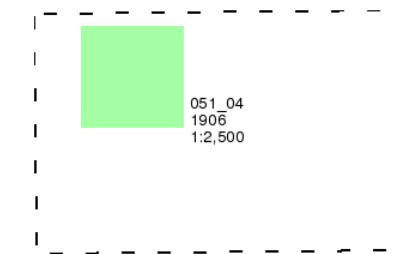

Historical Map - Segment C15

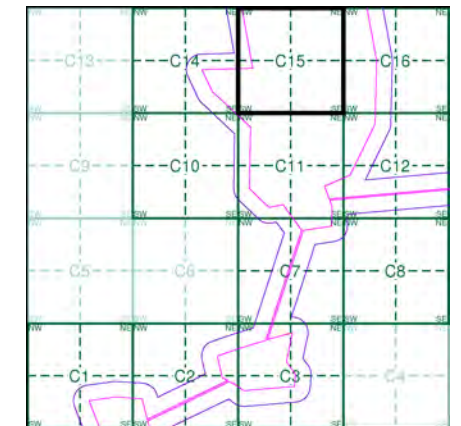

Order Details

Order Number: 297990273_1_1
 Customer Ref: 21-1088.04
 National Grid Reference: 490170, 385250
 Slice: C
 Site Area (Ha): 469.98
 Search Buffer (m): 100

Site Details

Cottam

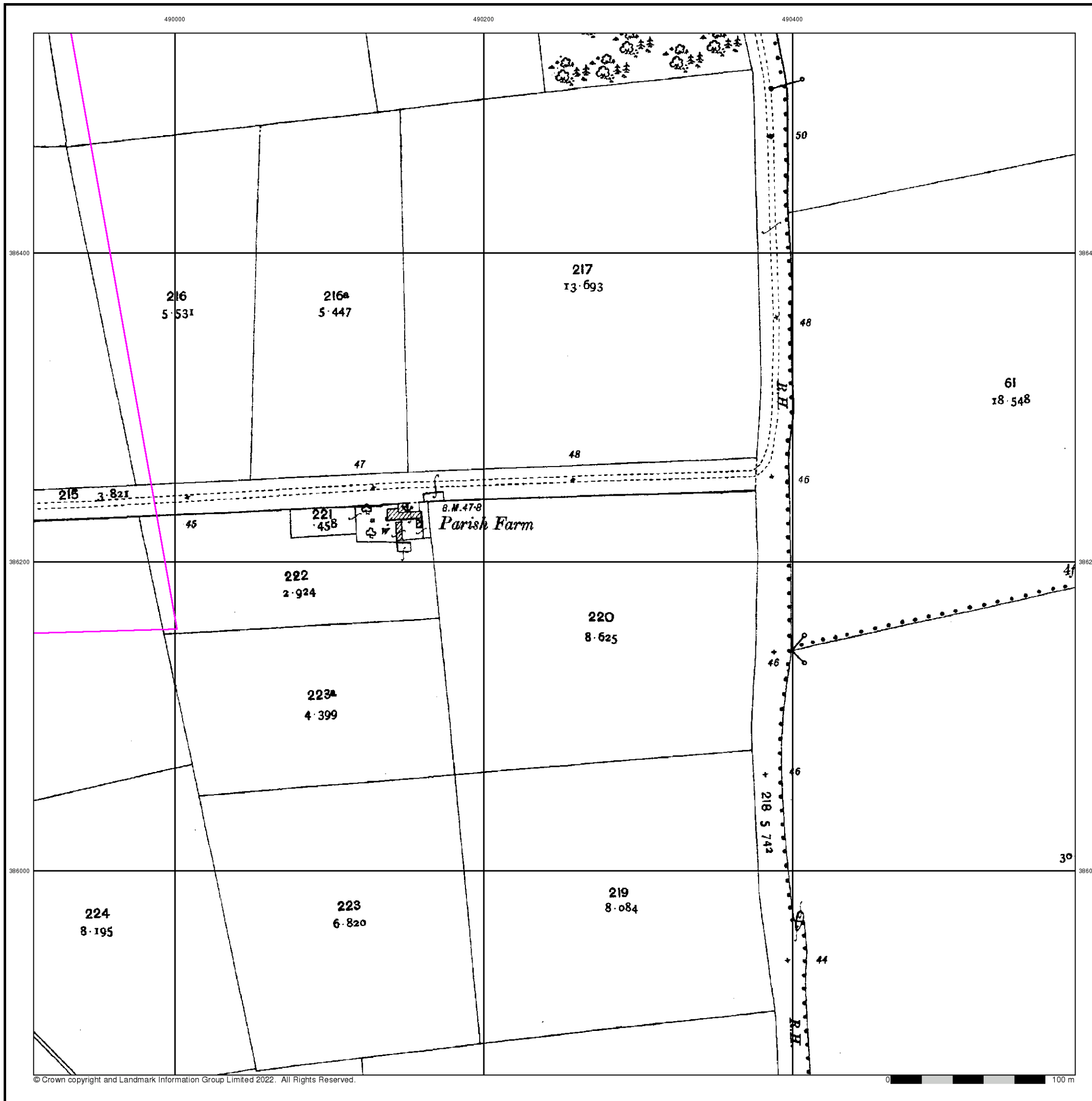

Ordnance Survey Plan

Published 1972 - 1974

Source map scale - 1:2,500

The historical maps shown were reproduced from maps predominantly held at the scale adopted for England, Wales and Scotland in the 1840's. In 1854 the 1:2,500 scale was adopted for mapping urban areas and by 1896 it covered the whole of what were considered to be the cultivated parts of Great Britain. The published date given below is often some years later than the surveyed date. Before 1938, all OS maps were based on the Cassini Projection, with independent surveys of a single county or group of counties, giving rise to significant inaccuracies in outlying areas.

Map Name(s) and Date(s)

SK8986 1972 1:2,500	SK9086 1974 1:2,500
SK8985 1972 1:2,500	SK9085 1974 1:2,500

Historical Map - Segment C15

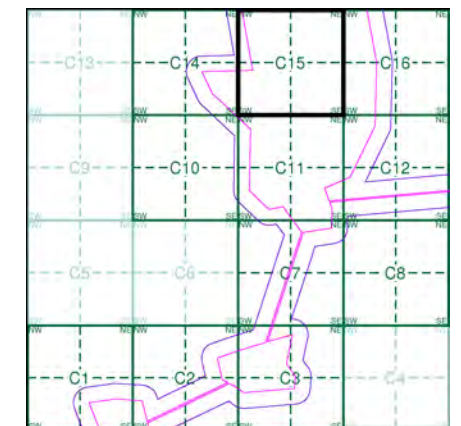

Order Details

Order Number: 297990273_1_1
 Customer Ref: 21-1088.04
 National Grid Reference: 490170, 385250
 Slice: C
 Site Area (Ha): 469.98
 Search Buffer (m): 100

Site Details

Cottam

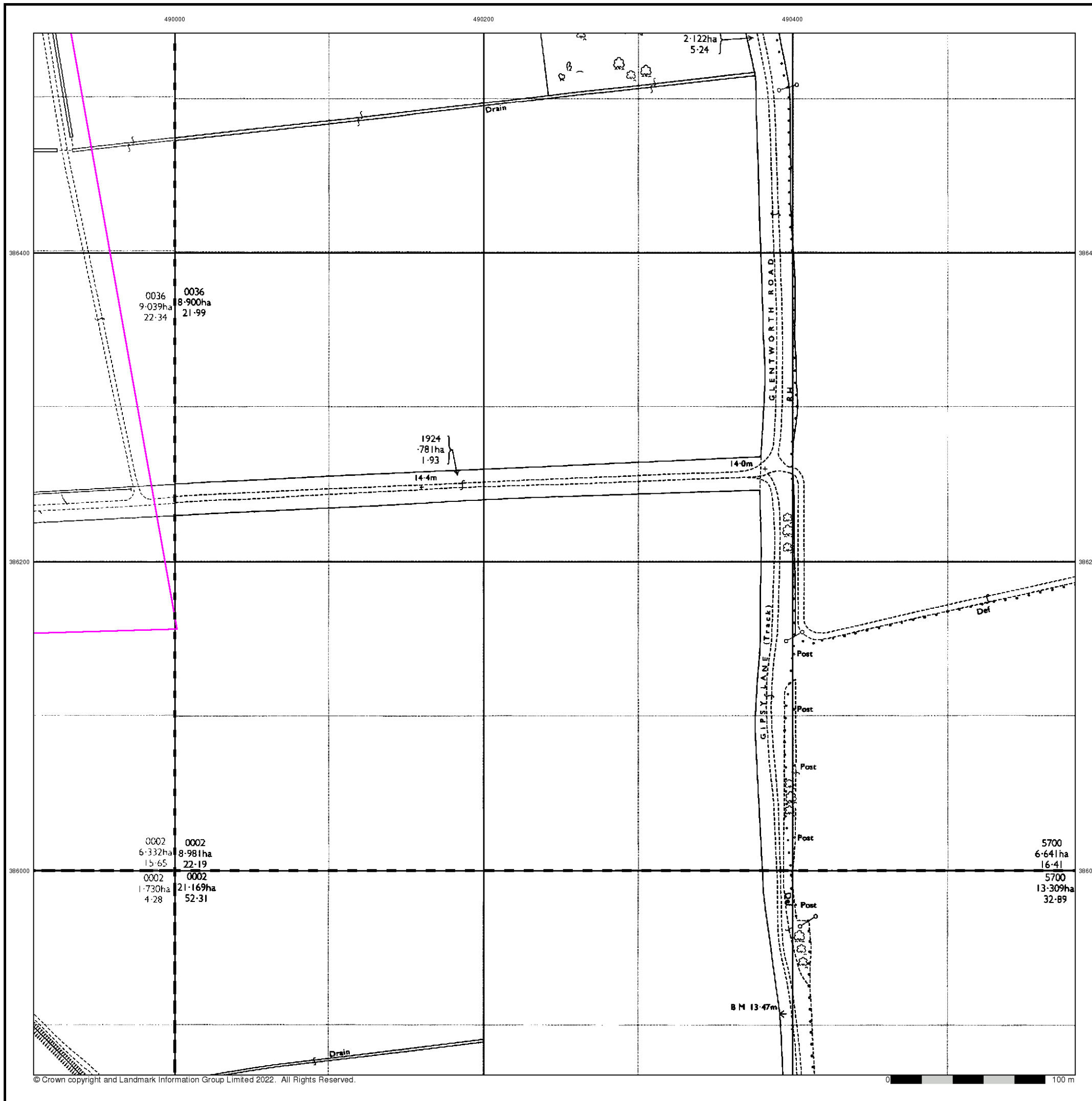

Large-Scale National Grid Data

Published 1994

Source map scale - 1:2,500

'Large Scale National Grid Data' superseded SIM cards (Ordnance Survey's 'Survey of Information on Microfilm') in 1992, and continued to be produced until 1999. These maps were the fore-runners of digital mapping and so provide detailed information on houses and roads, but tend to show less topographic features such as vegetation. These maps were produced at both 1:2,500 and 1:1,250 scales.

Map Name(s) and Date(s)

SK8986 1994 1:2,500	SK9086 1994 1:2,500
SK8985 1994 1:2,500	SK9085 1994 1:2,500

Historical Map - Segment C15

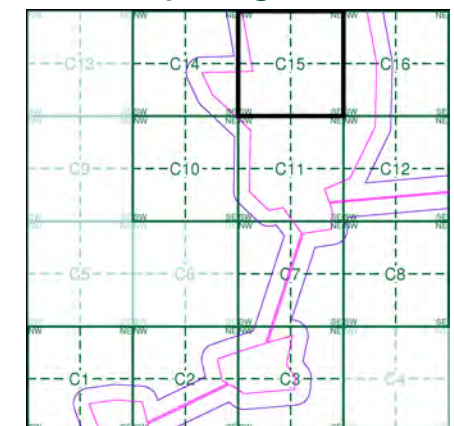

Order Details

Order Number: 297990273_1_1
 Customer Ref: 21-1088.04
 National Grid Reference: 490170, 385250
 Slice: C
 Site Area (Ha): 469.98
 Search Buffer (m): 100

Site Details

Cottam

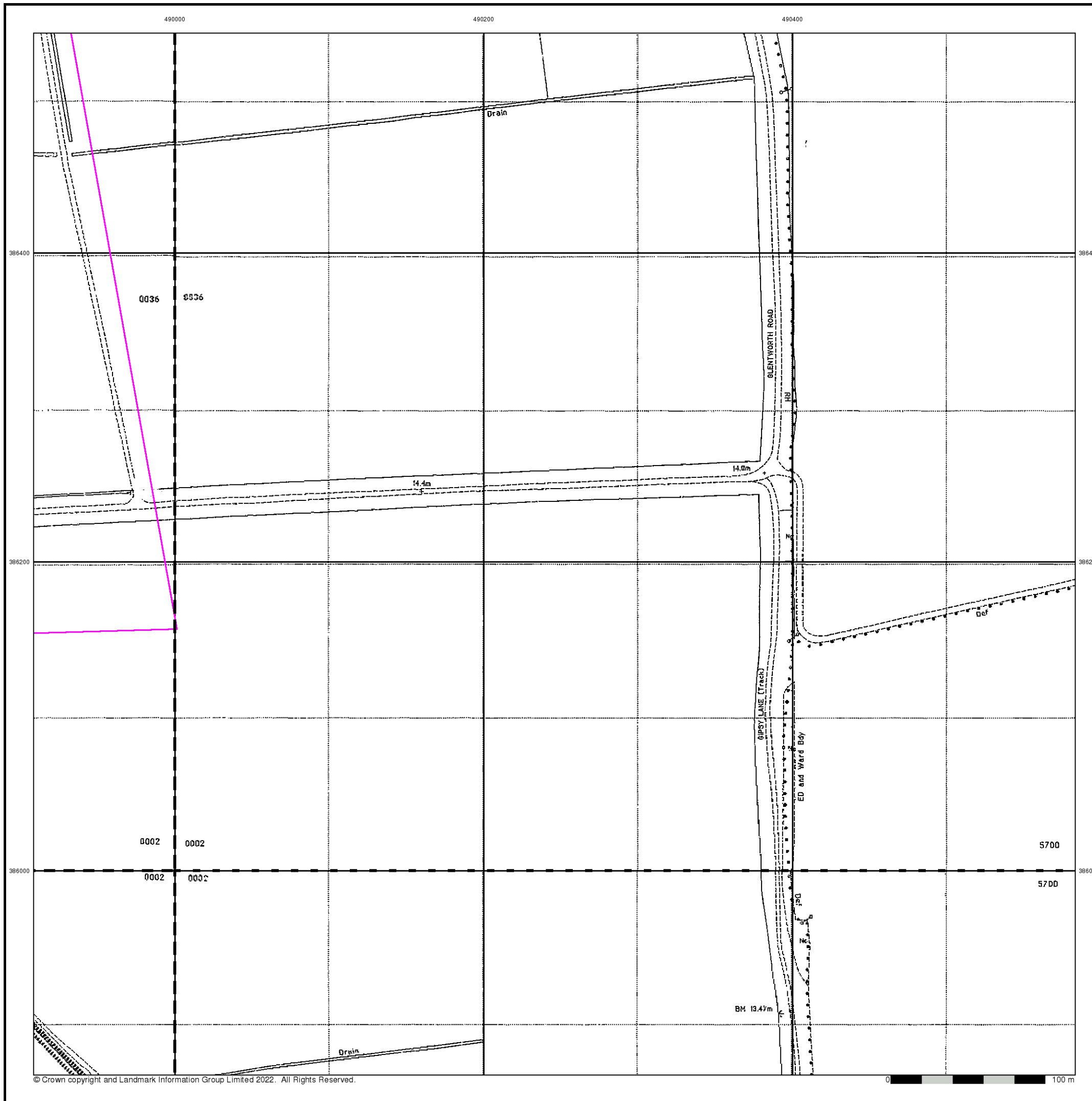

Historical Mapping Legends

Ordnance Survey County Series and Ordnance Survey Plan 1:2,500

Quarry **Gravel Pit** **Sand Pit**
Clay Pit **Shingle** **Refuse Heap**
Sloping Masonry **Flat Rock**
Marsh **Reeds** **Osiers**
Rough Pasture **Furze** **Wood**
Mixed Wood **Brushwood** **Orchard**
Fir **Ford** **Stepping Stones**
Ferry **Waterfall** **Lock**
Trig. Station **Altitude at Trig. Station**
B.M. 325.9 **Bench Mark** **Surface Level**
Arrow denotes flow of water **Antiquities (site of)**
Cutting **Embankment**
Railway crossing Road **Level Crossing** **Road crossing Railway**
Railway crossing River or Canal **Road over single stream** **Road over River or Canal**
County Boundary (Geographical)
County & Civil Parish Boundary
Administrative County & Civil Parish Boundary
County Borough Boundary (England)
Co. Boro. Bdy.
County Burgh Boundary (Scotland)
Co. Burgh Bdy.
BP BS Boundary Post or Stone **P.C.B** Police Call Box
B.R. Bridle Road **P** Pump
E.P Electricity Pylon **S.P** Signal Post
F.B. Foot Bridge **SL** Sluice
F.P. Foot Path **Sp.** Spring
G.P Guide Post or Board **T.C.B** Telephone Call Box
M.S Mile Stone **Tr.** Trough
M.P M.R Mooring Post or Ring **W** Well

Ordnance Survey Plan, Additional SIMs and Supply of Unpublished Survey Information 1:2,500 and 1:1,250

Inactive Quarry, Chalk Pit or Clay Pit **Active Quarry, Chalk Pit or Clay Pit**
Rock **Boulders**
Cliff **Slopes** **Top**
Roofed Building **Glazed Roof Building**
Sloping Masonry **Archway**
Non-Coniferous Tree (surveyed) **Coniferous Tree (surveyed)**
Non-Coniferous Trees (not surveyed) **Coniferous Trees (not surveyed)**
Orchard Tree **Scrub** **Bracken**
Coppice, Osier **Reeds** **Marsh, Saltings**
Rough Grassland **Heath** **Culvert**
Direction of water flow **Bench Mark** **Antiquity (site of)**
Cave Entrance **Triangulation Station** **Electricity Pylon**
Electricity Transmission Line
County Boundary (Geographical)
County & Civil Parish Boundary
Civil Parish Boundary
Admin. County or County Bor. Boundary
London Borough Boundary
Symbol marking point where boundary mereing changes
BH Beer House **P** Pillar, Pole or Post
BP, BS Boundary Post or Stone **PO** Post Office
Cn, C Capstan, Crane **PC** Public Convenience
Chy Chimney **PH** Public House
D Fn Drinking Fountain **Pp** Pump
EI P Electricity Pillar or Post **SB, S Br** Signal Box or Bridge
FAP Fire Alarm Pillar **SP, SL** Signal Post or Light
FB Foot Bridge **Spr** Spring
GP Guide Post **Tk** Tank or Track
H Hydrant or Hydraulic **TCB** Telephone Call Box
LC Level Crossing **TCP** Telephone Call Post
MH Manhole **Tr** Trough
MP Mile Post or Mooring Post **Wr Pt, Wr T** Water Point, Water Tap
MS Mile Stone **W** Well
NTL Normal Tidal Limit **Wd Pp** Wind Pump

Large-Scale National Grid Data 1:2,500 and 1:1,250

Cliff **Slopes** **Top**
Rock **Rock (scattered)**
Boulders **Boulders (scattered)**
Positioned Boulder **Scree**
Non-Coniferous Tree (surveyed) **Coniferous Tree (surveyed)**
Non-Coniferous Trees (not surveyed) **Coniferous Trees (not surveyed)**
Orchard Tree **Scrub** **Bracken**
Coppice, Osier **Reeds** **Marsh, Saltings**
Rough Grassland **Heath** **Culvert**
Direction of water flow **Triangulation Station** **Antiquity (site of)**
Electricity Transmission Line **Electricity Pylon**
B.M. 231.60m Bench Mark **Buildings with Building Seed**
Roofed Building **Glazed Roof Building**
Civil parish/community boundary
District boundary
County boundary
Boundary post/stone
Boundary mereing symbol (note: these always appear in opposed pairs or groups of three)
Bks Barracks **P** Pillar, Pole or Post
Bty Battery **PO** Post Office
Cemy Cemetery **PC** Public Convenience
Chy Chimney **Pp** Pump
Cis Cistern **Ppg Sta** Pumping Station
Dismtd Rly Dismantled Railway **PW** Place of Worship
EI Gen Sta Electricity Generating Station **Sewage Ppg Sta** Sewage Pumping Station
EI P Electricity Pole, Pillar **SB, S Br** Signal Box or Bridge
EI Sub Sta Electricity Sub Station **SP, SL** Signal Post or Light
FB Filter Bed **Spr** Spring
Fn / D Fn Fountain / Drinking Ftn. **Tk** Tank or Track
Gas Gov Gas Valve Compound **Tr** Trough
GVC Gas Governor **Wd Pp** Wind Pump
GP Guide Post **Wr Pt, Wr T** Water Point, Water Tap
MH Manhole **Wks** Works (building or area)
MP, MS Mile Post or Mile Stone **W** Well



Historical Mapping & Photography included:

Mapping Type	Scale	Date	Pg
Lincolnshire	1:2,500	1886	2
Lincolnshire	1:2,500	1906	3
Ordnance Survey Plan	1:2,500	1974	4
Large-Scale National Grid Data	1:2,500	1994	5

Historical Map - Segment C16

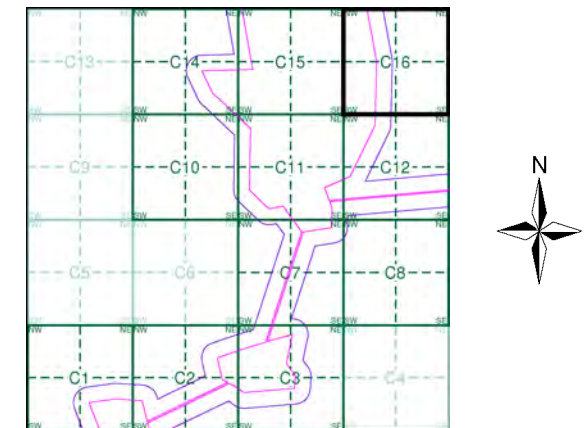

Order Details

Order Number: 297990273_1_1
 Customer Ref: 21-1088.04
 National Grid Reference: 490170, 385250
 Slice: C
 Site Area (Ha): 469.98
 Search Buffer (m): 100

Site Details

Cottam



Tel: [Redacted]
 Fax: [Redacted]
 Web: [Redacted]

Lincolnshire

Published 1886

Source map scale - 1:2,500

The historical maps shown were reproduced from maps predominantly held at the scale adopted for England, Wales and Scotland in the 1840's. In 1854 the 1:2,500 scale was adopted for mapping urban areas and by 1896 it covered the whole of what were considered to be the cultivated parts of Great Britain. The published date given below is often some years later than the surveyed date. Before 1938, all OS maps were based on the Cassini Projection, with independent surveys of a single county or group of counties, giving rise to significant inaccuracies in outlying areas.

Map Name(s) and Date(s)

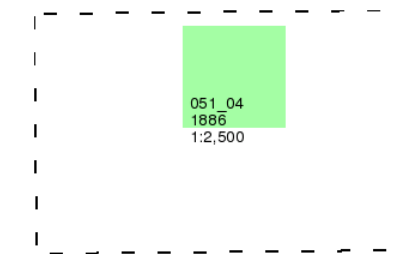

Historical Map - Segment C16

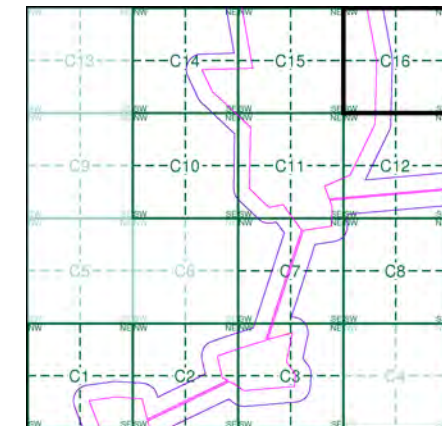

Order Details

Order Number: 297990273_1_1
 Customer Ref: 21-1088.04
 National Grid Reference: 490170, 385250
 Slice: C
 Site Area (Ha): 469.98
 Search Buffer (m): 100

Site Details

Cottam

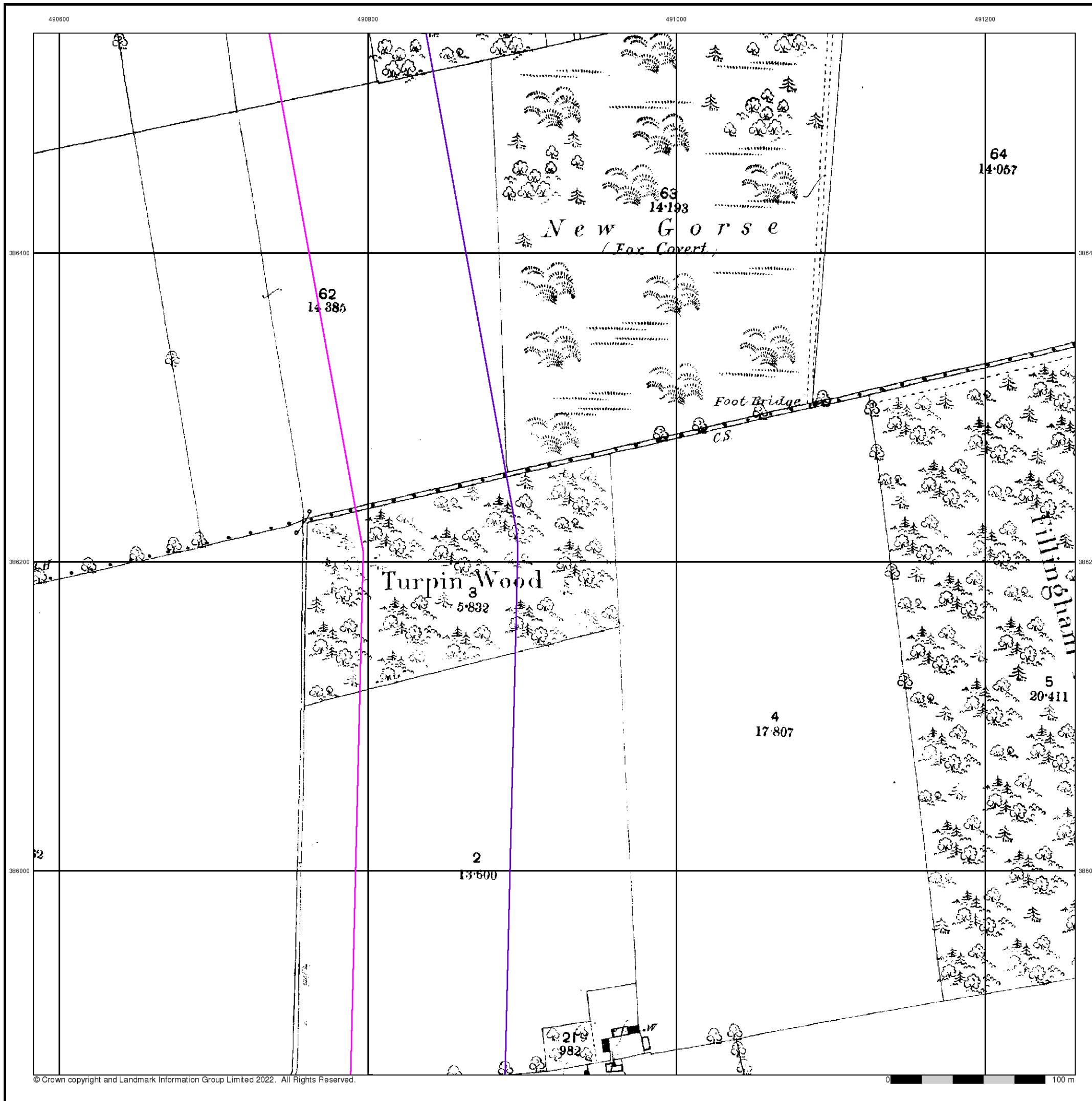

Lincolnshire

Published 1906

Source map scale - 1:2,500

The historical maps shown were reproduced from maps predominantly held at the scale adopted for England, Wales and Scotland in the 1840's. In 1854 the 1:2,500 scale was adopted for mapping urban areas and by 1896 it covered the whole of what were considered to be the cultivated parts of Great Britain. The published date given below is often some years later than the surveyed date. Before 1938, all OS maps were based on the Cassini Projection, with independent surveys of a single county or group of counties, giving rise to significant inaccuracies in outlying areas.

Map Name(s) and Date(s)

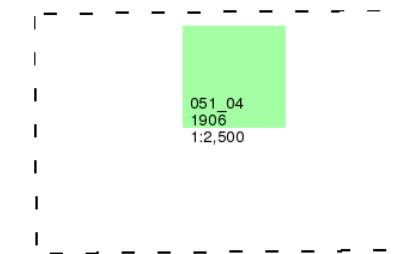

Historical Map - Segment C16

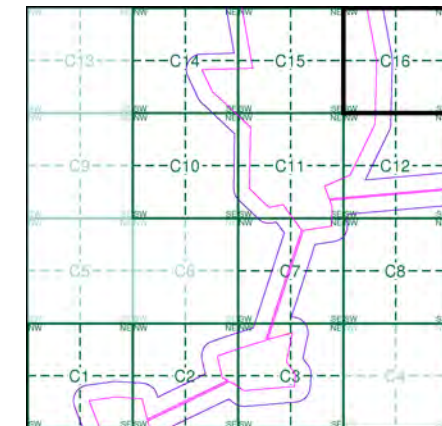

Order Details

Order Number: 297990273_1_1
 Customer Ref: 21-1088.04
 National Grid Reference: 490170, 385250
 Slice: C
 Site Area (Ha): 469.98
 Search Buffer (m): 100

Site Details

Cottam

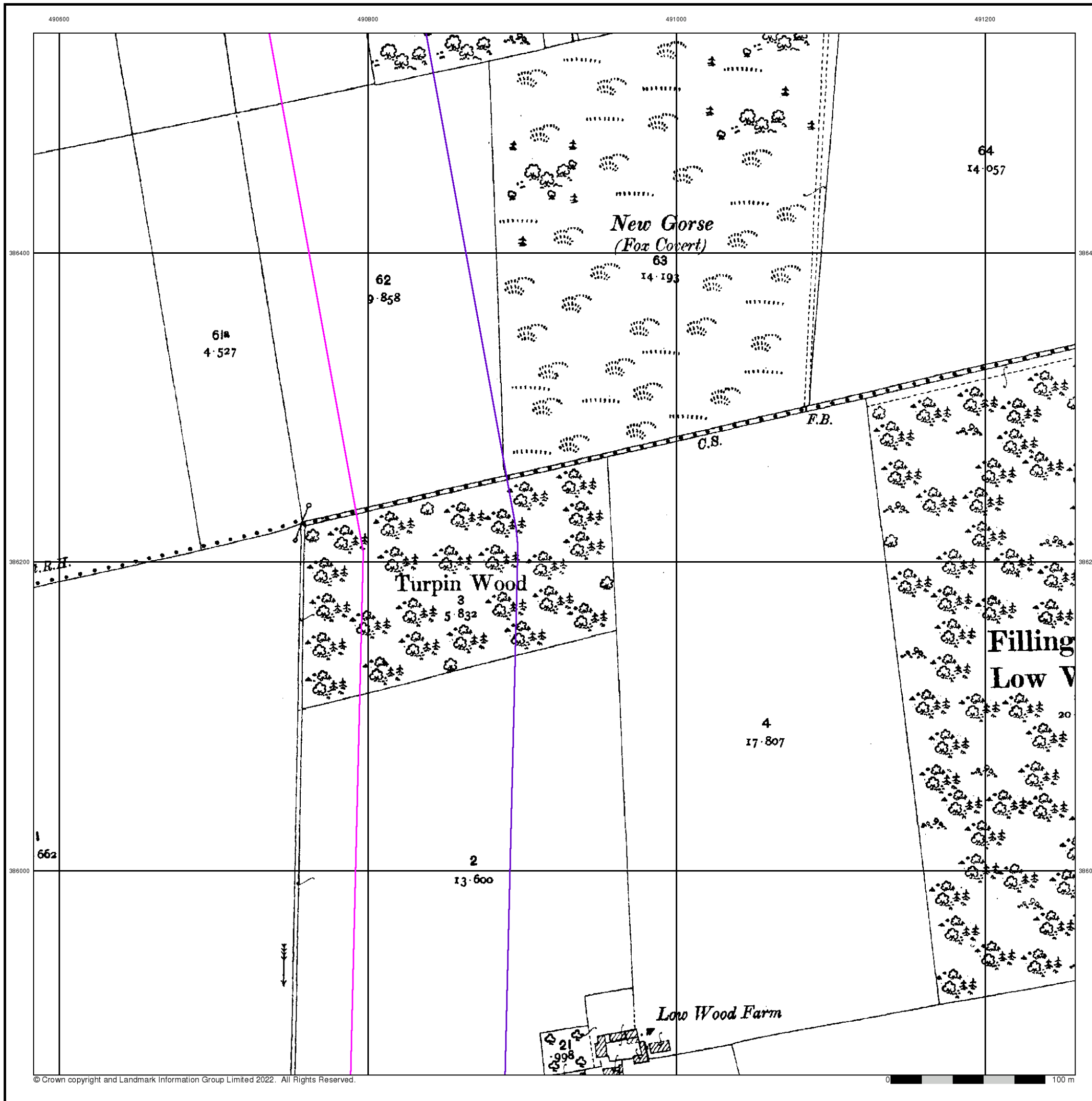

Ordnance Survey Plan

Published 1974

Source map scale - 1:2,500

The historical maps shown were reproduced from maps predominantly held at the scale adopted for England, Wales and Scotland in the 1840's. In 1854 the 1:2,500 scale was adopted for mapping urban areas and by 1896 it covered the whole of what were considered to be the cultivated parts of Great Britain. The published date given below is often some years later than the surveyed date. Before 1938, all OS maps were based on the Cassini Projection, with independent surveys of a single county or group of counties, giving rise to significant inaccuracies in outlying areas.

Map Name(s) and Date(s)

SK9086 1974 1:2,500	SK9186 1974 1:2,500
SK9085 1974 1:2,500	SK9185 1974 1:2,500

Historical Map - Segment C16

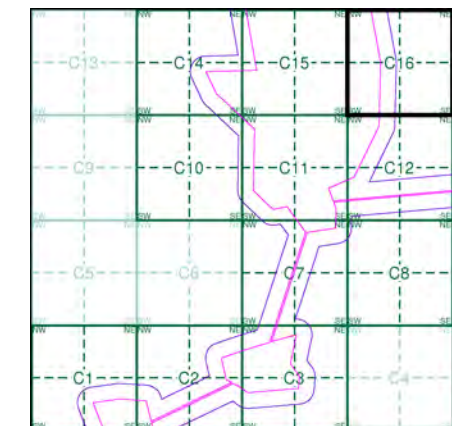

Order Details

Order Number: 297990273_1_1
 Customer Ref: 21-1088.04
 National Grid Reference: 490170, 385250
 Slice: C
 Site Area (Ha): 469.98
 Search Buffer (m): 100

Site Details

Cottam

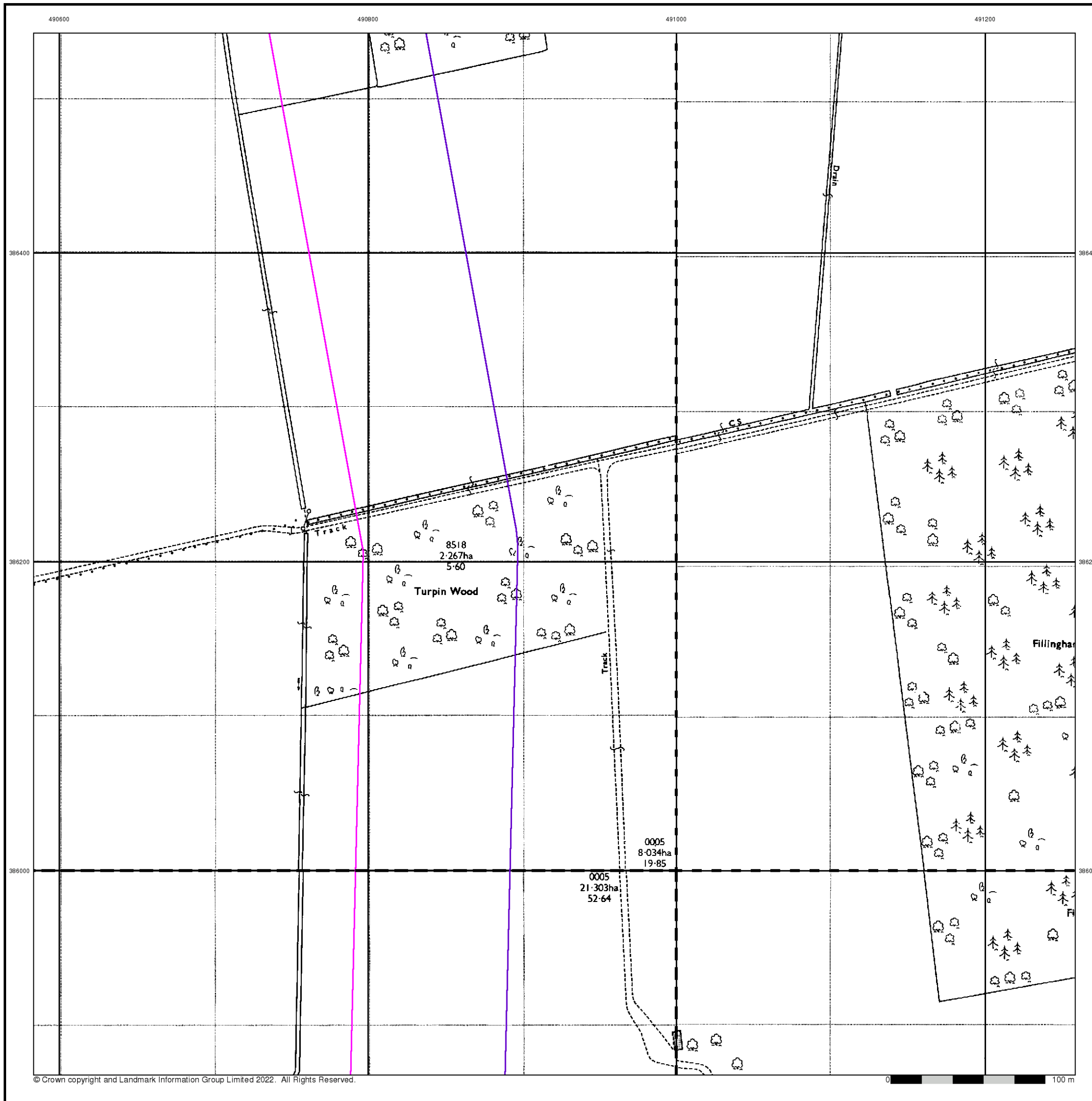

Large-Scale National Grid Data

Published 1994

Source map scale - 1:2,500

'Large Scale National Grid Data' superseded SIM cards (Ordnance Survey's 'Survey of Information on Microfilm') in 1992, and continued to be produced until 1999. These maps were the fore-runners of digital mapping and so provide detailed information on houses and roads, but tend to show less topographic features such as vegetation. These maps were produced at both 1:2,500 and 1:1,250 scales.

Map Name(s) and Date(s)

SK9086	SK9186
1994	1994
12,500	12,500
SK9085	SK9185
1994	1994
12,500	12,500

Historical Map - Segment C16

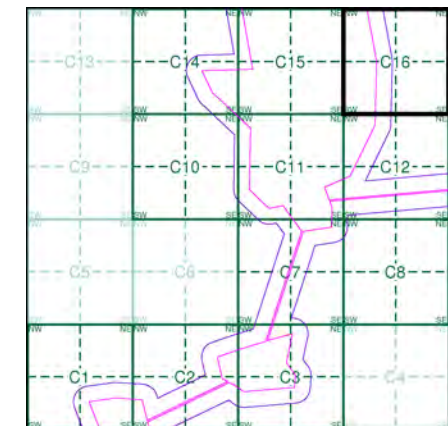

Order Details

Order Number: 297990273_1_1
 Customer Ref: 21-1088.04
 National Grid Reference: 490170, 385250
 Slice: C
 Site Area (Ha): 469.98
 Search Buffer (m): 100

Site Details

Cottam

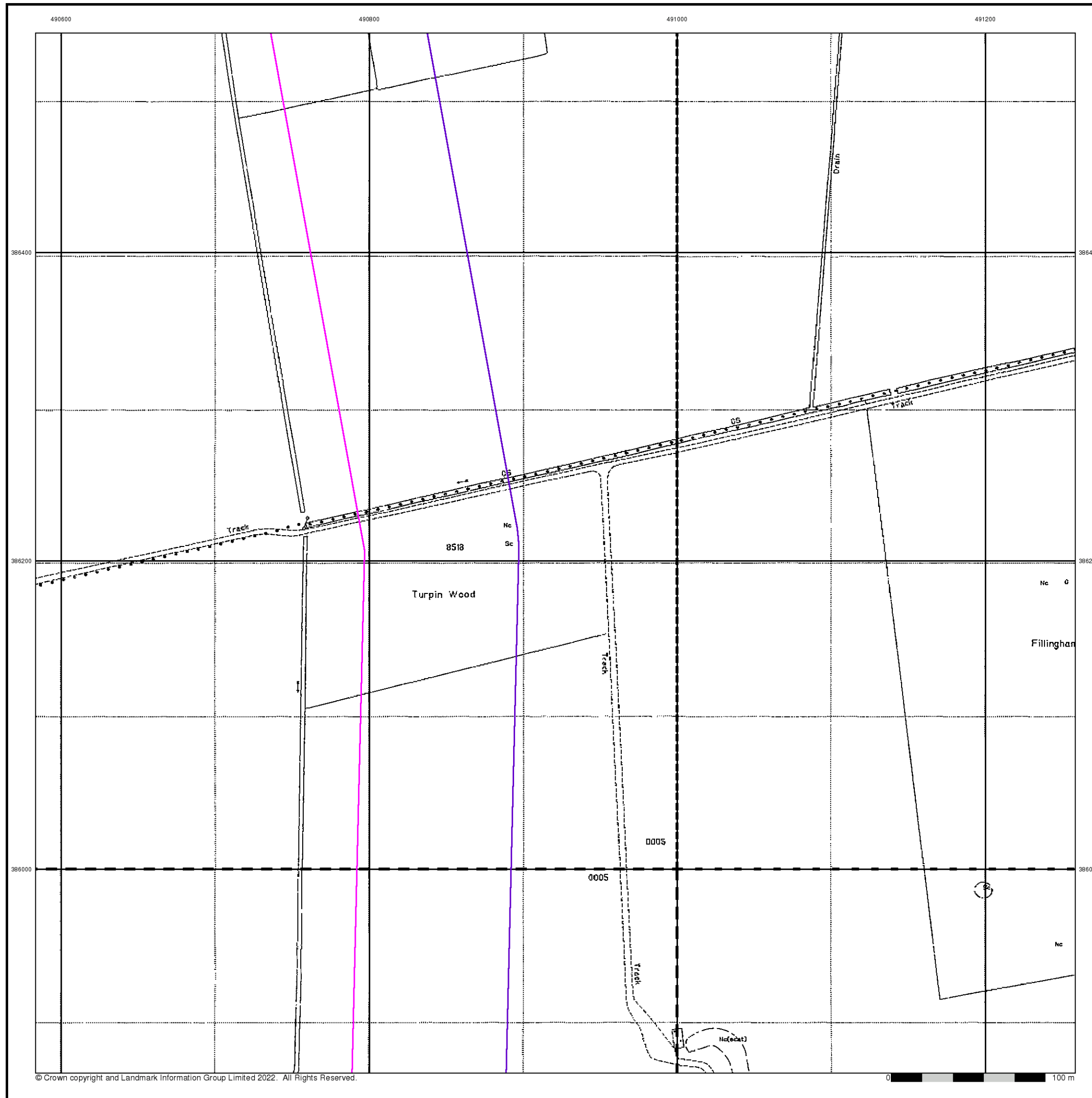

Historical Mapping Legends

Ordnance Survey County Series 1:10,560

	Gravel Pit		Sand Pit		Other Pits
	Quarry		Shingle		Orchard
	Osiers		Reeds		Marsh
	Mixed Wood		Deciduous		Brushwood
	Fir		Furze		Rough Pasture
	Arrow denotes flow of water		Trigonometrical Station		
	Site of Antiquities		Bench Mark		
	Pump, Guide Post, Signal Post		Well, Spring, Boundary Post		
	-285 Surface Level				
	Sketched Contour		Instrumental Contour		
	Main Roads		Minor Roads		
	Sunken Road		Raised Road		
	Road over Railway		Railway over River		
	Railway over Road		Level Crossing		
	Road over River or Canal		Road over Stream		
	Road over Stream				
	County Boundary (Geographical)				
	County & Civil Parish Boundary				
	Administrative County & Civil Parish Boundary				
	County Borough Boundary (England)				
	County Burgh Boundary (Scotland)				
	Rural District Boundary				
	Civil Parish Boundary				

Ordnance Survey Plan 1:10,000

	Chalk Pit, Clay Pit or Quarry		Gravel Pit
	Sand Pit		Disused Pit or Quarry
	Refuse or Slag Heap		Lake, Loch or Pond
	Dunes		Boulders
	Coniferous Trees		Non-Coniferous Trees
	Orchard		Scrub
	Coppice		Heath
	Rough Grassland		Marsh
	Reeds		Saltings
	Building		Glasshouse
	Sloping Masonry		Pylon
	Electricity Transmission Line		Pole
	Cutting		Embankment
	Standard Gauge Multiple Track		Standard Gauge Single Track
	Siding, Tramway or Mineral Line		Narrow Gauge
	Geographical County		
	Administrative County, County Borough or County of City		
	Municipal Borough, Urban or Rural District, Burgh or District Council		
	Borough, Burgh or County Constituency Shown only when not coincident with other boundaries		
	Civil Parish Shown alternately when coincidence of boundaries occurs		
	BP, BS Boundary Post or Stone		Pol Sta Police Station
	Ch Church		PO Post Office
	CH Club House		PC Public Convenience
	F E Sta Fire Engine Station		PH Public House
	FB Foot Bridge		SB Signal Box
	Fn Fountain		Spr Spring
	GP Guide Post		TCB Telephone Call Box
	MP Mile Post		TCP Telephone Call Post
	MS Mile Stone		W Well

1:10,000 Raster Mapping

	Gravel Pit		Refuse tip or slag heap
	Rock		Rock (scattered)
	Boulders		Boulders (scattered)
	Shingle		Mud
	Sand		Sand Pit
	Slopes		Top of cliff
	General detail		Underground detail
	Overhead detail		Narrow gauge railway
	Multi-track railway		Single track railway
	County boundary (England only)		Civil, parish or community boundary
	District, Unitary, Metropolitan, London Borough boundary		Constituency boundary
	Area of wooded vegetation		Non-coniferous trees
	Non-coniferous trees (scattered)		Coniferous trees
	Coniferous trees (scattered)		Positioned tree
	Orchard		Coppice or Osiers
	Rough Grassland		Heath
	Scrub		Marsh, Salt Marsh or Reeds
	Water feature		Flow arrows
	MHW(S) Mean high water (springs)		MLW(S) Mean low water (springs)
	Telephone line (where shown)		Electricity transmission line (with poles)
	Bench mark (where shown)		Triangulation station
	Point feature (e.g. Guide Post or Mile Stone)		Pylon, flare stack or lighting tower
	Site of (antiquity)		Glasshouse
	General Building		Important Building



Historical Mapping & Photography included:

Mapping Type	Scale	Date	Pg
Lincolnshire	1:10,560	1885 - 1886	2
Lincolnshire	1:10,560	1907	3
Lincolnshire	1:10,560	1907	4
Lincolnshire	1:10,560	1947	5
Ordnance Survey Plan	1:10,000	1956	6
Ordnance Survey Plan	1:10,000	1979	7
10K Raster Mapping	1:10,000	2000	8
Street View	Variable		9

Historical Map - Slice D

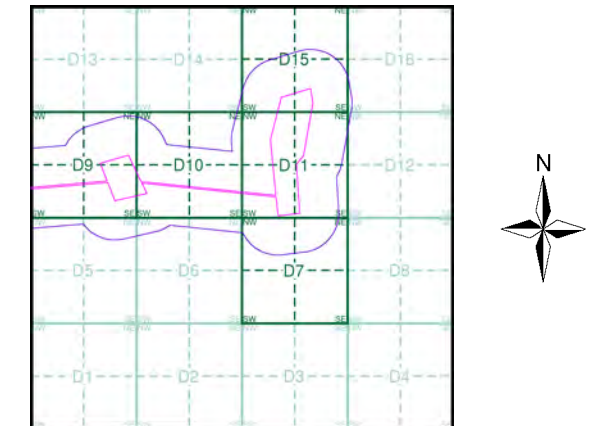

Order Details

Order Number: 297990273_1_1
 Customer Ref: 21-1088.04
 National Grid Reference: 492420, 385520
 Slice: D
 Site Area (Ha): 469.98
 Search Buffer (m): 250

Site Details

Cottam



Tel: [Redacted]
 Fax: [Redacted]
 Web: [Redacted]

Lincolnshire

Published 1885 - 1886

Source map scale - 1:10,560

The historical maps shown were reproduced from maps predominantly held at the scale adopted for England, Wales and Scotland in the 1840's. In 1854 the 1:2,500 scale was adopted for mapping urban areas; these maps were used to update the 1:10,560 maps. The published date given therefore is often some years later than the surveyed date. Before 1938, all OS maps were based on the Cassini Projection, with independent surveys of a single county or group of counties, giving rise to significant inaccuracies in outlying areas. In the late 1940's, a Provisional Edition was produced, which updated the 1:10,560 mapping from a number of sources. The maps appear unfinished - with all military camps and other strategic sites removed. These maps were initially overprinted with the National Grid. In 1970, the first 1:10,000 maps were produced using the Transverse Mercator Projection. The revision process continued until recently, with new editions appearing every 10 years or so for urban areas.

Map Name(s) and Date(s)

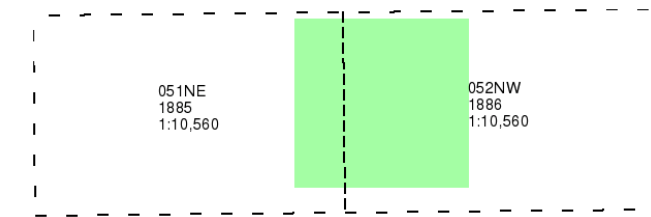

Historical Map - Slice D

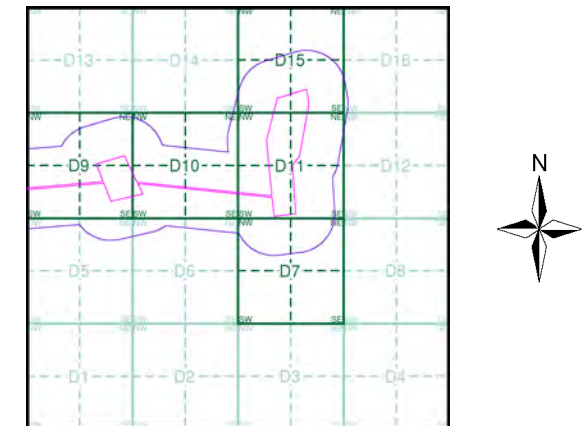

Order Details

Order Number: 297990273_1_1
 Customer Ref: 21-1088.04
 National Grid Reference: 492420, 385520
 Slice: D
 Site Area (Ha): 469.98
 Search Buffer (m): 250

Site Details

Cottam

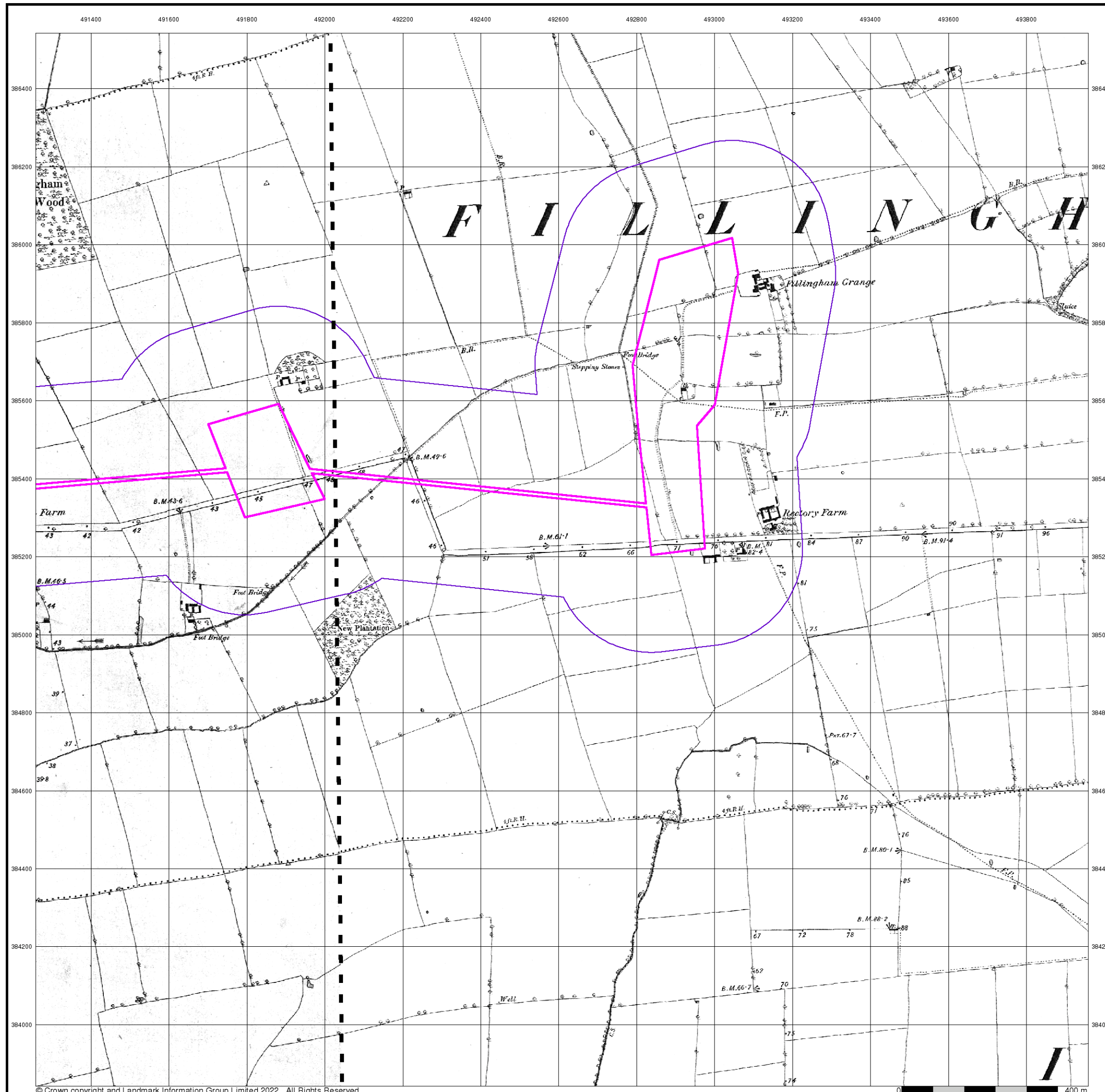

Lincolnshire

Published 1907

Source map scale - 1:10,560

The historical maps shown were reproduced from maps predominantly held at the scale adopted for England, Wales and Scotland in the 1840's. In 1854 the 1:2,500 scale was adopted for mapping urban areas; these maps were used to update the 1:10,560 maps. The published date given therefore is often some years later than the surveyed date. Before 1938, all OS maps were based on the Cassini Projection, with independent surveys of a single county or group of counties, giving rise to significant inaccuracies in outlying areas. In the late 1940's, a Provisional Edition was produced, which updated the 1:10,560 mapping from a number of sources. The maps appear unfinished - with all military camps and other strategic sites removed. These maps were initially overprinted with the National Grid. In 1970, the first 1:10,000 maps were produced using the Transverse Mercator Projection. The revision process continued until recently, with new editions appearing every 10 years or so for urban areas.

Map Name(s) and Date(s)

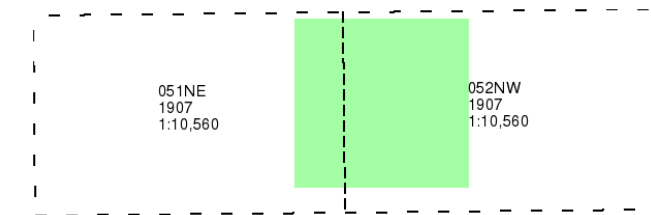

Historical Map - Slice D

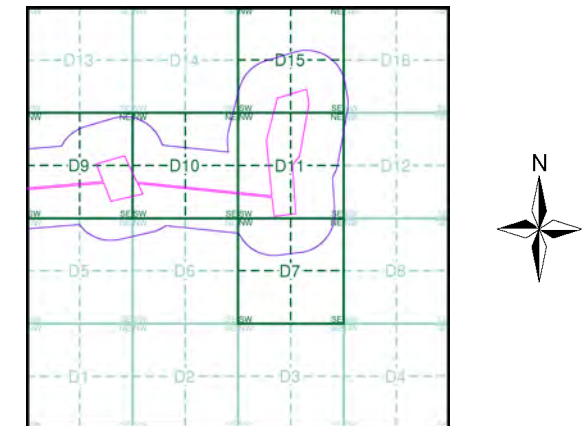

Order Details

Order Number: 297990273_1_1
 Customer Ref: 21-1088.04
 National Grid Reference: 492420, 385520
 Slice: D
 Site Area (Ha): 469.98
 Search Buffer (m): 250

Site Details

Cottam

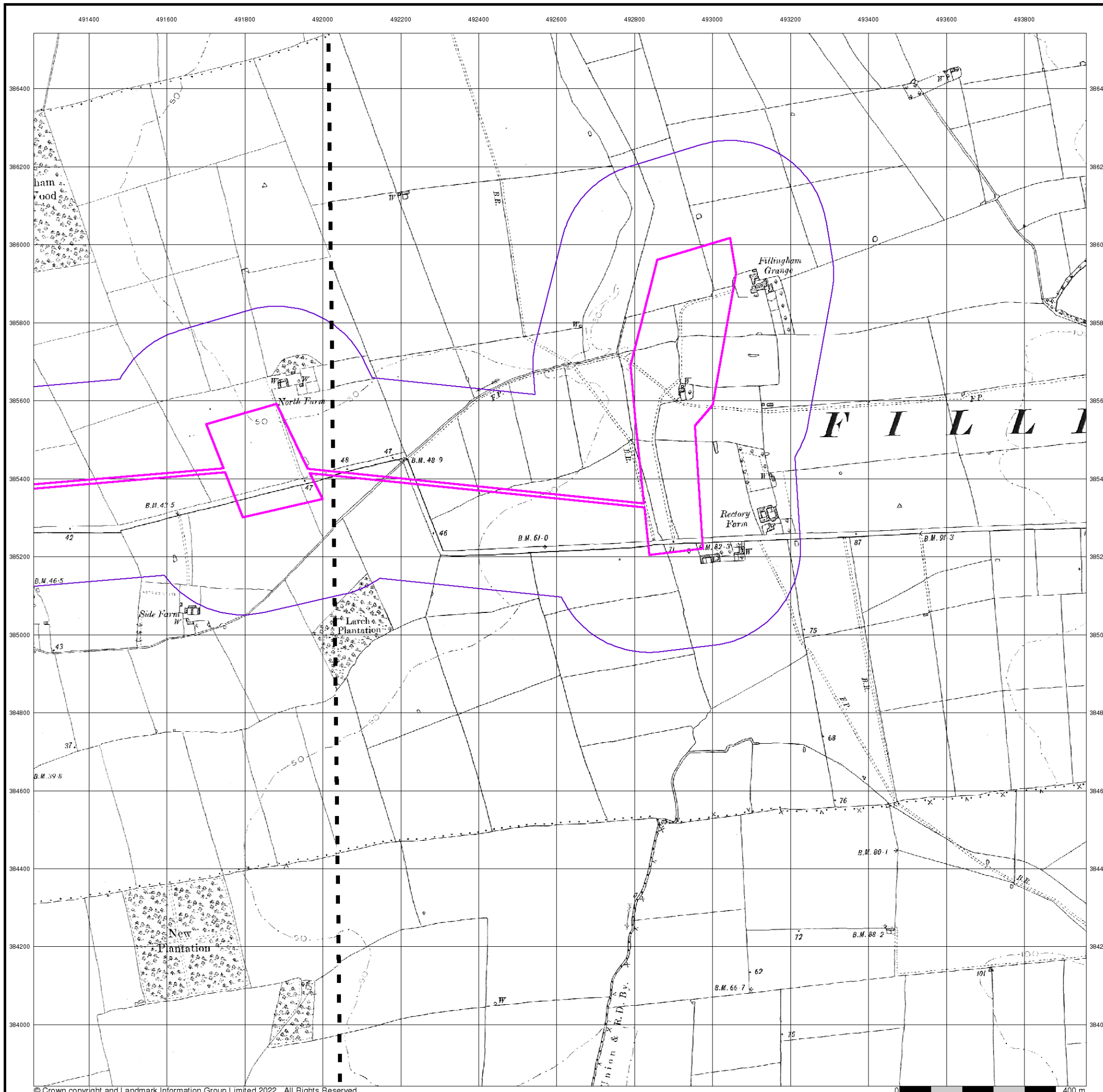

Lincolnshire

Published 1907

Source map scale - 1:10,560

The historical maps shown were reproduced from maps predominantly held at the scale adopted for England, Wales and Scotland in the 1840's. In 1854 the 1:2,500 scale was adopted for mapping urban areas; these maps were used to update the 1:10,560 maps. The published date given therefore is often some years later than the surveyed date. Before 1938, all OS maps were based on the Cassini Projection, with independent surveys of a single county or group of counties, giving rise to significant inaccuracies in outlying areas. In the late 1940's, a Provisional Edition was produced, which updated the 1:10,560 mapping from a number of sources. The maps appear unfinished - with all military camps and other strategic sites removed. These maps were initially overprinted with the National Grid. In 1970, the first 1:10,000 maps were produced using the Transverse Mercator Projection. The revision process continued until recently, with new editions appearing every 10 years or so for urban areas.

Map Name(s) and Date(s)

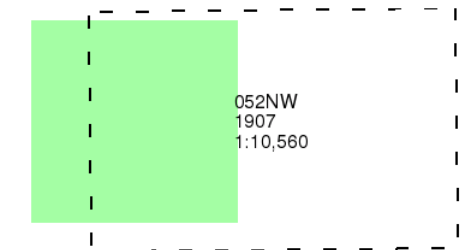

Historical Map - Slice D

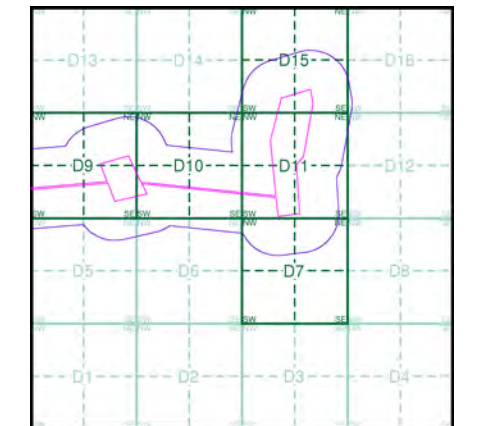

Order Details

Order Number: 297990273_1_1
 Customer Ref: 21-1088.04
 National Grid Reference: 492420, 385520
 Slice: D
 Site Area (Ha): 469.98
 Search Buffer (m): 250

Site Details

Cottam

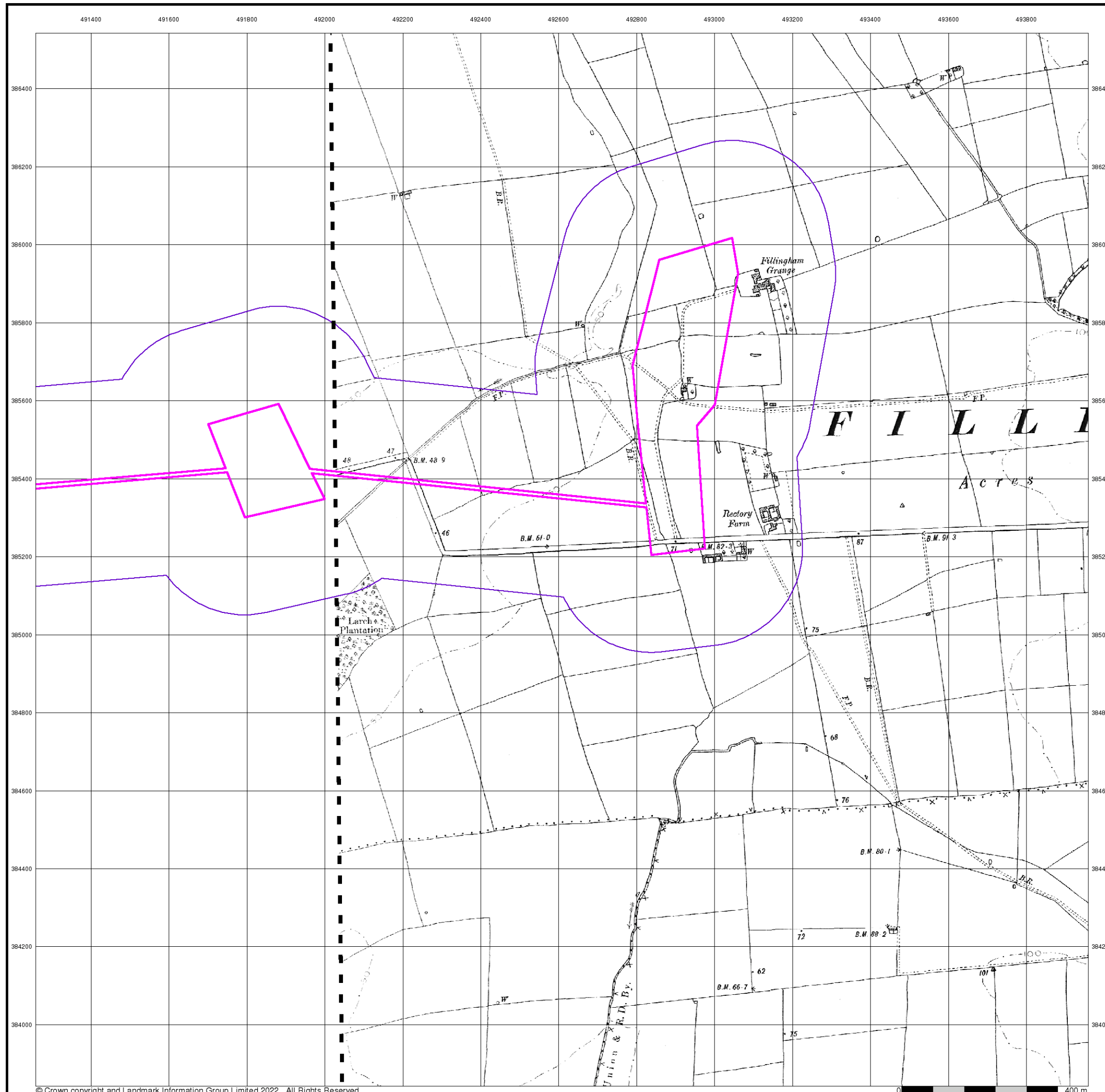

Lincolnshire

Published 1947

Source map scale - 1:10,560

The historical maps shown were reproduced from maps predominantly held at the scale adopted for England, Wales and Scotland in the 1840's. In 1854 the 1:2,500 scale was adopted for mapping urban areas; these maps were used to update the 1:10,560 maps. The published date given therefore is often some years later than the surveyed date. Before 1938, all OS maps were based on the Cassini Projection, with independent surveys of a single county or group of counties, giving rise to significant inaccuracies in outlying areas. In the late 1940's, a Provisional Edition was produced, which updated the 1:10,560 mapping from a number of sources. The maps appear unfinished - with all military camps and other strategic sites removed. These maps were initially overprinted with the National Grid. In 1970, the first 1:10,000 maps were produced using the Transverse Mercator Projection. The revision process continued until recently, with new editions appearing every 10 years or so for urban areas.

Map Name(s) and Date(s)

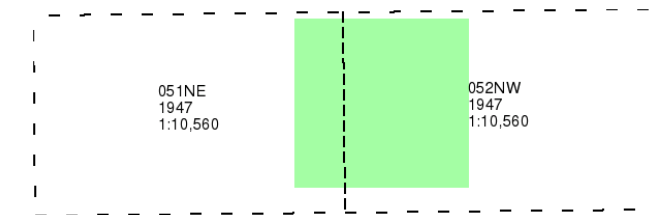

Historical Map - Slice D

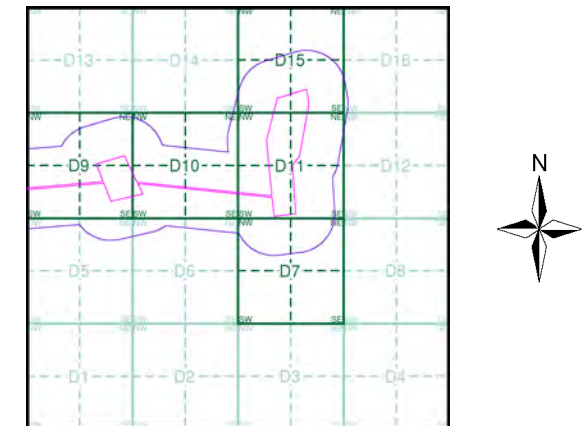

Order Details

Order Number: 297990273_1_1
 Customer Ref: 21-1088.04
 National Grid Reference: 492420, 385520
 Slice: D
 Site Area (Ha): 469.98
 Search Buffer (m): 250

Site Details

Cottam

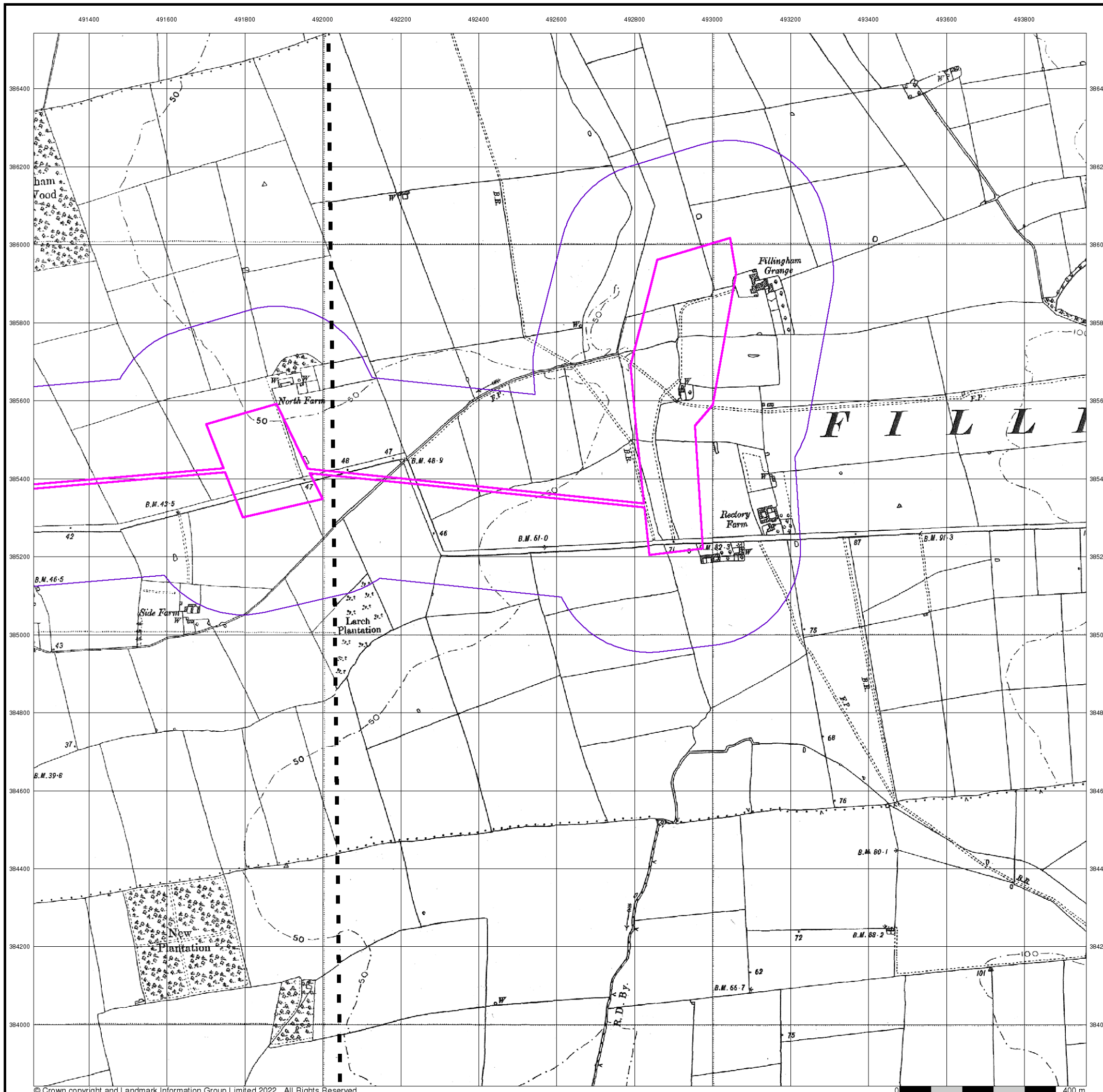

Ordnance Survey Plan

Published 1956

Source map scale - 1:10,000

The historical maps shown were reproduced from maps predominantly held at the scale adopted for England, Wales and Scotland in the 1840's. In 1854 the 1:2,500 scale was adopted for mapping urban areas; these maps were used to update the 1:10,560 maps. The published date given therefore is often some years later than the surveyed date. Before 1938, all OS maps were based on the Cassini Projection, with independent surveys of a single county or group of counties, giving rise to significant inaccuracies in outlying areas. In the late 1940's, a Provisional Edition was produced, which updated the 1:10,560 mapping from a number of sources. The maps appear unfinished - with all military camps and other strategic sites removed. These maps were initially overprinted with the National Grid. In 1970, the first 1:10,000 maps were produced using the Transverse Mercator Projection. The revision process continued until recently, with new editions appearing every 10 years or so for urban areas.

Map Name(s) and Date(s)

SK98NW	1956
1:10,560	
SK98SW	1956
1:10,560	

Historical Map - Slice D

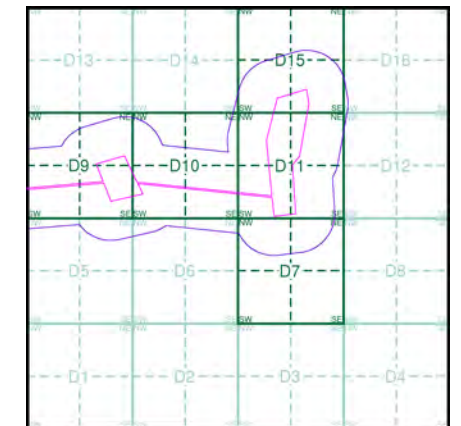

Order Details

Order Number: 297990273_1_1
 Customer Ref: 21-1088.04
 National Grid Reference: 492420, 385520
 Slice: D
 Site Area (Ha): 469.98
 Search Buffer (m): 250

Site Details

Cottam

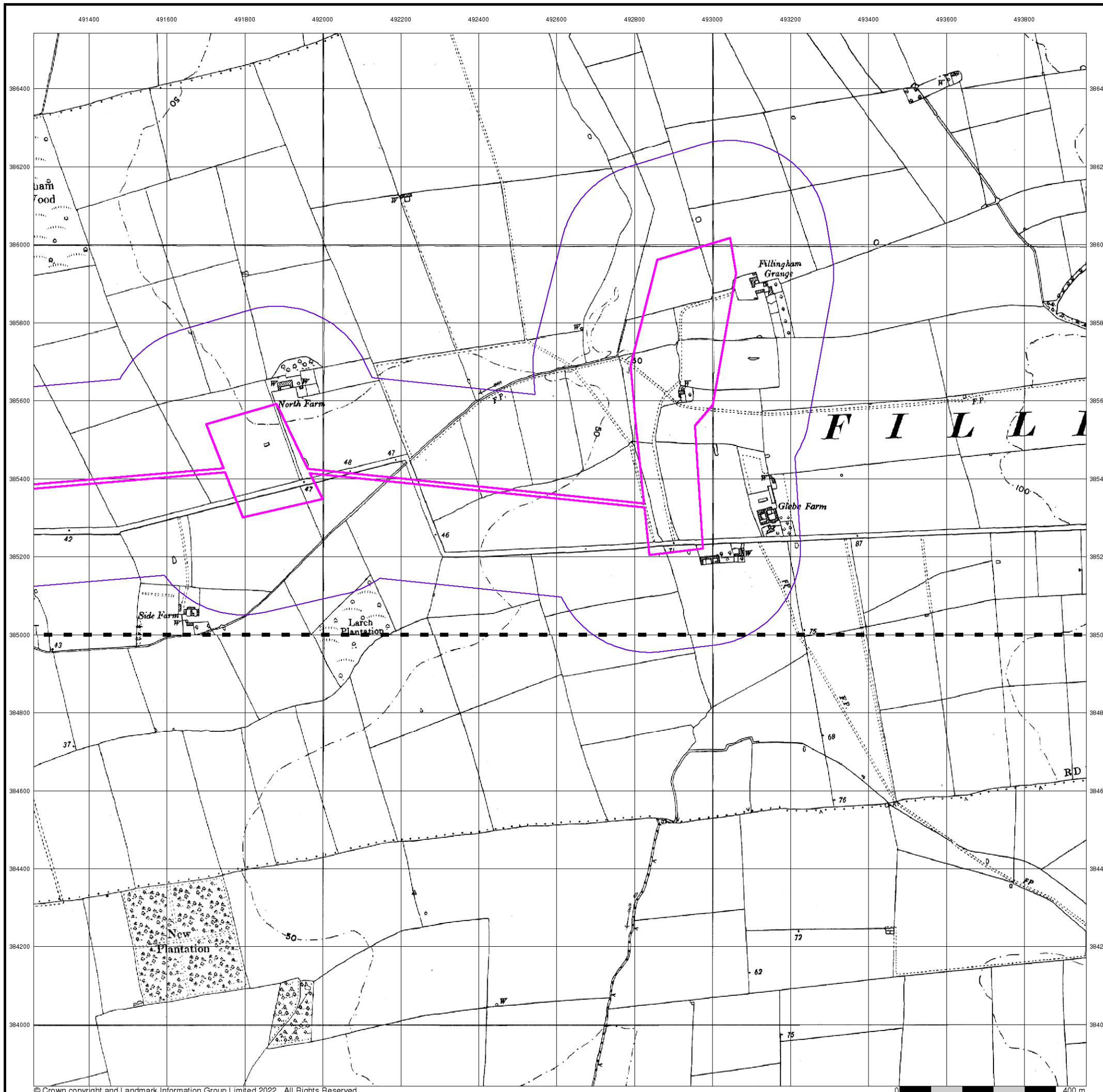

Ordnance Survey Plan

Published 1979

Source map scale - 1:10,000

The historical maps shown were reproduced from maps predominantly held at the scale adopted for England, Wales and Scotland in the 1840's. In 1854 the 1:2,500 scale was adopted for mapping urban areas; these maps were used to update the 1:10,560 maps. The published date given therefore is often some years later than the surveyed date. Before 1938, all OS maps were based on the Cassini Projection, with independent surveys of a single county or group of counties, giving rise to significant inaccuracies in outlying areas. In the late 1940's, a Provisional Edition was produced, which updated the 1:10,560 mapping from a number of sources. The maps appear unfinished - with all military camps and other strategic sites removed. These maps were initially overprinted with the National Grid. In 1970, the first 1:10,000 maps were produced using the Transverse Mercator Projection. The revision process continued until recently, with new editions appearing every 10 years or so for urban areas.

Map Name(s) and Date(s)

SK98NW	1979	1:10,000
SK98SW	1979	1:10,000

Historical Map - Slice D

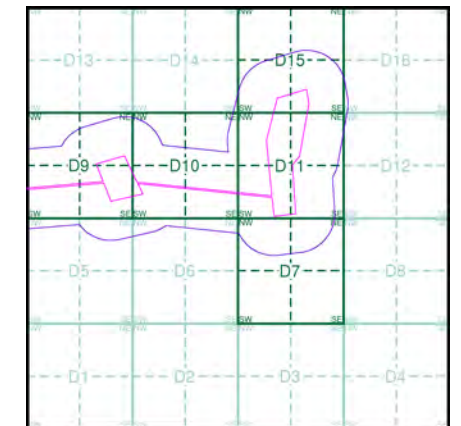

Order Details

Order Number: 297990273_1_1
 Customer Ref: 21-1088.04
 National Grid Reference: 492420, 385520
 Slice: D
 Site Area (Ha): 469.98
 Search Buffer (m): 250

Site Details

Cottam

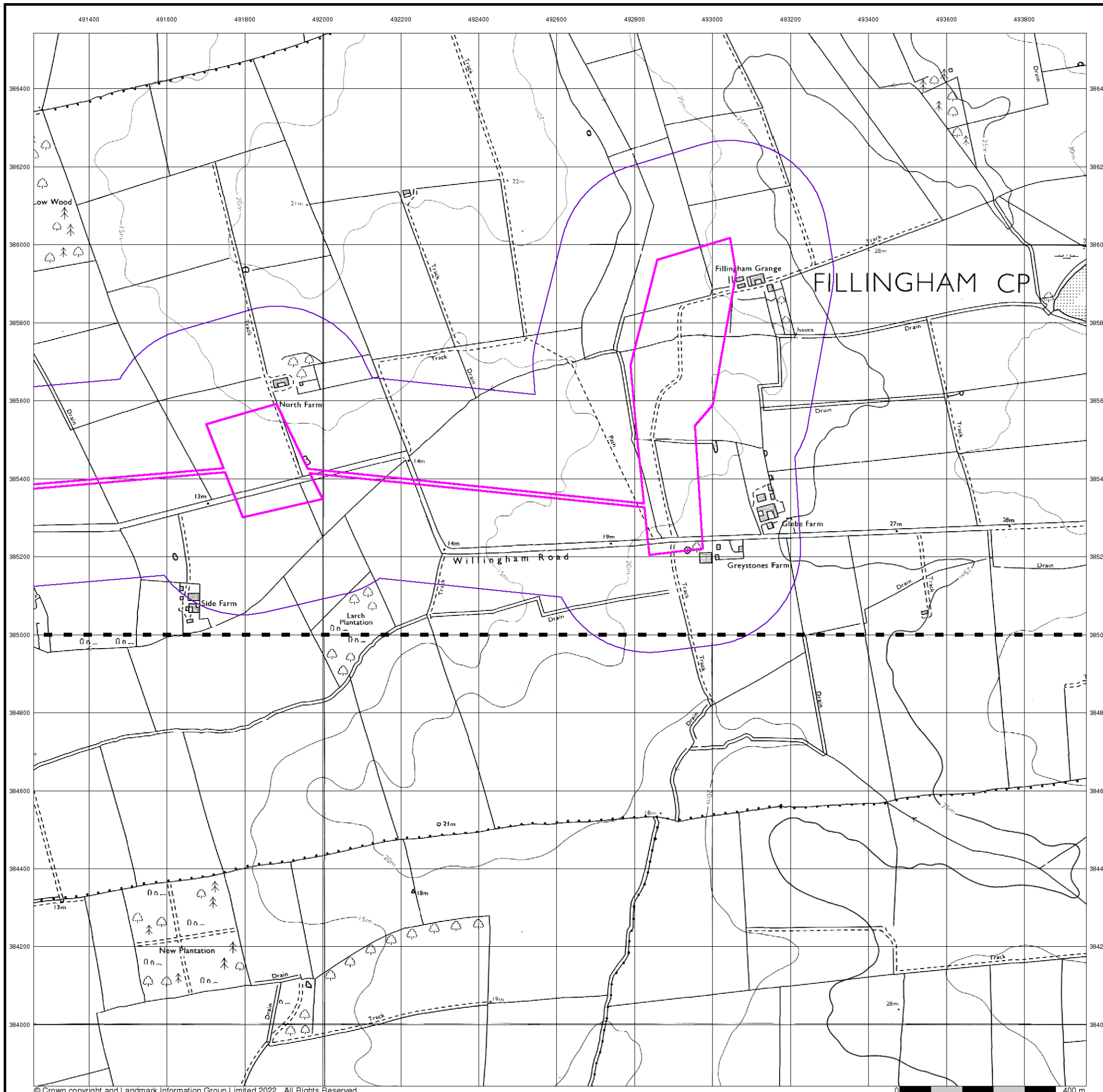

10k Raster Mapping

Published 2000

Source map scale - 1:10,000

The historical maps shown were produced from the Ordnance Survey's 1:10,000 colour raster mapping. These maps are derived from Landplan which replaced the old 1:10,000 maps originally published in 1970. The data is highly detailed showing buildings, fences and field boundaries as well as all roads, tracks and paths. Road names are also included together with the relevant road number and classification. Boundary information depiction includes county, unitary authority, district, civil parish and constituency.

Map Name(s) and Date(s)

SK98NW	2000	1:10,000
SK98SW	2000	1:10,000

Historical Map - Slice D

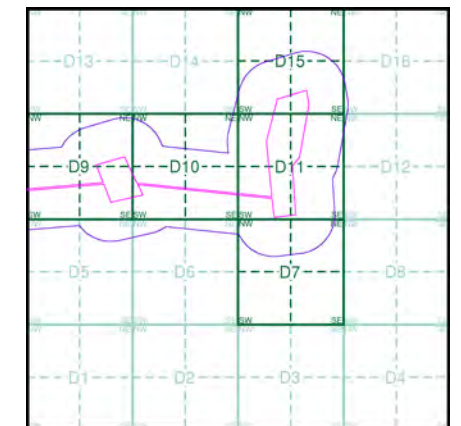

Order Details

Order Number: 297990273_1_1
 Customer Ref: 21-1088.04
 National Grid Reference: 492420, 385520
 Slice: D
 Site Area (Ha): 469.98
 Search Buffer (m): 250

Site Details

Cottam

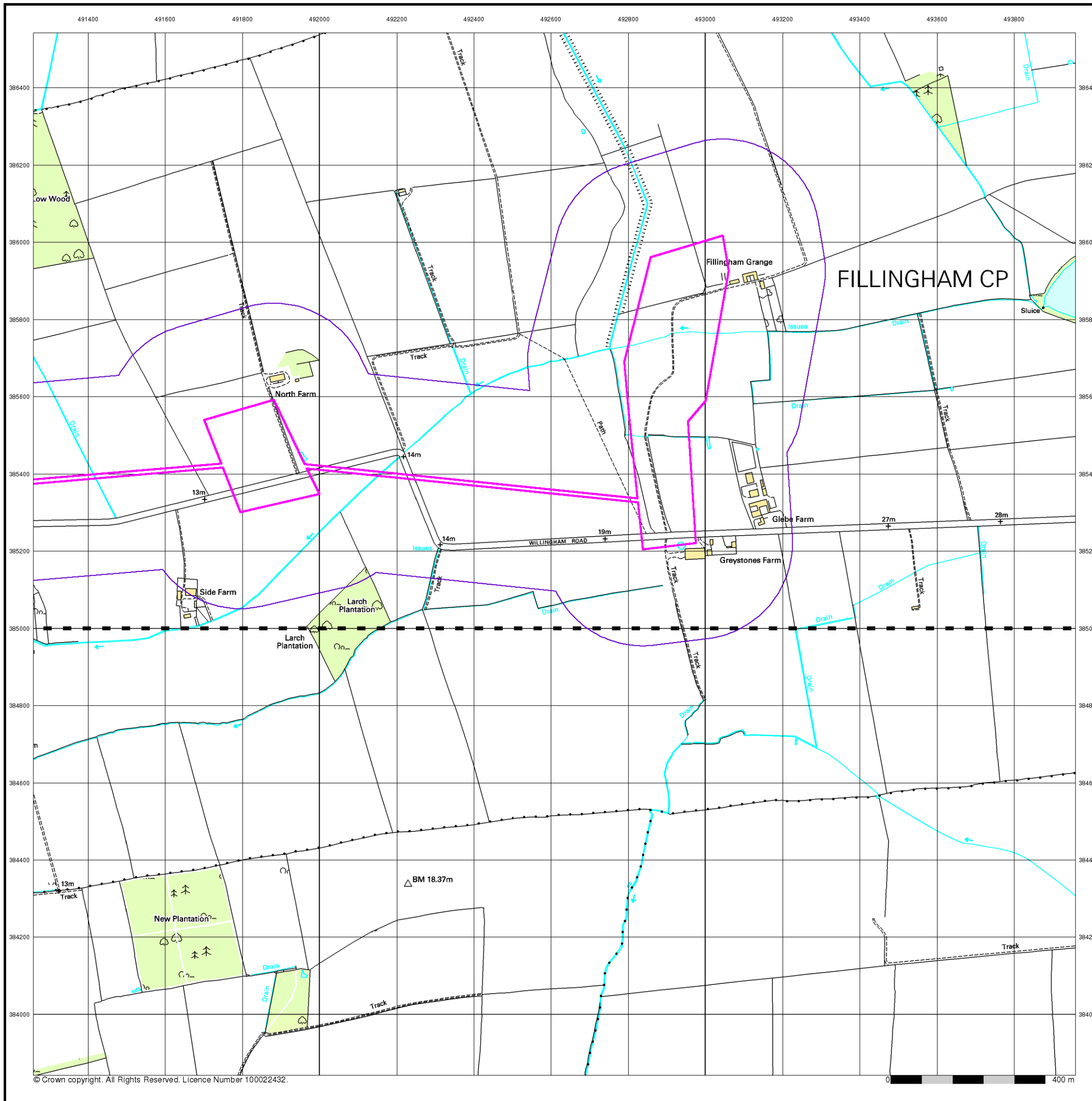

© Crown copyright. All Rights Reserved. Licence Number 100022432.

Street View

Published 2022

Source map scale - 1:10,000

Street View is a street-level map for the whole of Great Britain produced by the Ordnance Survey. These maps are provided at a nominal scale of 1:10,000

Map Name(s) and Date(s)



Street View Map - Slice D

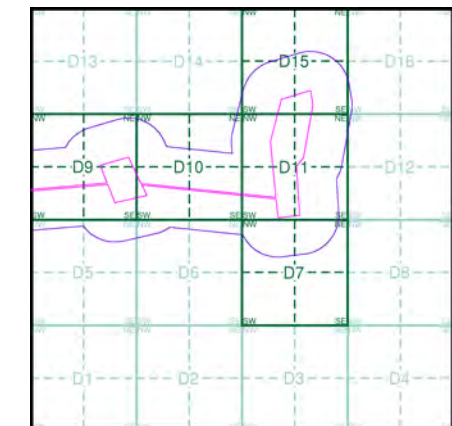

Order Details

Order Number: 297990273_1_1
 Customer Ref: 21-1088.04
 National Grid Reference: 492420, 385520
 Slice: D
 Site Area (Ha): 469.98
 Search Buffer (m): 250

Site Details

Cottam

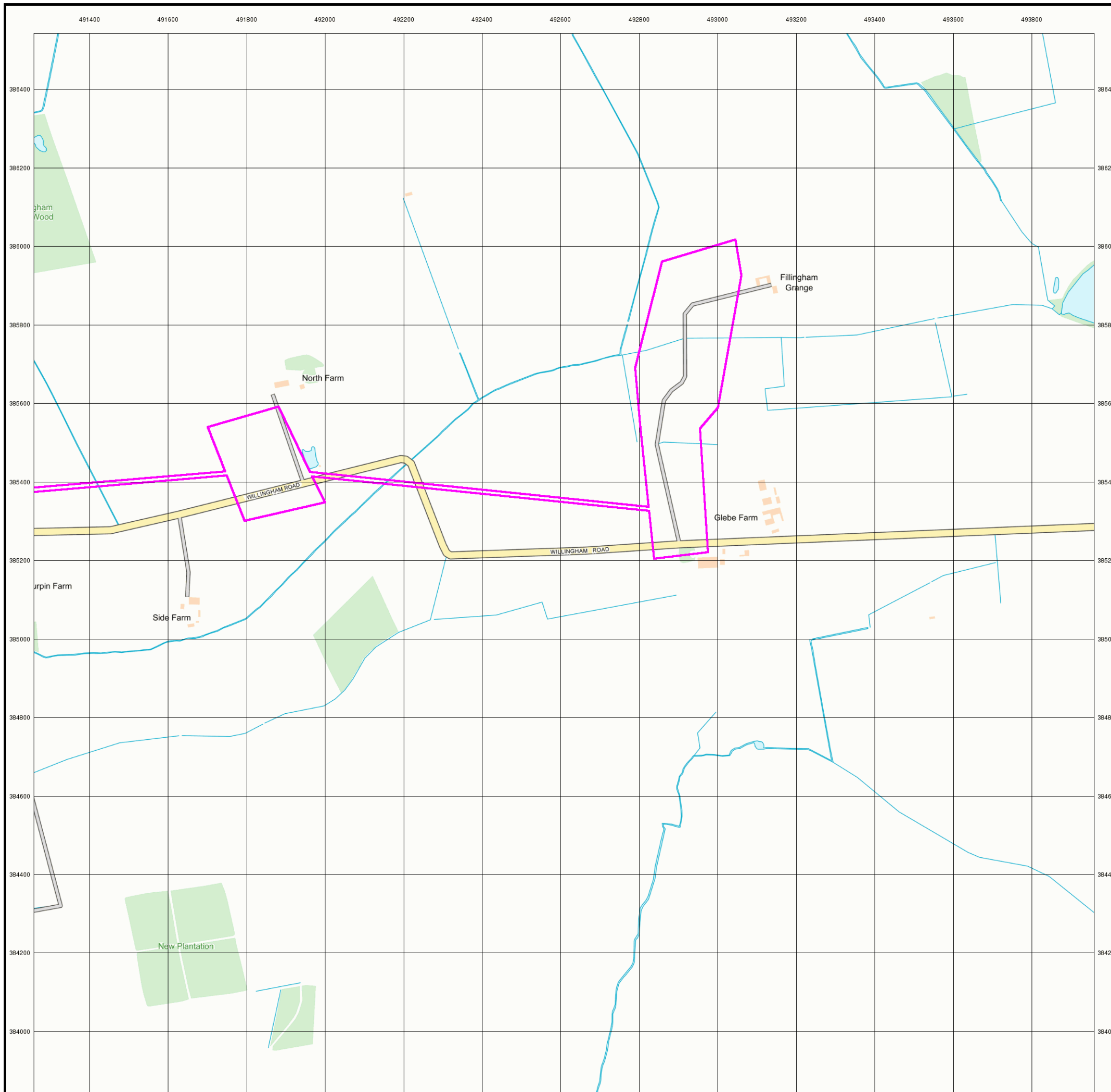

Historical Mapping Legends

Ordnance Survey County Series and Ordnance Survey Plan 1:2,500

Quarry **Gravel Pit** **Sand Pit**
Clay Pit **Shingle** **Refuse Heap**
Sloping Masonry **Flat Rock**
Marsh **Reeds** **Osiers**
Rough Pasture **Furze** **Wood**
Mixed Wood **Brushwood** **Orchard**
Fir **Ford** **Stepping Stones**
Ferry **Waterfall** **Lock**
Trig. Station **Altitude at Trig. Station**
B.M. 325.9 **Bench Mark** **Surface Level**
Arrow denotes flow of water **Antiquities (site of)**
Cutting **Embankment**
Railway crossing Road **Level Crossing** **Road crossing Railway**
Railway crossing River or Canal **Road over single stream** **Road over River or Canal**
County Boundary (Geographical)
County & Civil Parish Boundary
Administrative County & Civil Parish Boundary
County Borough Boundary (England)
Co. Boro. Bdy.
County Burgh Boundary (Scotland)
Boundary Post or Stone **Police Call Box**
B.R. **Bridle Road** **P** **Pump**
E.P. **Electricity Pylon** **S.P.** **Signal Post**
F.B. **Foot Bridge** **Sl.** **Sluice**
F.P. **Foot Path** **Sp.** **Spring**
G.P. **Guide Post or Board** **T.C.B.** **Telephone Call Box**
M.S. **Mile Stone** **Tr.** **Trough**
M.P. M.R. **Mooring Post or Ring** **W** **Well**

Ordnance Survey Plan, Additional SIMs and Supply of Unpublished Survey Information 1:2,500 and 1:1,250

Inactive Quarry, Chalk Pit or Clay Pit **Active Quarry, Chalk Pit or Clay Pit**
Rock **Boulders**
Cliff **Slopes** **Top**
Roofed Building **Glazed Roof Building**
Sloping Masonry **Archway**
Non-Coniferous Tree (surveyed) **Coniferous Tree (surveyed)**
Non-Coniferous Trees (not surveyed) **Coniferous Trees (not surveyed)**
Orchard Tree **Scrub** **Bracken**
Coppice, Osier **Reeds** **Marsh, Saltings**
Rough Grassland **Heath** **Culvert**
Direction of water flow **Bench Mark** **Antiquity (site of)**
Cave Entrance **Triangulation Station** **Electricity Pylon**
Electricity Transmission Line
County Boundary (Geographical)
County & Civil Parish Boundary
Civil Parish Boundary
Admin. County or County Bor. Boundary
London Borough Boundary
Symbol marking point where boundary mereing changes
BH **Beer House** **P** **Pillar, Pole or Post**
BP, BS **Boundary Post or Stone** **PO** **Post Office**
Cn, C **Capstan, Crane** **PC** **Public Convenience**
Chy **Chimney** **PH** **Public House**
D Fn **Drinking Fountain** **Pp** **Pump**
EI P **Electricity Pillar or Post** **SB, S Br** **Signal Box or Bridge**
FAP **Fire Alarm Pillar** **SP, SL** **Signal Post or Light**
FB **Foot Bridge** **Spr** **Spring**
GP **Guide Post** **Tk** **Tank or Track**
H **Hydrant or Hydraulic** **TCB** **Telephone Call Box**
LC **Level Crossing** **TCP** **Telephone Call Post**
MH **Manhole** **Tr** **Trough**
MP **Mile Post or Mooring Post** **Wr Pt, Wr T** **Water Point, Water Tap**
MS **Mile Stone** **W** **Well**
NTL **Normal Tidal Limit** **Wd Pp** **Wind Pump**

Large-Scale National Grid Data 1:2,500 and 1:1,250

Cliff **Slopes** **Top**
Rock **Rock (scattered)**
Boulders **Boulders (scattered)**
Positioned Boulder **Scree**
Non-Coniferous Tree (surveyed) **Coniferous Tree (surveyed)**
Non-Coniferous Trees (not surveyed) **Coniferous Trees (not surveyed)**
Orchard Tree **Scrub** **Bracken**
Coppice, Osier **Reeds** **Marsh, Saltings**
Rough Grassland **Heath** **Culvert**
Direction of water flow **Triangulation Station** **Antiquity (site of)**
Electricity Transmission Line **Electricity Pylon**
B.M. 231.60m **Bench Mark** **Buildings with Building Seed**
Roofed Building **Glazed Roof Building**
Civil parish/community boundary
District boundary
County boundary
Boundary post/stone
Boundary mereing symbol (note: these always appear in opposed pairs or groups of three)
Bks **Barracks** **P** **Pillar, Pole or Post**
Bty **Battery** **PO** **Post Office**
Cemy **Cemetery** **PC** **Public Convenience**
Chy **Chimney** **Pp** **Pump**
Cis **Cistern** **Ppg Sta** **Pumping Station**
Dismtd Rly **Dismantled Railway** **PW** **Place of Worship**
EI Gen Sta **Electricity Generating Station** **Sewage Ppg Sta** **Sewage Pumping Station**
EI P **Electricity Pole, Pillar** **SB, S Br** **Signal Box or Bridge**
EI Sub Sta **Electricity Sub Station** **SP, SL** **Signal Post or Light**
FB **Filter Bed** **Spr** **Spring**
Fn / D Fn **Fountain / Drinking Ftn.** **Tk** **Tank or Track**
Gas Gov **Gas Valve Compound** **Tr** **Trough**
GVC **Gas Governor** **Wd Pp** **Wind Pump**
GP **Guide Post** **Wr Pt, Wr T** **Water Point, Water Tap**
MH **Manhole** **Wks** **Works (building or area)**
MP, MS **Mile Post or Mile Stone** **W** **Well**



Historical Mapping & Photography included:

Mapping Type	Scale	Date	Pg
Lincolnshire	1:2,500	1886	2
Lincolnshire	1:2,500	1906	3
Ordnance Survey Plan	1:2,500	1974	4
Large-Scale National Grid Data	1:2,500	1994	5

Historical Map - Segment D7

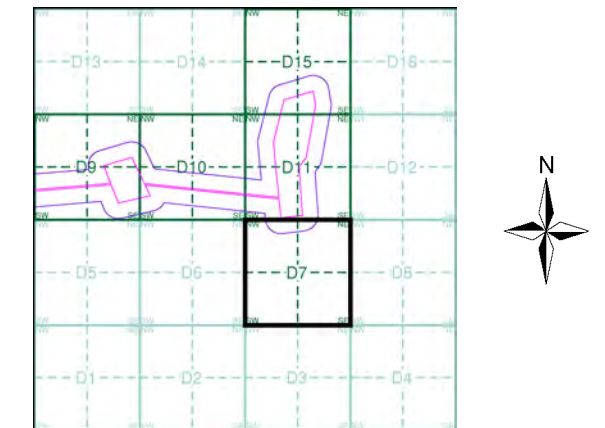

Order Details

Order Number: 297990273_1_1
 Customer Ref: 21-1088.04
 National Grid Reference: 492420, 385520
 Slice: D
 Site Area (Ha): 469.98
 Search Buffer (m): 100

Site Details

Cottam



Tel: [Redacted]
 Fax: [Redacted]
 Web: [Redacted]

Lincolnshire

Published 1886

Source map scale - 1:2,500

The historical maps shown were reproduced from maps predominantly held at the scale adopted for England, Wales and Scotland in the 1840's. In 1854 the 1:2,500 scale was adopted for mapping urban areas and by 1896 it covered the whole of what were considered to be the cultivated parts of Great Britain. The published date given below is often some years later than the surveyed date. Before 1938, all OS maps were based on the Cassini Projection, with independent surveys of a single county or group of counties, giving rise to significant inaccuracies in outlying areas.

Map Name(s) and Date(s)

052_01
1886
1:2,500
052_05
1886
1:2,500

Historical Map - Segment D7

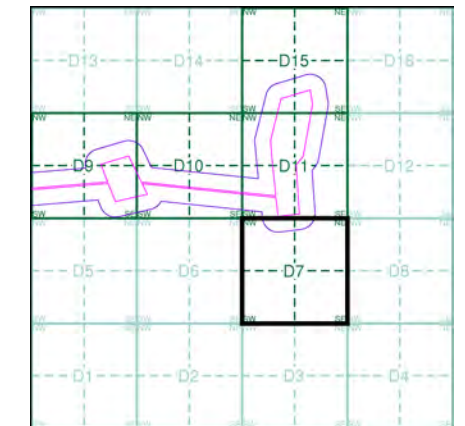

Order Details

Order Number: 297990273_1_1
 Customer Ref: 21-1088.04
 National Grid Reference: 492420, 385520
 Slice: D
 Site Area (Ha): 469.98
 Search Buffer (m): 100

Site Details

Cottam

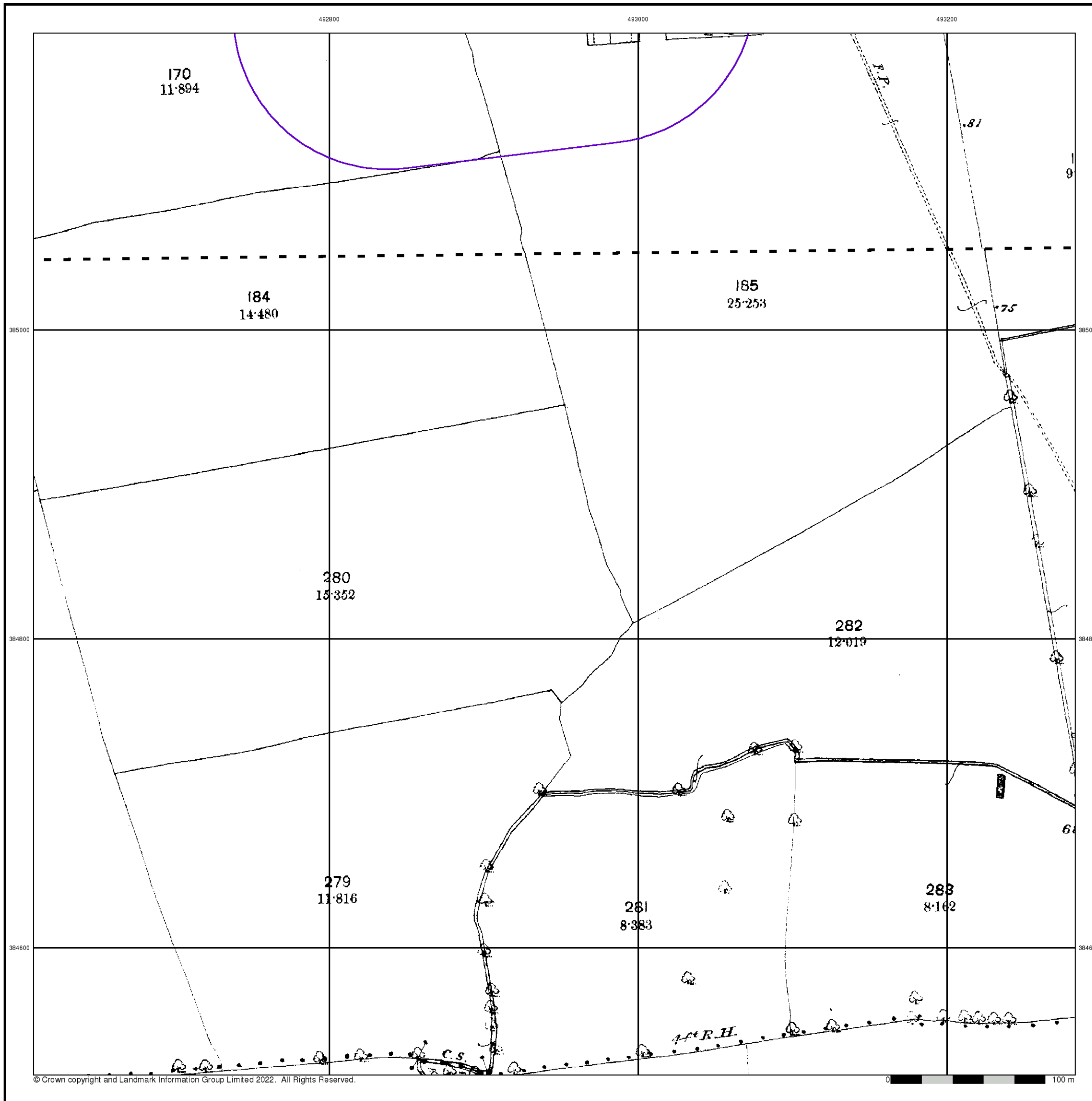

Lincolnshire

Published 1906

Source map scale - 1:2,500

The historical maps shown were reproduced from maps predominantly held at the scale adopted for England, Wales and Scotland in the 1840's. In 1854 the 1:2,500 scale was adopted for mapping urban areas and by 1896 it covered the whole of what were considered to be the cultivated parts of Great Britain. The published date given below is often some years later than the surveyed date. Before 1938, all OS maps were based on the Cassini Projection, with independent surveys of a single county or group of counties, giving rise to significant inaccuracies in outlying areas.

Map Name(s) and Date(s)

052_01
1906
1:2,500
052_05
1906
1:2,500

Historical Map - Segment D7

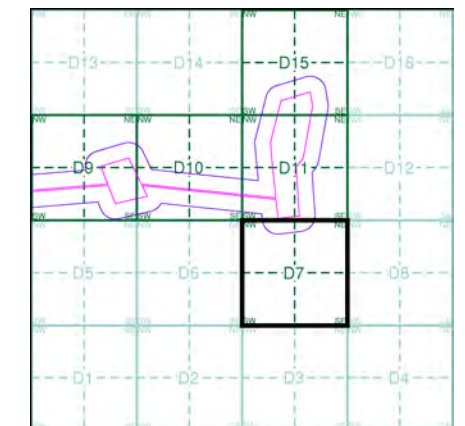

Order Details

Order Number: 297990273_1_1
 Customer Ref: 21-1088.04
 National Grid Reference: 492420, 385520
 Slice: D
 Site Area (Ha): 469.98
 Search Buffer (m): 100

Site Details

Cottam

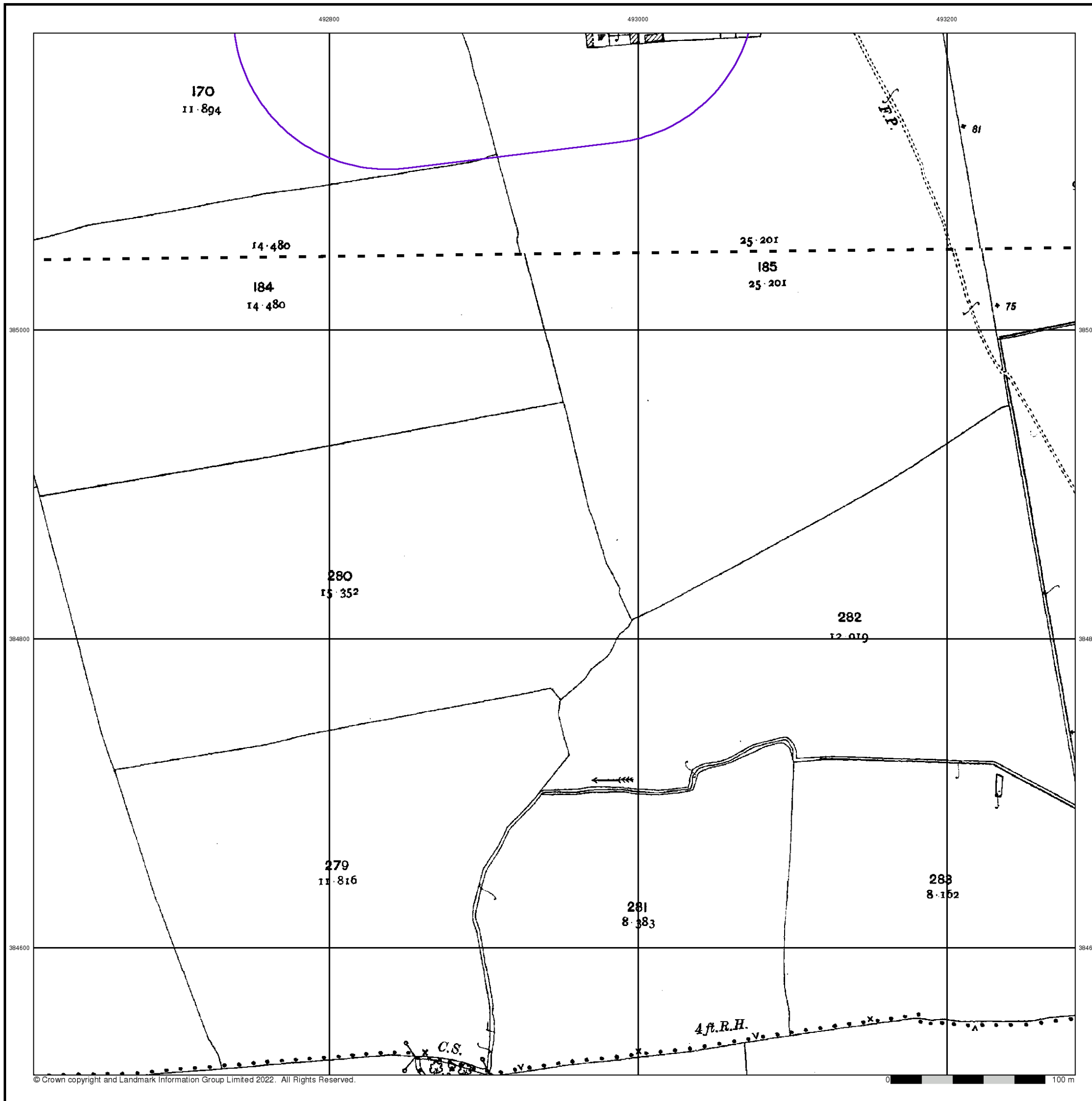

Ordnance Survey Plan

Published 1974

Source map scale - 1:2,500

The historical maps shown were reproduced from maps predominantly held at the scale adopted for England, Wales and Scotland in the 1840's. In 1854 the 1:2,500 scale was adopted for mapping urban areas and by 1896 it covered the whole of what were considered to be the cultivated parts of Great Britain. The published date given below is often some years later than the surveyed date. Before 1938, all OS maps were based on the Cassini Projection, with independent surveys of a single county or group of counties, giving rise to significant inaccuracies in outlying areas.

Map Name(s) and Date(s)

SK9285 1974 12,500	SK9385 1974 12,500
SK9284 1974 12,500	SK9384 1974 12,500

Historical Map - Segment D7

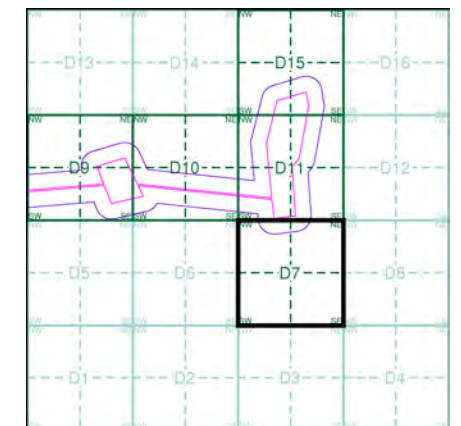

Order Details

Order Number: 297990273_1_1
 Customer Ref: 21-1088.04
 National Grid Reference: 492420, 385520
 Slice: D
 Site Area (Ha): 469.98
 Search Buffer (m): 100

Site Details

Cottam

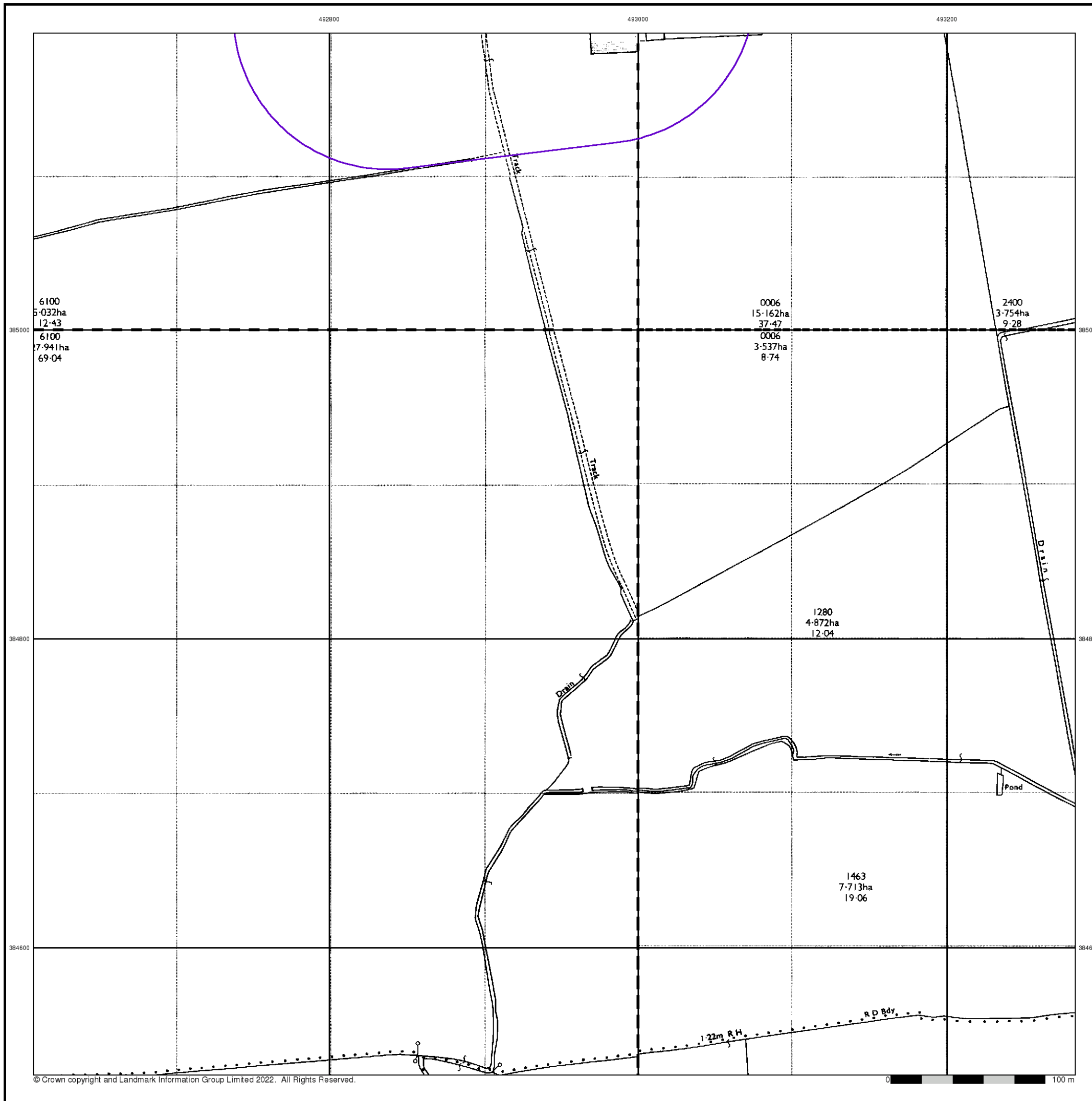

Large-Scale National Grid Data

Published 1994

Source map scale - 1:2,500

'Large Scale National Grid Data' superseded SIM cards (Ordnance Survey's 'Survey of Information on Microfilm') in 1992, and continued to be produced until 1999. These maps were the fore-runners of digital mapping and so provide detailed information on houses and roads, but tend to show less topographic features such as vegetation. These maps were produced at both 1:2,500 and 1:1,250 scales.

Map Name(s) and Date(s)

SK9285 1994 1:2,500	SK9385 1994 1:2,500
SK9284 1994 1:2,500	SK9384 1994 1:2,500

Historical Map - Segment D7

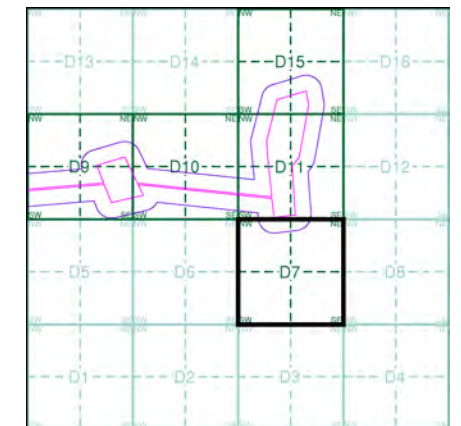

Order Details

Order Number: 297990273_1_1
 Customer Ref: 21-1088.04
 National Grid Reference: 492420, 385520
 Slice: D
 Site Area (Ha): 469.98
 Search Buffer (m): 100

Site Details

Cottam

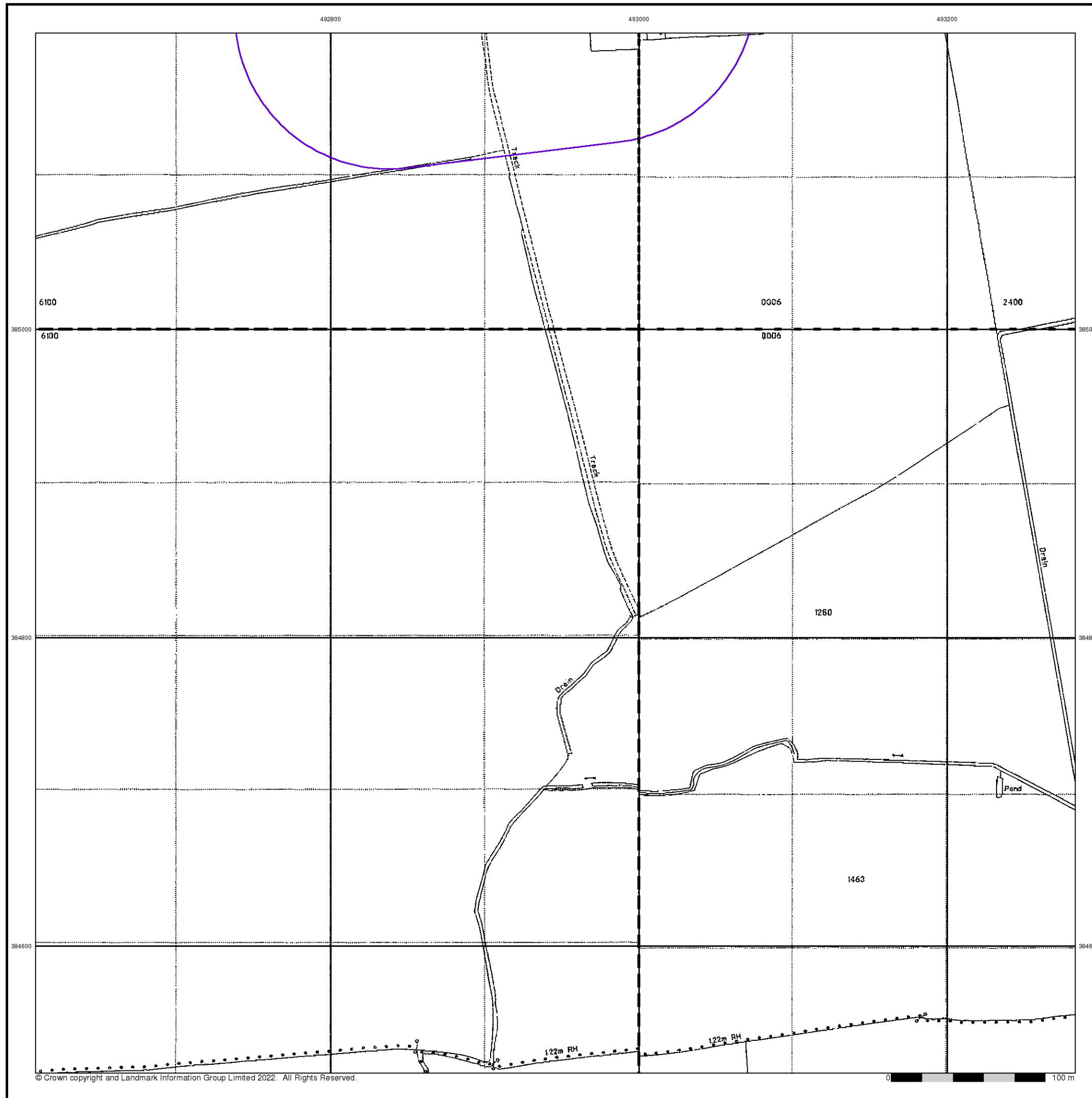

Historical Mapping Legends

Ordnance Survey County Series and Ordnance Survey Plan 1:2,500

Quarry **Gravel Pit** **Sand Pit**
Clay Pit **Shingle** **Refuse Heap**
Sloping Masonry **Flat Rock**
Marsh **Reeds** **Osiers**
Rough Pasture **Furze** **Wood**
Mixed Wood **Brushwood** **Orchard**
Fir **Ford** **Stepping Stones**
Ferry **Waterfall** **Lock**
Trig. Station **Altitude at Trig. Station**
B.M. 325.9 **Bench Mark** **Surface Level**
Arrow denotes flow of water **Antiquities (site of)**
Cutting **Embankment**
Railway crossing Road **Level Crossing** **Road crossing Railway**
Railway crossing River or Canal **Road over single stream** **Road over River or Canal**
County Boundary (Geographical)
County & Civil Parish Boundary
Administrative County & Civil Parish Boundary
County Borough Boundary (England)
Co. Boro. Bdy.
County Burgh Boundary (Scotland)
Boundary Post or Stone **Police Call Box**
B.R. **Bridle Road** **P** **Pump**
E.P. **Electricity Pylon** **S.P.** **Signal Post**
F.B. **Foot Bridge** **Sl.** **Sluice**
F.P. **Foot Path** **Sp.** **Spring**
G.P. **Guide Post or Board** **T.C.B.** **Telephone Call Box**
M.S. **Mile Stone** **Tr.** **Trough**
M.P. M.R. **Mooring Post or Ring** **W** **Well**

Ordnance Survey Plan, Additional SIMs and Supply of Unpublished Survey Information 1:2,500 and 1:1,250

Inactive Quarry, Chalk Pit or Clay Pit **Active Quarry, Chalk Pit or Clay Pit**
Rock **Boulders**
Cliff **Slopes** **Top**
Roofed Building **Glazed Roof Building**
Sloping Masonry **Archway**
Non-Coniferous Tree (surveyed) **Coniferous Tree (surveyed)**
Non-Coniferous Trees (not surveyed) **Coniferous Trees (not surveyed)**
Orchard Tree **Scrub** **Bracken**
Coppice, Osier **Reeds** **Marsh, Saltings**
Rough Grassland **Heath** **Culvert**
Direction of water flow **Bench Mark** **Antiquity (site of)**
Cave Entrance **Triangulation Station** **Electricity Pylon**
Electricity Transmission Line
County Boundary (Geographical)
County & Civil Parish Boundary
Civil Parish Boundary
Admin. County or County Bor. Boundary
London Borough Boundary
Symbol marking point where boundary mereing changes
BH **Beer House** **P** **Pillar, Pole or Post**
BP, BS **Boundary Post or Stone** **PO** **Post Office**
Cn, C **Capstan, Crane** **PC** **Public Convenience**
Chy **Chimney** **PH** **Public House**
D Fn **Drinking Fountain** **Pp** **Pump**
EI P **Electricity Pillar or Post** **SB, S Br** **Signal Box or Bridge**
FAP **Fire Alarm Pillar** **SP, SL** **Signal Post or Light**
FB **Foot Bridge** **Spr** **Spring**
GP **Guide Post** **Tk** **Tank or Track**
H **Hydrant or Hydraulic** **TCB** **Telephone Call Box**
LC **Level Crossing** **TCP** **Telephone Call Post**
MH **Manhole** **Tr** **Trough**
MP **Mile Post or Mooring Post** **Wr Pt, Wr T** **Water Point, Water Tap**
MS **Mile Stone** **W** **Well**
NTL **Normal Tidal Limit** **Wd Pp** **Wind Pump**

Large-Scale National Grid Data 1:2,500 and 1:1,250

Cliff **Slopes** **Top**
Rock **Rock (scattered)**
Boulders **Boulders (scattered)**
Positioned Boulder **Scree**
Non-Coniferous Tree (surveyed) **Coniferous Tree (surveyed)**
Non-Coniferous Trees (not surveyed) **Coniferous Trees (not surveyed)**
Orchard Tree **Scrub** **Bracken**
Coppice, Osier **Reeds** **Marsh, Saltings**
Rough Grassland **Heath** **Culvert**
Direction of water flow **Triangulation Station** **Antiquity (site of)**
Electricity Transmission Line **Electricity Pylon**
B.M. 231.60m **Bench Mark** **Buildings with Building Seed**
Roofed Building **Glazed Roof Building**
Civil parish/community boundary
District boundary
County boundary
Boundary post/stone
Boundary mereing symbol (note: these always appear in opposed pairs or groups of three)
Bks **Barracks** **P** **Pillar, Pole or Post**
Bty **Battery** **PO** **Post Office**
Cemy **Cemetery** **PC** **Public Convenience**
Chy **Chimney** **Pp** **Pump**
Cis **Cistern** **Ppg Sta** **Pumping Station**
Dismtd Rly **Dismantled Railway** **PW** **Place of Worship**
EI Gen Sta **Electricity Generating Station** **Sewage Ppg Sta** **Sewage Pumping Station**
EI P **Electricity Pole, Pillar** **SB, S Br** **Signal Box or Bridge**
EI Sub Sta **Electricity Sub Station** **SP, SL** **Signal Post or Light**
FB **Filter Bed** **Spr** **Spring**
Fn / D Fn **Fountain / Drinking Ftn.** **Tk** **Tank or Track**
Gas Gov **Gas Valve Compound** **Tr** **Trough**
GVC **Gas Governor** **Wd Pp** **Wind Pump**
GP **Guide Post** **Wr Pt, Wr T** **Water Point, Water Tap**
MH **Manhole** **Wks** **Works (building or area)**
MP, MS **Mile Post or Mile Stone** **W** **Well**



Historical Mapping & Photography included:

Mapping Type	Scale	Date	Pg
Lincolnshire	1:2,500	1886	2
Lincolnshire	1:2,500	1906	3
Ordnance Survey Plan	1:2,500	1974	4
Large-Scale National Grid Data	1:2,500	1994	5

Historical Map - Segment D9

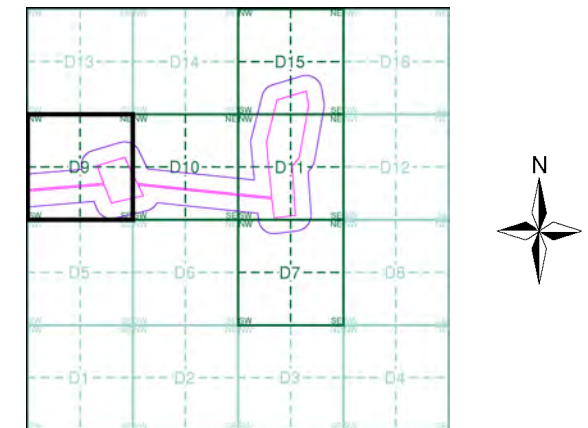

Order Details

Order Number: 297990273_1_1
 Customer Ref: 21-1088.04
 National Grid Reference: 492420, 385520
 Slice: D
 Site Area (Ha): 469.98
 Search Buffer (m): 100

Site Details

Cottam



Tel:
Fax:
Web:

Lincolnshire

Published 1886

Source map scale - 1:2,500

The historical maps shown were reproduced from maps predominantly held at the scale adopted for England, Wales and Scotland in the 1840's. In 1854 the 1:2,500 scale was adopted for mapping urban areas and by 1896 it covered the whole of what were considered to be the cultivated parts of Great Britain. The published date given below is often some years later than the surveyed date. Before 1938, all OS maps were based on the Cassini Projection, with independent surveys of a single county or group of counties, giving rise to significant inaccuracies in outlying areas.

Map Name(s) and Date(s)

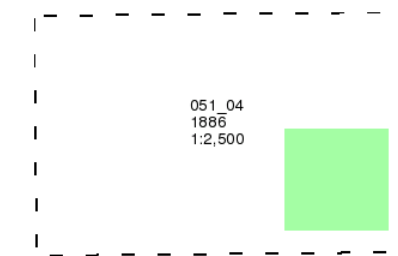

Historical Map - Segment D9

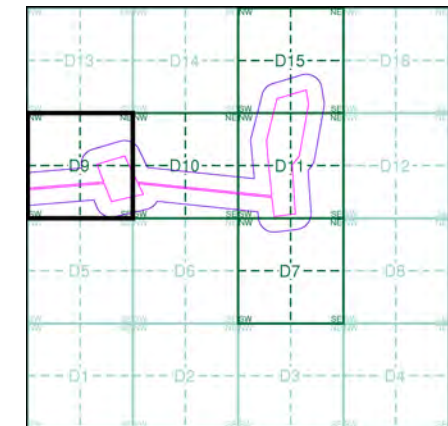

Order Details

Order Number: 297990273_1_1
 Customer Ref: 21-1088.04
 National Grid Reference: 492420, 385520
 Slice: D
 Site Area (Ha): 469.98
 Search Buffer (m): 100

Site Details

Cottam

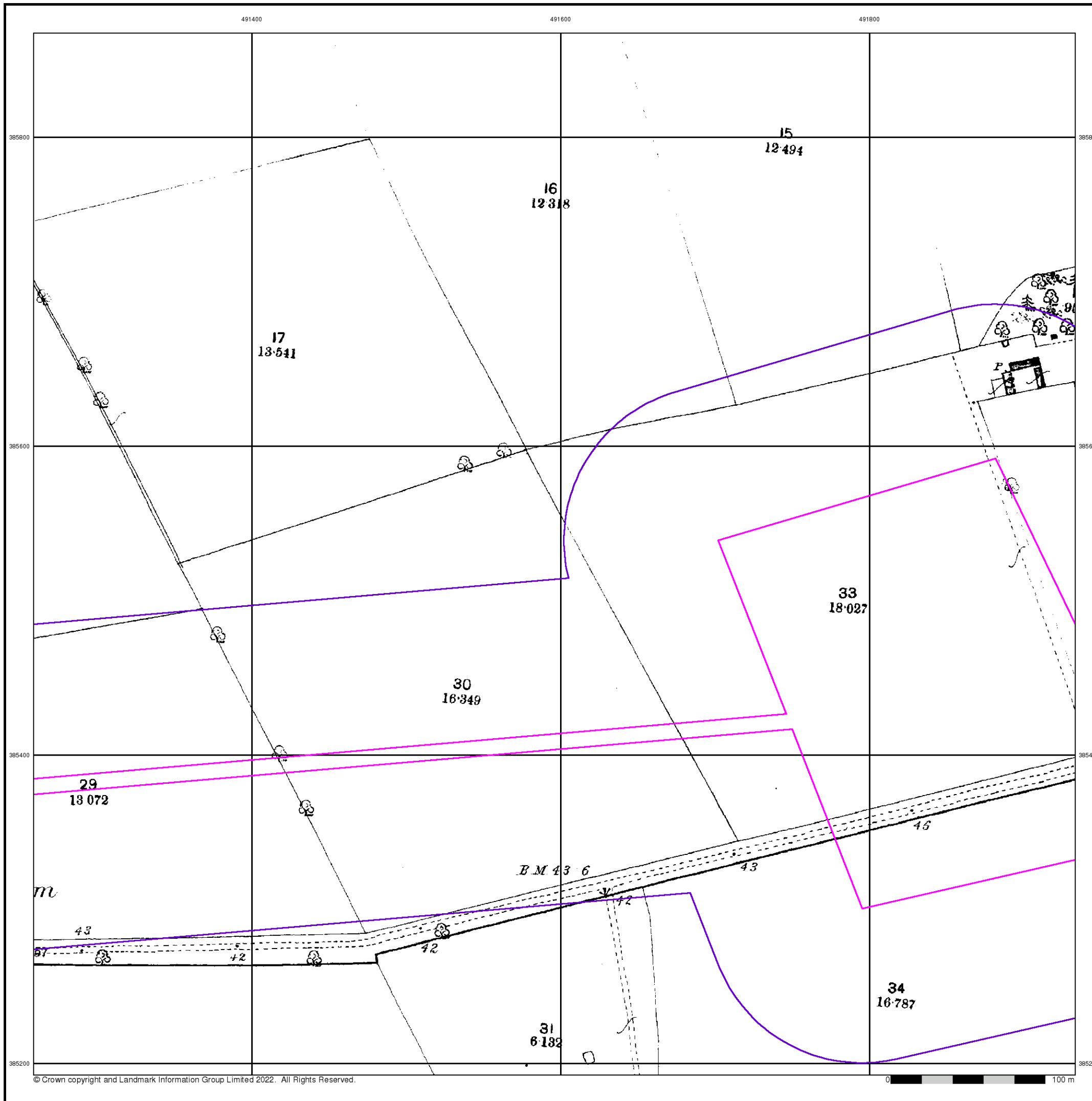

Lincolnshire

Published 1906

Source map scale - 1:2,500

The historical maps shown were reproduced from maps predominantly held at the scale adopted for England, Wales and Scotland in the 1840's. In 1854 the 1:2,500 scale was adopted for mapping urban areas and by 1896 it covered the whole of what were considered to be the cultivated parts of Great Britain. The published date given below is often some years later than the surveyed date. Before 1938, all OS maps were based on the Cassini Projection, with independent surveys of a single county or group of counties, giving rise to significant inaccuracies in outlying areas.

Map Name(s) and Date(s)

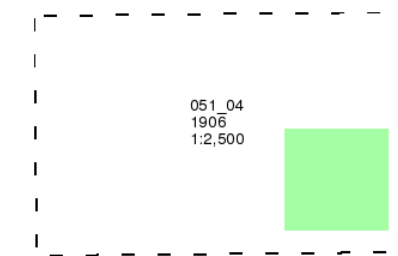

Historical Map - Segment D9

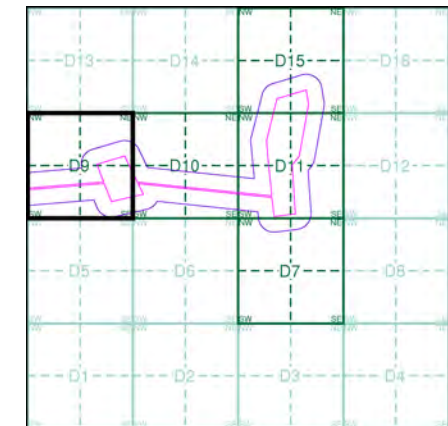

Order Details

Order Number: 297990273_1_1
 Customer Ref: 21-1088.04
 National Grid Reference: 492420, 385520
 Slice: D
 Site Area (Ha): 469.98
 Search Buffer (m): 100

Site Details

Cottam

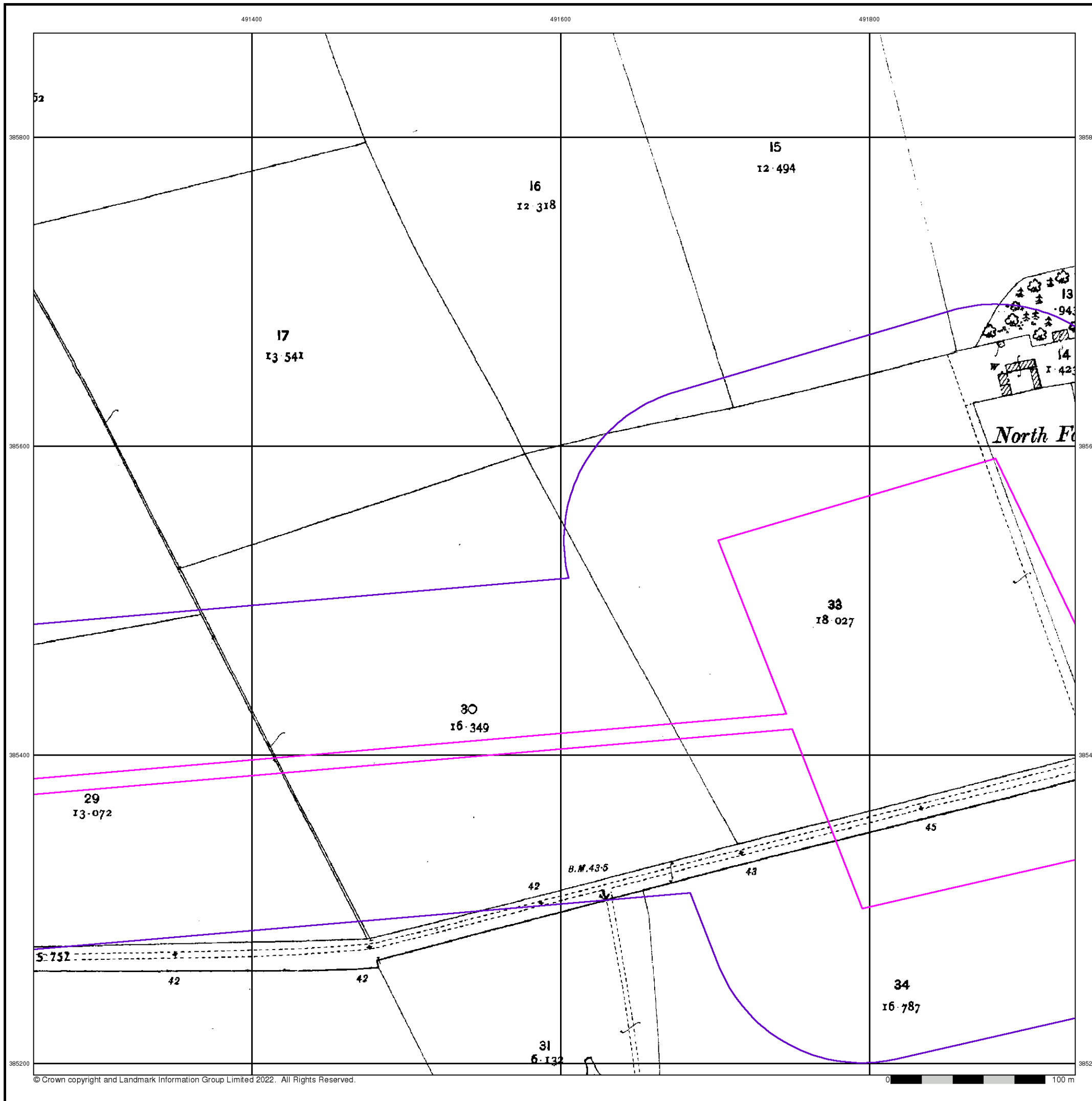

Ordnance Survey Plan

Published 1974

Source map scale - 1:2,500

The historical maps shown were reproduced from maps predominantly held at the scale adopted for England, Wales and Scotland in the 1840's. In 1854 the 1:2,500 scale was adopted for mapping urban areas and by 1896 it covered the whole of what were considered to be the cultivated parts of Great Britain. The published date given below is often some years later than the surveyed date. Before 1938, all OS maps were based on the Cassini Projection, with independent surveys of a single county or group of counties, giving rise to significant inaccuracies in outlying areas.

Map Name(s) and Date(s)

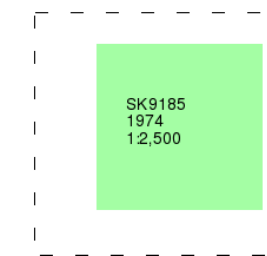

Historical Map - Segment D9

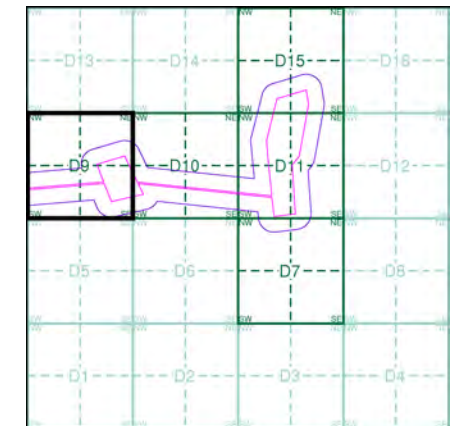

Order Details

Order Number: 297990273_1_1
 Customer Ref: 21-1088.04
 National Grid Reference: 492420, 385520
 Slice: D
 Site Area (Ha): 469.98
 Search Buffer (m): 100

Site Details

Cottam

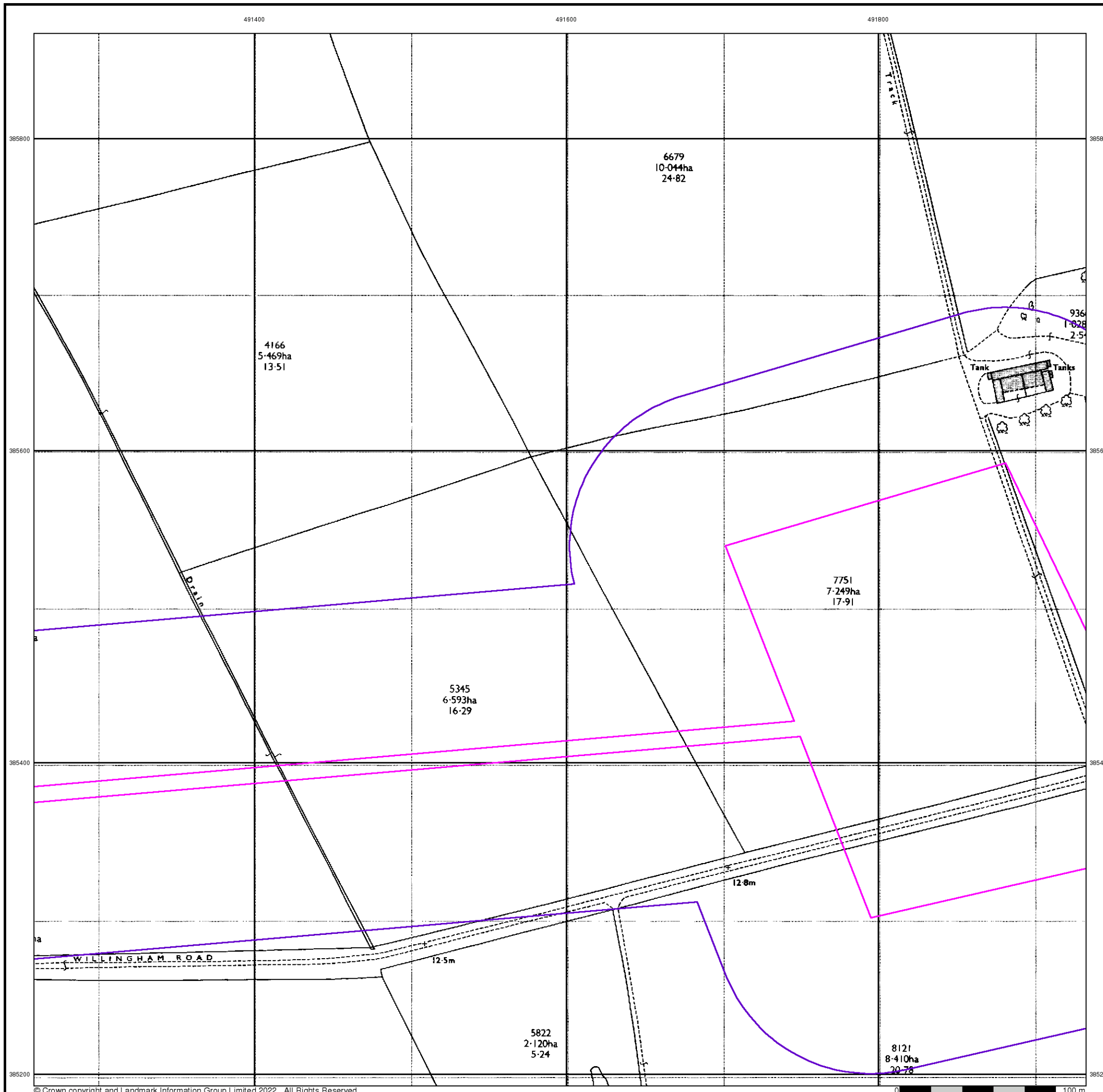

Large-Scale National Grid Data

Published 1994

Source map scale - 1:2,500

'Large Scale National Grid Data' superseded SIM cards (Ordnance Survey's 'Survey of Information on Microfilm') in 1992, and continued to be produced until 1999. These maps were the fore-runners of digital mapping and so provide detailed information on houses and roads, but tend to show less topographic features such as vegetation. These maps were produced at both 1:2,500 and 1:1,250 scales.

Map Name(s) and Date(s)

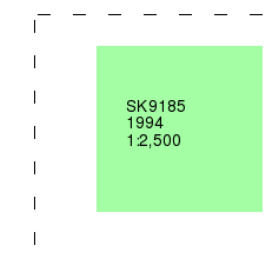

Historical Map - Segment D9

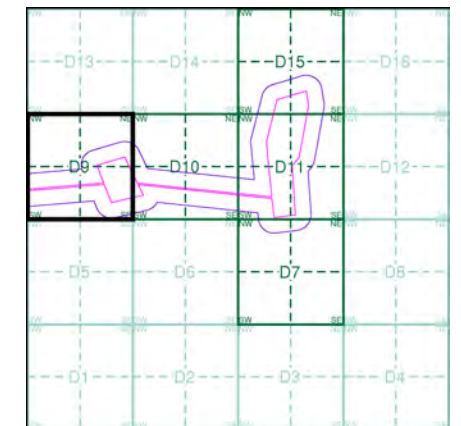

Order Details

Order Number: 297990273_1_1
 Customer Ref: 21-1088.04
 National Grid Reference: 492420, 385520
 Slice: D
 Site Area (Ha): 469.98
 Search Buffer (m): 100

Site Details

Cottam

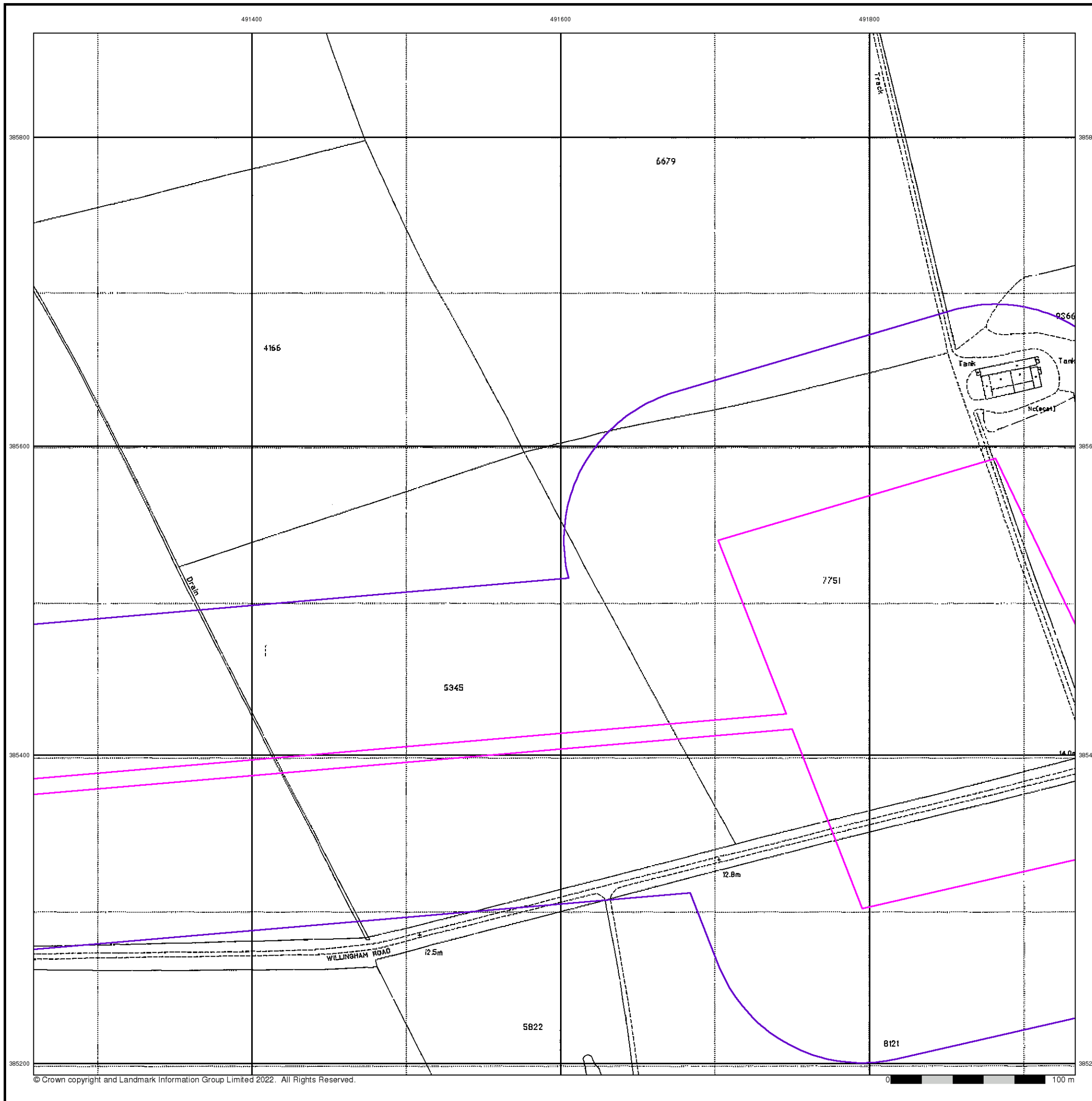

Historical Mapping Legends

Ordnance Survey County Series and Ordnance Survey Plan 1:2,500

Quarry **Gravel Pit** **Sand Pit**
Clay Pit **Shingle** **Refuse Heap**
Sloping Masonry **Flat Rock**
Marsh **Reeds** **Osiers**
Rough Pasture **Furze** **Wood**
Mixed Wood **Brushwood** **Orchard**
Fir **Ford** **Stepping Stones**
Ferry **Waterfall** **Lock**
Trig. Station **Altitude at Trig. Station**
B.M. 325.9 **Bench Mark** **Surface Level**
Arrow denotes flow of water **Antiquities (site of)**
Cutting **Embankment**
Railway crossing Road **Level Crossing** **Road crossing Railway**
Railway crossing River or Canal **Road over single stream** **Road over River or Canal**
County Boundary (Geographical)
County & Civil Parish Boundary
Administrative County & Civil Parish Boundary
County Borough Boundary (England)
County Burgh Boundary (Scotland)
Co. Boro. Bdy.
Co. Burgh Bdy.
BP BS Boundary Post or Stone **P.C.B** Police Call Box
B.R. Bridle Road **P** Pump
E.P Electricity Pylon **S.P** Signal Post
F.B. Foot Bridge **SL** Sluice
F.P. Foot Path **Sp.** Spring
G.P Guide Post or Board **T.C.B** Telephone Call Box
M.S Mile Stone **Tr.** Trough
M.P M.R Mooring Post or Ring **W** Well

Ordnance Survey Plan, Additional SIMs and Supply of Unpublished Survey Information 1:2,500 and 1:1,250

Inactive Quarry, Chalk Pit or Clay Pit **Active Quarry, Chalk Pit or Clay Pit**
Rock **Boulders**
Cliff **Slopes** **Top**
Roofed Building **Glazed Roof Building**
Sloping Masonry **Archway**
Non-Coniferous Tree (surveyed) **Coniferous Tree (surveyed)**
Non-Coniferous Trees (not surveyed) **Coniferous Trees (not surveyed)**
Orchard Tree **Scrub** **Bracken**
Coppice, Osier **Reeds** **Marsh, Saltings**
Rough Grassland **Heath** **Culvert**
Direction of water flow **Bench Mark** **Antiquity (site of)**
Cave Entrance **Triangulation Station** **Electricity Pylon**
Electricity Transmission Line
County Boundary (Geographical)
County & Civil Parish Boundary
Civil Parish Boundary
Admin. County or County Bor. Boundary
London Borough Boundary
Symbol marking point where boundary mereing changes
BH Beer House **P** Pillar, Pole or Post
BP, BS Boundary Post or Stone **PO** Post Office
Cn, C Capstan, Crane **PC** Public Convenience
Chy Chimney **PH** Public House
D Fn Drinking Fountain **Pp** Pump
EI P Electricity Pillar or Post **SB, S Br** Signal Box or Bridge
FAP Fire Alarm Pillar **SP, SL** Signal Post or Light
FB Foot Bridge **Spr** Spring
GP Guide Post **Tk** Tank or Track
H Hydrant or Hydraulic **TCB** Telephone Call Box
LC Level Crossing **TCP** Telephone Call Post
MH Manhole **Tr** Trough
MP Mile Post or Mooring Post **Wr Pt, Wr T** Water Point, Water Tap
MS Mile Stone **W** Well
NTL Normal Tidal Limit **Wd Pp** Wind Pump

Large-Scale National Grid Data 1:2,500 and 1:1,250

Cliff **Slopes** **Top**
Rock **Rock (scattered)**
Boulders **Boulders (scattered)**
Positioned Boulder **Scree**
Non-Coniferous Tree (surveyed) **Coniferous Tree (surveyed)**
Non-Coniferous Trees (not surveyed) **Coniferous Trees (not surveyed)**
Orchard Tree **Scrub** **Bracken**
Coppice, Osier **Reeds** **Marsh, Saltings**
Rough Grassland **Heath** **Culvert**
Direction of water flow **Triangulation Station** **Antiquity (site of)**
Electricity Transmission Line **Electricity Pylon**
B.M. 231.60m Bench Mark **Buildings with Building Seed**
Roofed Building **Glazed Roof Building**
Civil parish/community boundary
District boundary
County boundary
Boundary post/stone
Boundary mereing symbol (note: these always appear in opposed pairs or groups of three)
Bks Barracks **P** Pillar, Pole or Post
Bty Battery **PO** Post Office
Cemy Cemetery **PC** Public Convenience
Chy Chimney **Pp** Pump
Cis Cistern **Ppg Sta** Pumping Station
Dismtd Rly Dismantled Railway **PW** Place of Worship
EI Gen Sta Electricity Generating Station **Sewage Ppg Sta** Sewage Pumping Station
EI P Electricity Pole, Pillar **SB, S Br** Signal Box or Bridge
EI Sub Sta Electricity Sub Station **SP, SL** Signal Post or Light
FB Filter Bed **Spr** Spring
Fn / D Fn Fountain / Drinking Ftn. **Tk** Tank or Track
Gas Gov Gas Valve Compound **Tr** Trough
GVC Gas Governor **Wd Pp** Wind Pump
GP Guide Post **Wr Pt, Wr T** Water Point, Water Tap
MH Manhole **Wks** Works (building or area)
MP, MS Mile Post or Mile Stone **W** Well



Historical Mapping & Photography included:

Mapping Type	Scale	Date	Pg
Lincolnshire	1:2,500	1886	2
Lincolnshire	1:2,500	1906	3
Ordnance Survey Plan	1:2,500	1974	4
Large-Scale National Grid Data	1:2,500	1994	5

Historical Map - Segment D10

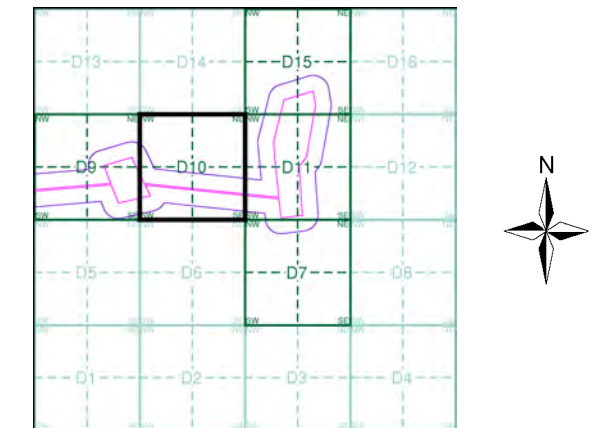

Order Details

Order Number: 297990273_1_1
 Customer Ref: 21-1088.04
 National Grid Reference: 492420, 385520
 Slice: D
 Site Area (Ha): 469.98
 Search Buffer (m): 100

Site Details

Cottam



Tel: [Redacted]
 Fax: [Redacted]
 Web: [Redacted]

Lincolnshire

Published 1886

Source map scale - 1:2,500

The historical maps shown were reproduced from maps predominantly held at the scale adopted for England, Wales and Scotland in the 1840's. In 1854 the 1:2,500 scale was adopted for mapping urban areas and by 1896 it covered the whole of what were considered to be the cultivated parts of Great Britain. The published date given below is often some years later than the surveyed date. Before 1938, all OS maps were based on the Cassini Projection, with independent surveys of a single county or group of counties, giving rise to significant inaccuracies in outlying areas.

Map Name(s) and Date(s)

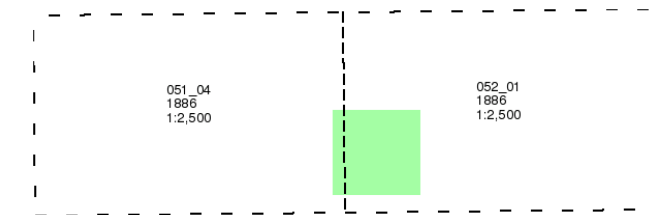

Historical Map - Segment D10

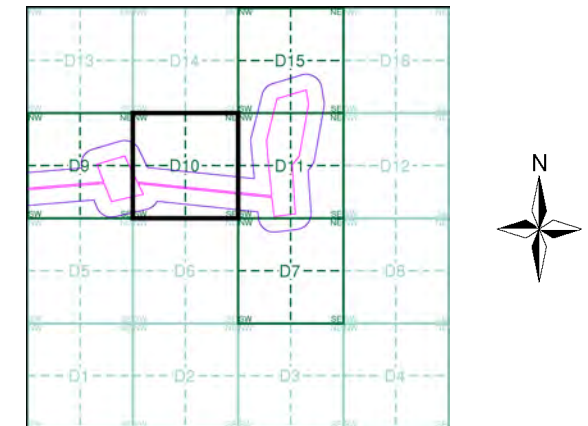

Order Details

Order Number: 297990273_1_1
 Customer Ref: 21-1088.04
 National Grid Reference: 492420, 385520
 Slice: D
 Site Area (Ha): 469.98
 Search Buffer (m): 100

Site Details

Cottam

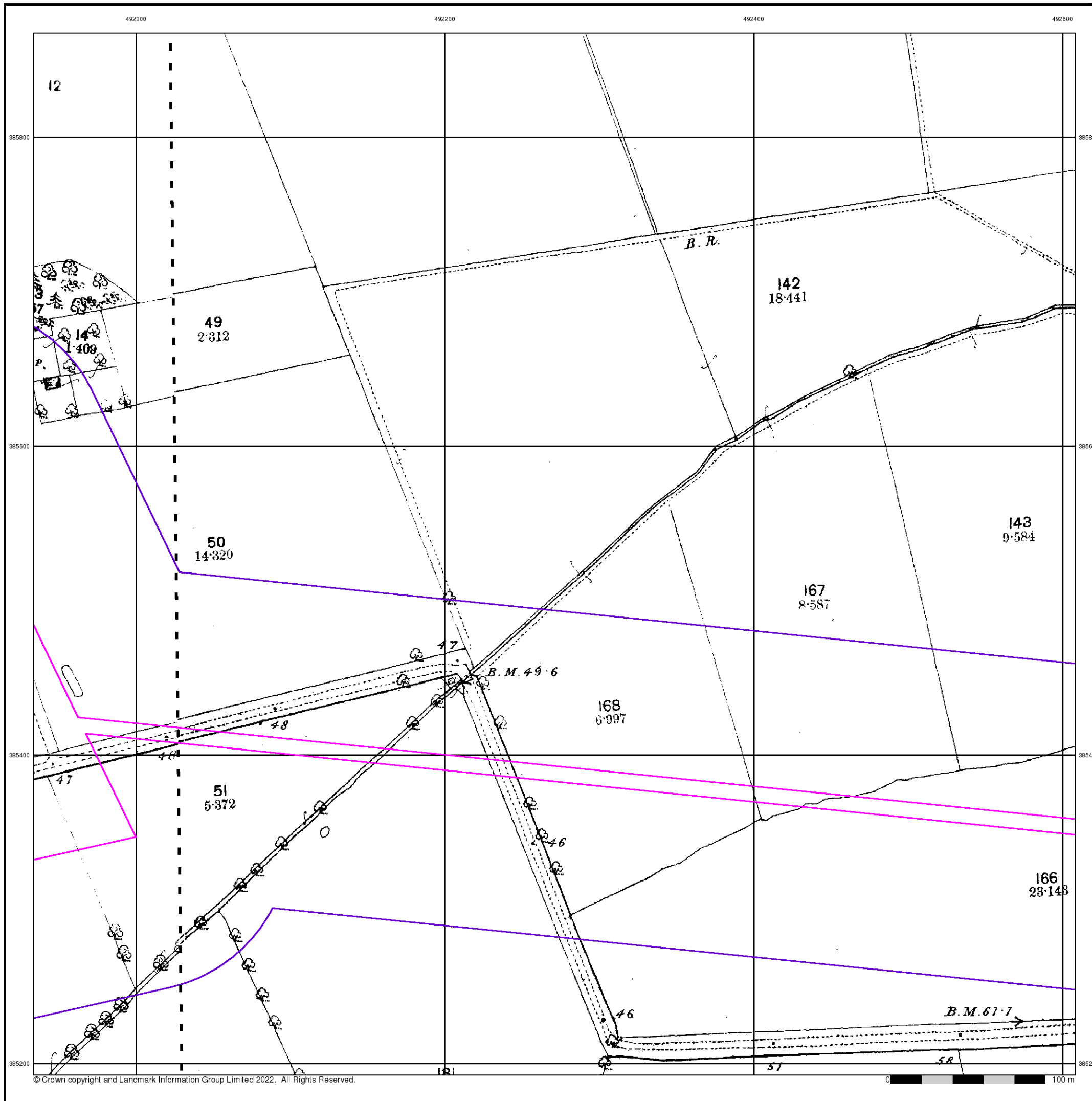

Lincolnshire

Published 1906

Source map scale - 1:2,500

The historical maps shown were reproduced from maps predominantly held at the scale adopted for England, Wales and Scotland in the 1840's. In 1854 the 1:2,500 scale was adopted for mapping urban areas and by 1896 it covered the whole of what were considered to be the cultivated parts of Great Britain. The published date given below is often some years later than the surveyed date. Before 1938, all OS maps were based on the Cassini Projection, with independent surveys of a single county or group of counties, giving rise to significant inaccuracies in outlying areas.

Map Name(s) and Date(s)

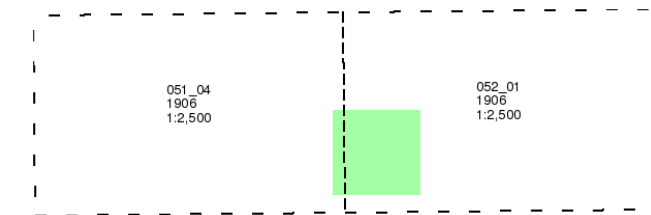

Historical Map - Segment D10

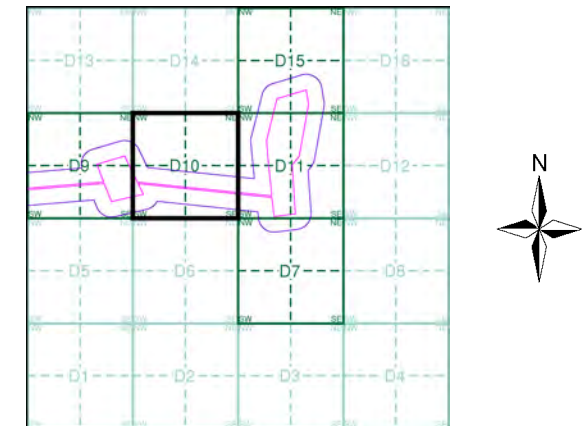

Order Details

Order Number: 297990273_1_1
 Customer Ref: 21-1088.04
 National Grid Reference: 492420, 385520
 Slice: D
 Site Area (Ha): 469.98
 Search Buffer (m): 100

Site Details

Cottam

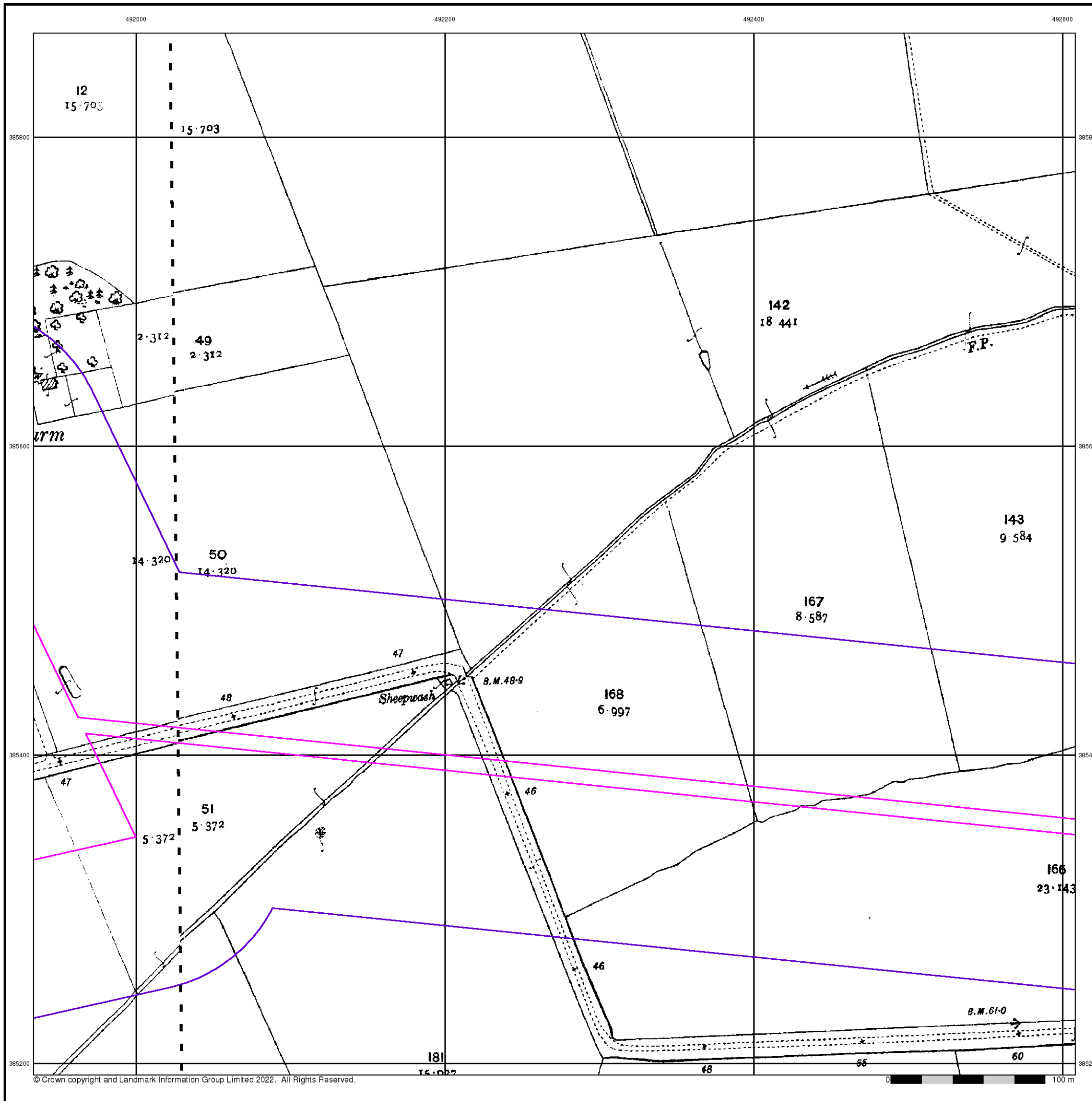

Ordnance Survey Plan

Published 1974

Source map scale - 1:2,500

The historical maps shown were reproduced from maps predominantly held at the scale adopted for England, Wales and Scotland in the 1840's. In 1854 the 1:2,500 scale was adopted for mapping urban areas and by 1896 it covered the whole of what were considered to be the cultivated parts of Great Britain. The published date given below is often some years later than the surveyed date. Before 1938, all OS maps were based on the Cassini Projection, with independent surveys of a single county or group of counties, giving rise to significant inaccuracies in outlying areas.

Map Name(s) and Date(s)

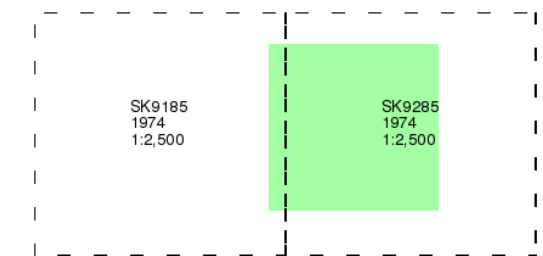

Historical Map - Segment D10

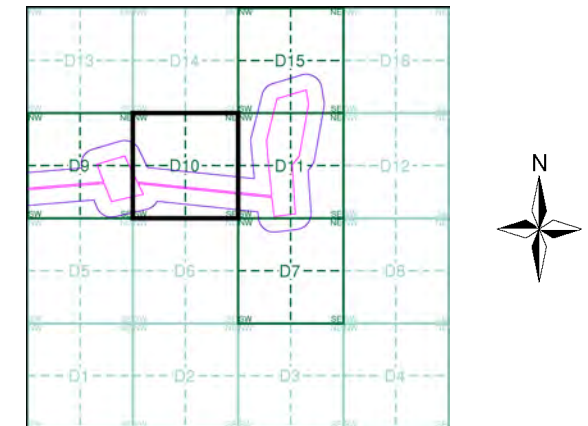

Order Details

Order Number: 297990273_1_1
 Customer Ref: 21-1088.04
 National Grid Reference: 492420, 385520
 Slice: D
 Site Area (Ha): 469.98
 Search Buffer (m): 100

Site Details

Cottam

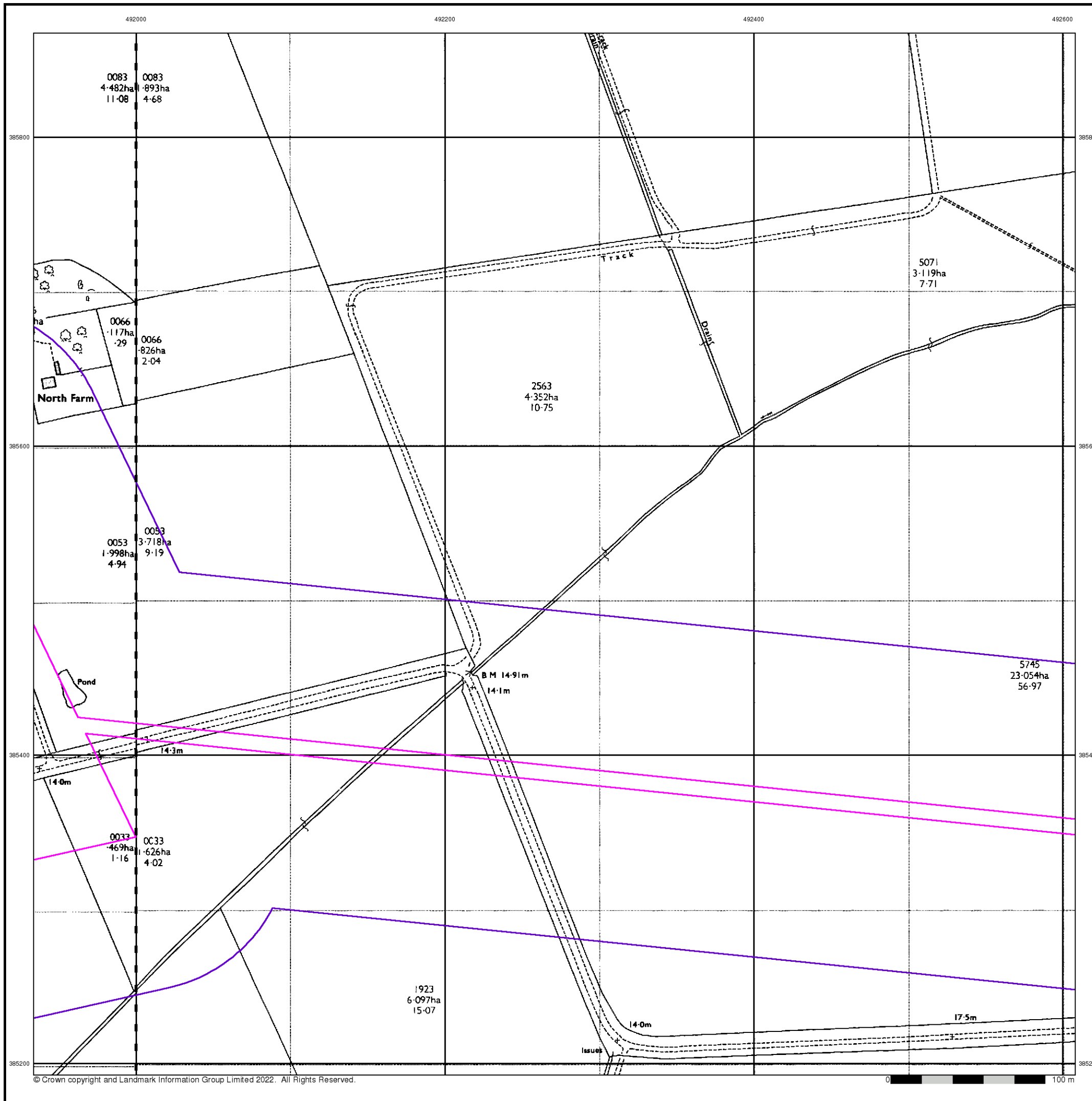

Large-Scale National Grid Data

Published 1994

Source map scale - 1:2,500

'Large Scale National Grid Data' superseded SIM cards (Ordnance Survey's 'Survey of Information on Microfilm') in 1992, and continued to be produced until 1999. These maps were the fore-runners of digital mapping and so provide detailed information on houses and roads, but tend to show less topographic features such as vegetation. These maps were produced at both 1:2,500 and 1:1,250 scales.

Map Name(s) and Date(s)

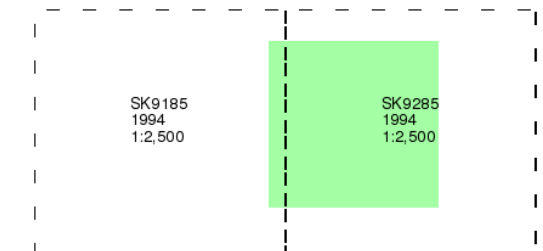

Historical Map - Segment D10

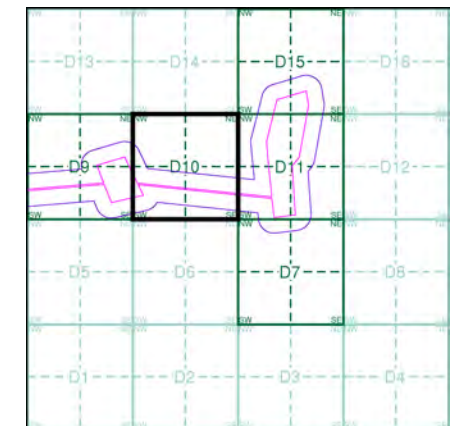

Order Details

Order Number: 297990273_1_1
 Customer Ref: 21-1088.04
 National Grid Reference: 492420, 385520
 Slice: D
 Site Area (Ha): 469.98
 Search Buffer (m): 100

Site Details

Cottam

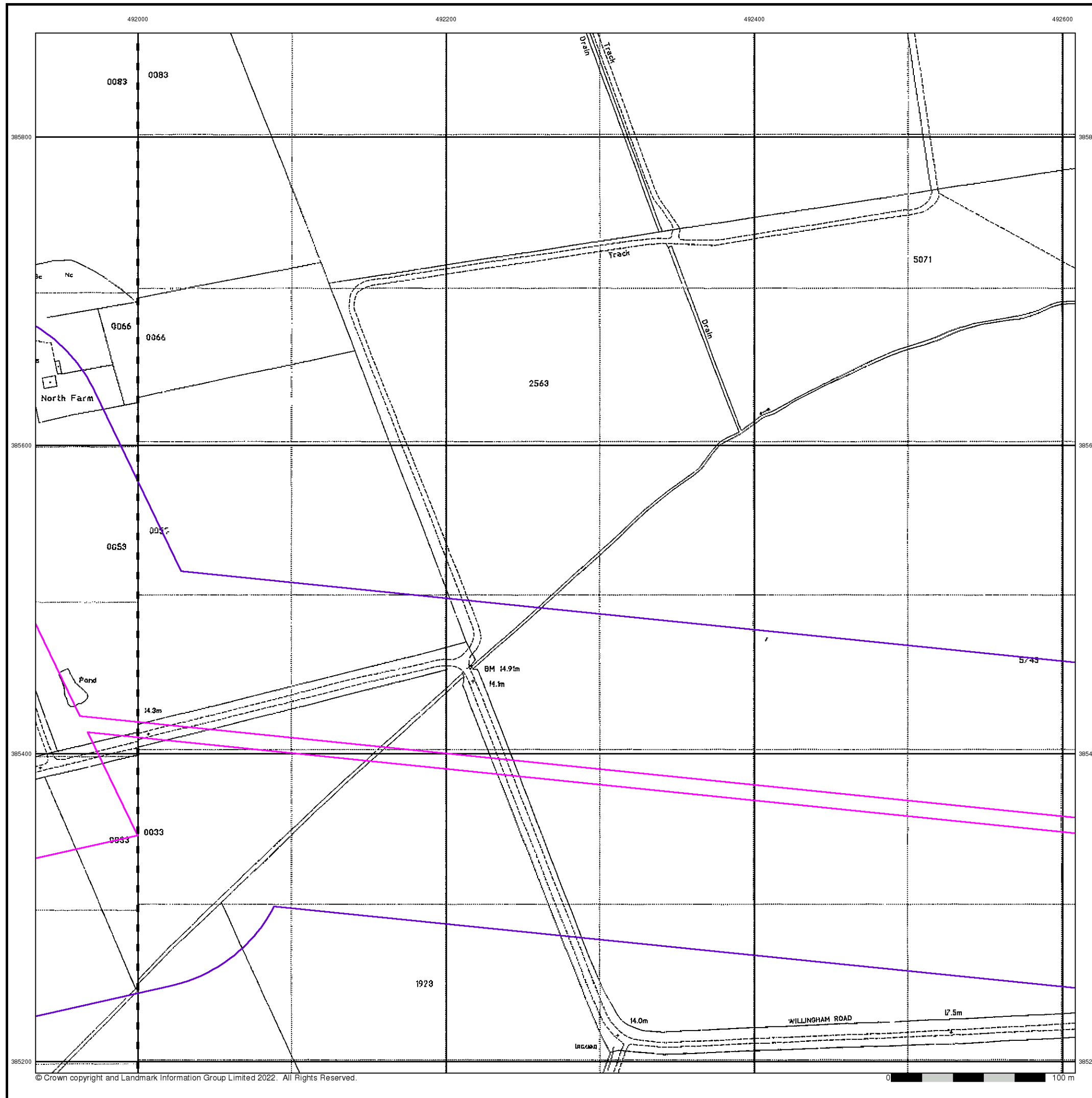

Historical Mapping Legends

Ordnance Survey County Series and Ordnance Survey Plan 1:2,500

Quarry **Gravel Pit** **Sand Pit**
Clay Pit **Shingle** **Refuse Heap**
Sloping Masonry **Flat Rock**
Marsh **Reeds** **Osiers**
Rough Pasture **Furze** **Wood**
Mixed Wood **Brushwood** **Orchard**
Fir **Ford** **Stepping Stones**
Ferry **Waterfall** **Lock**
Trig. Station **Altitude at Trig. Station**
B.M. 325.9 **Bench Mark** **Surface Level**
Arrow denotes flow of water **Antiquities (site of)**
Cutting **Embankment**
Railway crossing Road **Level Crossing** **Road crossing Railway**
Railway crossing River or Canal **Road over single stream** **Road over River or Canal**
County Boundary (Geographical)
County & Civil Parish Boundary
Administrative County & Civil Parish Boundary
County Borough Boundary (England)
Co. Boro. Bdy.
County Burgh Boundary (Scotland)
Co. Burgh Bdy.
BP BS Boundary Post or Stone **P.C.B** Police Call Box
B.R. Bridle Road **P** Pump
E.P Electricity Pylon **S.P** Signal Post
F.B. Foot Bridge **SL** Sluice
F.P. Foot Path **Sp.** Spring
G.P Guide Post or Board **T.C.B** Telephone Call Box
M.S Mile Stone **Tr.** Trough
M.P M.R Mooring Post or Ring **W** Well

Ordnance Survey Plan, Additional SIMs and Supply of Unpublished Survey Information 1:2,500 and 1:1,250

Inactive Quarry, Chalk Pit or Clay Pit **Active Quarry, Chalk Pit or Clay Pit**
Rock **Boulders**
Cliff **Slopes** **Top**
Roofed Building **Glazed Roof Building**
Sloping Masonry **Archway**
Non-Coniferous Tree (surveyed) **Coniferous Tree (surveyed)**
Non-Coniferous Trees (not surveyed) **Coniferous Trees (not surveyed)**
Orchard Tree **Scrub** **Bracken**
Coppice, Osier **Reeds** **Marsh, Saltings**
Rough Grassland **Heath** **Culvert**
Direction of water flow **Bench Mark** **Antiquity (site of)**
Cave Entrance **Triangulation Station** **Electricity Pylon**
Electricity Transmission Line
County Boundary (Geographical)
County & Civil Parish Boundary
Civil Parish Boundary
Admin. County or County Bor. Boundary
London Borough Boundary
Symbol marking point where boundary mereing changes
BH Beer House **P** Pillar, Pole or Post
BP, BS Boundary Post or Stone **PO** Post Office
Cn, C Capstan, Crane **PC** Public Convenience
Chy Chimney **PH** Public House
D Fn Drinking Fountain **Pp** Pump
EI P Electricity Pillar or Post **SB, S Br** Signal Box or Bridge
FAP Fire Alarm Pillar **SP, SL** Signal Post or Light
FB Foot Bridge **Spr** Spring
GP Guide Post **Tk** Tank or Track
H Hydrant or Hydraulic **TCB** Telephone Call Box
LC Level Crossing **TCP** Telephone Call Post
MH Manhole **Tr** Trough
MP Mile Post or Mooring Post **Wr Pt, Wr T** Water Point, Water Tap
MS Mile Stone **W** Well
NTL Normal Tidal Limit **Wd Pp** Wind Pump

Large-Scale National Grid Data 1:2,500 and 1:1,250

Cliff **Slopes** **Top**
Rock **Rock (scattered)**
Boulders **Boulders (scattered)**
Positioned Boulder **Scree**
Non-Coniferous Tree (surveyed) **Coniferous Tree (surveyed)**
Non-Coniferous Trees (not surveyed) **Coniferous Trees (not surveyed)**
Orchard Tree **Scrub** **Bracken**
Coppice, Osier **Reeds** **Marsh, Saltings**
Rough Grassland **Heath** **Culvert**
Direction of water flow **Triangulation Station** **Antiquity (site of)**
Electricity Transmission Line **Electricity Pylon**
B.M. 231.60m Bench Mark **Buildings with Building Seed**
Roofed Building **Glazed Roof Building**
Civil parish/community boundary
District boundary
County boundary
Boundary post/stone
Boundary mereing symbol (note: these always appear in opposed pairs or groups of three)
Bks Barracks **P** Pillar, Pole or Post
Bty Battery **PO** Post Office
Cemy Cemetery **PC** Public Convenience
Chy Chimney **Pp** Pump
Cis Cistern **Ppg Sta** Pumping Station
Dismtd Rly Dismantled Railway **PW** Place of Worship
EI Gen Sta Electricity Generating Station **Sewage Ppg Sta** Sewage Pumping Station
EI P Electricity Pole, Pillar **SB, S Br** Signal Box or Bridge
EI Sub Sta Electricity Sub Station **SP, SL** Signal Post or Light
FB Filter Bed **Spr** Spring
Fn / D Fn Fountain / Drinking Ftn. **Tk** Tank or Track
Gas Gov Gas Valve Compound **Tr** Trough
GVC Gas Governor **Wd Pp** Wind Pump
GP Guide Post **Wr Pt, Wr T** Water Point, Water Tap
MH Manhole **Wks** Works (building or area)
MP, MS Mile Post or Mile Stone **W** Well



Historical Mapping & Photography included:

Mapping Type	Scale	Date	Pg
Lincolnshire	1:2,500	1886	2
Lincolnshire	1:2,500	1906	3
Ordnance Survey Plan	1:2,500	1974	4
Large-Scale National Grid Data	1:2,500	1994	5

Historical Map - Segment D11

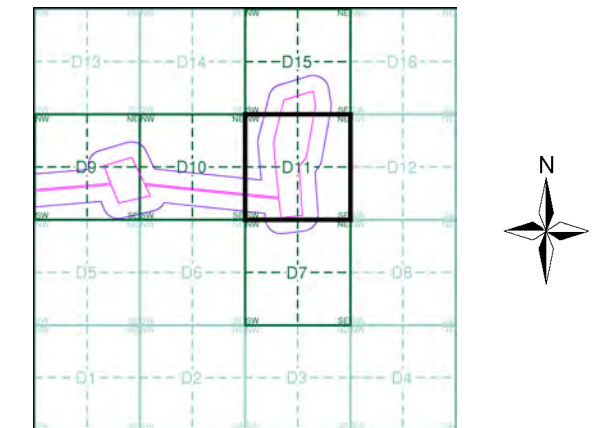

Order Details

Order Number: 297990273_1_1
 Customer Ref: 21-1088.04
 National Grid Reference: 492420, 385520
 Slice: D
 Site Area (Ha): 469.98
 Search Buffer (m): 100

Site Details

Cottam



Tel:
Fax:
Web:

Lincolnshire

Published 1886

Source map scale - 1:2,500

The historical maps shown were reproduced from maps predominantly held at the scale adopted for England, Wales and Scotland in the 1840's. In 1854 the 1:2,500 scale was adopted for mapping urban areas and by 1896 it covered the whole of what were considered to be the cultivated parts of Great Britain. The published date given below is often some years later than the surveyed date. Before 1938, all OS maps were based on the Cassini Projection, with independent surveys of a single county or group of counties, giving rise to significant inaccuracies in outlying areas.

Map Name(s) and Date(s)

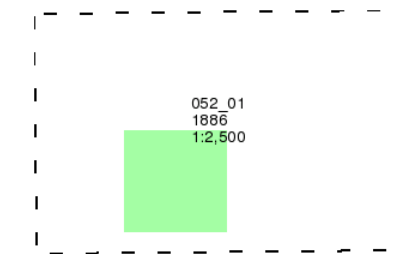

Historical Map - Segment D11

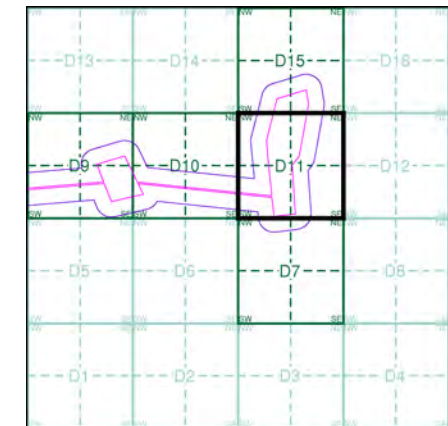

Order Details

Order Number: 297990273_1_1
 Customer Ref: 21-1088.04
 National Grid Reference: 492420, 385520
 Slice: D
 Site Area (Ha): 469.98
 Search Buffer (m): 100

Site Details

Cottam

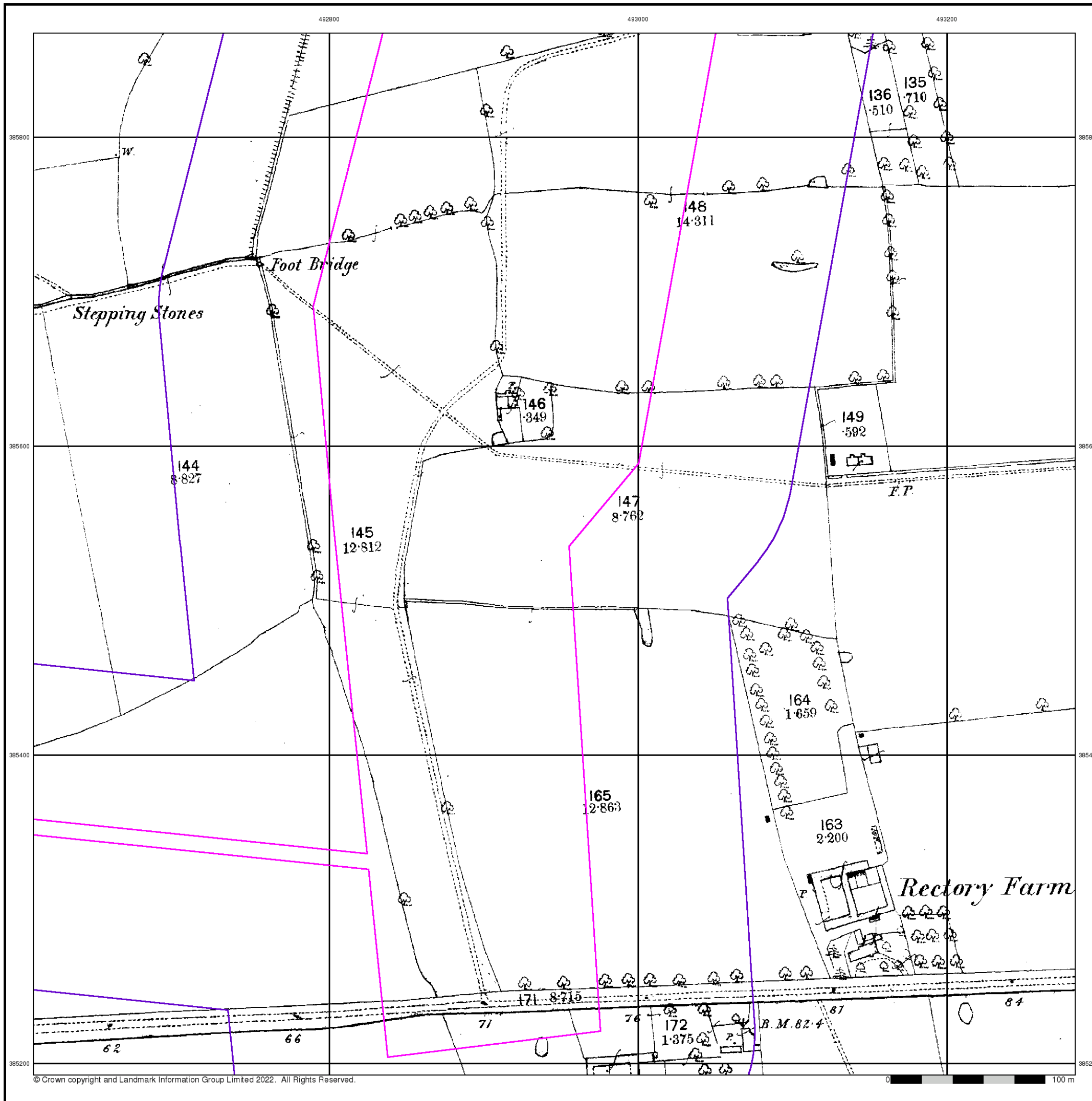

Lincolnshire

Published 1906

Source map scale - 1:2,500

The historical maps shown were reproduced from maps predominantly held at the scale adopted for England, Wales and Scotland in the 1840's. In 1854 the 1:2,500 scale was adopted for mapping urban areas and by 1896 it covered the whole of what were considered to be the cultivated parts of Great Britain. The published date given below is often some years later than the surveyed date. Before 1938, all OS maps were based on the Cassini Projection, with independent surveys of a single county or group of counties, giving rise to significant inaccuracies in outlying areas.

Map Name(s) and Date(s)

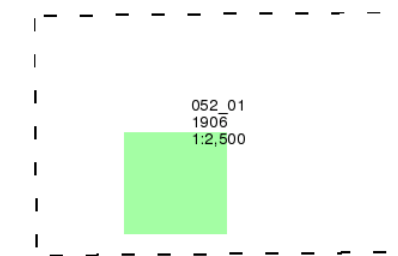

Historical Map - Segment D11

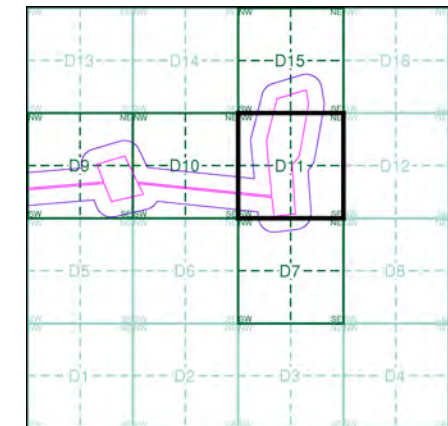

Order Details

Order Number: 297990273_1_1
 Customer Ref: 21-1088.04
 National Grid Reference: 492420, 385520
 Slice: D
 Site Area (Ha): 469.98
 Search Buffer (m): 100

Site Details

Cottam

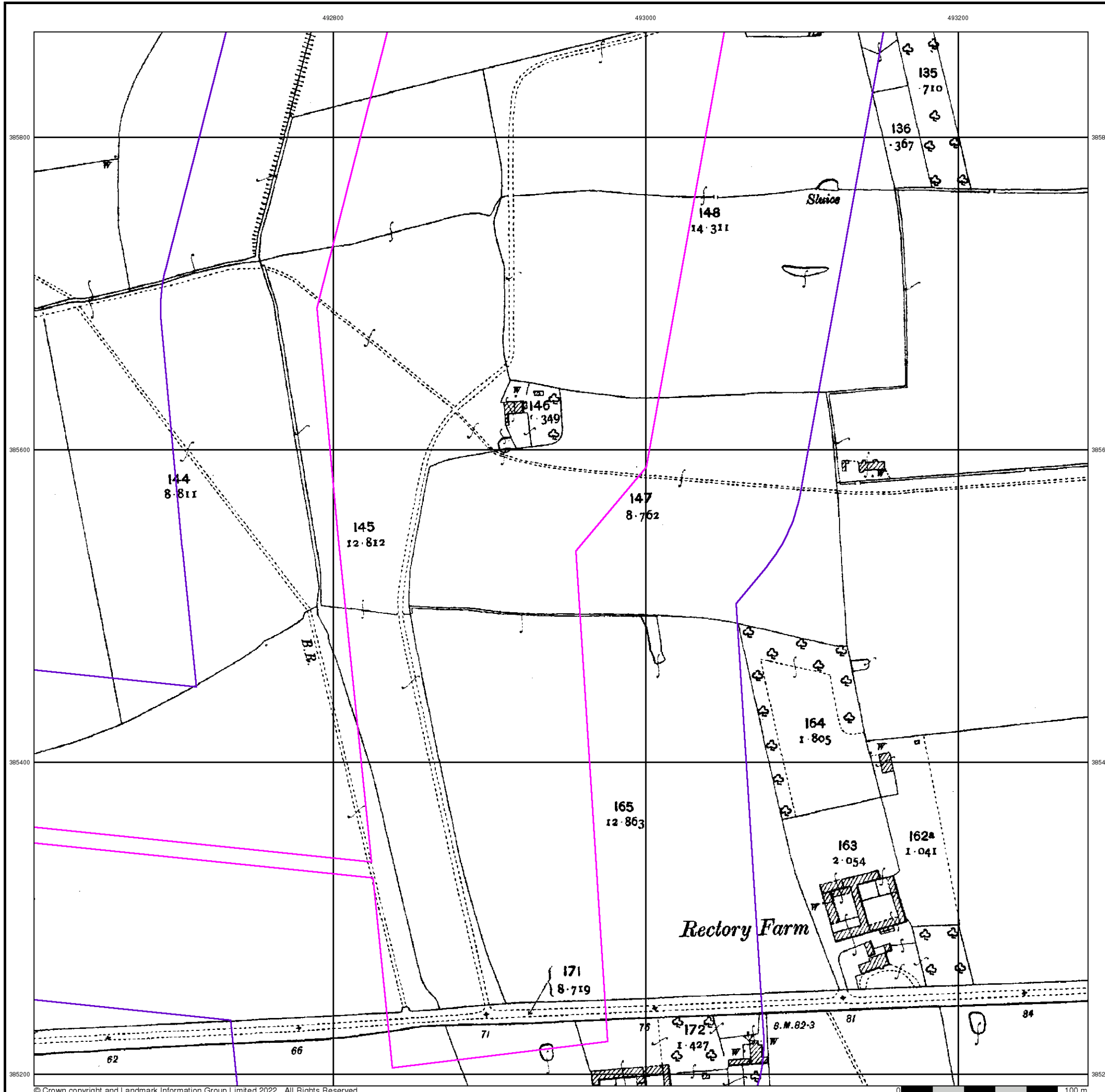

Ordnance Survey Plan

Published 1974

Source map scale - 1:2,500

The historical maps shown were reproduced from maps predominantly held at the scale adopted for England, Wales and Scotland in the 1840's. In 1854 the 1:2,500 scale was adopted for mapping urban areas and by 1896 it covered the whole of what were considered to be the cultivated parts of Great Britain. The published date given below is often some years later than the surveyed date. Before 1938, all OS maps were based on the Cassini Projection, with independent surveys of a single county or group of counties, giving rise to significant inaccuracies in outlying areas.

Map Name(s) and Date(s)

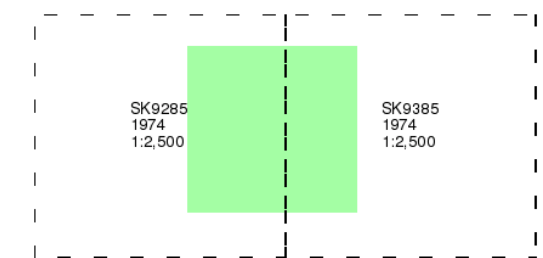

Historical Map - Segment D11

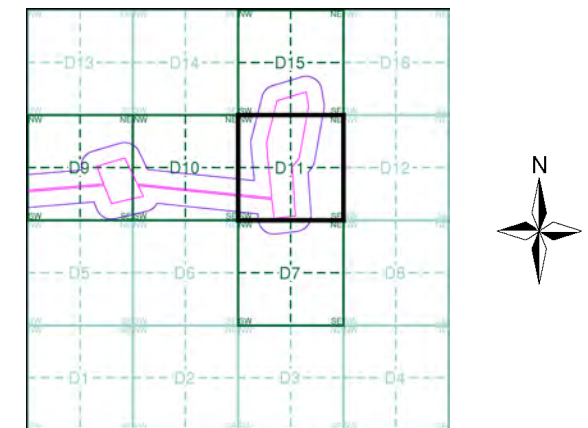

Order Details

Order Number: 297990273_1_1
 Customer Ref: 21-1088.04
 National Grid Reference: 492420, 385520
 Slice: D
 Site Area (Ha): 469.98
 Search Buffer (m): 100

Site Details

Cottam

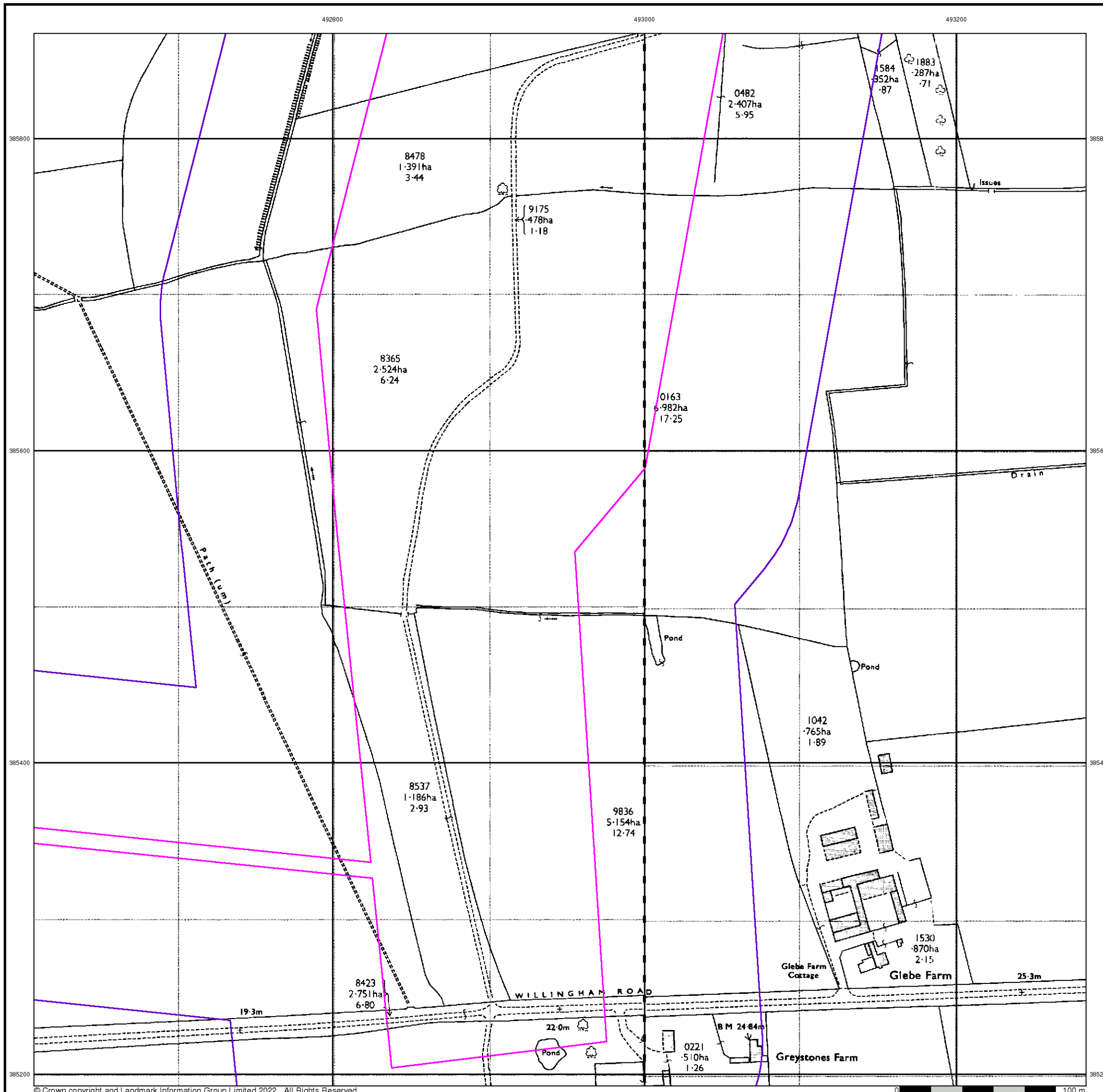

Large-Scale National Grid Data

Published 1994

Source map scale - 1:2,500

'Large Scale National Grid Data' superseded SIM cards (Ordnance Survey's 'Survey of Information on Microfilm') in 1992, and continued to be produced until 1999. These maps were the fore-runners of digital mapping and so provide detailed information on houses and roads, but tend to show less topographic features such as vegetation. These maps were produced at both 1:2,500 and 1:1,250 scales.

Map Name(s) and Date(s)

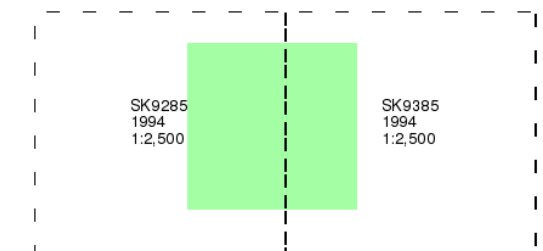

Historical Map - Segment D11

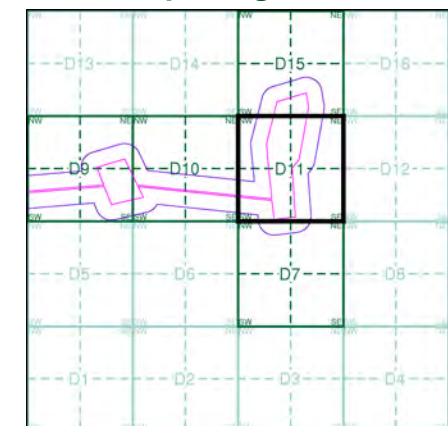

Order Details

Order Number: 297990273_1_1
 Customer Ref: 21-1088.04
 National Grid Reference: 492420, 385520
 Slice: D
 Site Area (Ha): 469.98
 Search Buffer (m): 100

Site Details

Cottam



Historical Mapping Legends

Ordnance Survey County Series and Ordnance Survey Plan 1:2,500

Quarry **Gravel Pit** **Sand Pit**
Clay Pit **Shingle** **Refuse Heap**
Sloping Masonry **Flat Rock**
Marsh **Reeds** **Osiers**
Rough Pasture **Furze** **Wood**
Mixed Wood **Brushwood** **Orchard**
Fir **Ford** **Stepping Stones**
Ferry **Waterfall** **Lock**
Trig. Station 507 **Altitude at Trig. Station**
B.M. 325.9 **Bench Mark** 342 **Surface Level**
Arrow denotes flow of water **Antiquities (site of)**
Cutting **Embankment**
Railway crossing Road **Level Crossing** **Road crossing Railway**
Railway crossing River or Canal **Road over single stream** **Road over River or Canal**
County Boundary (Geographical)
County & Civil Parish Boundary
Administrative County & Civil Parish Boundary
County Borough Boundary (England)
Co. Boro. Bdy.
County Burgh Boundary (Scotland)
BP BS **Boundary Post or Stone** **P.C.B** **Police Call Box**
B.R. **Bridle Road** **P** **Pump**
E.P **Electricity Pylon** **S.P** **Signal Post**
F.B. **Foot Bridge** **SL** **Sluice**
F.P. **Foot Path** **Sp.** **Spring**
G.P **Guide Post or Board** **T.C.B** **Telephone Call Box**
M.S **Mile Stone** **Tr.** **Trough**
M.P M.R **Mooring Post or Ring** **W** **Well**

Ordnance Survey Plan, Additional SIMs and Supply of Unpublished Survey Information 1:2,500 and 1:1,250

Inactive Quarry, Chalk Pit or Clay Pit **Active Quarry, Chalk Pit or Clay Pit**
Rock **Boulders**
Cliff **Slopes** **Top**
Roofed Building **Glazed Roof Building**
Sloping Masonry **Archway**
Non-Coniferous Tree (surveyed) **Coniferous Tree (surveyed)**
Non-Coniferous Trees (not surveyed) **Coniferous Trees (not surveyed)**
Orchard Tree **Scrub** **Bracken**
Coppice, Osier **Reeds** **Marsh, Saltings**
Rough Grassland **Heath** **Culvert**
Direction of water flow **Bench Mark** **Antiquity (site of)**
Cave Entrance **Triangulation Station** **Electricity Pylon**
Electricity Transmission Line
County Boundary (Geographical)
County & Civil Parish Boundary
Civil Parish Boundary
Admin. County or County Bor. Boundary
London Borough Boundary
Symbol marking point where boundary mereing changes
BH **Beer House** **P** **Pillar, Pole or Post**
BP, BS **Boundary Post or Stone** **PO** **Post Office**
Cn, C **Capstan, Crane** **PC** **Public Convenience**
Chy **Chimney** **PH** **Public House**
D Fn **Drinking Fountain** **Pp** **Pump**
EI P **Electricity Pillar or Post** **SB, S Br** **Signal Box or Bridge**
FAP **Fire Alarm Pillar** **SP, SL** **Signal Post or Light**
FB **Foot Bridge** **Spr** **Spring**
GP **Guide Post** **Tk** **Tank or Track**
H **Hydrant or Hydraulic** **TCB** **Telephone Call Box**
LC **Level Crossing** **TCP** **Telephone Call Post**
MH **Manhole** **Tr** **Trough**
MP **Mile Post or Mooring Post** **Wr Pt, Wr T** **Water Point, Water Tap**
MS **Mile Stone** **W** **Well**
NTL **Normal Tidal Limit** **Wd Pp** **Wind Pump**

Large-Scale National Grid Data 1:2,500 and 1:1,250

Cliff **Slopes** **Top**
Rock **Rock (scattered)**
Boulders **Boulders (scattered)**
Positioned Boulder **Scree**
Non-Coniferous Tree (surveyed) **Coniferous Tree (surveyed)**
Non-Coniferous Trees (not surveyed) **Coniferous Trees (not surveyed)**
Orchard Tree **Scrub** **Bracken**
Coppice, Osier **Reeds** **Marsh, Saltings**
Rough Grassland **Heath** **Culvert**
Direction of water flow **Triangulation Station** **Antiquity (site of)**
Electricity Transmission Line **Electricity Pylon**
B.M. 231.60m **Bench Mark** **Buildings with Building Seed**
Roofed Building **Glazed Roof Building**
Civil parish/community boundary
District boundary
County boundary
Boundary post/stone
Boundary mereing symbol (note: these always appear in opposed pairs or groups of three)
Bks **Barracks** **P** **Pillar, Pole or Post**
Bty **Battery** **PO** **Post Office**
Cemy **Cemetery** **PC** **Public Convenience**
Chy **Chimney** **Pp** **Pump**
Cis **Cistern** **Ppg Sta** **Pumping Station**
Dismtd Rly **Dismantled Railway** **PW** **Place of Worship**
EI Gen Sta **Electricity Generating Station** **Sewage Ppg Sta** **Sewage Pumping Station**
EI P **Electricity Pole, Pillar** **SB, S Br** **Signal Box or Bridge**
EI Sub Sta **Electricity Sub Station** **SP, SL** **Signal Post or Light**
FB **Filter Bed** **Spr** **Spring**
Fn / D Fn **Fountain / Drinking Ftn.** **Tk** **Tank or Track**
Gas Gov **Gas Valve Compound** **Tr** **Trough**
GVC **Gas Governor** **Wd Pp** **Wind Pump**
GP **Guide Post** **Wr Pt, Wr T** **Water Point, Water Tap**
MH **Manhole** **Wks** **Works (building or area)**
MP, MS **Mile Post or Mile Stone** **W** **Well**



Historical Mapping & Photography included:

Mapping Type	Scale	Date	Pg
Lincolnshire	1:2,500	1886	2
Lincolnshire	1:2,500	1906	3
Ordnance Survey Plan	1:2,500	1974	4
Large-Scale National Grid Data	1:2,500	1994	5

Historical Map - Segment D15

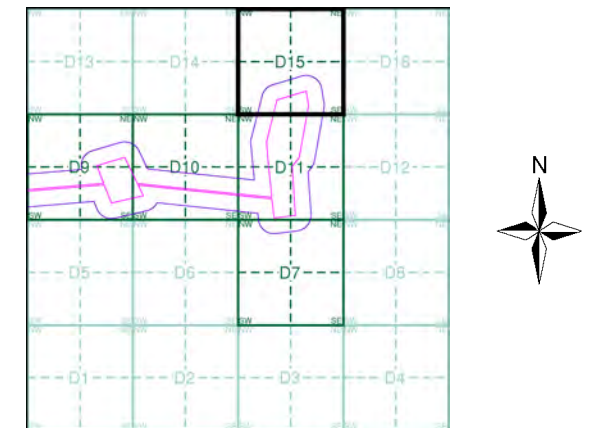

Order Details

Order Number: 297990273_1_1
 Customer Ref: 21-1088.04
 National Grid Reference: 492420, 385520
 Slice: D
 Site Area (Ha): 469.98
 Search Buffer (m): 100

Site Details

Cottam



Tel: [Redacted]
 Fax: [Redacted]
 Web: [Redacted]

Lincolnshire
Published 1886

Source map scale - 1:2,500

The historical maps shown were reproduced from maps predominantly held at the scale adopted for England, Wales and Scotland in the 1840's. In 1854 the 1:2,500 scale was adopted for mapping urban areas and by 1896 it covered the whole of what were considered to be the cultivated parts of Great Britain. The published date given below is often some years later than the surveyed date. Before 1938, all OS maps were based on the Cassini Projection, with independent surveys of a single county or group of counties, giving rise to significant inaccuracies in outlying areas.

Map Name(s) and Date(s)

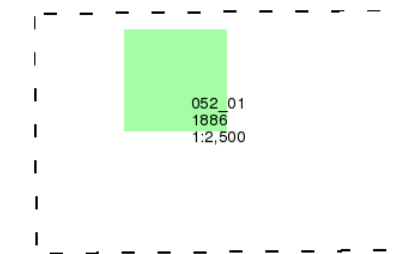

Historical Map - Segment D15

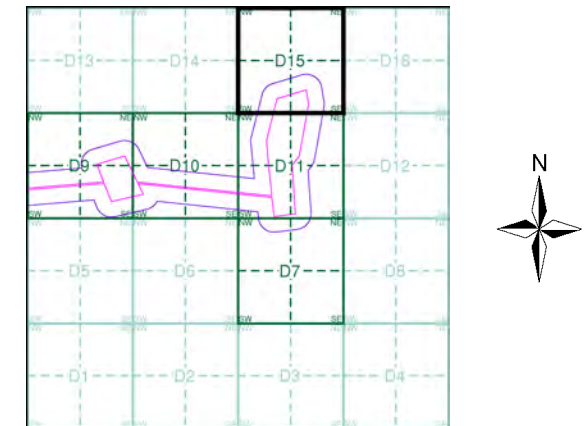

Order Details

Order Number: 297990273_1_1
 Customer Ref: 21-1088.04
 National Grid Reference: 492420, 385520
 Slice: D
 Site Area (Ha): 469.98
 Search Buffer (m): 100

Site Details

Cottam

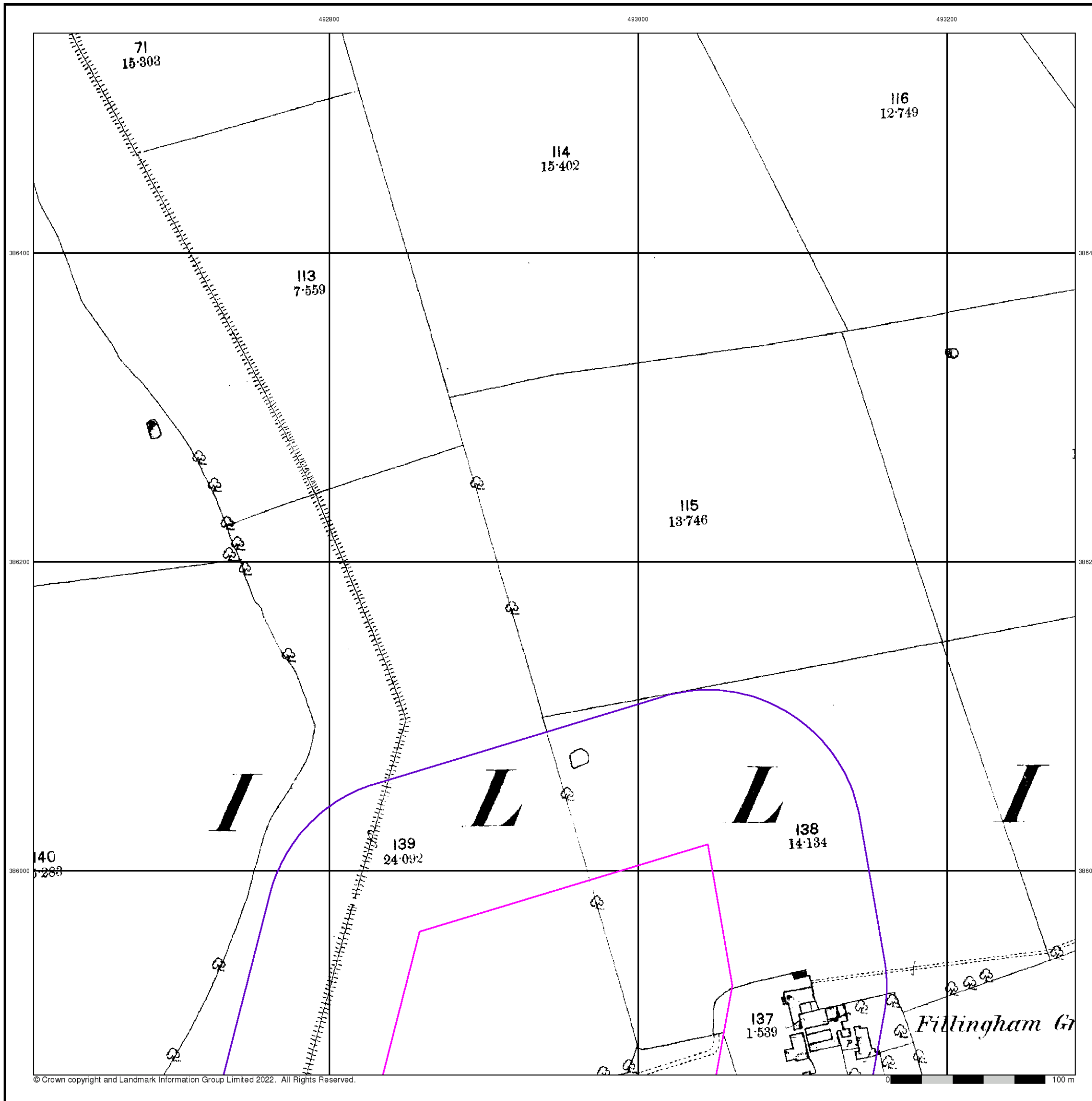

Lincolnshire
Published 1906

Source map scale - 1:2,500

The historical maps shown were reproduced from maps predominantly held at the scale adopted for England, Wales and Scotland in the 1840's. In 1854 the 1:2,500 scale was adopted for mapping urban areas and by 1896 it covered the whole of what were considered to be the cultivated parts of Great Britain. The published date given below is often some years later than the surveyed date. Before 1938, all OS maps were based on the Cassini Projection, with independent surveys of a single county or group of counties, giving rise to significant inaccuracies in outlying areas.

Map Name(s) and Date(s)

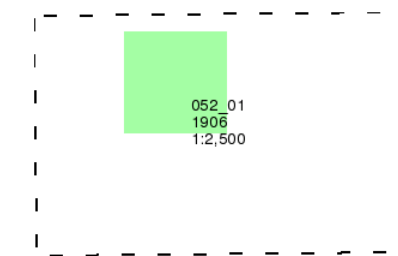

Historical Map - Segment D15

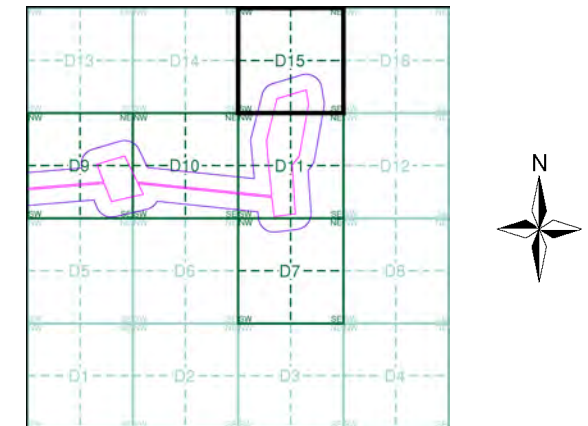

Order Details

Order Number: 297990273_1_1
 Customer Ref: 21-1088.04
 National Grid Reference: 492420, 385520
 Slice: D
 Site Area (Ha): 469.98
 Search Buffer (m): 100

Site Details

Cottam

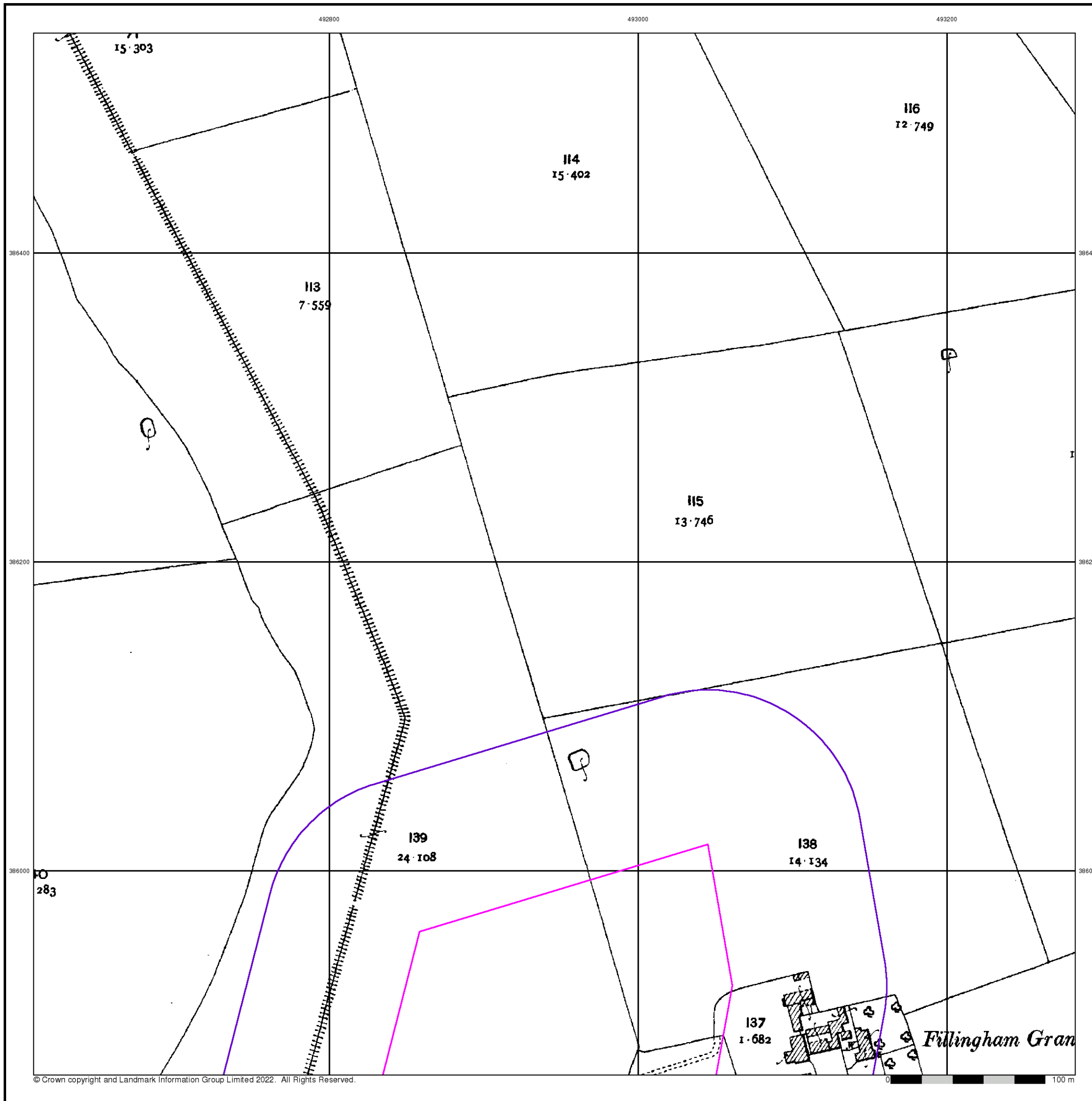

Ordnance Survey Plan

Published 1974

Source map scale - 1:2,500

The historical maps shown were reproduced from maps predominantly held at the scale adopted for England, Wales and Scotland in the 1840's. In 1854 the 1:2,500 scale was adopted for mapping urban areas and by 1896 it covered the whole of what were considered to be the cultivated parts of Great Britain. The published date given below is often some years later than the surveyed date. Before 1938, all OS maps were based on the Cassini Projection, with independent surveys of a single county or group of counties, giving rise to significant inaccuracies in outlying areas.

Map Name(s) and Date(s)

SK9286 1974 1:2,500	SK9386 1974 1:2,500
SK9285 1974 1:2,500	SK9385 1974 1:2,500

Historical Map - Segment D15

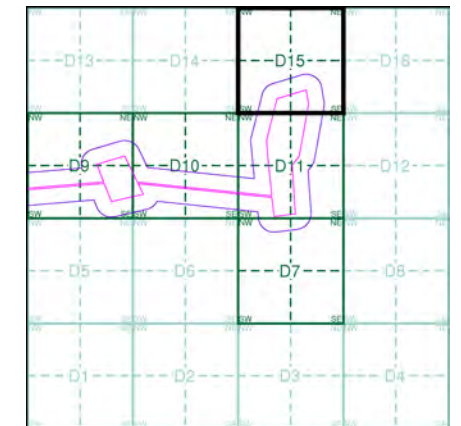

Order Details

Order Number: 297990273_1_1
 Customer Ref: 21-1088.04
 National Grid Reference: 492420, 385520
 Slice: D
 Site Area (Ha): 469.98
 Search Buffer (m): 100

Site Details

Cottam

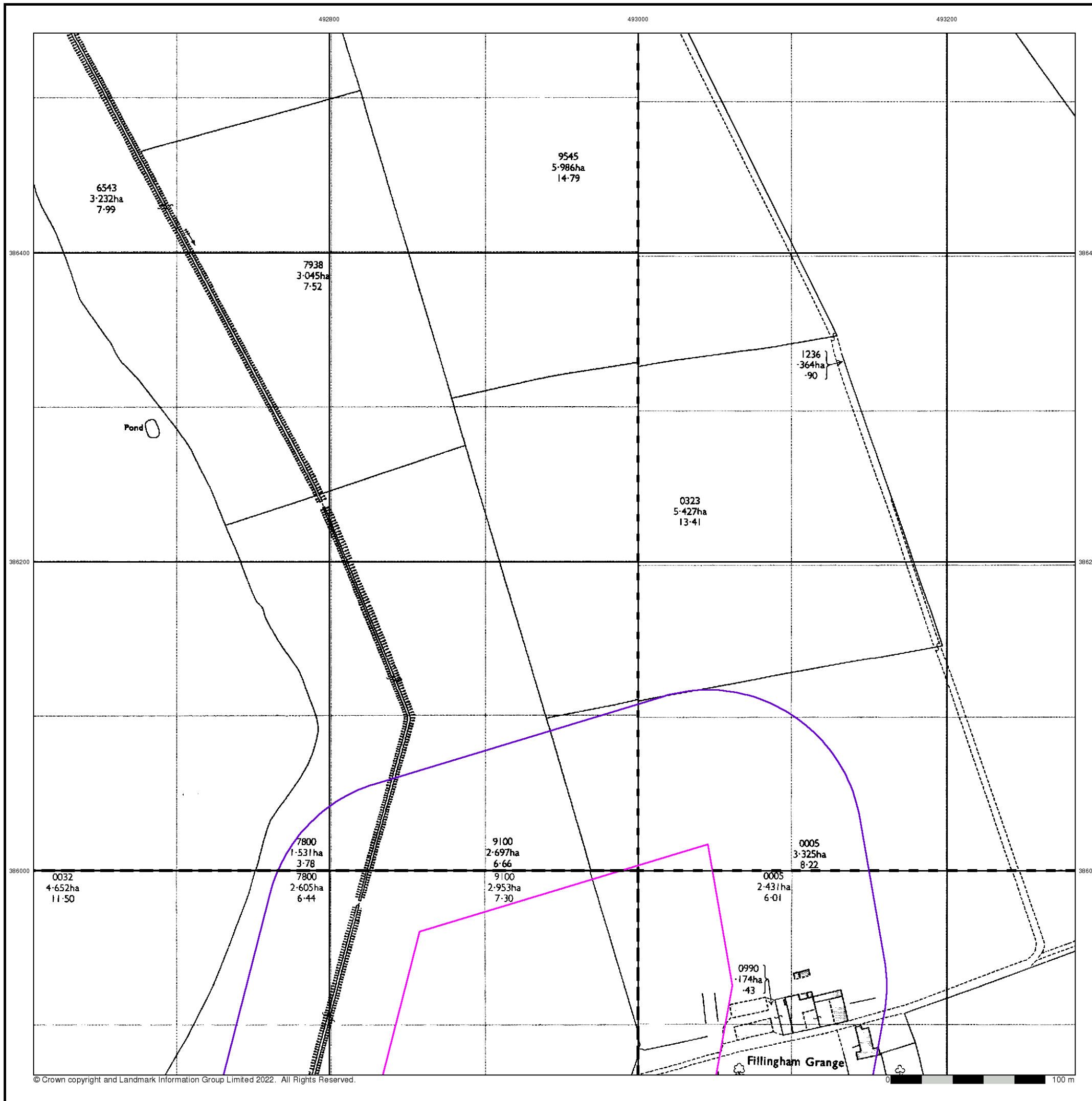

Large-Scale National Grid Data

Published 1994

Source map scale - 1:2,500

'Large Scale National Grid Data' superseded SIM cards (Ordnance Survey's 'Survey of Information on Microfilm') in 1992, and continued to be produced until 1999. These maps were the fore-runners of digital mapping and so provide detailed information on houses and roads, but tend to show less topographic features such as vegetation. These maps were produced at both 1:2,500 and 1:1,250 scales.

Map Name(s) and Date(s)

SK9286 1994 1:2,500	SK9386 1994 1:2,500
SK9285 1994 1:2,500	SK9385 1994 1:2,500

Historical Map - Segment D15

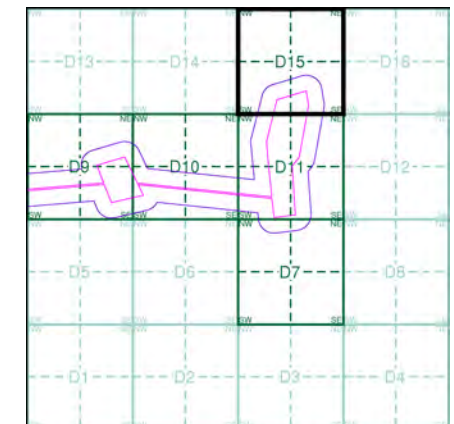

Order Details

Order Number: 297990273_1_1
 Customer Ref: 21-1088.04
 National Grid Reference: 492420, 385520
 Slice: D
 Site Area (Ha): 469.98
 Search Buffer (m): 100

Site Details

Cottam

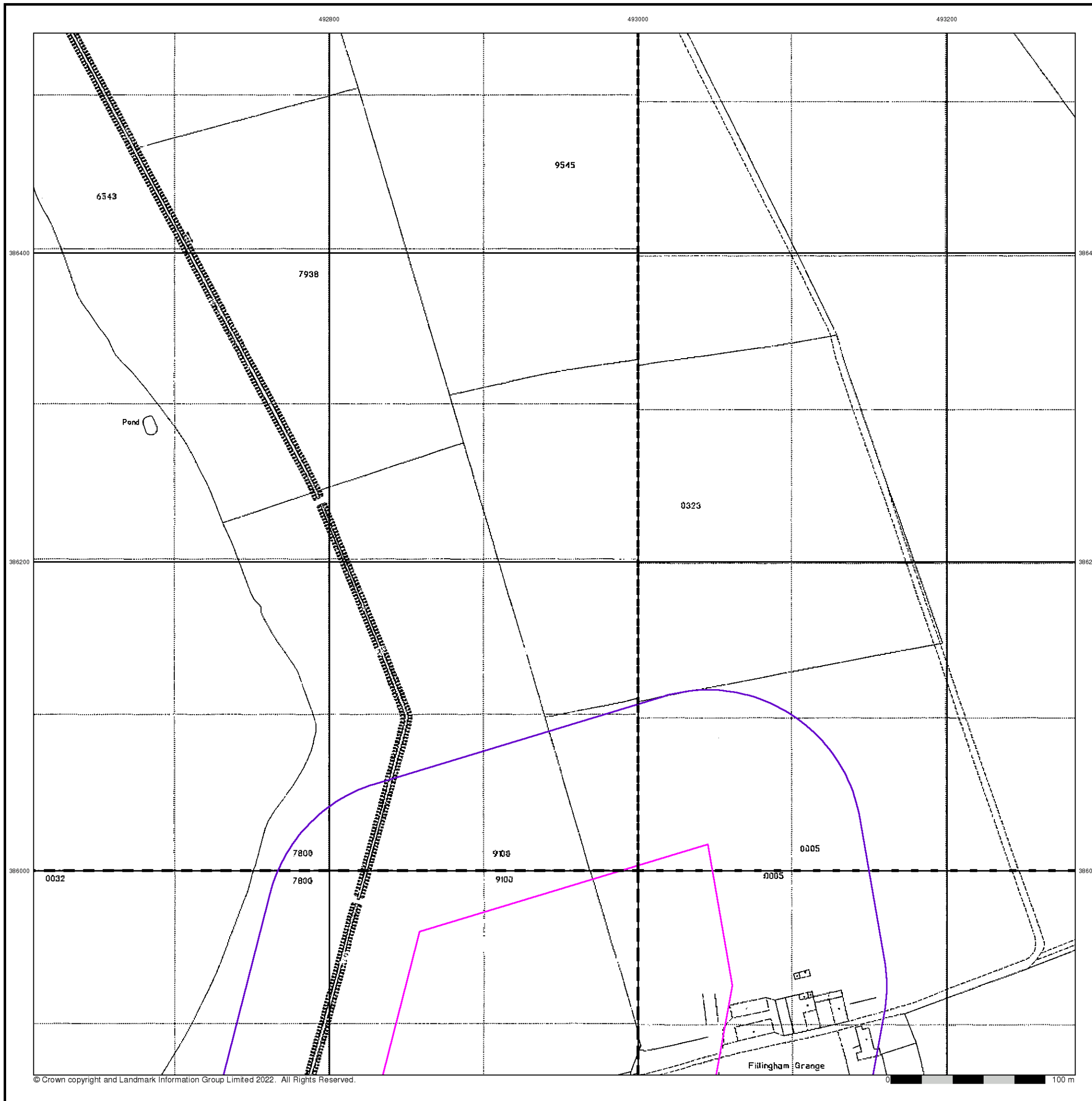

Historical Mapping Legends

Ordnance Survey County Series 1:10,560

- Gravel Pit
- Sand Pit
- Other Pits
- Quarry
- Shingle
- Orchard
- Osiers
- Reeds
- Marsh
- Mixed Wood
- Deciduous
- Brushwood
- Fir
- Furze
- Rough Pasture
- Arrow denotes flow of water
- Trigonometrical Station
- Site of Antiquities
- Bench Mark
- Pump, Guide Post, Signal Post
- Well, Spring, Boundary Post
- 285** Surface Level
- Sketched Contour
- Instrumental Contour
- Main Roads
- Minor Roads
- Sunken Road
- Raised Road
- Road over Railway
- Railway over River
- Railway over Road
- Level Crossing
- Road over River or Canal
- Road over Stream
- Road over Stream
- County Boundary (Geographical)
- County & Civil Parish Boundary
- Administrative County & Civil Parish Boundary
- County Borough Boundary (England)
- County Burgh Boundary (Scotland)
- Rural District Boundary
- Civil Parish Boundary

Ordnance Survey Plan 1:10,000

- Chalk Pit, Clay Pit or Quarry
- Gravel Pit
- Sand Pit
- Disused Pit or Quarry
- Refuse or Slag Heap
- Lake, Loch or Pond
- Dunes
- Boulders
- Coniferous Trees
- Non-Coniferous Trees
- Orchard
- Scrub
- Coppice
- Bracken
- Heath
- Rough Grassland
- Marsh
- Reeds
- Saltings
- Building
- Glasshouse
- Sloping Masonry
- Pylon
- Electricity Transmission Line
- Pole
- Cutting
- Embankment
- Standard Gauge Multiple Track
- Standard Gauge Single Track
- Siding, Tramway or Mineral Line
- Narrow Gauge
- Geographical County
- Administrative County, County Borough or County of City
- Municipal Borough, Urban or Rural District, Burgh or District Council
- Borough, Burgh or County Constituency
- Civil Parish
- BP, BS Boundary Post or Stone
- Ch Church
- CH Club House
- F E Sta Fire Engine Station
- FB Foot Bridge
- Fn Fountain
- GP Guide Post
- MP Mile Post
- MS Mile Stone
- Pol Sta Police Station
- PO Post Office
- PC Public Convenience
- PH Public House
- SB Signal Box
- Spr Spring
- TCB Telephone Call Box
- TCP Telephone Call Post
- W Well

1:10,000 Raster Mapping

- Gravel Pit
- Rock
- Boulders
- Shingle
- Sand
- Slopes
- General detail
- Overhead detail
- Multi-track railway
- County boundary (England only)
- District, Unitary, Metropolitan, London Borough boundary
- Area of wooded vegetation
- Non-coniferous trees (scattered)
- Coniferous trees (scattered)
- Orchard
- Rough Grassland
- Scrub
- Water feature
- MHW(S) Mean high water (springs)
- Bench mark (where shown)
- Point feature (e.g. Guide Post or Mile Stone)
- Site of (antiquity)
- General Building
- Refuse tip or slag heap
- Rock (scattered)
- Boulders (scattered)
- Mud
- Sand Pit
- Top of cliff
- Underground detail
- Narrow gauge railway
- Single track railway
- Civil, parish or community boundary
- Constituency boundary
- Non-coniferous trees
- Coniferous trees
- Positioned tree
- Coppice or Osiers
- Heath
- Marsh, Salt Marsh or Reeds
- Flow arrows
- MLW(S) Mean low water (springs)
- Triangulation station
- Pylon, flare stack or lighting tower
- Glasshouse
- Important Building



Historical Mapping & Photography included:

Mapping Type	Scale	Date	Pg
Lincolnshire	1:10,560	1885	2
Lincolnshire	1:10,560	1907	3
Lincolnshire	1:10,560	1907	4
Lincolnshire	1:10,560	1947	5
Ordnance Survey Plan	1:10,000	1956	6
Ordnance Survey Plan	1:10,000	1970 - 1979	7
Ordnance Survey Plan	1:10,000	1980	8
10K Raster Mapping	1:10,000	2000	9
Street View	Variable		10

Historical Map - Slice E

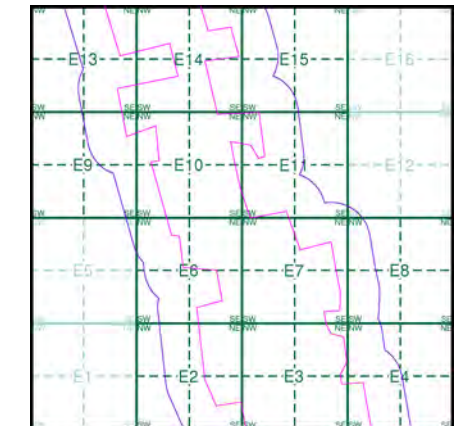

Order Details

Order Number: 297990273_1_1
 Customer Ref: 21-1088.04
 National Grid Reference: 489860, 387850
 Slice: E
 Site Area (Ha): 469.98
 Search Buffer (m): 250

Site Details

Cottam



Tel: [Redacted]
 Fax: [Redacted]
 Web: [Redacted]

Lincolnshire

Published 1885

Source map scale - 1:10,560

The historical maps shown were reproduced from maps predominantly held at the scale adopted for England, Wales and Scotland in the 1840's. In 1854 the 1:2,500 scale was adopted for mapping urban areas; these maps were used to update the 1:10,560 maps. The published date given therefore is often some years later than the surveyed date. Before 1938, all OS maps were based on the Cassini Projection, with independent surveys of a single county or group of counties, giving rise to significant inaccuracies in outlying areas. In the late 1940's, a Provisional Edition was produced, which updated the 1:10,560 mapping from a number of sources. The maps appear unfinished - with all military camps and other strategic sites removed. These maps were initially overprinted with the National Grid. In 1970, the first 1:10,000 maps were produced using the Transverse Mercator Projection. The revision process continued until recently, with new editions appearing every 10 years or so for urban areas.

Map Name(s) and Date(s)

043SE
1885
1:10,560
051NE
1885
1:10,560

Historical Map - Slice E

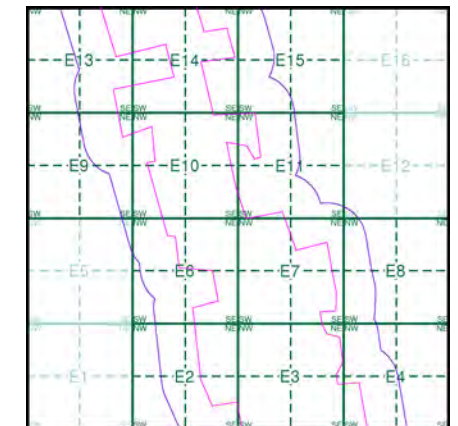

Order Details

Order Number: 297990273_1_1
 Customer Ref: 21-1088.04
 National Grid Reference: 489860, 387850
 Slice: E
 Site Area (Ha): 469.98
 Search Buffer (m): 250

Site Details

Cottam

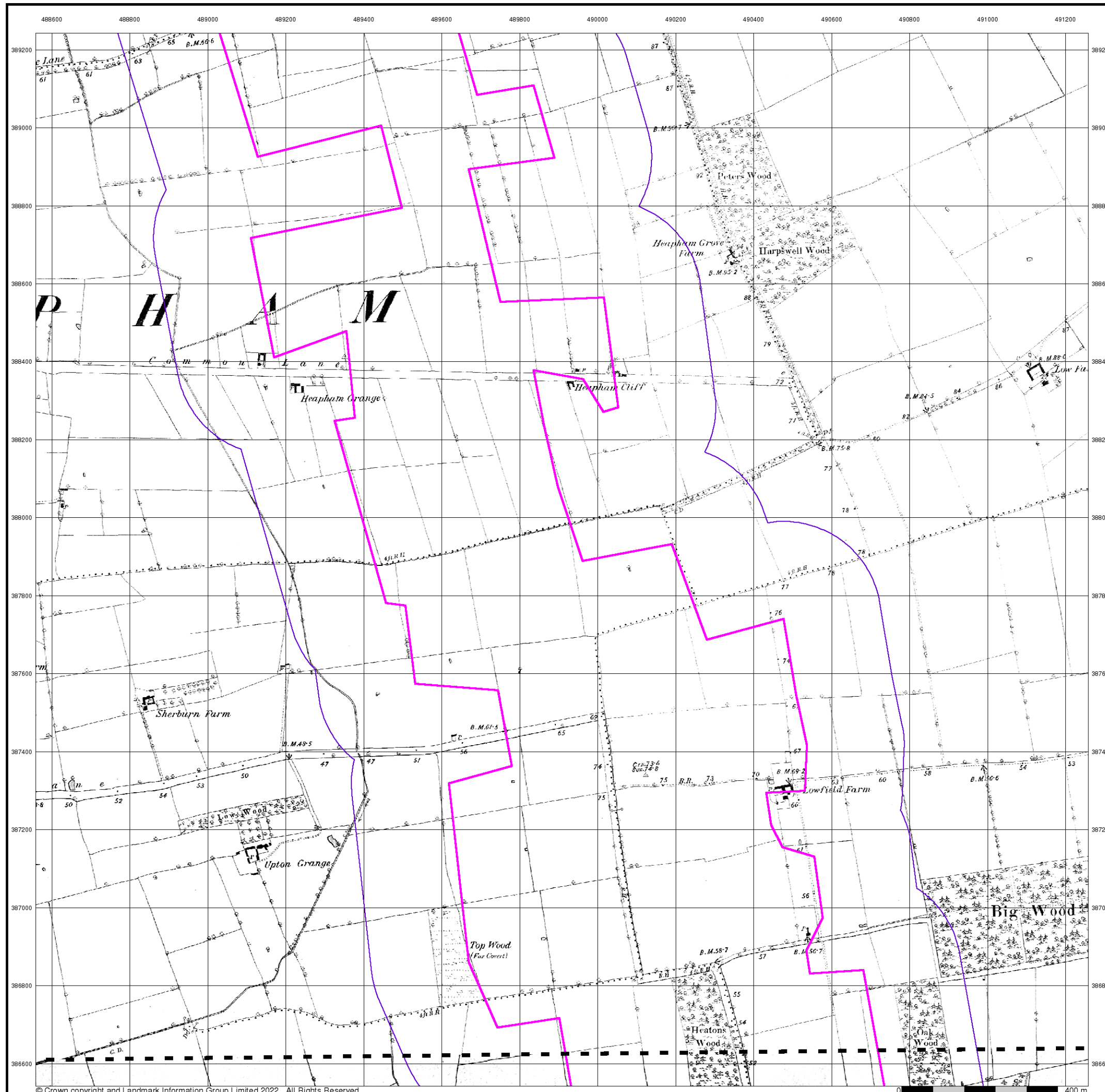

Lincolnshire

Published 1907

Source map scale - 1:10,560

The historical maps shown were reproduced from maps predominantly held at the scale adopted for England, Wales and Scotland in the 1840's. In 1854 the 1:2,500 scale was adopted for mapping urban areas; these maps were used to update the 1:10,560 maps. The published date given therefore is often some years later than the surveyed date. Before 1938, all OS maps were based on the Cassini Projection, with independent surveys of a single county or group of counties, giving rise to significant inaccuracies in outlying areas. In the late 1940's, a Provisional Edition was produced, which updated the 1:10,560 mapping from a number of sources. The maps appear unfinished - with all military camps and other strategic sites removed. These maps were initially overprinted with the National Grid. In 1970, the first 1:10,000 maps were produced using the Transverse Mercator Projection. The revision process continued until recently, with new editions appearing every 10 years or so for urban areas.

Map Name(s) and Date(s)

043SE	1907	1:10,560
051NE	1907	1:10,560

Historical Map - Slice E

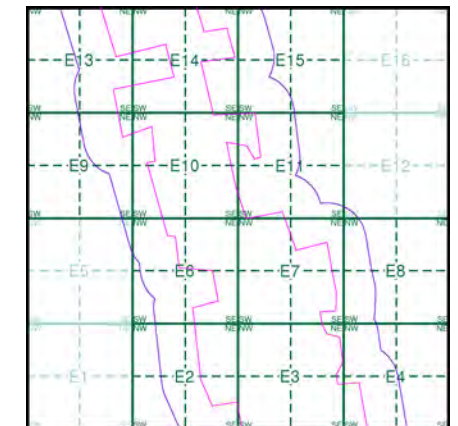

Order Details

Order Number: 297990273_1_1
 Customer Ref: 21-1088.04
 National Grid Reference: 489860, 387850
 Slice: E
 Site Area (Ha): 469.98
 Search Buffer (m): 250

Site Details

Cottam

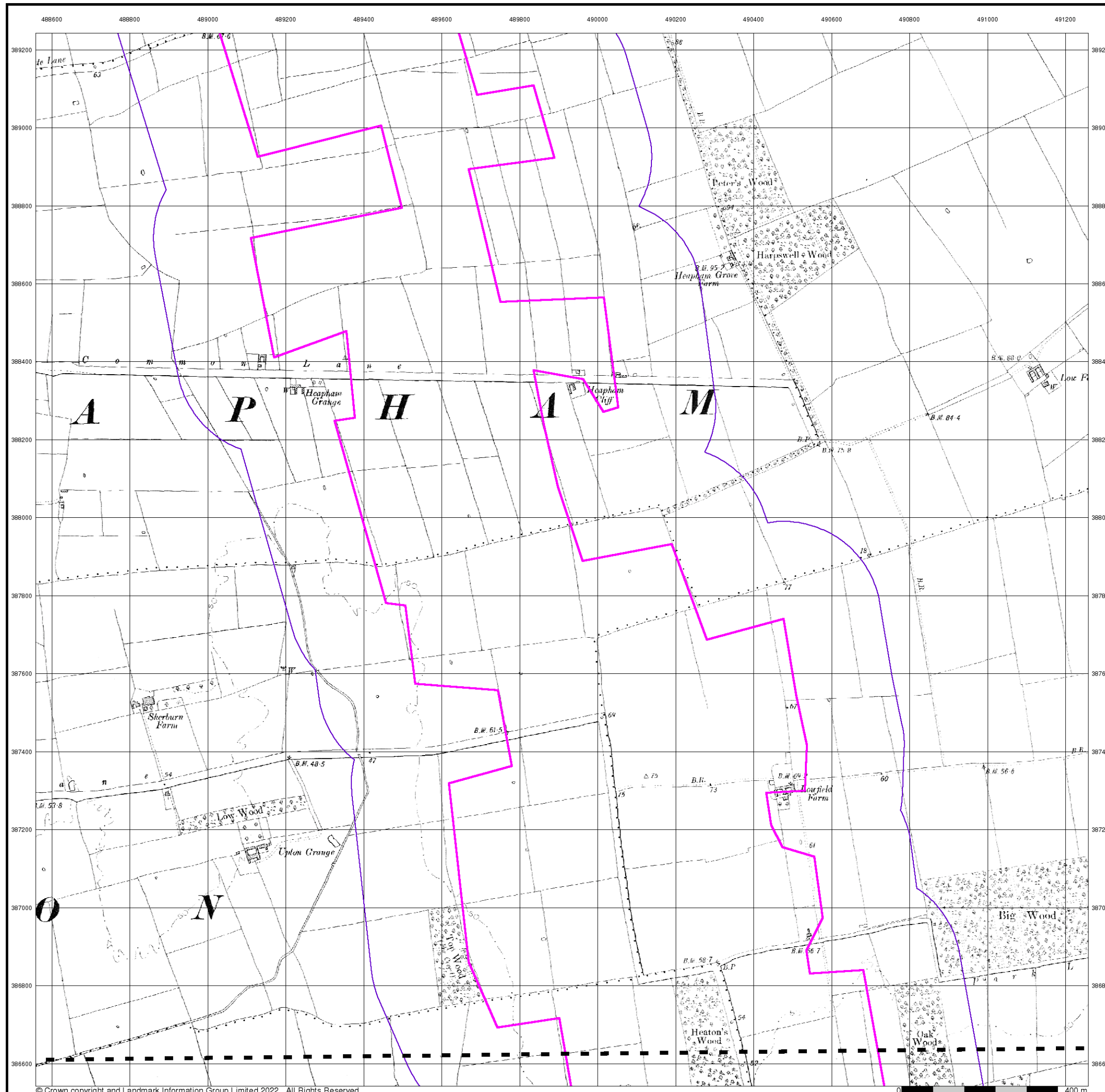

Lincolnshire

Published 1907

Source map scale - 1:10,560

The historical maps shown were reproduced from maps predominantly held at the scale adopted for England, Wales and Scotland in the 1840's. In 1854 the 1:2,500 scale was adopted for mapping urban areas; these maps were used to update the 1:10,560 maps. The published date given therefore is often some years later than the surveyed date. Before 1938, all OS maps were based on the Cassini Projection, with independent surveys of a single county or group of counties, giving rise to significant inaccuracies in outlying areas. In the late 1940's, a Provisional Edition was produced, which updated the 1:10,560 mapping from a number of sources. The maps appear unfinished - with all military camps and other strategic sites removed. These maps were initially overprinted with the National Grid. In 1970, the first 1:10,000 maps were produced using the Transverse Mercator Projection. The revision process continued until recently, with new editions appearing every 10 years or so for urban areas.

Map Name(s) and Date(s)

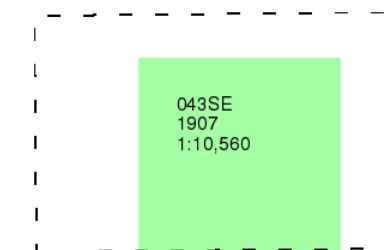

Historical Map - Slice E

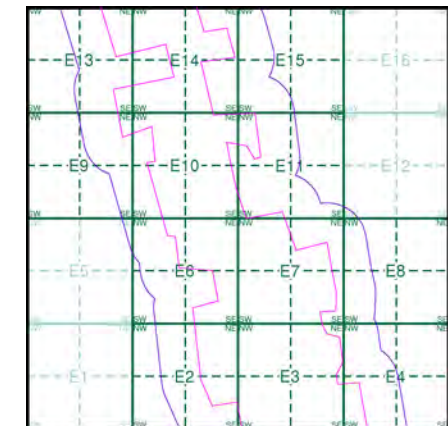

Order Details

Order Number: 297990273_1_1
 Customer Ref: 21-1088.04
 National Grid Reference: 489860, 387850
 Slice: E
 Site Area (Ha): 469.98
 Search Buffer (m): 250

Site Details

Cottam

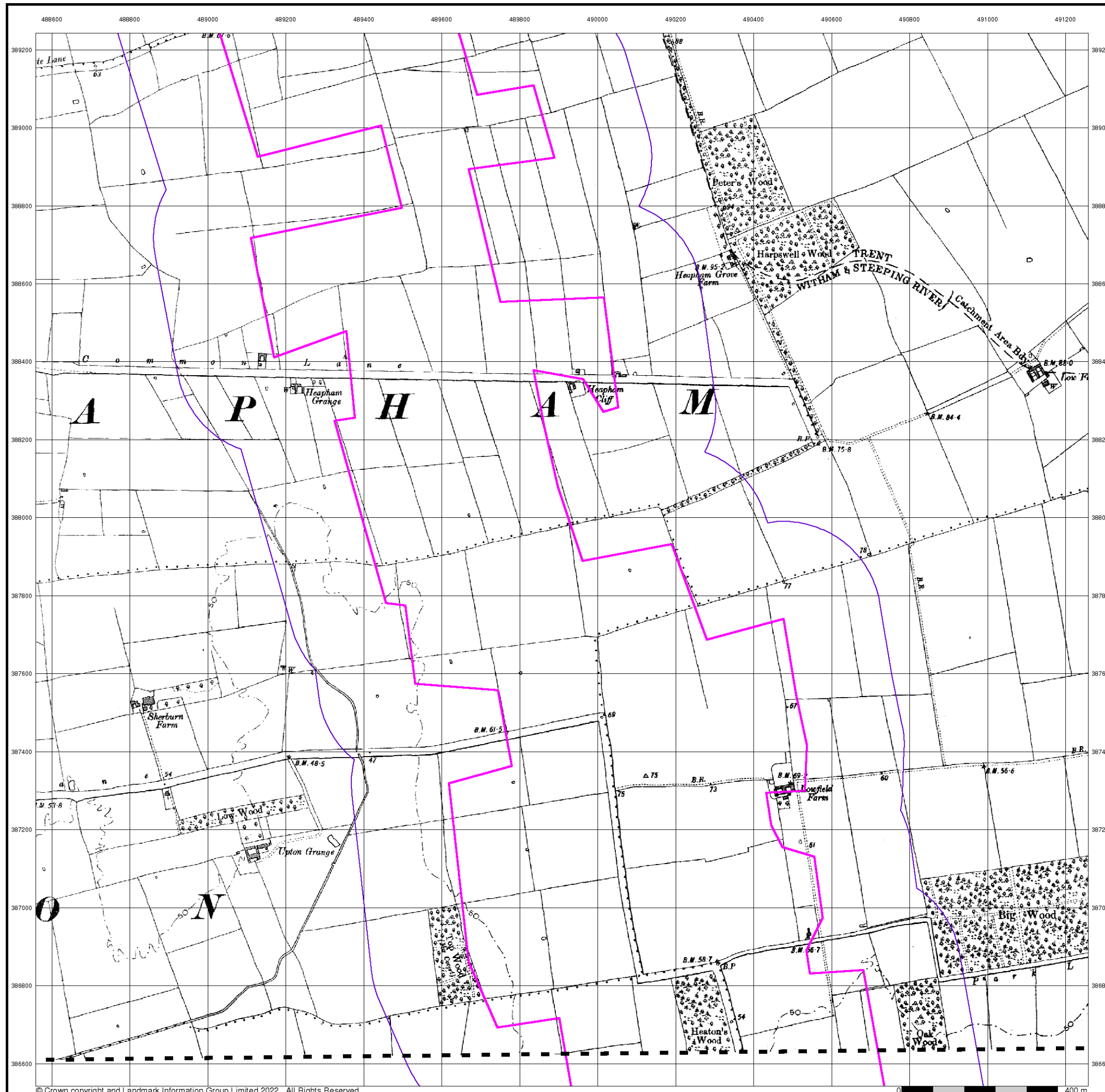

Lincolnshire

Published 1947

Source map scale - 1:10,560

The historical maps shown were reproduced from maps predominantly held at the scale adopted for England, Wales and Scotland in the 1840's. In 1854 the 1:2,500 scale was adopted for mapping urban areas; these maps were used to update the 1:10,560 maps. The published date given therefore is often some years later than the surveyed date. Before 1938, all OS maps were based on the Cassini Projection, with independent surveys of a single county or group of counties, giving rise to significant inaccuracies in outlying areas. In the late 1940's, a Provisional Edition was produced, which updated the 1:10,560 mapping from a number of sources. The maps appear unfinished - with all military camps and other strategic sites removed. These maps were initially overprinted with the National Grid. In 1970, the first 1:10,000 maps were produced using the Transverse Mercator Projection. The revision process continued until recently, with new editions appearing every 10 years or so for urban areas.

Map Name(s) and Date(s)

043SE
1947
1:10,560
051NE
1947
1:10,560

Historical Map - Slice E

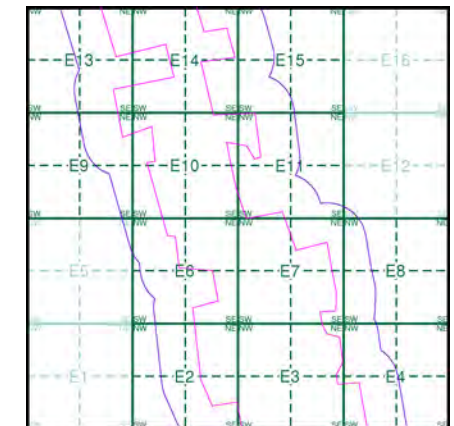

Order Details

Order Number: 297990273_1_1
 Customer Ref: 21-1088.04
 National Grid Reference: 489860, 387850
 Slice: E
 Site Area (Ha): 469.98
 Search Buffer (m): 250

Site Details

Cottam

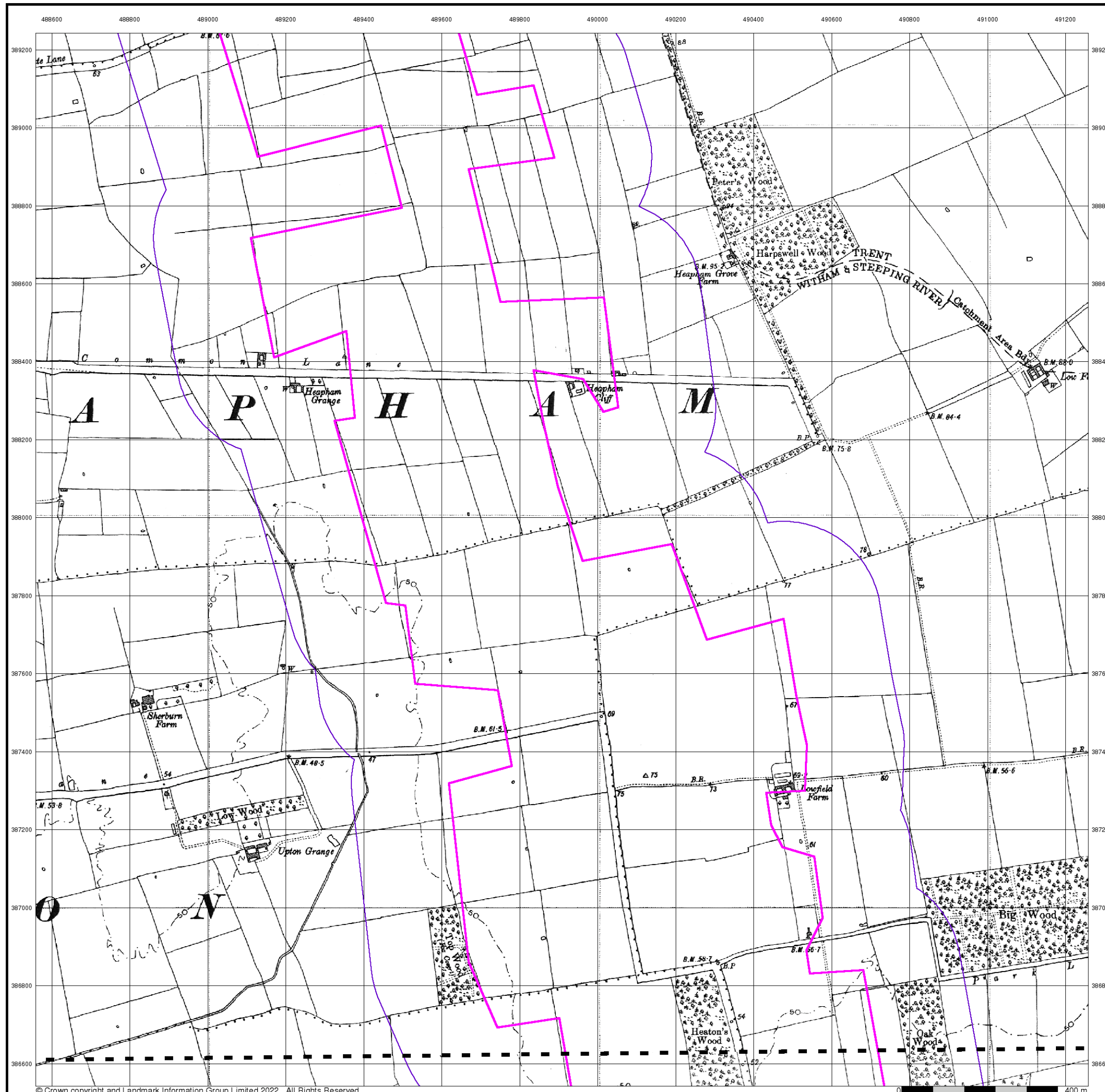

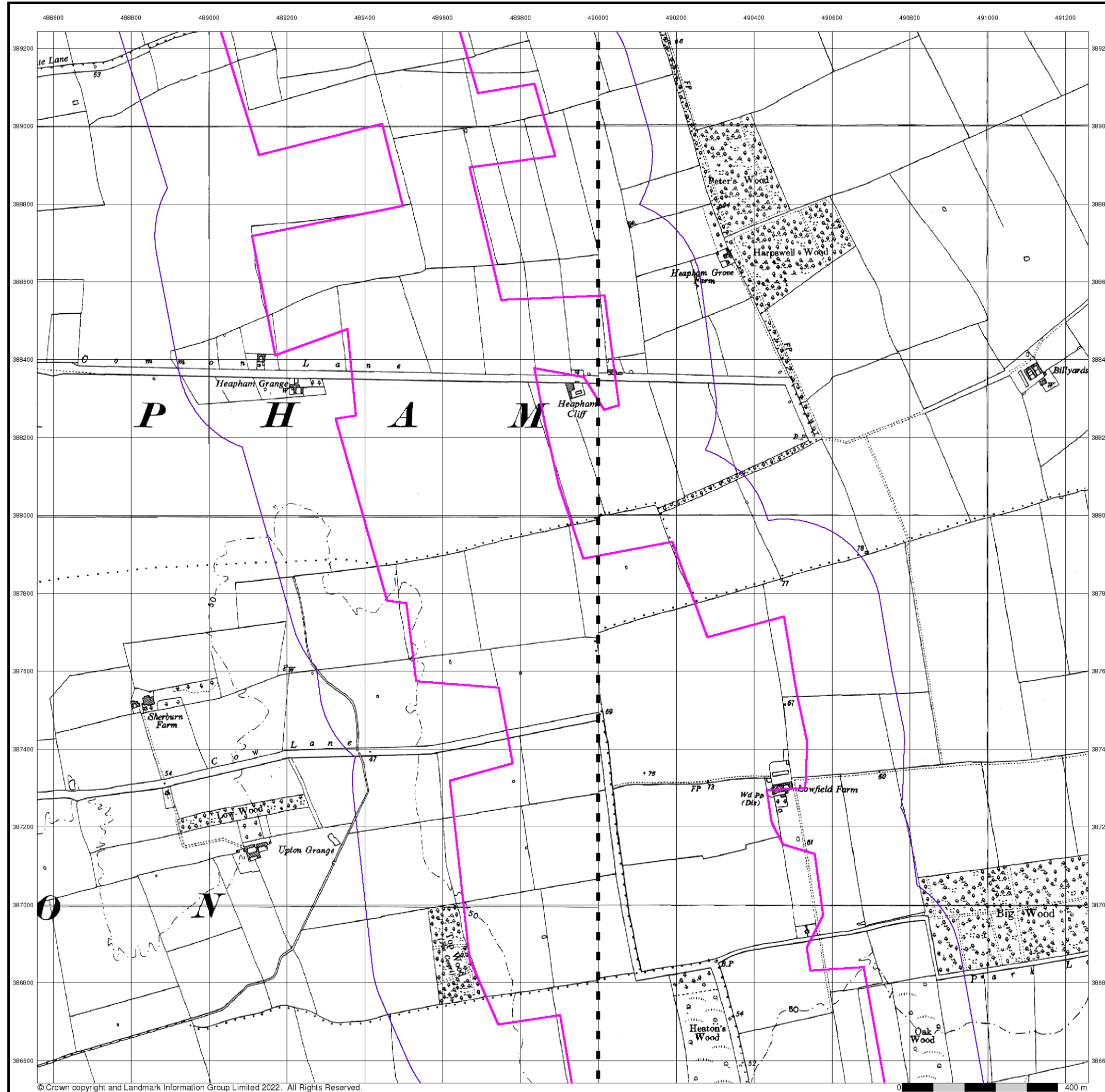

© Crown copyright and Landmark Information Group Limited 2022. All Rights Reserved.



Ordnance Survey Plan

Published 1956

Source map scale - 1:10,000

The historical maps shown were reproduced from maps predominantly held at the scale adopted for England, Wales and Scotland in the 1840's. In 1854 the 1:2,500 scale was adopted for mapping urban areas; these maps were used to update the 1:10,560 maps. The published date given therefore is often some years later than the surveyed date. Before 1938, all OS maps were based on the Cassini Projection, with independent surveys of a single county or group of counties, giving rise to significant inaccuracies in outlying areas. In the late 1940's, a Provisional Edition was produced, which updated the 1:10,560 mapping from a number of sources. The maps appear unfinished - with all military camps and other strategic sites removed. These maps were initially overprinted with the National Grid. In 1970, the first 1:10,000 maps were produced using the Transverse Mercator Projection. The revision process continued until recently, with new editions appearing every 10 years or so for urban areas.

Map Name(s) and Date(s)

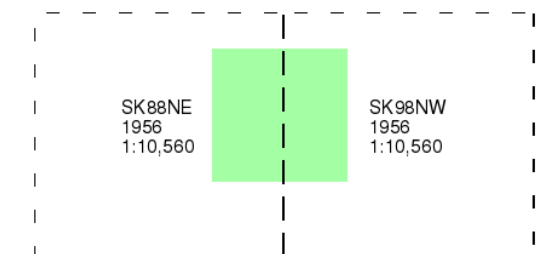

Historical Map - Slice E

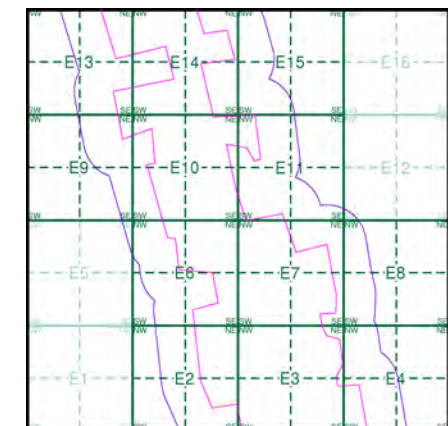

Order Details

Order Number: 297990273_1_1
 Customer Ref: 21-1088.04
 National Grid Reference: 489860, 387850
 Slice: E
 Site Area (Ha): 469.98
 Search Buffer (m): 250

Site Details

Cottam



Tel: [Redacted]
 Fax: [Redacted]
 Web: [Redacted]

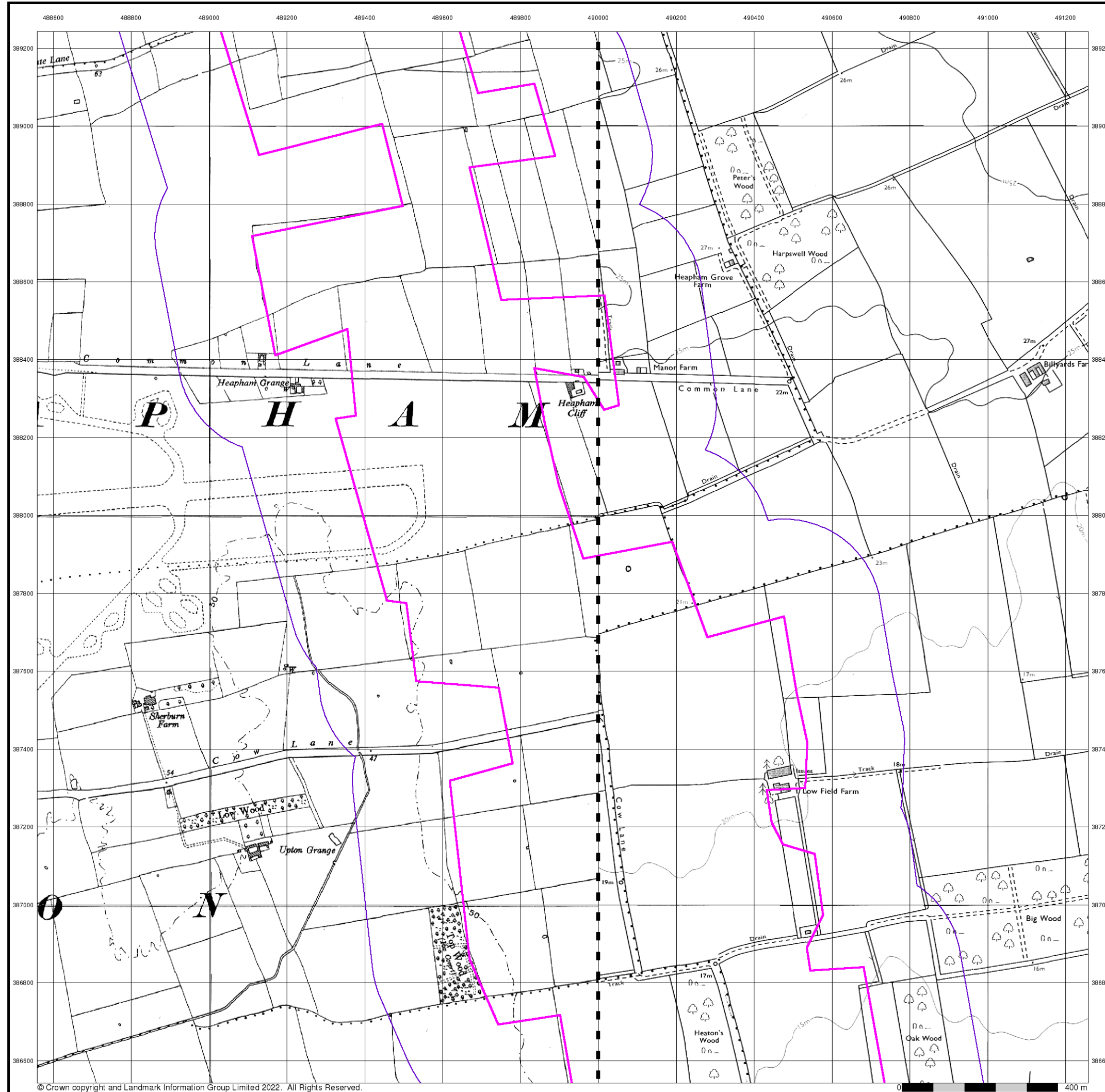

© Crown copyright and Landmark Information Group Limited 2022. All Rights Reserved.



Ordnance Survey Plan
Published 1970 - 1979
Source map scale - 1:10,000

The historical maps shown were reproduced from maps predominantly held at the scale adopted for England, Wales and Scotland in the 1840's. In 1854 the 1:2,500 scale was adopted for mapping urban areas; these maps were used to update the 1:10,560 maps. The published date given therefore is often some years later than the surveyed date. Before 1938, all OS maps were based on the Cassini Projection, with independent surveys of a single county or group of counties, giving rise to significant inaccuracies in outlying areas. In the late 1940's, a Provisional Edition was produced, which updated the 1:10,560 mapping from a number of sources. The maps appear unfinished - with all military camps and other strategic sites removed. These maps were initially overprinted with the National Grid. In 1970, the first 1:10,000 maps were produced using the Transverse Mercator Projection. The revision process continued until recently, with new editions appearing every 10 years or so for urban areas.

Map Name(s) and Date(s)

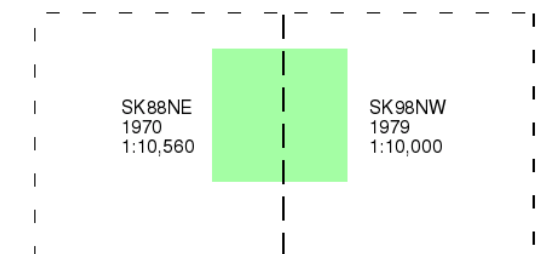

Historical Map - Slice E

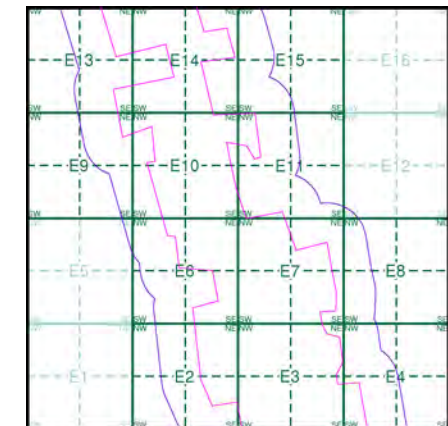

Order Details

Order Number: 297990273_1_1
 Customer Ref: 21-1088.04
 National Grid Reference: 489860, 387850
 Slice: E
 Site Area (Ha): 469.98
 Search Buffer (m): 250

Site Details

Cottam



Tel: [Redacted]
 Fax: [Redacted]
 Web: [Redacted]

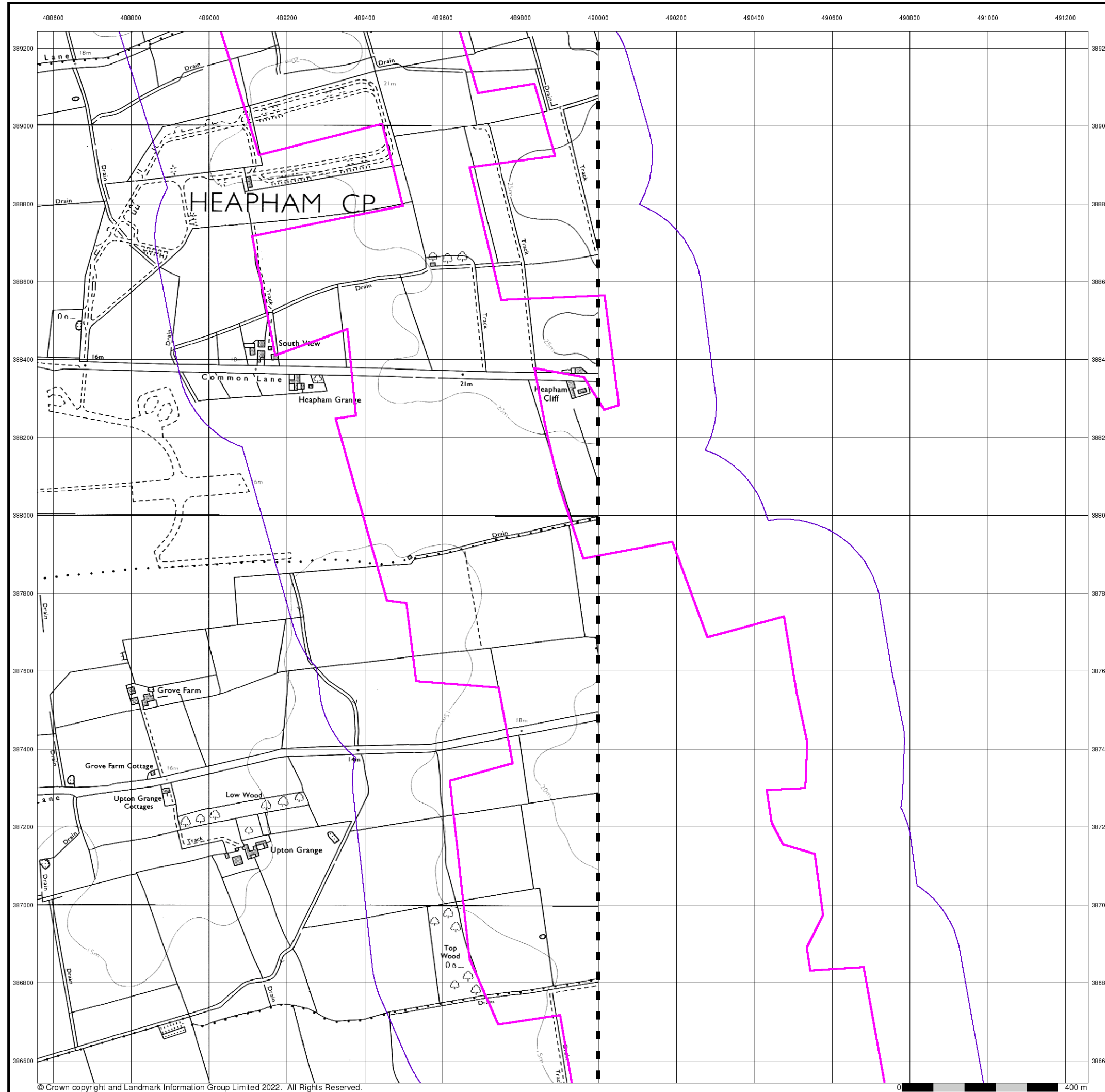

© Crown copyright and Landmark Information Group Limited 2022. All Rights Reserved.



Ordnance Survey Plan

Published 1980

Source map scale - 1:10,000

The historical maps shown were reproduced from maps predominantly held at the scale adopted for England, Wales and Scotland in the 1840's. In 1854 the 1:2,500 scale was adopted for mapping urban areas; these maps were used to update the 1:10,560 maps. The published date given therefore is often some years later than the surveyed date. Before 1938, all OS maps were based on the Cassini Projection, with independent surveys of a single county or group of counties, giving rise to significant inaccuracies in outlying areas. In the late 1940's, a Provisional Edition was produced, which updated the 1:10,560 mapping from a number of sources. The maps appear unfinished - with all military camps and other strategic sites removed. These maps were initially overprinted with the National Grid. In 1970, the first 1:10,000 maps were produced using the Transverse Mercator Projection. The revision process continued until recently, with new editions appearing every 10 years or so for urban areas.

Map Name(s) and Date(s)

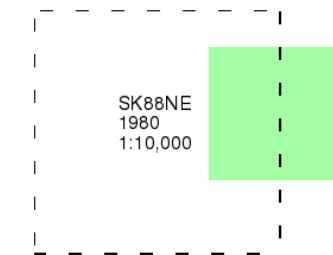

Historical Map - Slice E

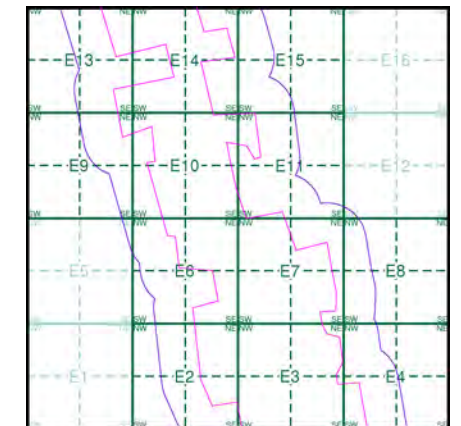

Order Details

Order Number: 297990273_1_1
 Customer Ref: 21-1088.04
 National Grid Reference: 489860, 387850
 Slice: E
 Site Area (Ha): 469.98
 Search Buffer (m): 250

Site Details

Cottam



Tel: [Redacted]
 Fax: [Redacted]
 Web: [Redacted]

10k Raster Mapping

Published 2000

Source map scale - 1:10,000

The historical maps shown were produced from the Ordnance Survey's 1:10,000 colour raster mapping. These maps are derived from Landplan which replaced the old 1:10,000 maps originally published in 1970. The data is highly detailed showing buildings, fences and field boundaries as well as all roads, tracks and paths. Road names are also included together with the relevant road number and classification. Boundary information depiction includes county, unitary authority, district, civil parish and constituency.

Map Name(s) and Date(s)

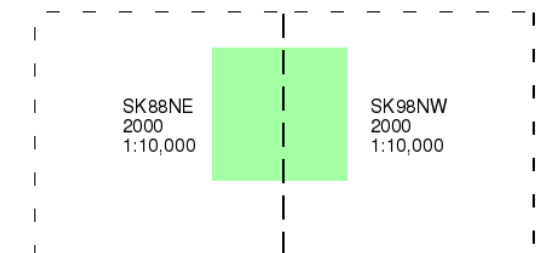

Historical Map - Slice E

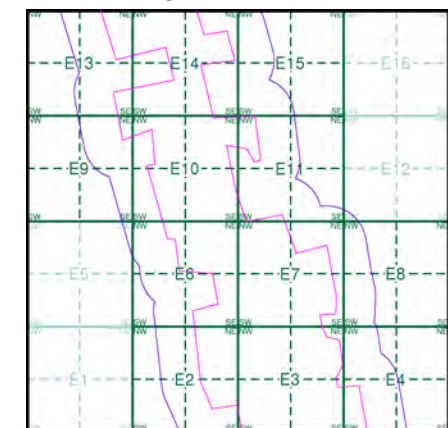

Order Details

Order Number: 297990273_1_1
 Customer Ref: 21-1088.04
 National Grid Reference: 489860, 387850
 Slice: E
 Site Area (Ha): 469.98
 Search Buffer (m): 250

Site Details

Cottam

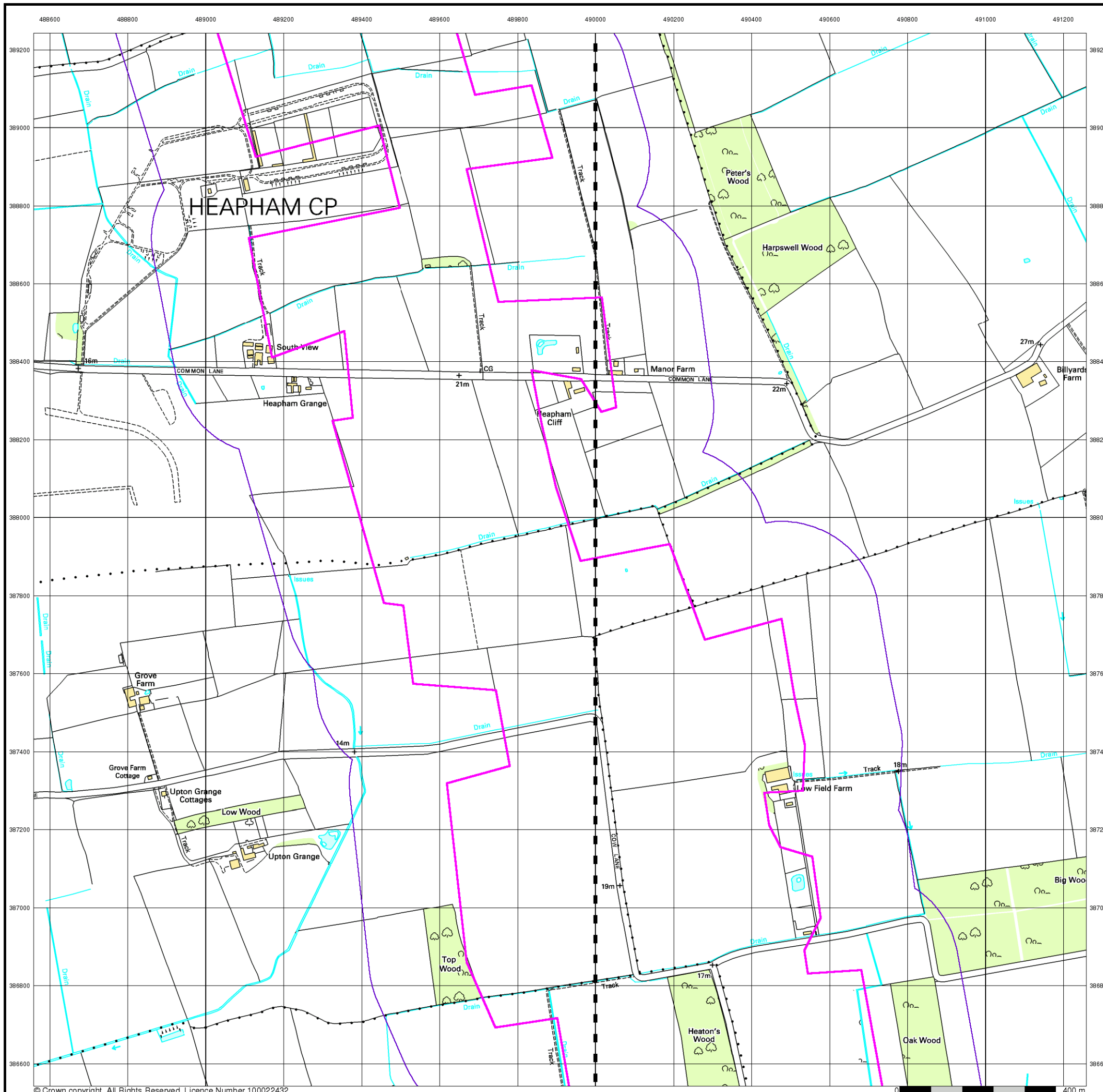

© Crown copyright. All Rights Reserved. Licence Number 100022432.

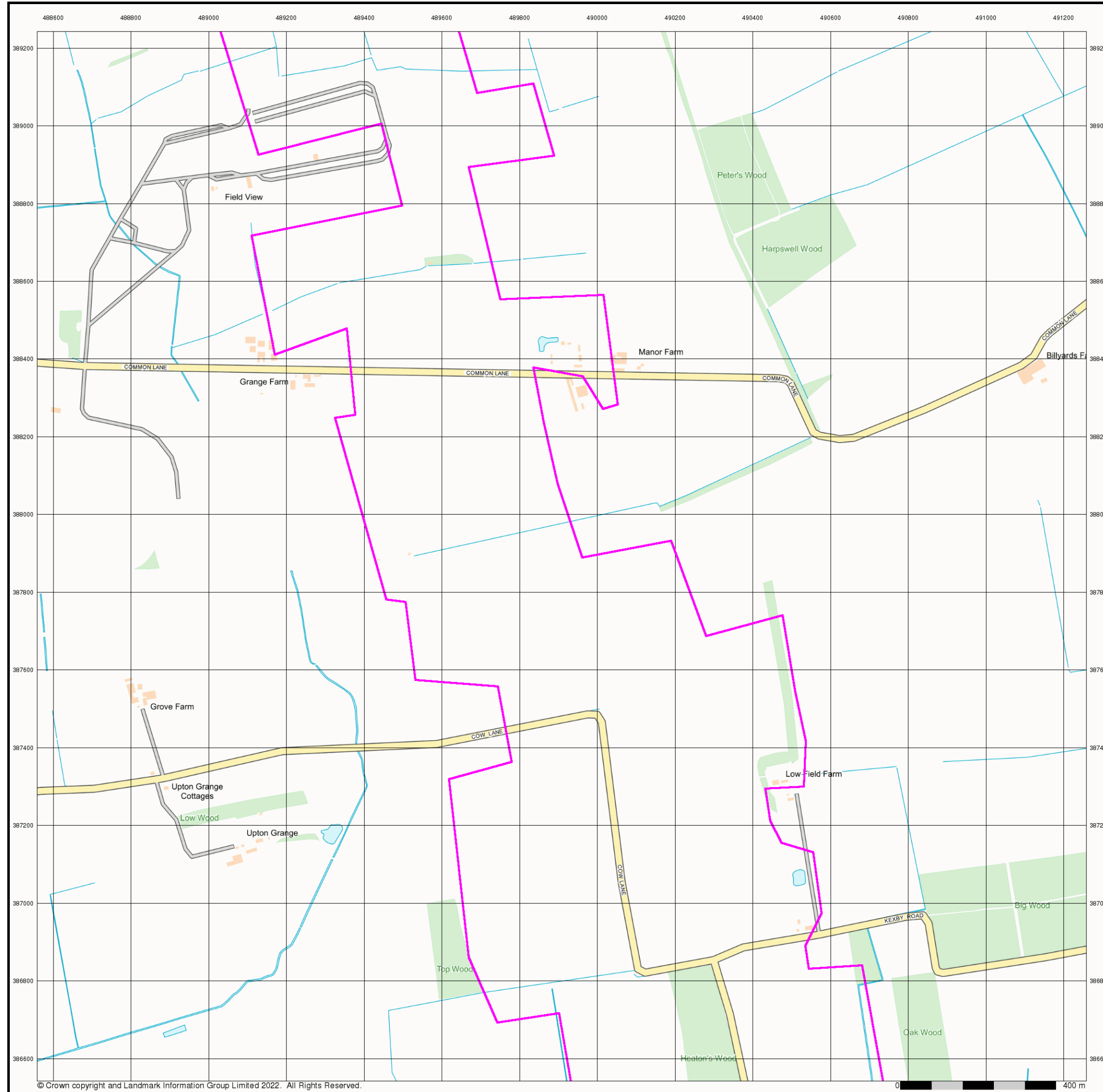

© Crown copyright and Landmark Information Group Limited 2022. All Rights Reserved.



Street View
Published 2022
Source map scale - 1:10,000

Street View is a street-level map for the whole of Great Britain produced by the Ordnance Survey. These maps are provided at a nominal scale of 1:10,000

Map Name(s) and Date(s)

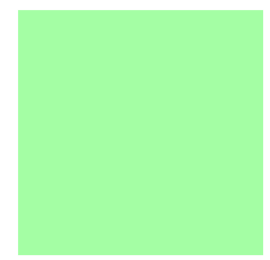

Street View Map - Slice E

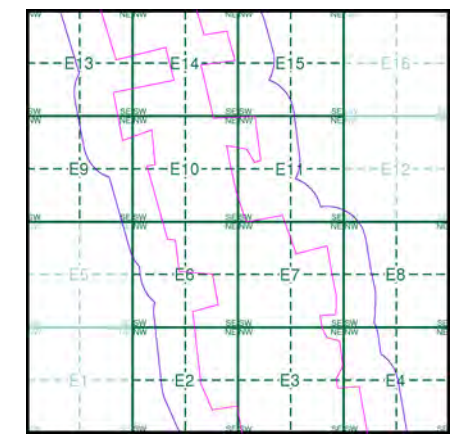

Order Details

Order Number: 297990273_1_1
 Customer Ref: 21-1088.04
 National Grid Reference: 489860, 387850
 Slice: E
 Site Area (Ha): 469.98
 Search Buffer (m): 250

Site Details

Cottam



Tel: [Redacted]
 Fax: [Redacted]
 Web: [Redacted]

Historical Mapping Legends

Ordnance Survey County Series and Ordnance Survey Plan 1:2,500

Quarry **Gravel Pit** **Sand Pit**
Clay Pit **Shingle** **Refuse Heap**
Sloping Masonry **Flat Rock**
Marsh **Reeds** **Osiers**
Rough Pasture **Furze** **Wood**
Mixed Wood **Brushwood** **Orchard**
Fir **Ford** **Stepping Stones**
Ferry **Waterfall** **Lock**
Trig. Station **Altitude at Trig. Station**
B.M. 325.9 **Bench Mark** **Surface Level**
Arrow denotes flow of water **Antiquities (site of)**
Cutting **Embankment**
Railway crossing Road **Level Crossing** **Road crossing Railway**
Railway crossing River or Canal **Road over single stream** **Road over River or Canal**
County Boundary (Geographical)
County & Civil Parish Boundary
Administrative County & Civil Parish Boundary
County Borough Boundary (England)
Co. Boro. Bdy.
County Burgh Boundary (Scotland)
Co. Burgh Bdy.
BP BS Boundary Post or Stone **P.C.B** Police Call Box
B.R. Bridle Road **P** Pump
E.P Electricity Pylon **S.P** Signal Post
F.B. Foot Bridge **SL** Sluice
F.P. Foot Path **Sp.** Spring
G.P Guide Post or Board **T.C.B** Telephone Call Box
M.S Mile Stone **Tr.** Trough
M.P M.R Mooring Post or Ring **W** Well

Ordnance Survey Plan, Additional SIMs and Supply of Unpublished Survey Information 1:2,500 and 1:1,250

Inactive Quarry, Chalk Pit or Clay Pit **Active Quarry, Chalk Pit or Clay Pit**
Rock **Boulders**
Cliff **Slopes** **Top**
Roofed Building **Glazed Roof Building**
Sloping Masonry **Archway**
Non-Coniferous Tree (surveyed) **Coniferous Tree (surveyed)**
Non-Coniferous Trees (not surveyed) **Coniferous Trees (not surveyed)**
Orchard Tree **Scrub** **Bracken**
Coppice, Osier **Reeds** **Marsh, Saltings**
Rough Grassland **Heath** **Culvert**
Direction of water flow **Bench Mark** **Antiquity (site of)**
Cave Entrance **Triangulation Station** **Electricity Pylon**
Electricity Transmission Line
County Boundary (Geographical)
County & Civil Parish Boundary
Civil Parish Boundary
Admin. County or County Bor. Boundary
London Borough Boundary
Symbol marking point where boundary mereing changes
BH Beer House **P** Pillar, Pole or Post
BP, BS Boundary Post or Stone **PO** Post Office
Cn, C Capstan, Crane **PC** Public Convenience
Chy Chimney **PH** Public House
D Fn Drinking Fountain **Pp** Pump
EI P Electricity Pillar or Post **SB, S Br** Signal Box or Bridge
FAP Fire Alarm Pillar **SP, SL** Signal Post or Light
FB Foot Bridge **Spr** Spring
GP Guide Post **Tk** Tank or Track
H Hydrant or Hydraulic **TCB** Telephone Call Box
LC Level Crossing **TCP** Telephone Call Post
MH Manhole **Tr** Trough
MP Mile Post or Mooring Post **Wr Pt, Wr T** Water Point, Water Tap
MS Mile Stone **W** Well
NTL Normal Tidal Limit **Wd Pp** Wind Pump

Large-Scale National Grid Data 1:2,500 and 1:1,250

Cliff **Slopes** **Top**
Rock **Rock (scattered)**
Boulders **Boulders (scattered)**
Positioned Boulder **Scree**
Non-Coniferous Tree (surveyed) **Coniferous Tree (surveyed)**
Non-Coniferous Trees (not surveyed) **Coniferous Trees (not surveyed)**
Orchard Tree **Scrub** **Bracken**
Coppice, Osier **Reeds** **Marsh, Saltings**
Rough Grassland **Heath** **Culvert**
Direction of water flow **Triangulation Station** **Antiquity (site of)**
Electricity Transmission Line **Electricity Pylon**
B.M. 231.60m Bench Mark **Buildings with Building Seed**
Roofed Building **Glazed Roof Building**
Civil parish/community boundary
District boundary
County boundary
Boundary post/stone
Boundary mereing symbol (note: these always appear in opposed pairs or groups of three)
Bks Barracks **P** Pillar, Pole or Post
Bty Battery **PO** Post Office
Cemy Cemetery **PC** Public Convenience
Chy Chimney **Pp** Pump
Cis Cistern **Ppg Sta** Pumping Station
Dismtd Rly Dismantled Railway **PW** Place of Worship
EI Gen Sta Electricity Generating Station **Sewage Ppg Sta** Sewage Pumping Station
EI P Electricity Pole, Pillar **SB, S Br** Signal Box or Bridge
EI Sub Sta Electricity Sub Station **SP, SL** Signal Post or Light
FB Filter Bed **Spr** Spring
Fn / D Fn Fountain / Drinking Ftn. **Tk** Tank or Track
Gas Gov Gas Valve Compound **Tr** Trough
GVC Gas Governor **Wd Pp** Wind Pump
GP Guide Post **Wr Pt, Wr T** Water Point, Water Tap
MH Manhole **Wks** Works (building or area)
MP, MS Mile Post or Mile Stone **W** Well



Historical Mapping & Photography included:

Mapping Type	Scale	Date	Pg
Lincolnshire	1:2,500	1886	2
Lincolnshire	1:2,500	1906	3
Ordnance Survey Plan	1:2,500	1972 - 1973	4
Large-Scale National Grid Data	1:2,500	1994	5

Historical Map - Segment E2

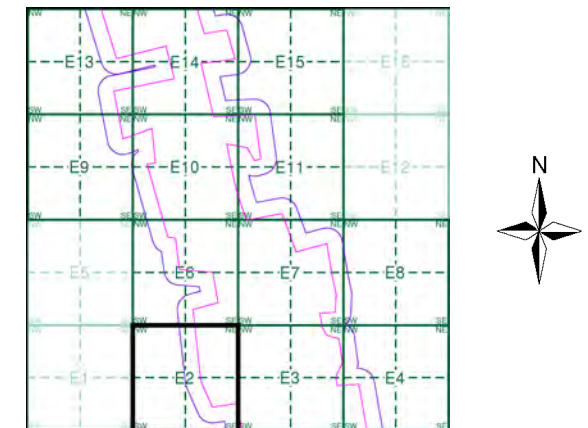

Order Details

Order Number: 297990273_1_1
 Customer Ref: 21-1088.04
 National Grid Reference: 489860, 387850
 Slice: E
 Site Area (Ha): 469.98
 Search Buffer (m): 100

Site Details

Cottam



Tel: [Redacted]
 Fax: [Redacted]
 Web: [Redacted]

Lincolnshire
Published 1886

Source map scale - 1:2,500

The historical maps shown were reproduced from maps predominantly held at the scale adopted for England, Wales and Scotland in the 1840's. In 1854 the 1:2,500 scale was adopted for mapping urban areas and by 1896 it covered the whole of what were considered to be the cultivated parts of Great Britain. The published date given below is often some years later than the surveyed date. Before 1938, all OS maps were based on the Cassini Projection, with independent surveys of a single county or group of counties, giving rise to significant inaccuracies in outlying areas.

Map Name(s) and Date(s)

043_15 1886 1:2,500	043_16 1886 1:2,500
051_03 1886 1:2,500	051_04 1886 1:2,500

Historical Map - Segment E2

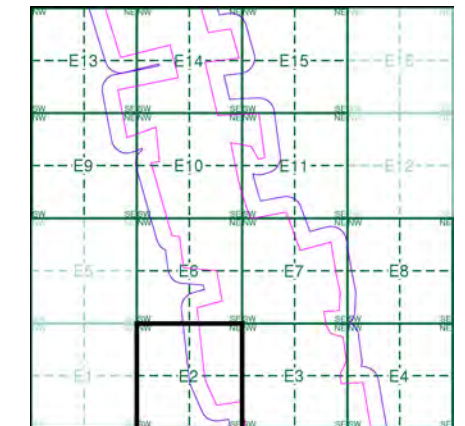

Order Details

Order Number: 297990273_1_1
Customer Ref: 21-1088.04
National Grid Reference: 489860, 387850
Slice: E
Site Area (Ha): 469.98
Search Buffer (m): 100

Site Details

Cottam

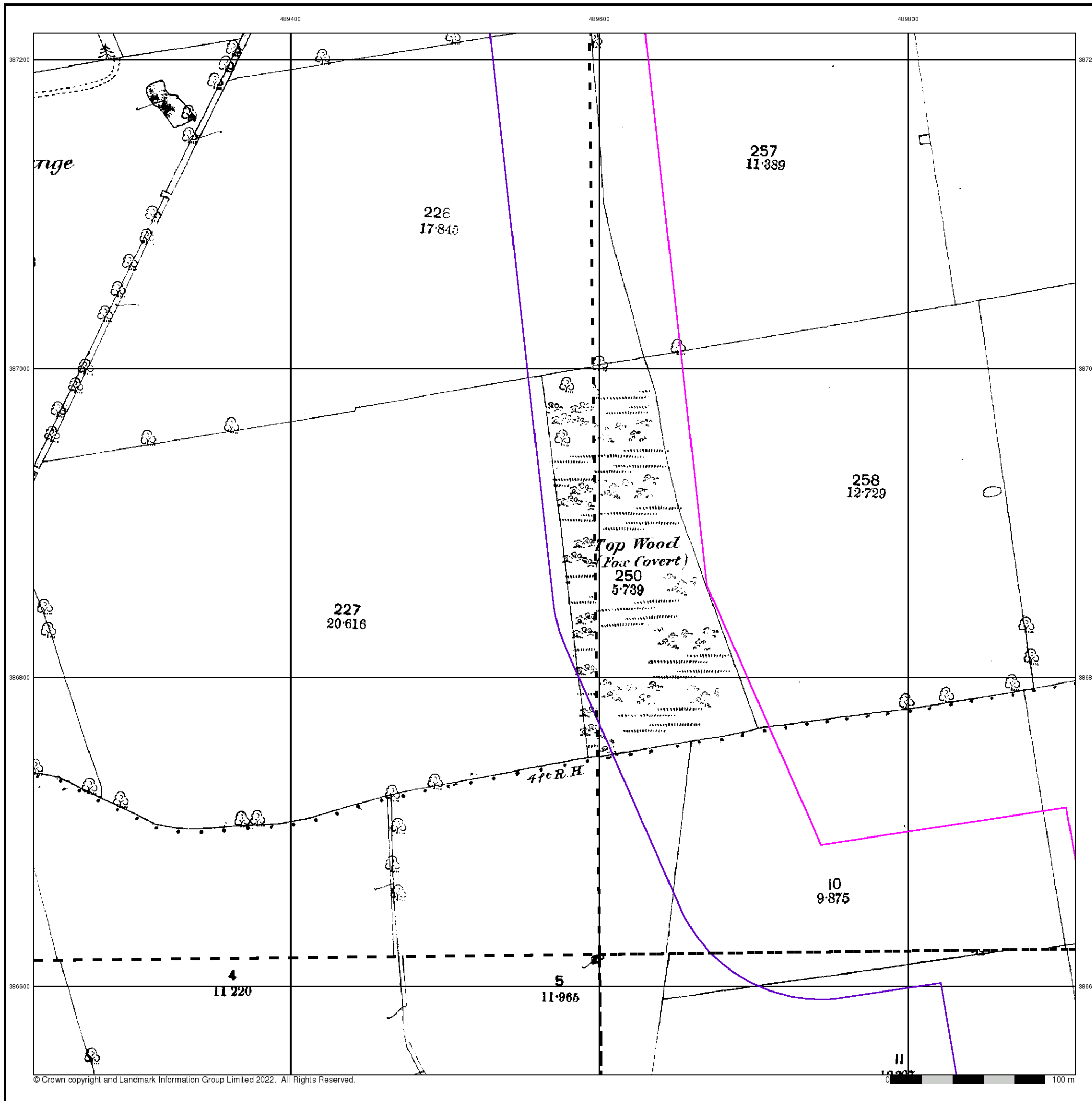

Lincolnshire

Published 1906

Source map scale - 1:2,500

The historical maps shown were reproduced from maps predominantly held at the scale adopted for England, Wales and Scotland in the 1840's. In 1854 the 1:2,500 scale was adopted for mapping urban areas and by 1896 it covered the whole of what were considered to be the cultivated parts of Great Britain. The published date given below is often some years later than the surveyed date. Before 1938, all OS maps were based on the Cassini Projection, with independent surveys of a single county or group of counties, giving rise to significant inaccuracies in outlying areas.

Map Name(s) and Date(s)

043_15 1906 1:2,500	043_16 1906 1:2,500
051_03 1906 1:2,500	051_04 1906 1:2,500

Historical Map - Segment E2

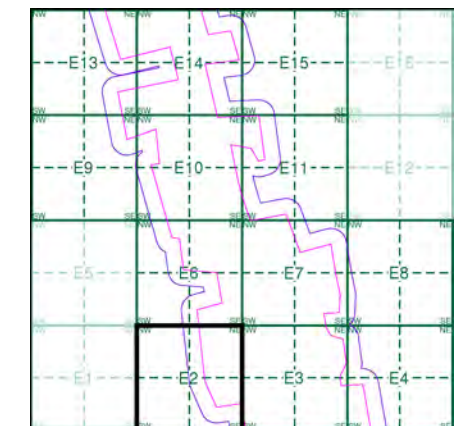

Order Details

Order Number: 297990273_1_1
 Customer Ref: 21-1088.04
 National Grid Reference: 489860, 387850
 Slice: E
 Site Area (Ha): 469.98
 Search Buffer (m): 100

Site Details

Cottam

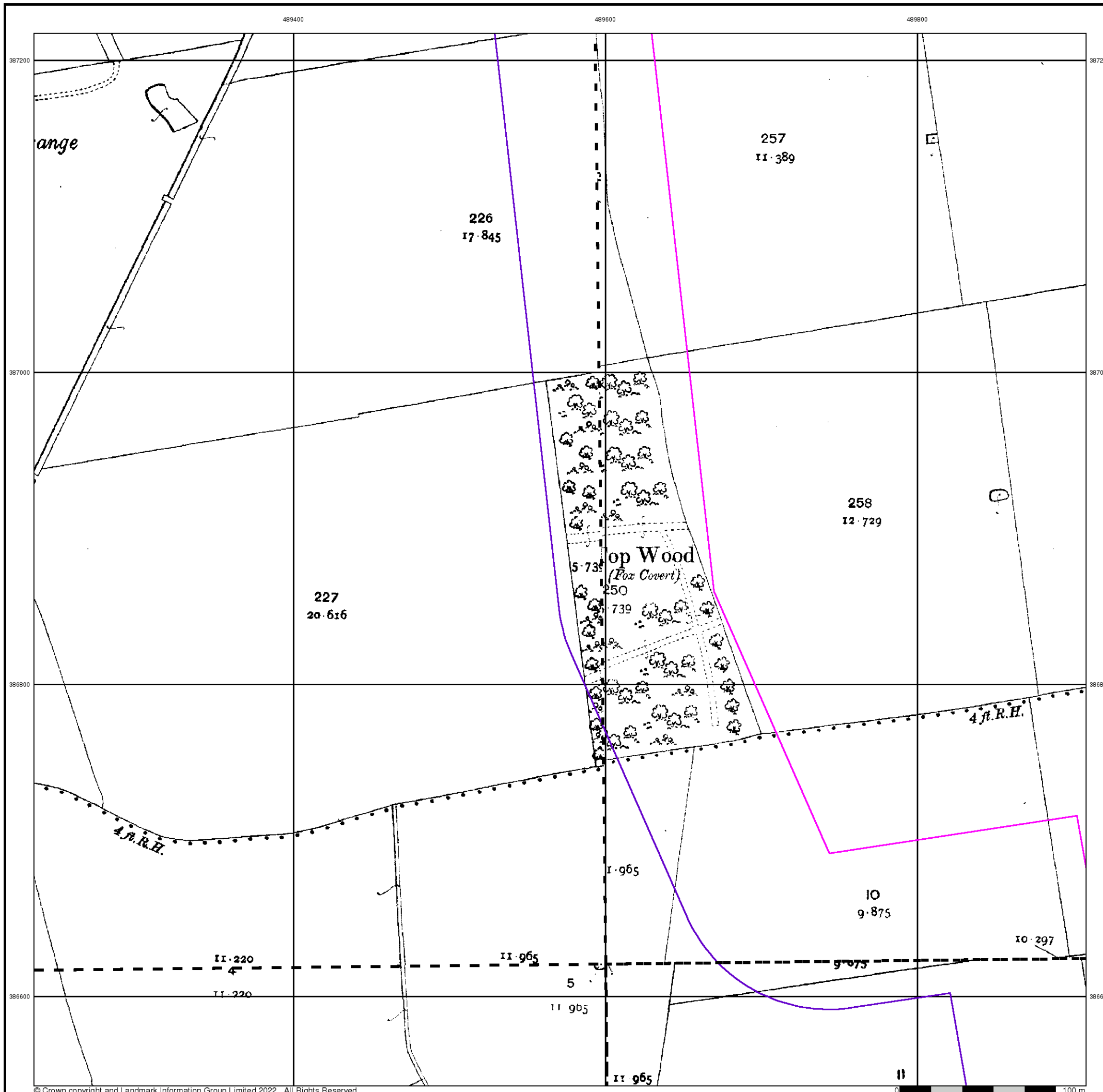

Ordnance Survey Plan
Published 1972 - 1973
Source map scale - 1:2,500

The historical maps shown were reproduced from maps predominantly held at the scale adopted for England, Wales and Scotland in the 1840's. In 1854 the 1:2,500 scale was adopted for mapping urban areas and by 1896 it covered the whole of what were considered to be the cultivated parts of Great Britain. The published date given below is often some years later than the surveyed date. Before 1938, all OS maps were based on the Cassini Projection, with independent surveys of a single county or group of counties, giving rise to significant inaccuracies in outlying areas.

Map Name(s) and Date(s)

SK8987	1973	1:2,500
SK8986	1972	1:2,500

Historical Map - Segment E2

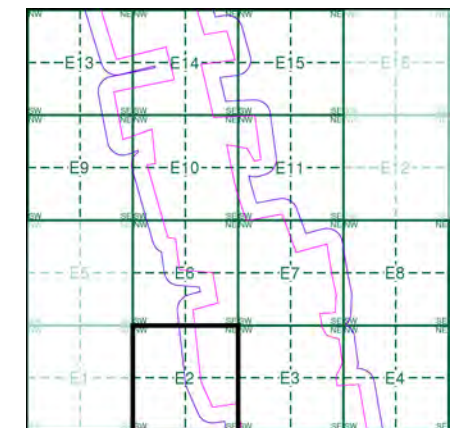

Order Details

Order Number: 297990273_1_1
 Customer Ref: 21-1088.04
 National Grid Reference: 489860, 387850
 Slice: E
 Site Area (Ha): 469.98
 Search Buffer (m): 100

Site Details

Cottam



**Large-Scale National Grid Data
Published 1994
Source map scale - 1:2,500**

'Large Scale National Grid Data' superseded SIM cards (Ordnance Survey's 'Survey of Information on Microfilm') in 1992, and continued to be produced until 1999. These maps were the fore-runners of digital mapping and so provide detailed information on houses and roads, but tend to show less topographic features such as vegetation. These maps were produced at both 1:2,500 and 1:1,250 scales.

Map Name(s) and Date(s)

SK8987	1994	1:2,500
SK8986	1994	1:2,500

Historical Map - Segment E2

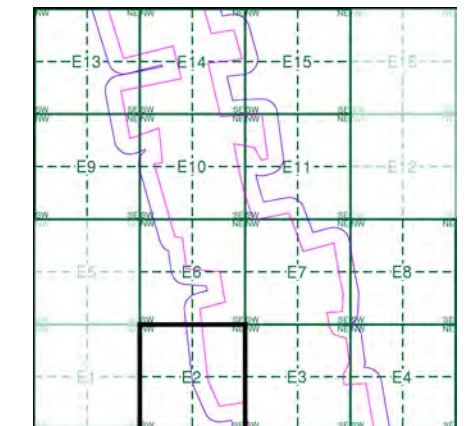

Order Details

Order Number: 297990273_1_1
 Customer Ref: 21-1088.04
 National Grid Reference: 489860, 387850
 Slice: E
 Site Area (Ha): 469.98
 Search Buffer (m): 100

Site Details

Cottam

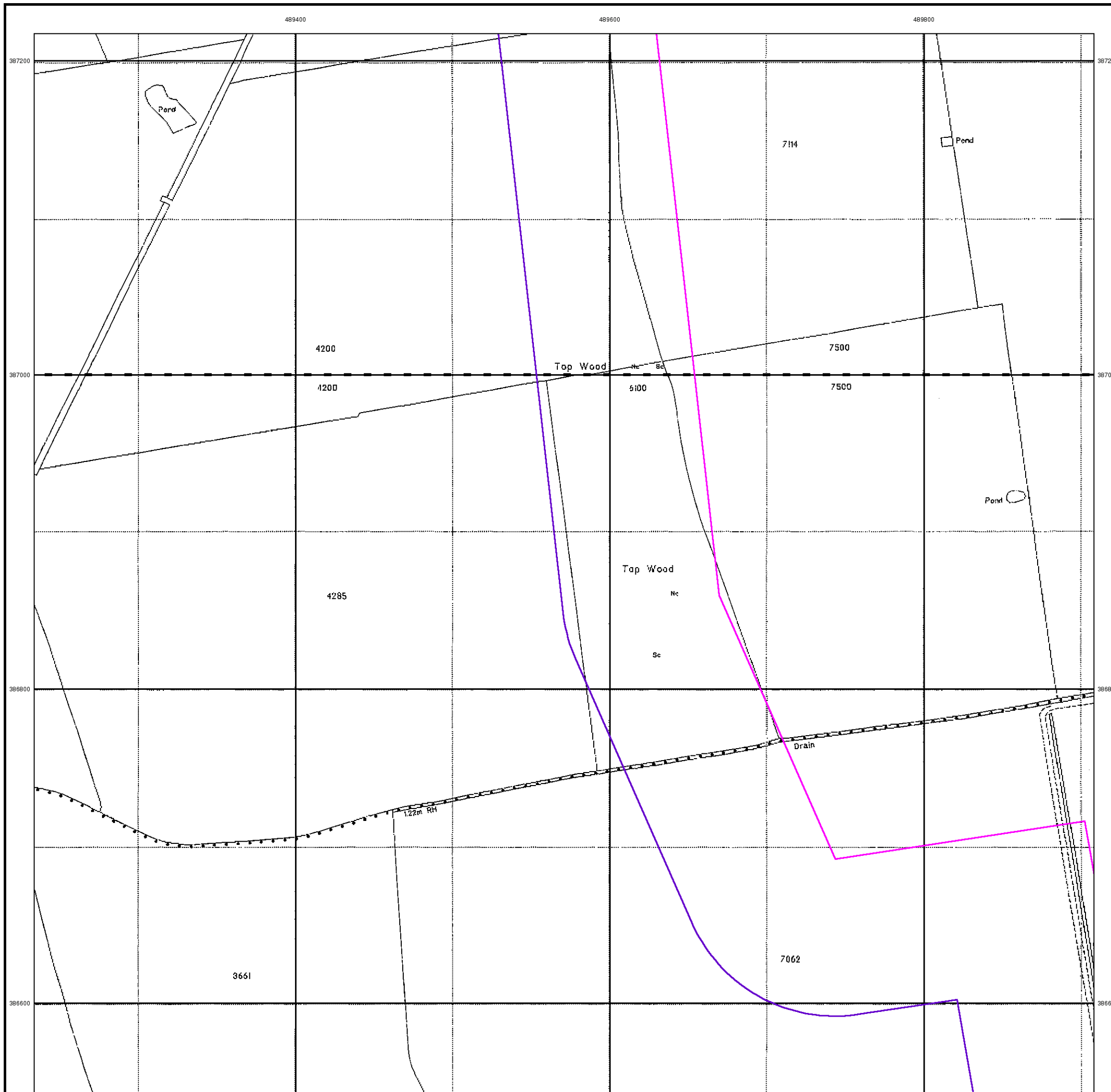

Historical Mapping Legends

Ordnance Survey County Series and Ordnance Survey Plan 1:2,500

Quarry **Gravel Pit** **Sand Pit**
Clay Pit **Shingle** **Refuse Heap**
Sloping Masonry **Flat Rock**
Marsh **Reeds** **Osiers**
Rough Pasture **Furze** **Wood**
Mixed Wood **Brushwood** **Orchard**
Fir **Ford** **Stepping Stones**
Ferry **Waterfall** **Lock**
Trig. Station **Altitude at Trig. Station**
B.M. 325.9 **Bench Mark** **Surface Level**
Arrow denotes flow of water **Antiquities (site of)**
Cutting **Embankment**
Railway crossing Road **Level Crossing** **Road crossing Railway**
Railway crossing River or Canal **Road over single stream** **Road over River or Canal**
County Boundary (Geographical)
County & Civil Parish Boundary
Administrative County & Civil Parish Boundary
County Borough Boundary (England)
Co. Boro. Bdy.
County Burgh Boundary (Scotland)
Co. Burgh Bdy.
BP BS Boundary Post or Stone **P.C.B** Police Call Box
B.R. Bridle Road **P** Pump
E.P Electricity Pylon **S.P** Signal Post
F.B. Foot Bridge **SL** Sluice
F.P. Foot Path **Sp.** Spring
G.P Guide Post or Board **T.C.B** Telephone Call Box
M.S Mile Stone **Tr.** Trough
M.P M.R Mooring Post or Ring **W** Well

Ordnance Survey Plan, Additional SIMs and Supply of Unpublished Survey Information 1:2,500 and 1:1,250

Inactive Quarry, Chalk Pit or Clay Pit **Active Quarry, Chalk Pit or Clay Pit**
Rock **Boulders**
Cliff **Slopes** **Top**
Roofed Building **Glazed Roof Building**
Sloping Masonry **Archway**
Non-Coniferous Tree (surveyed) **Coniferous Tree (surveyed)**
Non-Coniferous Trees (not surveyed) **Coniferous Trees (not surveyed)**
Orchard Tree **Scrub** **Bracken**
Coppice, Osier **Reeds** **Marsh, Saltings**
Rough Grassland **Heath** **Culvert**
Direction of water flow **Bench Mark** **Antiquity (site of)**
Cave Entrance **Triangulation Station** **Electricity Pylon**
Electricity Transmission Line
County Boundary (Geographical)
County & Civil Parish Boundary
Civil Parish Boundary
Admin. County or County Bor. Boundary
London Borough Boundary
Symbol marking point where boundary mereing changes
BH Beer House **P** Pillar, Pole or Post
BP, BS Boundary Post or Stone **PO** Post Office
Cn, C Capstan, Crane **PC** Public Convenience
Chy Chimney **PH** Public House
D Fn Drinking Fountain **Pp** Pump
EI P Electricity Pillar or Post **SB, S Br** Signal Box or Bridge
FAP Fire Alarm Pillar **SP, SL** Signal Post or Light
FB Foot Bridge **Spr** Spring
GP Guide Post **Tk** Tank or Track
H Hydrant or Hydraulic **TCB** Telephone Call Box
LC Level Crossing **TCP** Telephone Call Post
MH Manhole **Tr** Trough
MP Mile Post or Mooring Post **Wr Pt, Wr T** Water Point, Water Tap
MS Mile Stone **W** Well
NTL Normal Tidal Limit **Wd Pp** Wind Pump

Large-Scale National Grid Data 1:2,500 and 1:1,250

Cliff **Slopes** **Top**
Rock **Rock (scattered)**
Boulders **Boulders (scattered)**
Positioned Boulder **Scree**
Non-Coniferous Tree (surveyed) **Coniferous Tree (surveyed)**
Non-Coniferous Trees (not surveyed) **Coniferous Trees (not surveyed)**
Orchard Tree **Scrub** **Bracken**
Coppice, Osier **Reeds** **Marsh, Saltings**
Rough Grassland **Heath** **Culvert**
Direction of water flow **Triangulation Station** **Antiquity (site of)**
Electricity Transmission Line **Electricity Pylon**
BM 231.60m Bench Mark **Buildings with Building Seed**
Roofed Building **Glazed Roof Building**
Civil parish/community boundary
District boundary
County boundary
Boundary post/stone
Boundary mereing symbol (note: these always appear in opposed pairs or groups of three)
Bks Barracks **P** Pillar, Pole or Post
Bty Battery **PO** Post Office
Cemy Cemetery **PC** Public Convenience
Chy Chimney **Pp** Pump
Cis Cistern **Ppg Sta** Pumping Station
Dismtd Rly Dismantled Railway **PW** Place of Worship
EI Gen Sta Electricity Generating Station **Sewage Ppg Sta** Sewage Pumping Station
EI P Electricity Pole, Pillar **SB, S Br** Signal Box or Bridge
EI Sub Sta Electricity Sub Station **SP, SL** Signal Post or Light
FB Filter Bed **Spr** Spring
Fn / D Fn Fountain / Drinking Ftn. **Tk** Tank or Track
Gas Gov Gas Valve Compound **Tr** Trough
GVC Gas Governor **Wd Pp** Wind Pump
GP Guide Post **Wr Pt, Wr T** Water Point, Water Tap
MH Manhole **Wks** Works (building or area)
MP, MS Mile Post or Mile Stone **W** Well



Historical Mapping & Photography included:

Mapping Type	Scale	Date	Pg
Lincolnshire	1:2,500	1886	2
Lincolnshire	1:2,500	1906	3
Ordnance Survey Plan	1:2,500	1972 - 1974	4
Large-Scale National Grid Data	1:2,500	1994	5

Historical Map - Segment E3

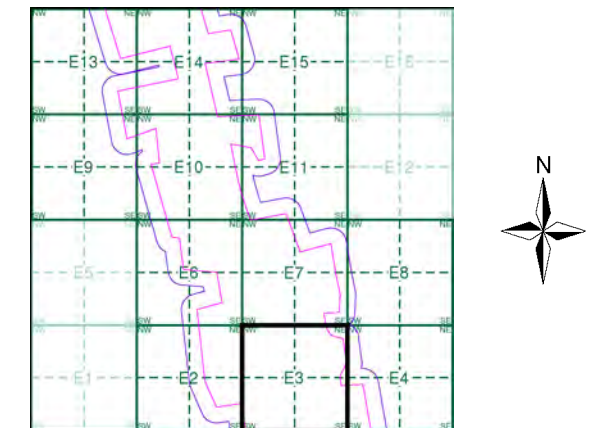

Order Details

Order Number: 297990273_1_1
 Customer Ref: 21-1088.04
 National Grid Reference: 489860, 387850
 Slice: E
 Site Area (Ha): 469.98
 Search Buffer (m): 100

Site Details

Cottam



Tel: [Redacted]
 Fax: [Redacted]
 Web: [Redacted]

Lincolnshire

Published 1886

Source map scale - 1:2,500

The historical maps shown were reproduced from maps predominantly held at the scale adopted for England, Wales and Scotland in the 1840's. In 1854 the 1:2,500 scale was adopted for mapping urban areas and by 1896 it covered the whole of what were considered to be the cultivated parts of Great Britain. The published date given below is often some years later than the surveyed date. Before 1938, all OS maps were based on the Cassini Projection, with independent surveys of a single county or group of counties, giving rise to significant inaccuracies in outlying areas.

Map Name(s) and Date(s)

043_16	1886	1:2,500
051_04	1886	1:2,500

Historical Map - Segment E3

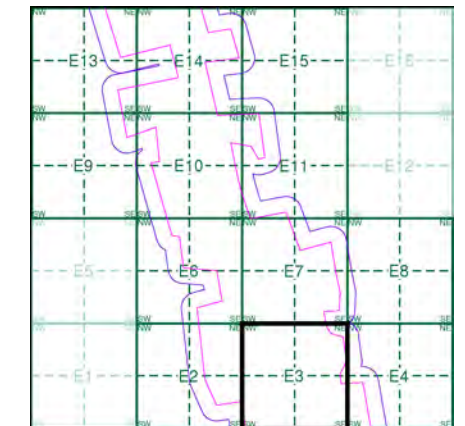

Order Details

Order Number: 297990273_1_1
 Customer Ref: 21-1088.04
 National Grid Reference: 489860, 387850
 Slice: E
 Site Area (Ha): 469.98
 Search Buffer (m): 100

Site Details

Cottam

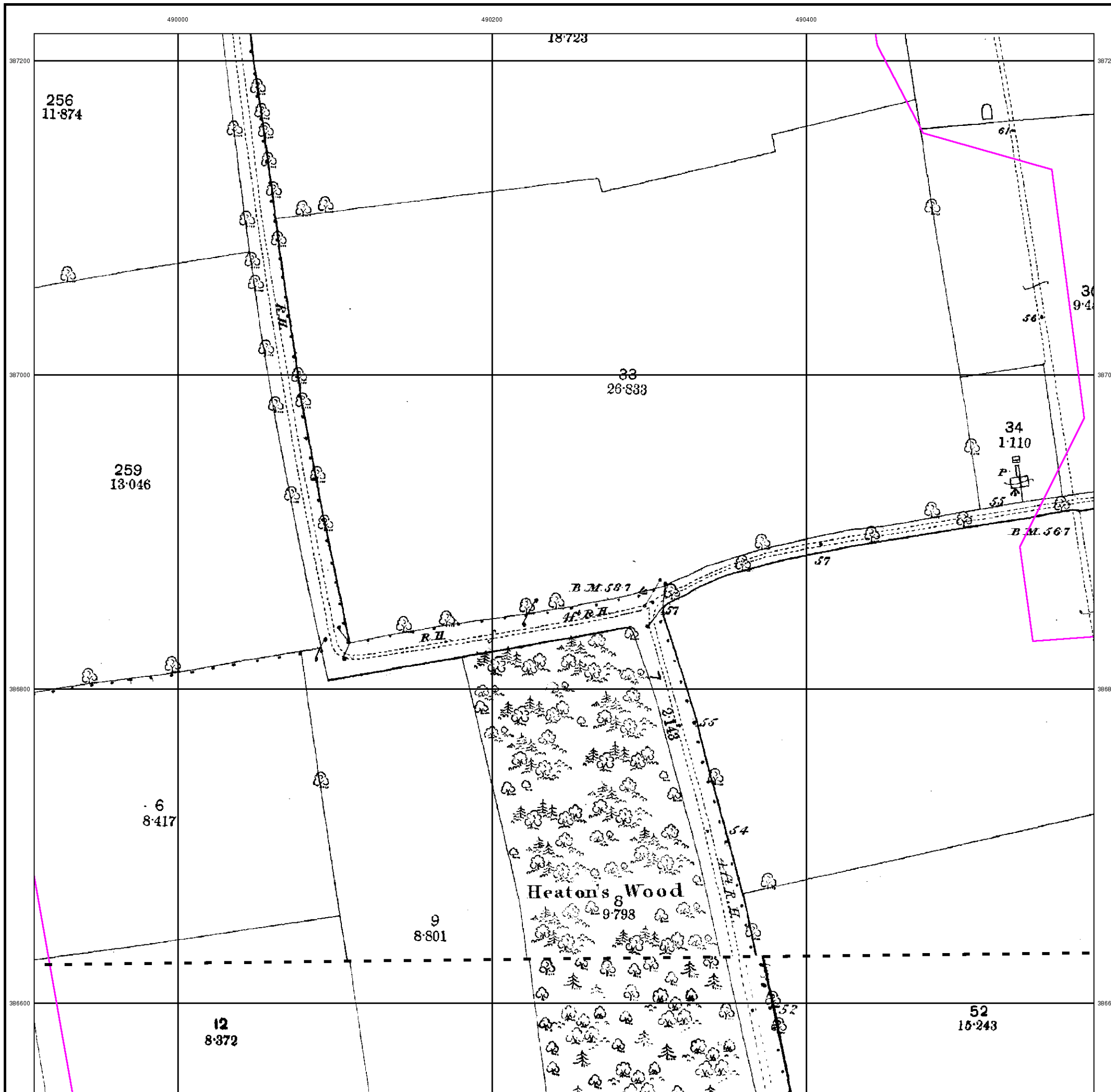

Lincolnshire
Published 1906

Source map scale - 1:2,500

The historical maps shown were reproduced from maps predominantly held at the scale adopted for England, Wales and Scotland in the 1840's. In 1854 the 1:2,500 scale was adopted for mapping urban areas and by 1896 it covered the whole of what were considered to be the cultivated parts of Great Britain. The published date given below is often some years later than the surveyed date. Before 1938, all OS maps were based on the Cassini Projection, with independent surveys of a single county or group of counties, giving rise to significant inaccuracies in outlying areas.

Map Name(s) and Date(s)

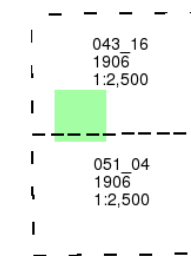

Historical Map - Segment E3

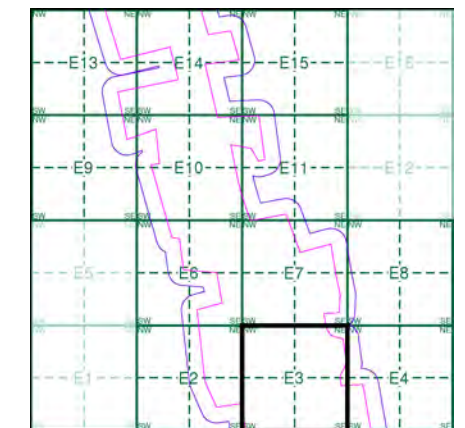

Order Details

Order Number: 297990273_1_1
 Customer Ref: 21-1088.04
 National Grid Reference: 489860, 387850
 Slice: E
 Site Area (Ha): 469.98
 Search Buffer (m): 100

Site Details

Cottam

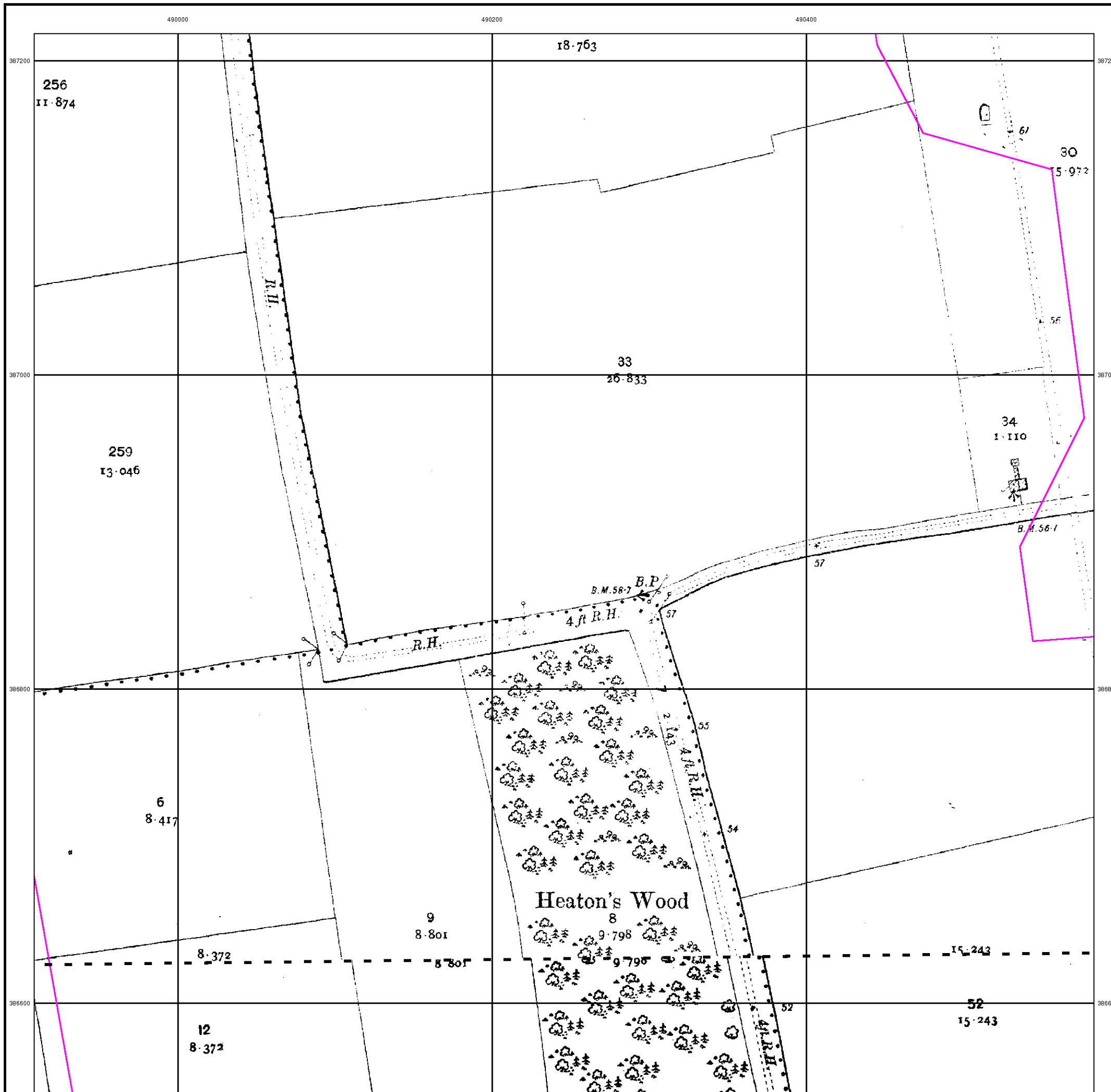

Ordnance Survey Plan
Published 1972 - 1974
Source map scale - 1:2,500

The historical maps shown were reproduced from maps predominantly held at the scale adopted for England, Wales and Scotland in the 1840's. In 1854 the 1:2,500 scale was adopted for mapping urban areas and by 1896 it covered the whole of what were considered to be the cultivated parts of Great Britain. The published date given below is often some years later than the surveyed date. Before 1938, all OS maps were based on the Cassini Projection, with independent surveys of a single county or group of counties, giving rise to significant inaccuracies in outlying areas.

Map Name(s) and Date(s)

SK8987 1973 12,500	SK9087 1974 12,500
SK8986 1972 12,500	SK9086 1974 12,500

Historical Map - Segment E3

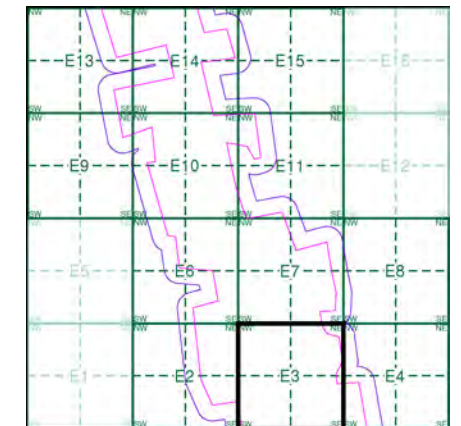

Order Details

Order Number: 297990273_1_1
 Customer Ref: 21-1088.04
 National Grid Reference: 489860, 387850
 Slice: E
 Site Area (Ha): 469.98
 Search Buffer (m): 100

Site Details

Cottam

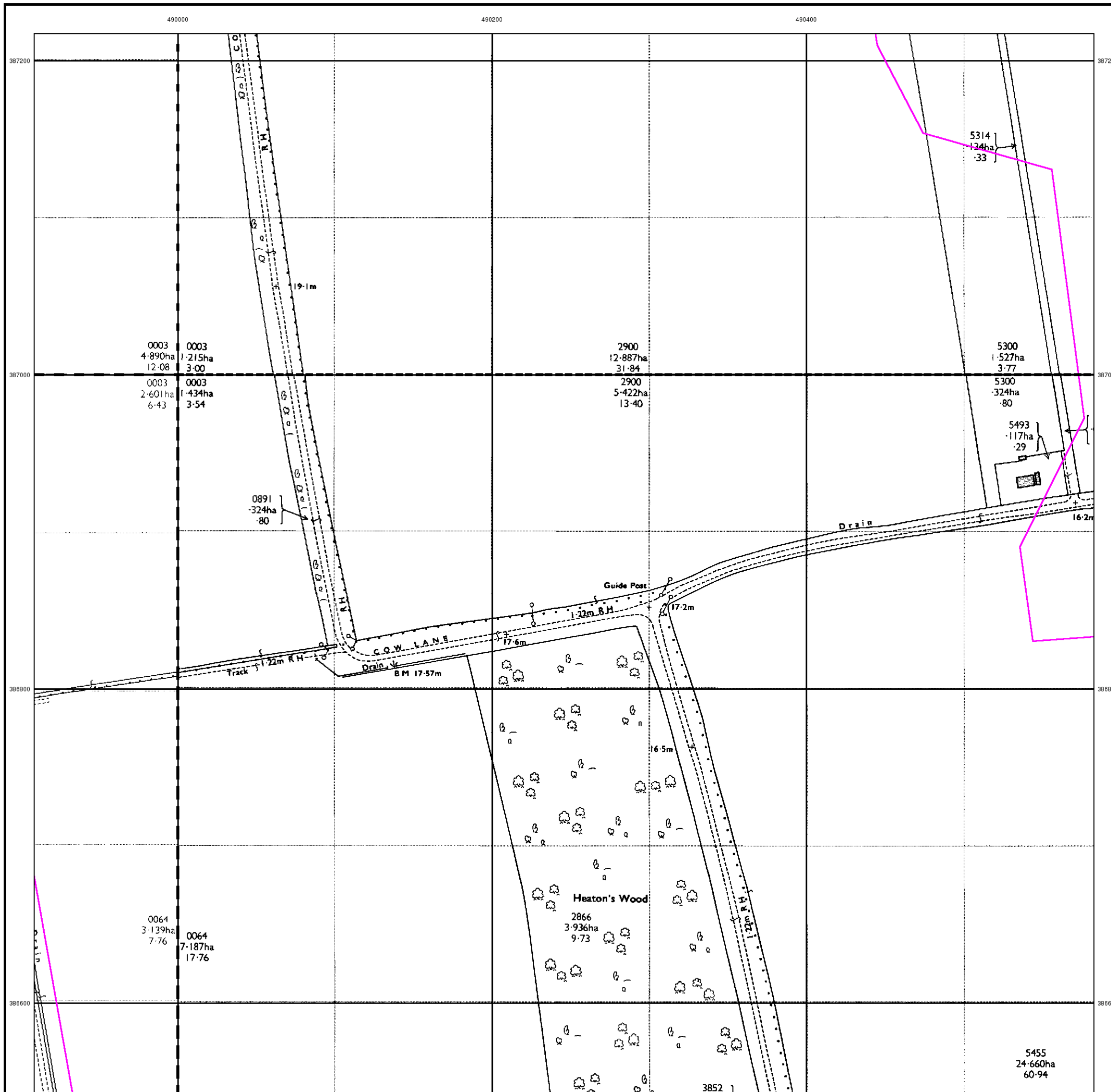

Large-Scale National Grid Data

Published 1994

Source map scale - 1:2,500

'Large Scale National Grid Data' superseded SIM cards (Ordnance Survey's 'Survey of Information on Microfilm') in 1992, and continued to be produced until 1999. These maps were the fore-runners of digital mapping and so provide detailed information on houses and roads, but tend to show less topographic features such as vegetation. These maps were produced at both 1:2,500 and 1:1,250 scales.

Map Name(s) and Date(s)

SK8987 1994 1:2,500	SK9087 1994 1:2,500
SK8986 1994 1:2,500	SK9086 1994 1:2,500

Historical Map - Segment E3

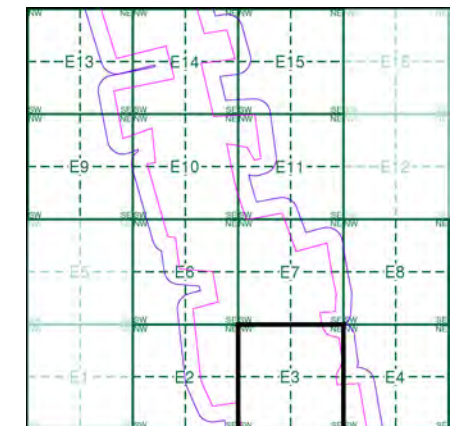

Order Details

Order Number: 297990273_1_1
 Customer Ref: 21-1088.04
 National Grid Reference: 489860, 387850
 Slice: E
 Site Area (Ha): 469.98
 Search Buffer (m): 100

Site Details

Cottam

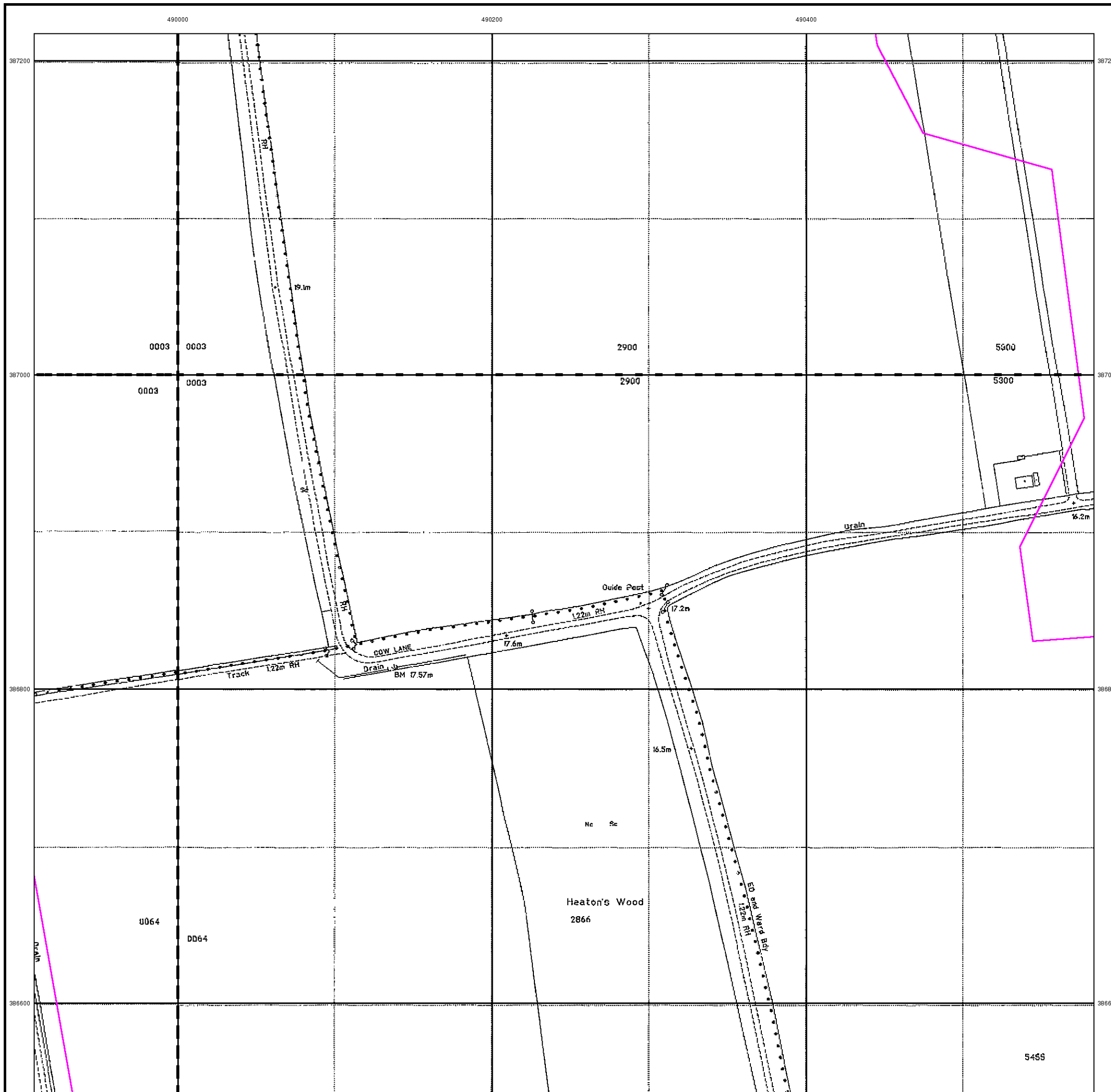

Historical Mapping Legends

Ordnance Survey County Series and Ordnance Survey Plan 1:2,500

Quarry **Gravel Pit** **Sand Pit**
Clay Pit **Shingle** **Refuse Heap**
Sloping Masonry **Flat Rock**
Marsh **Reeds** **Osiers**
Rough Pasture **Furze** **Wood**
Mixed Wood **Brushwood** **Orchard**
Fir **Ford** **Stepping Stones**
Ferry **Waterfall** **Lock**
Trig. Station **Altitude at Trig. Station**
B.M. 325.9 **Bench Mark** **Surface Level**
Arrow denotes flow of water **Antiquities (site of)**
Cutting **Embankment**
Railway crossing Road **Level Crossing** **Road crossing Railway**
Railway crossing River or Canal **Road over single stream** **Road over River or Canal**
County Boundary (Geographical)
County & Civil Parish Boundary
Administrative County & Civil Parish Boundary
County Borough Boundary (England)
County Burgh Boundary (Scotland)
Co. Boro. Bdy.
Co. Burgh Bdy.
BP BS Boundary Post or Stone **P.C.B** Police Call Box
B.R. Bridle Road **P** Pump
E.P Electricity Pylon **S.P** Signal Post
F.B. Foot Bridge **SL** Sluice
F.P. Foot Path **Sp.** Spring
G.P Guide Post or Board **T.C.B** Telephone Call Box
M.S Mile Stone **Tr.** Trough
M.P M.R Mooring Post or Ring **W** Well

Ordnance Survey Plan, Additional SIMs and Supply of Unpublished Survey Information 1:2,500 and 1:1,250

Inactive Quarry, Chalk Pit or Clay Pit **Active Quarry, Chalk Pit or Clay Pit**
Rock **Boulders**
Cliff **Slopes** **Top**
Roofed Building **Glazed Roof Building**
Sloping Masonry **Archway**
Non-Coniferous Tree (surveyed) **Coniferous Tree (surveyed)**
Non-Coniferous Trees (not surveyed) **Coniferous Trees (not surveyed)**
Orchard Tree **Scrub** **Bracken**
Coppice, Osier **Reeds** **Marsh, Saltings**
Rough Grassland **Heath** **Culvert**
Direction of water flow **Bench Mark** **Antiquity (site of)**
Cave Entrance **Triangulation Station** **Electricity Pylon**
Electricity Transmission Line
County Boundary (Geographical)
County & Civil Parish Boundary
Civil Parish Boundary
Admin. County or County Bor. Boundary
London Borough Boundary
Symbol marking point where boundary mereing changes
BH Beer House **P** Pillar, Pole or Post
BP, BS Boundary Post or Stone **PO** Post Office
Cn, C Capstan, Crane **PC** Public Convenience
Chy Chimney **PH** Public House
D Fn Drinking Fountain **Pp** Pump
EI P Electricity Pillar or Post **SB, S Br** Signal Box or Bridge
FAP Fire Alarm Pillar **SP, SL** Signal Post or Light
FB Foot Bridge **Spr** Spring
GP Guide Post **Tk** Tank or Track
H Hydrant or Hydraulic **TCB** Telephone Call Box
LC Level Crossing **TCP** Telephone Call Post
MH Manhole **Tr** Trough
MP Mile Post or Mooring Post **Wr Pt, Wr T** Water Point, Water Tap
MS Mile Stone **W** Well
NTL Normal Tidal Limit **Wd Pp** Wind Pump

Large-Scale National Grid Data 1:2,500 and 1:1,250

Cliff **Slopes** **Top**
Rock **Rock (scattered)**
Boulders **Boulders (scattered)**
Positioned Boulder **Scree**
Non-Coniferous Tree (surveyed) **Coniferous Tree (surveyed)**
Non-Coniferous Trees (not surveyed) **Coniferous Trees (not surveyed)**
Orchard Tree **Scrub** **Bracken**
Coppice, Osier **Reeds** **Marsh, Saltings**
Rough Grassland **Heath** **Culvert**
Direction of water flow **Triangulation Station** **Antiquity (site of)**
Electricity Transmission Line **Electricity Pylon**
BM 231.60m Bench Mark **Buildings with Building Seed**
Roofed Building **Glazed Roof Building**
Civil parish/community boundary
District boundary
County boundary
Boundary post/stone
Boundary mereing symbol (note: these always appear in opposed pairs or groups of three)
Bks Barracks **P** Pillar, Pole or Post
Bty Battery **PO** Post Office
Cemy Cemetery **PC** Public Convenience
Chy Chimney **Pp** Pump
Cis Cistern **Ppg Sta** Pumping Station
Dismtd Rly Dismantled Railway **PW** Place of Worship
EI Gen Sta Electricity Generating Station **Sewage Ppg Sta** Sewage Pumping Station
EI P Electricity Pole, Pillar **SB, S Br** Signal Box or Bridge
EI Sub Sta Electricity Sub Station **SP, SL** Signal Post or Light
FB Filter Bed **Spr** Spring
Fn / D Fn Fountain / Drinking Ftn. **Tk** Tank or Track
Gas Gov Gas Valve Compound **Tr** Trough
GVC Gas Governor **Wd Pp** Wind Pump
GP Guide Post **Wr Pt, Wr T** Water Point, Water Tap
MH Manhole **Wks** Works (building or area)
MP, MS Mile Post or Mile Stone **W** Well



Historical Mapping & Photography included:

Mapping Type	Scale	Date	Pg
Lincolnshire	1:2,500	1886	2
Lincolnshire	1:2,500	1906	3
Ordnance Survey Plan	1:2,500	1974	4
Large-Scale National Grid Data	1:2,500	1994	5

Historical Map - Segment E4

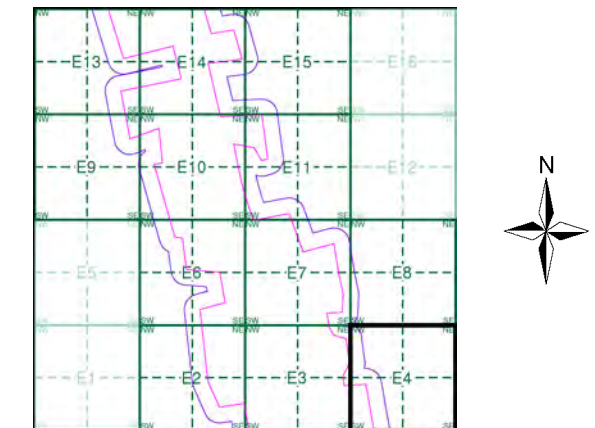

Order Details

Order Number: 297990273_1_1
 Customer Ref: 21-1088.04
 National Grid Reference: 489860, 387850
 Slice: E
 Site Area (Ha): 469.98
 Search Buffer (m): 100

Site Details

Cottam



Tel:
Fax:
Web:

Lincolnshire

Published 1886

Source map scale - 1:2,500

The historical maps shown were reproduced from maps predominantly held at the scale adopted for England, Wales and Scotland in the 1840's. In 1854 the 1:2,500 scale was adopted for mapping urban areas and by 1896 it covered the whole of what were considered to be the cultivated parts of Great Britain. The published date given below is often some years later than the surveyed date. Before 1938, all OS maps were based on the Cassini Projection, with independent surveys of a single county or group of counties, giving rise to significant inaccuracies in outlying areas.

Map Name(s) and Date(s)

043_16
1886
1:2,500
051_04
1886
1:2,500

Historical Map - Segment E4

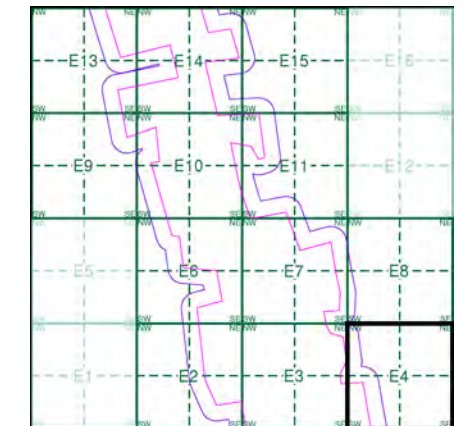

Order Details

Order Number: 297990273_1_1
 Customer Ref: 21-1088.04
 National Grid Reference: 489860, 387850
 Slice: E
 Site Area (Ha): 469.98
 Search Buffer (m): 100

Site Details

Cottam

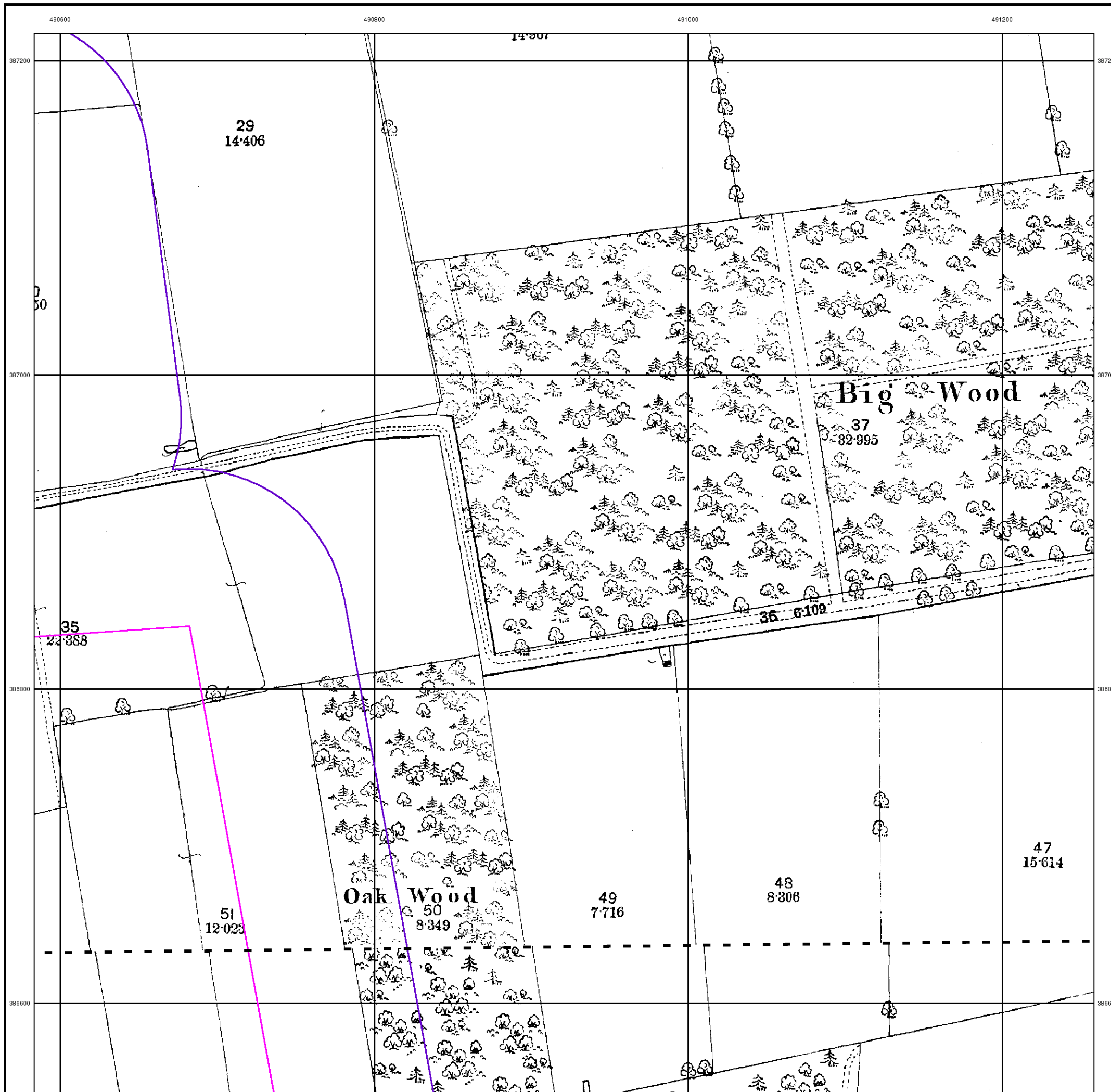

Lincolnshire

Published 1906

Source map scale - 1:2,500

The historical maps shown were reproduced from maps predominantly held at the scale adopted for England, Wales and Scotland in the 1840's. In 1854 the 1:2,500 scale was adopted for mapping urban areas and by 1896 it covered the whole of what were considered to be the cultivated parts of Great Britain. The published date given below is often some years later than the surveyed date. Before 1938, all OS maps were based on the Cassini Projection, with independent surveys of a single county or group of counties, giving rise to significant inaccuracies in outlying areas.

Map Name(s) and Date(s)

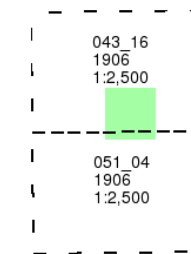

Historical Map - Segment E4

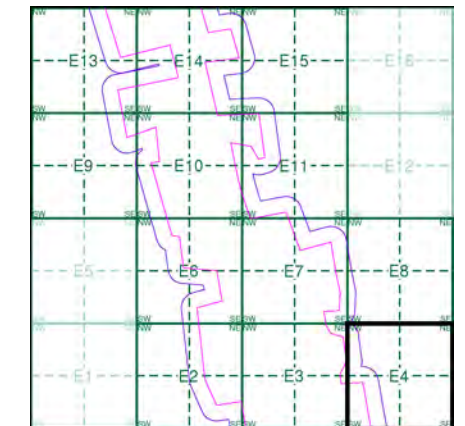

Order Details

Order Number: 297990273_1_1
 Customer Ref: 21-1088.04
 National Grid Reference: 489860, 387850
 Slice: E
 Site Area (Ha): 469.98
 Search Buffer (m): 100

Site Details

Cottam

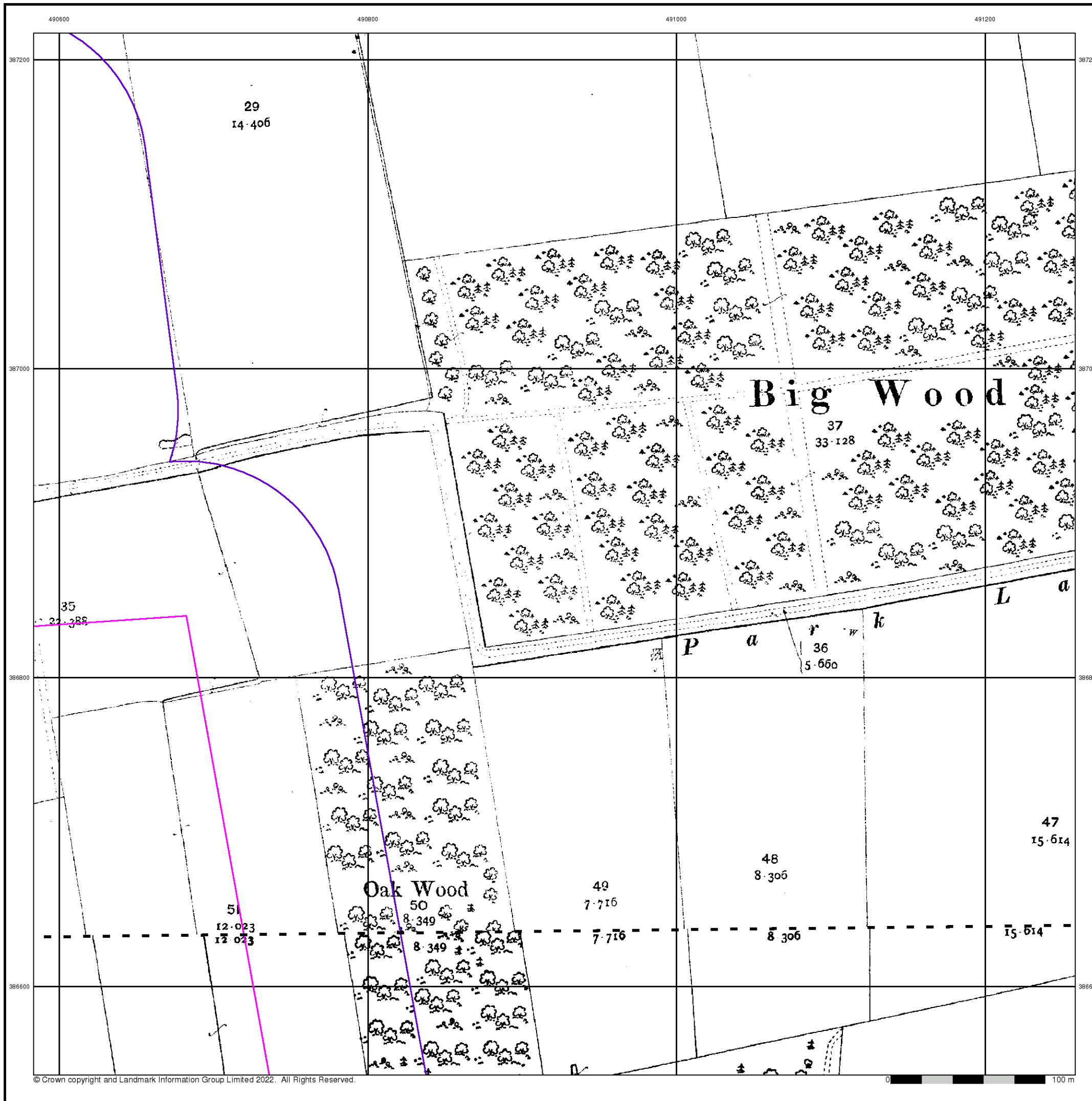

Ordnance Survey Plan

Published 1974

Source map scale - 1:2,500

The historical maps shown were reproduced from maps predominantly held at the scale adopted for England, Wales and Scotland in the 1840's. In 1854 the 1:2,500 scale was adopted for mapping urban areas and by 1896 it covered the whole of what were considered to be the cultivated parts of Great Britain. The published date given below is often some years later than the surveyed date. Before 1938, all OS maps were based on the Cassini Projection, with independent surveys of a single county or group of counties, giving rise to significant inaccuracies in outlying areas.

Map Name(s) and Date(s)

SK9087 1974 1:2,500	SK9187 1974 1:2,500
SK9086 1974 1:2,500	SK9186 1974 1:2,500

Historical Map - Segment E4

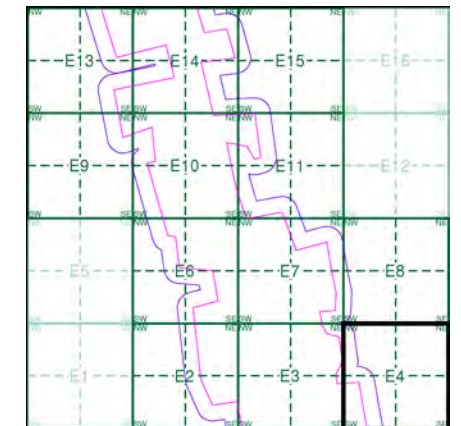

Order Details

Order Number: 297990273_1_1
 Customer Ref: 21-1088.04
 National Grid Reference: 489860, 387850
 Slice: E
 Site Area (Ha): 469.98
 Search Buffer (m): 100

Site Details

Cottam

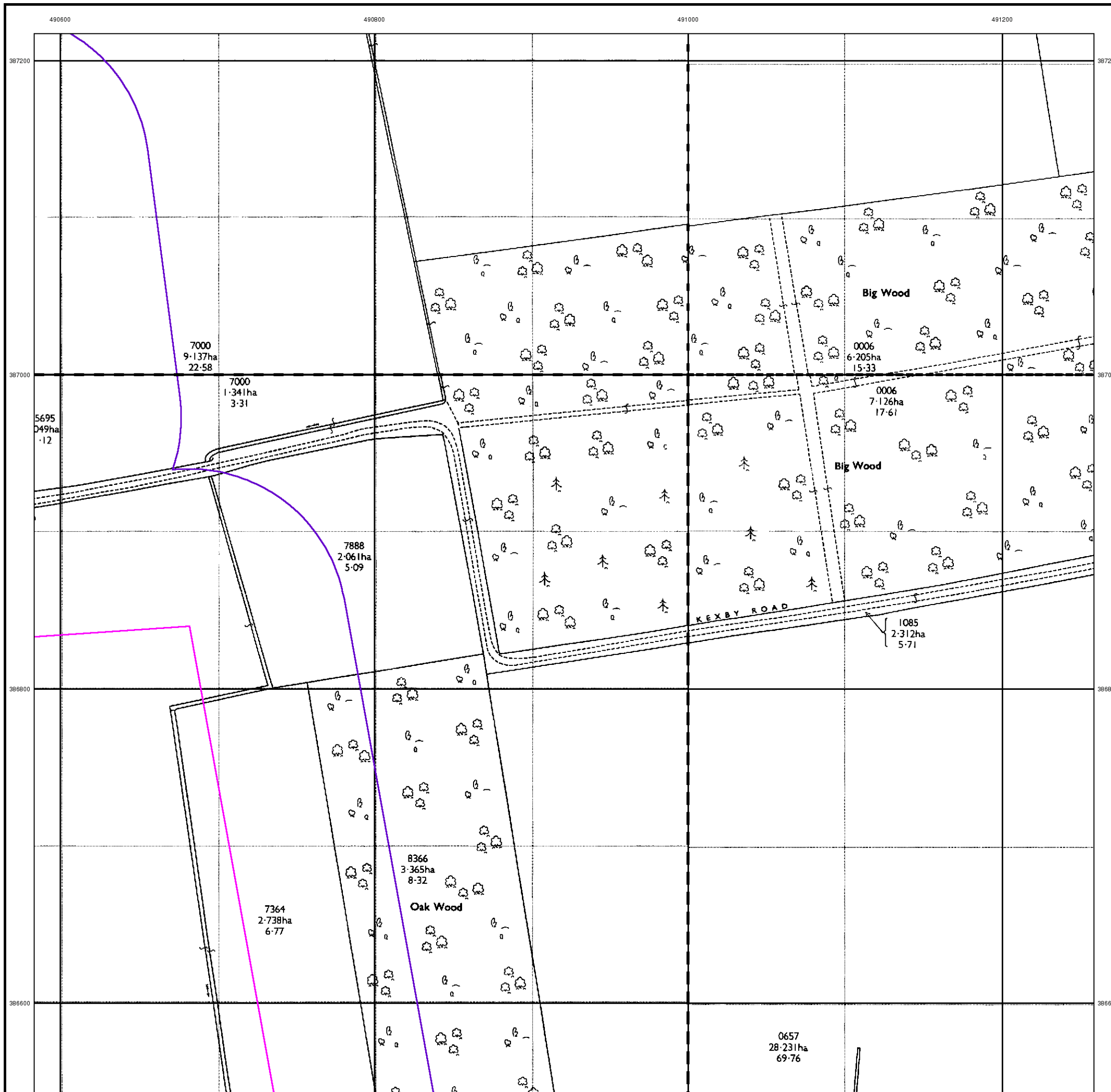

Large-Scale National Grid Data

Published 1994

Source map scale - 1:2,500

'Large Scale National Grid Data' superseded SIM cards (Ordnance Survey's 'Survey of Information on Microfilm') in 1992, and continued to be produced until 1999. These maps were the fore-runners of digital mapping and so provide detailed information on houses and roads, but tend to show less topographic features such as vegetation. These maps were produced at both 1:2,500 and 1:1,250 scales.

Map Name(s) and Date(s)

SK9087 1994 1:2,500	SK9187 1994 1:2,500
SK9086 1994 1:2,500	SK9186 1994 1:2,500

Historical Map - Segment E4

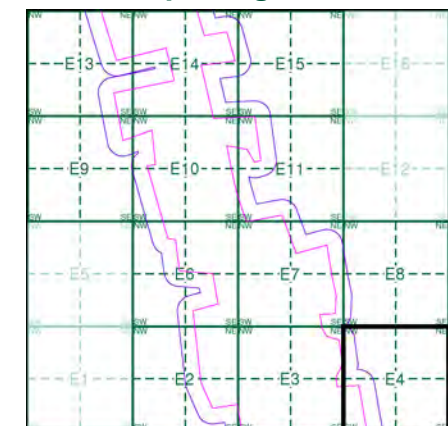

Order Details

Order Number: 297990273_1_1
 Customer Ref: 21-1088.04
 National Grid Reference: 489860, 387850
 Slice: E
 Site Area (Ha): 469.98
 Search Buffer (m): 100

Site Details

Cottam

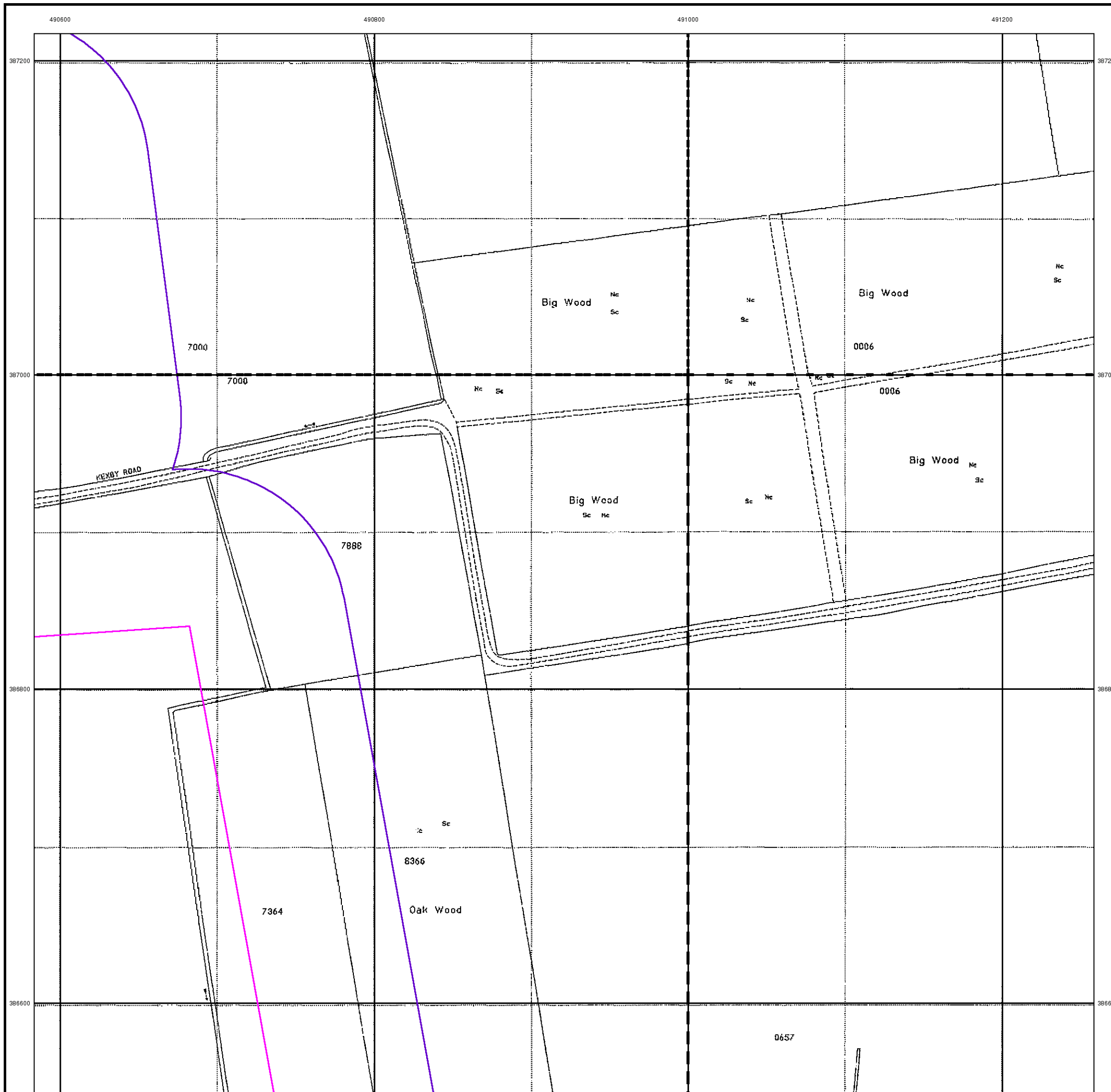

Historical Mapping Legends

Ordnance Survey County Series and Ordnance Survey Plan 1:2,500

Quarry **Gravel Pit** **Sand Pit**
Clay Pit **Shingle** **Refuse Heap**
Sloping Masonry **Flat Rock**
Marsh **Reeds** **Osiers**
Rough Pasture **Furze** **Wood**
Mixed Wood **Brushwood** **Orchard**
Fir **Ford** **Stepping Stones**
Ferry **Waterfall** **Lock**
Trig. Station **Altitude at Trig. Station**
B.M. 325.9 **Bench Mark** **Surface Level**
Arrow denotes flow of water **Antiquities (site of)**
Cutting **Embankment**
Railway crossing Road **Level Crossing** **Road crossing Railway**
Railway crossing River or Canal **Road over single stream** **Road over River or Canal**
County Boundary (Geographical)
County & Civil Parish Boundary
Administrative County & Civil Parish Boundary
County Borough Boundary (England)
Co. Boro. Bdy.
County Burgh Boundary (Scotland)
Co. Burgh Bdy.
BP BS Boundary Post or Stone **P.C.B** Police Call Box
B.R. Bridle Road **P** Pump
E.P Electricity Pylon **S.P** Signal Post
F.B. Foot Bridge **SL** Sluice
F.P. Foot Path **Sp.** Spring
G.P Guide Post or Board **T.C.B** Telephone Call Box
M.S Mile Stone **Tr.** Trough
M.P M.R Mooring Post or Ring **W** Well

Ordnance Survey Plan, Additional SIMs and Supply of Unpublished Survey Information 1:2,500 and 1:1,250

Inactive Quarry, Chalk Pit or Clay Pit **Active Quarry, Chalk Pit or Clay Pit**
Rock **Boulders**
Cliff **Slopes** **Top**
Roofed Building **Glazed Roof Building**
Sloping Masonry **Archway**
Non-Coniferous Tree (surveyed) **Coniferous Tree (surveyed)**
Non-Coniferous Trees (not surveyed) **Coniferous Trees (not surveyed)**
Orchard Tree **Scrub** **Bracken**
Coppice, Osier **Reeds** **Marsh, Saltings**
Rough Grassland **Heath** **Culvert**
Direction of water flow **Bench Mark** **Antiquity (site of)**
Cave Entrance **Triangulation Station** **Electricity Pylon**
Electricity Transmission Line
County Boundary (Geographical)
County & Civil Parish Boundary
Civil Parish Boundary
Admin. County or County Bor. Boundary
London Borough Boundary
Symbol marking point where boundary mereing changes
BH Beer House **P** Pillar, Pole or Post
BP, BS Boundary Post or Stone **PO** Post Office
Cn, C Capstan, Crane **PC** Public Convenience
Chy Chimney **PH** Public House
D Fn Drinking Fountain **Pp** Pump
EI P Electricity Pillar or Post **SB, S Br** Signal Box or Bridge
FAP Fire Alarm Pillar **SP, SL** Signal Post or Light
FB Foot Bridge **Spr** Spring
GP Guide Post **Tk** Tank or Track
H Hydrant or Hydraulic **TCB** Telephone Call Box
LC Level Crossing **TCP** Telephone Call Post
MH Manhole **Tr** Trough
MP Mile Post or Mooring Post **Wr Pt, Wr T** Water Point, Water Tap
MS Mile Stone **W** Well
NTL Normal Tidal Limit **Wd Pp** Wind Pump

Large-Scale National Grid Data 1:2,500 and 1:1,250

Cliff **Slopes** **Top**
Rock **Rock (scattered)**
Boulders **Boulders (scattered)**
Positioned Boulder **Scree**
Non-Coniferous Tree (surveyed) **Coniferous Tree (surveyed)**
Non-Coniferous Trees (not surveyed) **Coniferous Trees (not surveyed)**
Orchard Tree **Scrub** **Bracken**
Coppice, Osier **Reeds** **Marsh, Saltings**
Rough Grassland **Heath** **Culvert**
Direction of water flow **Triangulation Station** **Antiquity (site of)**
Electricity Transmission Line **Electricity Pylon**
B.M. 231.60m Bench Mark **Buildings with Building Seed**
Roofed Building **Glazed Roof Building**
Civil parish/community boundary
District boundary
County boundary
Boundary post/stone
Boundary mereing symbol (note: these always appear in opposed pairs or groups of three)
Bks Barracks **P** Pillar, Pole or Post
Bty Battery **PO** Post Office
Cemy Cemetery **PC** Public Convenience
Chy Chimney **Pp** Pump
Cis Cistern **Ppg Sta** Pumping Station
Dismtd Rly Dismantled Railway **PW** Place of Worship
EI Gen Sta Electricity Generating Station **Sewage Ppg Sta** Sewage Pumping Station
EI P Electricity Pole, Pillar **SB, S Br** Signal Box or Bridge
EI Sub Sta Electricity Sub Station **SP, SL** Signal Post or Light
FB Filter Bed **Spr** Spring
Fn / D Fn Fountain / Drinking Ftn. **Tk** Tank or Track
Gas Gov Gas Valve Compound **Tr** Trough
GVC Gas Governor **Wd Pp** Wind Pump
GP Guide Post **Wr Pt, Wr T** Water Point, Water Tap
MH Manhole **Wks** Works (building or area)
MP, MS Mile Post or Mile Stone **W** Well



Historical Mapping & Photography included:

Mapping Type	Scale	Date	Pg
Lincolnshire	1:2,500	1886	2
Lincolnshire	1:2,500	1906	3
Ordnance Survey Plan	1:2,500	1973	4
Large-Scale National Grid Data	1:2,500	1994	5

Historical Map - Segment E6

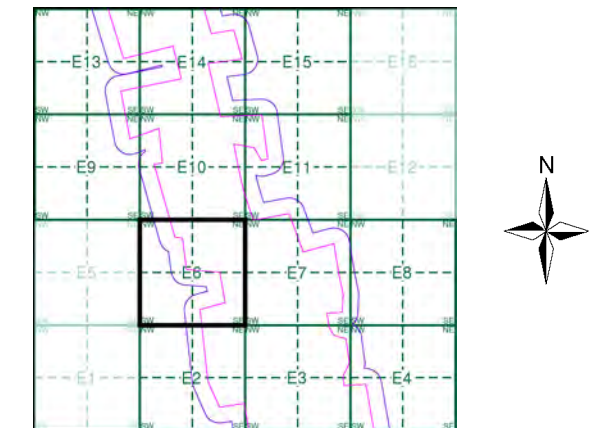

Order Details

Order Number: 297990273_1_1
 Customer Ref: 21-1088.04
 National Grid Reference: 489860, 387850
 Slice: E
 Site Area (Ha): 469.98
 Search Buffer (m): 100

Site Details

Cottam



Tel:
Fax:
Web:

Lincolnshire
Published 1886

Source map scale - 1:2,500

The historical maps shown were reproduced from maps predominantly held at the scale adopted for England, Wales and Scotland in the 1840's. In 1854 the 1:2,500 scale was adopted for mapping urban areas and by 1896 it covered the whole of what were considered to be the cultivated parts of Great Britain. The published date given below is often some years later than the surveyed date. Before 1938, all OS maps were based on the Cassini Projection, with independent surveys of a single county or group of counties, giving rise to significant inaccuracies in outlying areas.

Map Name(s) and Date(s)

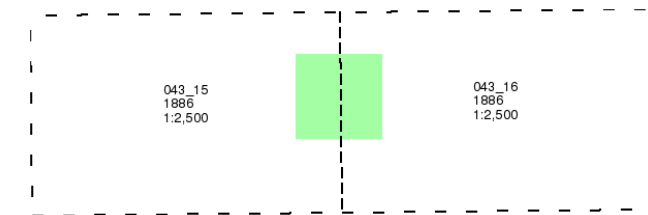

Historical Map - Segment E6

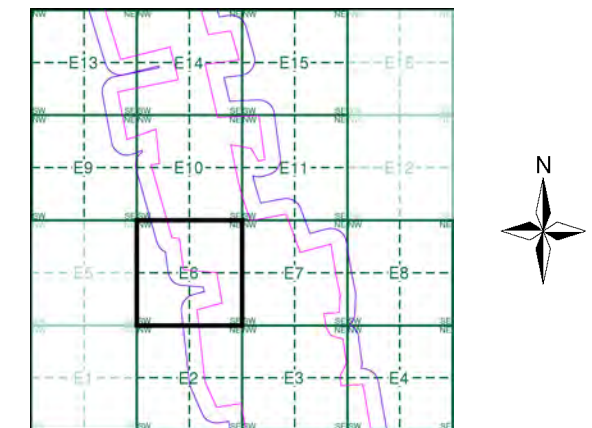

Order Details

Order Number: 297990273_1_1
 Customer Ref: 21-1088.04
 National Grid Reference: 489860, 387850
 Slice: E
 Site Area (Ha): 469.98
 Search Buffer (m): 100

Site Details

Cottam

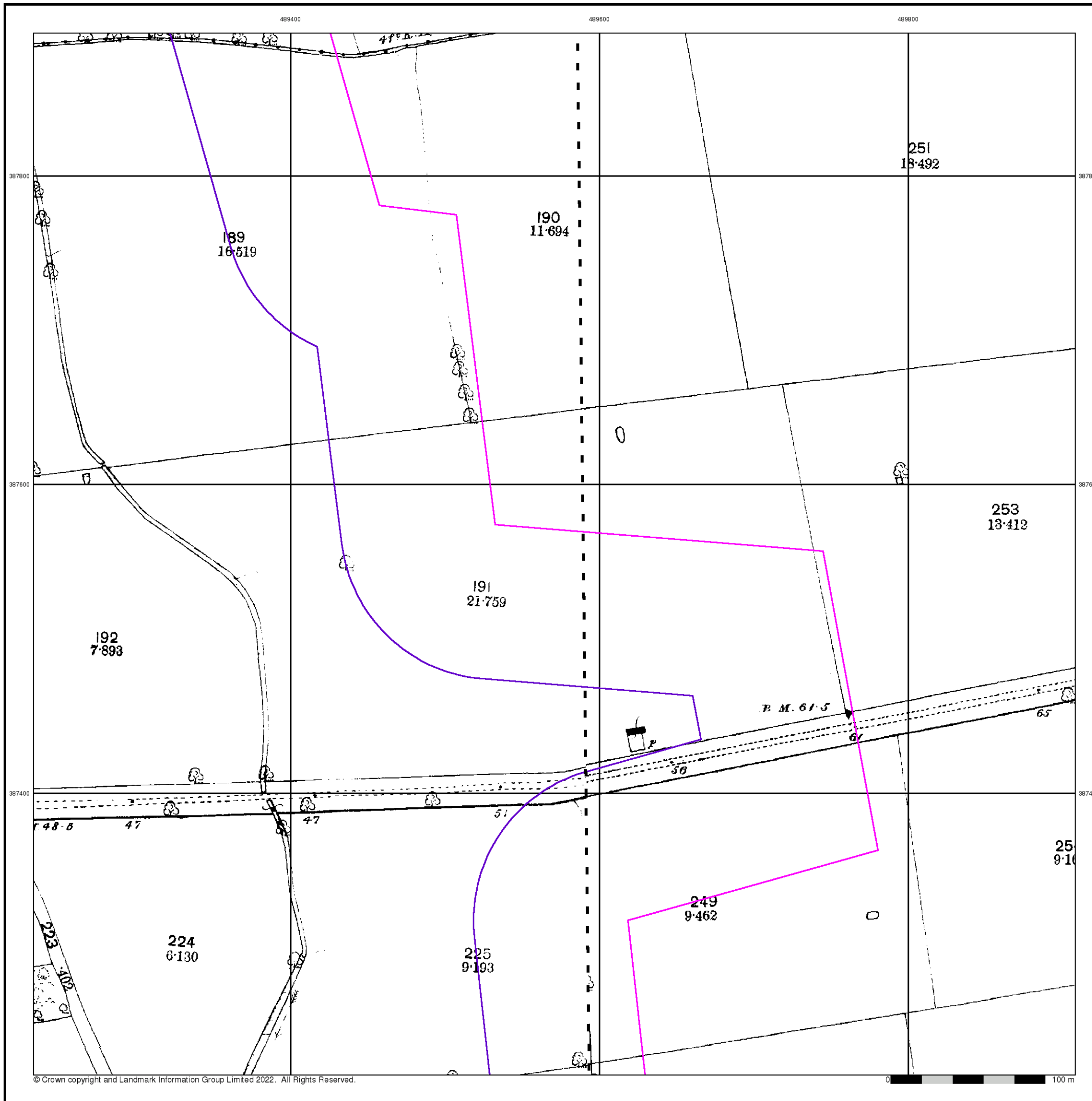

Lincolnshire
Published 1906

Source map scale - 1:2,500

The historical maps shown were reproduced from maps predominantly held at the scale adopted for England, Wales and Scotland in the 1840's. In 1854 the 1:2,500 scale was adopted for mapping urban areas and by 1896 it covered the whole of what were considered to be the cultivated parts of Great Britain. The published date given below is often some years later than the surveyed date. Before 1938, all OS maps were based on the Cassini Projection, with independent surveys of a single county or group of counties, giving rise to significant inaccuracies in outlying areas.

Map Name(s) and Date(s)

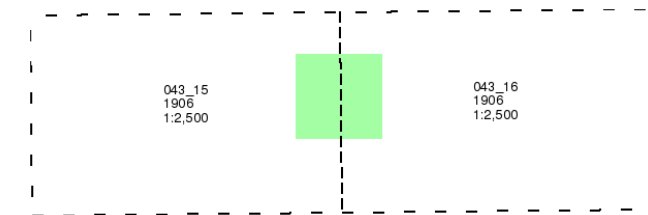

Historical Map - Segment E6

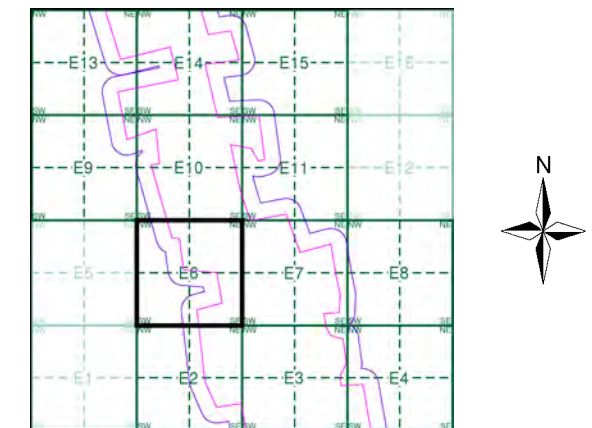

Order Details

Order Number: 297990273_1_1
 Customer Ref: 21-1088.04
 National Grid Reference: 489860, 387850
 Slice: E
 Site Area (Ha): 469.98
 Search Buffer (m): 100

Site Details

Cottam

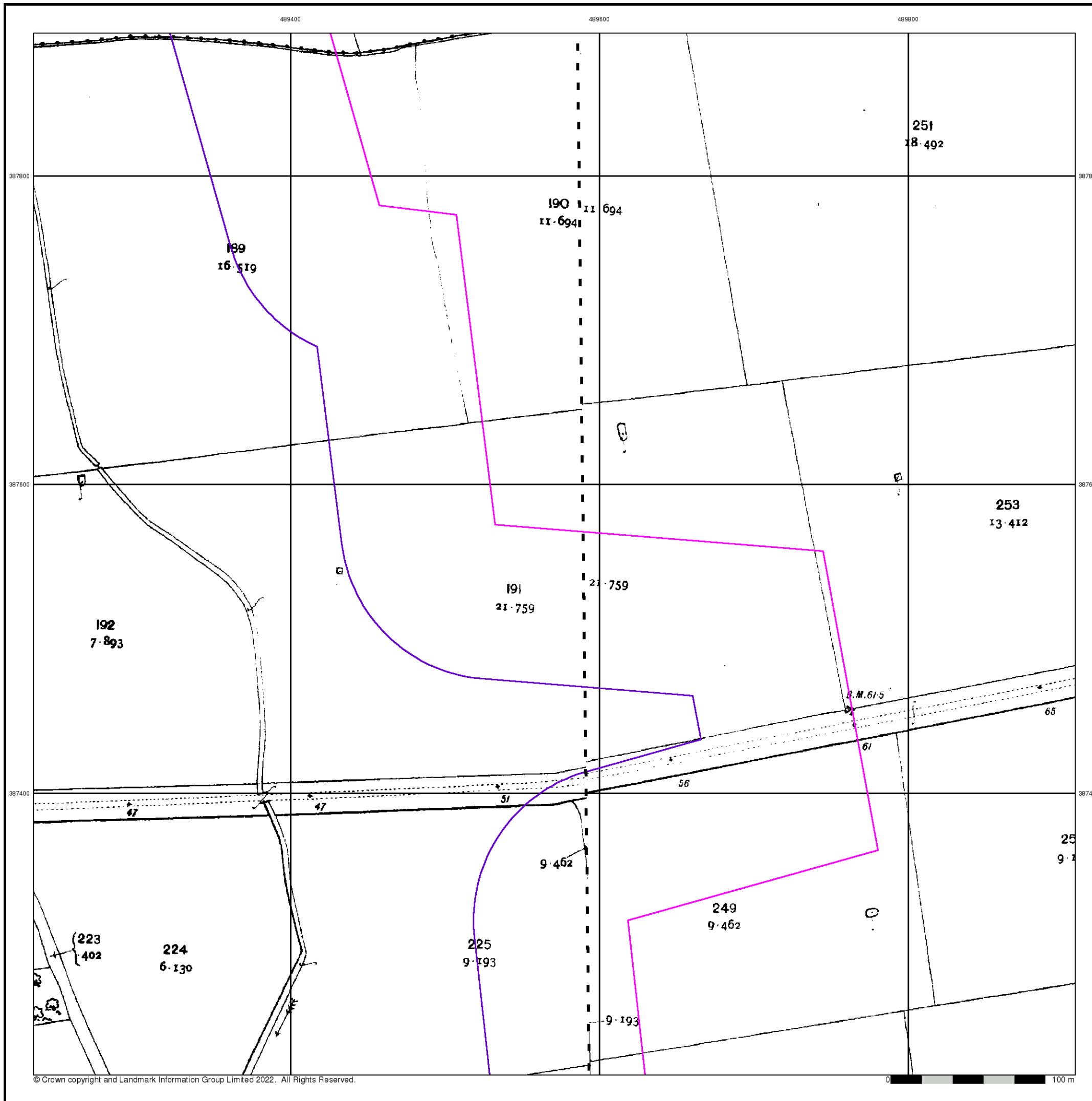

Ordnance Survey Plan

Published 1973

Source map scale - 1:2,500

The historical maps shown were reproduced from maps predominantly held at the scale adopted for England, Wales and Scotland in the 1840's. In 1854 the 1:2,500 scale was adopted for mapping urban areas and by 1896 it covered the whole of what were considered to be the cultivated parts of Great Britain. The published date given below is often some years later than the surveyed date. Before 1938, all OS maps were based on the Cassini Projection, with independent surveys of a single county or group of counties, giving rise to significant inaccuracies in outlying areas.

Map Name(s) and Date(s)

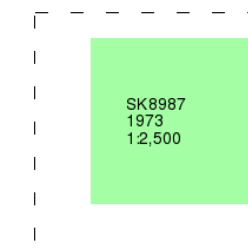

Historical Map - Segment E6

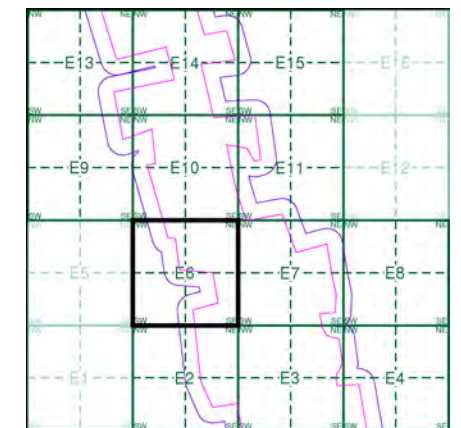

Order Details

Order Number: 297990273_1_1
 Customer Ref: 21-1088.04
 National Grid Reference: 489860, 387850
 Slice: E
 Site Area (Ha): 469.98
 Search Buffer (m): 100

Site Details

Cottam

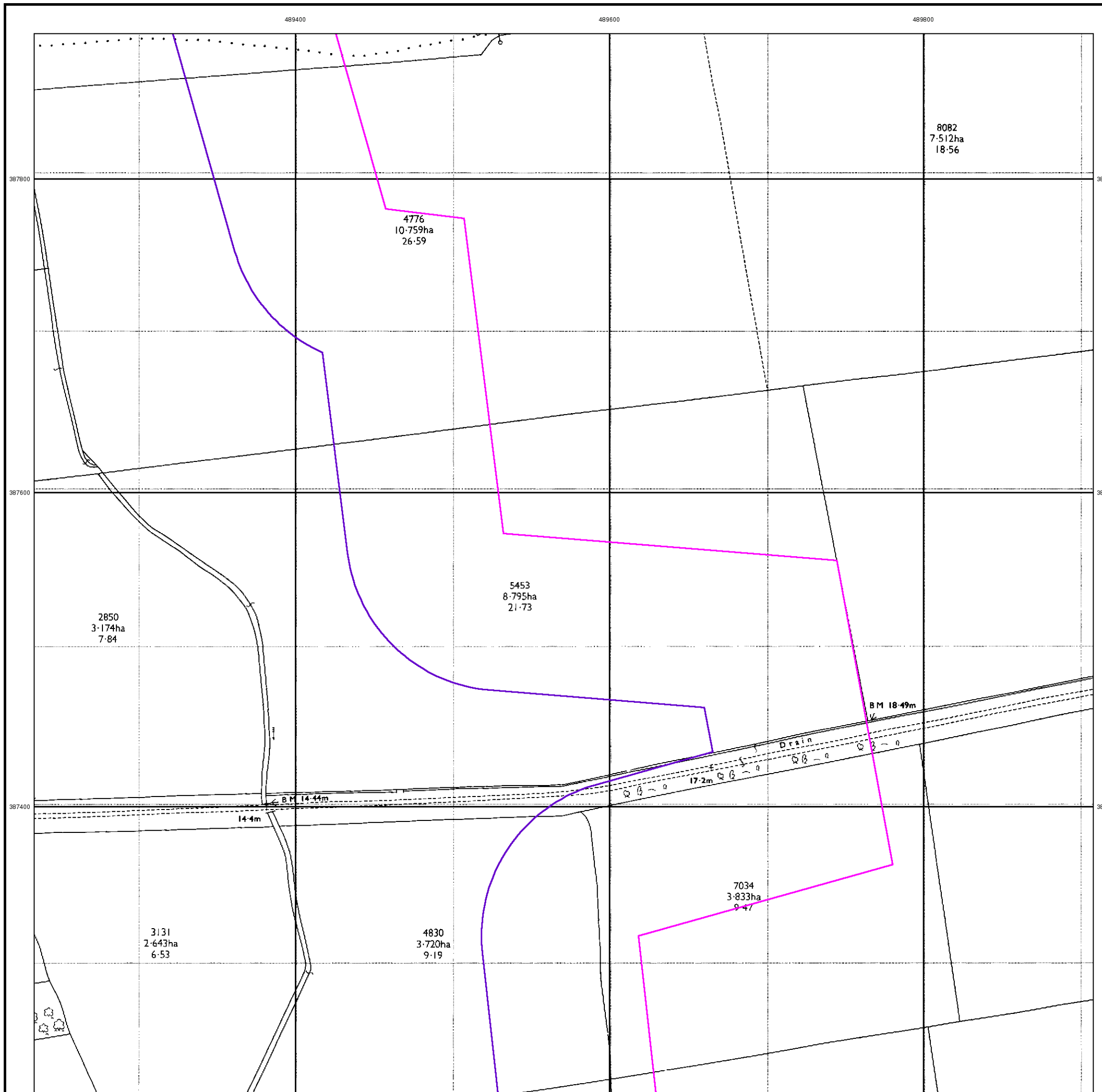

Large-Scale National Grid Data

Published 1994

Source map scale - 1:2,500

'Large Scale National Grid Data' superseded SIM cards (Ordnance Survey's 'Survey of Information on Microfilm') in 1992, and continued to be produced until 1999. These maps were the fore-runners of digital mapping and so provide detailed information on houses and roads, but tend to show less topographic features such as vegetation. These maps were produced at both 1:2,500 and 1:1,250 scales.

Map Name(s) and Date(s)

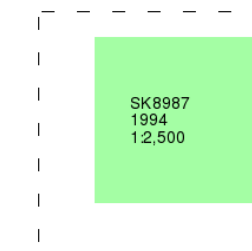

Historical Map - Segment E6

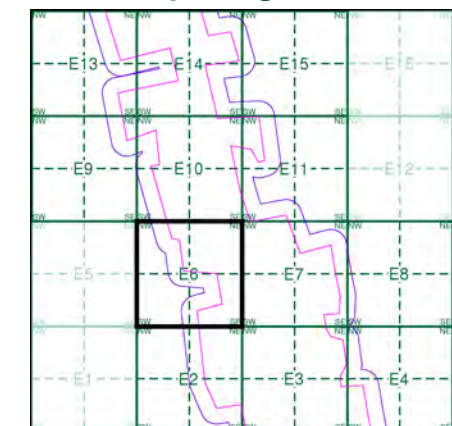

Order Details

Order Number: 297990273_1_1
 Customer Ref: 21-1088.04
 National Grid Reference: 489860, 387850
 Slice: E
 Site Area (Ha): 469.98
 Search Buffer (m): 100

Site Details

Cottam

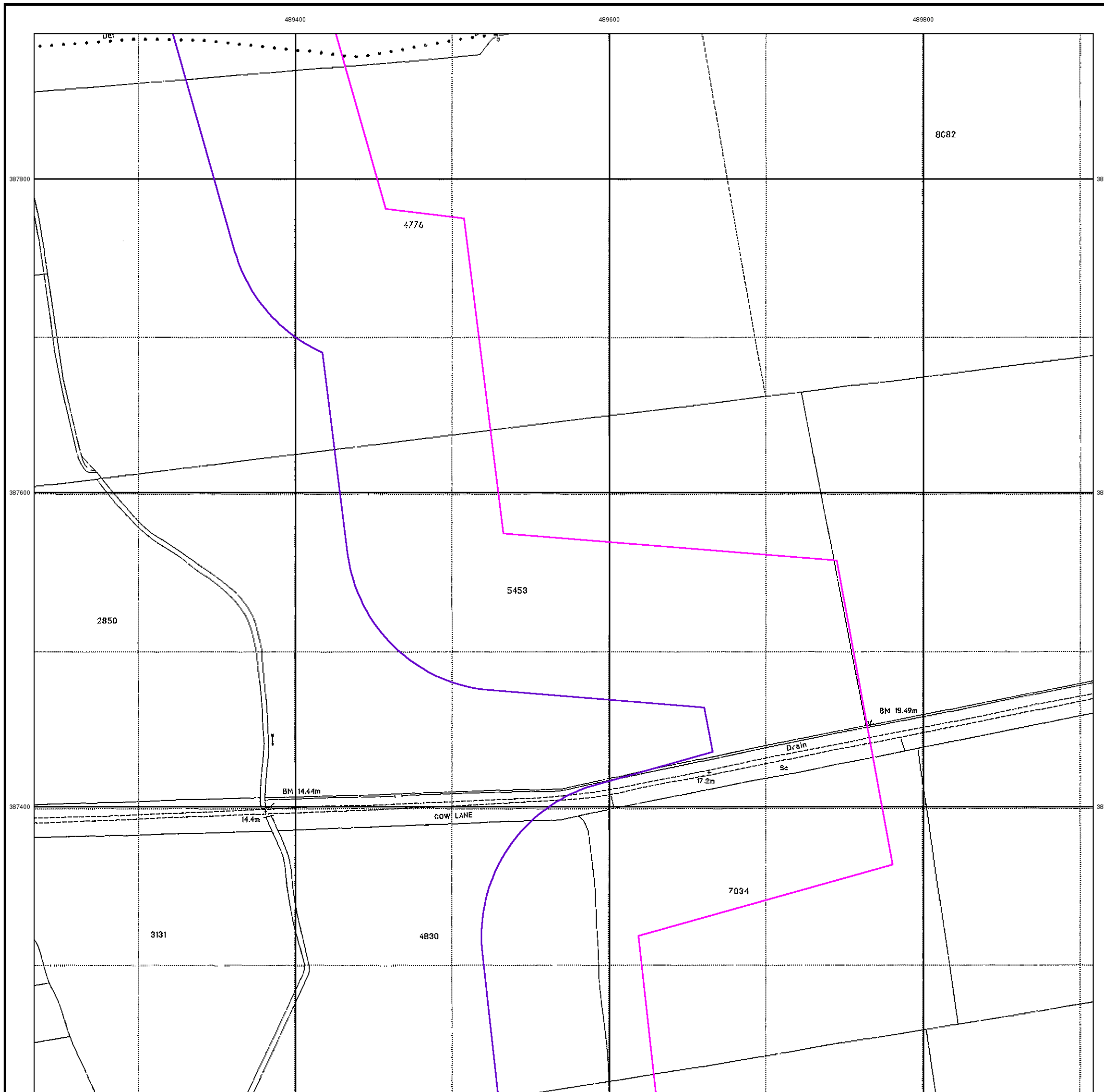

Historical Mapping Legends

Ordnance Survey County Series and Ordnance Survey Plan 1:2,500

Quarry **Gravel Pit** **Sand Pit**
Clay Pit **Shingle** **Refuse Heap**
Sloping Masonry **Flat Rock**
Marsh **Reeds** **Osiers**
Rough Pasture **Furze** **Wood**
Mixed Wood **Brushwood** **Orchard**
Fir **Ford** **Stepping Stones**
Ferry **Waterfall** **Lock**
Trig. Station **Altitude at Trig. Station**
B.M. 325.9 **Bench Mark** **Surface Level**
Arrow denotes flow of water **Antiquities (site of)**
Cutting **Embankment**
Railway crossing Road **Level Crossing** **Road crossing Railway**
Railway crossing River or Canal **Road over single stream** **Road over River or Canal**
County Boundary (Geographical)
County & Civil Parish Boundary
Administrative County & Civil Parish Boundary
County Borough Boundary (England)
Co. Boro. Bdy.
County Burgh Boundary (Scotland)
Co. Burgh Bdy.
BP BS Boundary Post or Stone **P.C.B** Police Call Box
B.R. Bridle Road **P** Pump
E.P Electricity Pylon **S.P** Signal Post
F.B. Foot Bridge **SL** Sluice
F.P. Foot Path **Sp.** Spring
G.P Guide Post or Board **T.C.B** Telephone Call Box
M.S Mile Stone **Tr.** Trough
M.P M.R Mooring Post or Ring **W** Well

Ordnance Survey Plan, Additional SIMs and Supply of Unpublished Survey Information 1:2,500 and 1:1,250

Inactive Quarry, Chalk Pit or Clay Pit **Active Quarry, Chalk Pit or Clay Pit**
Rock **Boulders**
Cliff **Slopes** **Top**
Roofed Building **Glazed Roof Building**
Sloping Masonry **Archway**
Non-Coniferous Tree (surveyed) **Coniferous Tree (surveyed)**
Non-Coniferous Trees (not surveyed) **Coniferous Trees (not surveyed)**
Orchard Tree **Scrub** **Bracken**
Coppice, Osier **Reeds** **Marsh, Saltings**
Rough Grassland **Heath** **Culvert**
Direction of water flow **Bench Mark** **Antiquity (site of)**
Cave Entrance **Triangulation Station** **Electricity Pylon**
Electricity Transmission Line
County Boundary (Geographical)
County & Civil Parish Boundary
Civil Parish Boundary
Admin. County or County Bor. Boundary
London Borough Boundary
Symbol marking point where boundary mereing changes
BH Beer House **P** Pillar, Pole or Post
BP, BS Boundary Post or Stone **PO** Post Office
Cn, C Capstan, Crane **PC** Public Convenience
Chy Chimney **PH** Public House
D Fn Drinking Fountain **Pp** Pump
EI P Electricity Pillar or Post **SB, S Br** Signal Box or Bridge
FAP Fire Alarm Pillar **SP, SL** Signal Post or Light
FB Foot Bridge **Spr** Spring
GP Guide Post **Tk** Tank or Track
H Hydrant or Hydraulic **TCB** Telephone Call Box
LC Level Crossing **TCP** Telephone Call Post
MH Manhole **Tr** Trough
MP Mile Post or Mooring Post **Wr Pt, Wr T** Water Point, Water Tap
MS Mile Stone **W** Well
NTL Normal Tidal Limit **Wd Pp** Wind Pump

Large-Scale National Grid Data 1:2,500 and 1:1,250

Cliff **Slopes** **Top**
Rock **Rock (scattered)**
Boulders **Boulders (scattered)**
Positioned Boulder **Scree**
Non-Coniferous Tree (surveyed) **Coniferous Tree (surveyed)**
Non-Coniferous Trees (not surveyed) **Coniferous Trees (not surveyed)**
Orchard Tree **Scrub** **Bracken**
Coppice, Osier **Reeds** **Marsh, Saltings**
Rough Grassland **Heath** **Culvert**
Direction of water flow **Triangulation Station** **Antiquity (site of)**
Electricity Transmission Line **Electricity Pylon**
B.M. 231.60m Bench Mark **Buildings with Building Seed**
Roofed Building **Glazed Roof Building**
Civil parish/community boundary
District boundary
County boundary
Boundary post/stone
Boundary mereing symbol (note: these always appear in opposed pairs or groups of three)
Bks Barracks **P** Pillar, Pole or Post
Bty Battery **PO** Post Office
Cemy Cemetery **PC** Public Convenience
Chy Chimney **Pp** Pump
Cis Cistern **Ppg Sta** Pumping Station
Dismtd Rly Dismantled Railway **PW** Place of Worship
EI Gen Sta Electricity Generating Station **Sewage Ppg Sta** Sewage Pumping Station
EI P Electricity Pole, Pillar **SB, S Br** Signal Box or Bridge
EI Sub Sta Electricity Sub Station **SP, SL** Signal Post or Light
FB Filter Bed **Spr** Spring
Fn / D Fn Fountain / Drinking Ftn. **Tk** Tank or Track
Gas Gov Gas Valve Compound **Tr** Trough
GVC Gas Governor **Wd Pp** Wind Pump
GP Guide Post **Wr Pt, Wr T** Water Point, Water Tap
MH Manhole **Wks** Works (building or area)
MP, MS Mile Post or Mile Stone **W** Well



Historical Mapping & Photography included:

Mapping Type	Scale	Date	Pg
Lincolnshire	1:2,500	1886	2
Lincolnshire	1:2,500	1906	3
Ordnance Survey Plan	1:2,500	1973 - 1974	4
Large-Scale National Grid Data	1:2,500	1994	5

Historical Map - Segment E7

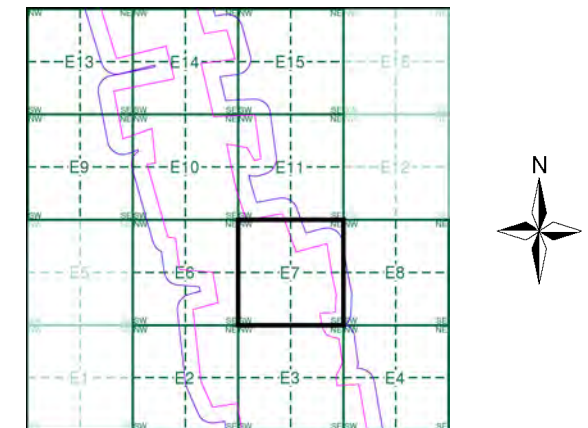

Order Details

Order Number: 297990273_1_1
 Customer Ref: 21-1088.04
 National Grid Reference: 489860, 387850
 Slice: E
 Site Area (Ha): 469.98
 Search Buffer (m): 100

Site Details

Cottam



Tel: [Redacted]
 Fax: [Redacted]
 Web: [Redacted]

Lincolnshire
Published 1886

Source map scale - 1:2,500

The historical maps shown were reproduced from maps predominantly held at the scale adopted for England, Wales and Scotland in the 1840's. In 1854 the 1:2,500 scale was adopted for mapping urban areas and by 1896 it covered the whole of what were considered to be the cultivated parts of Great Britain. The published date given below is often some years later than the surveyed date. Before 1938, all OS maps were based on the Cassini Projection, with independent surveys of a single county or group of counties, giving rise to significant inaccuracies in outlying areas.

Map Name(s) and Date(s)

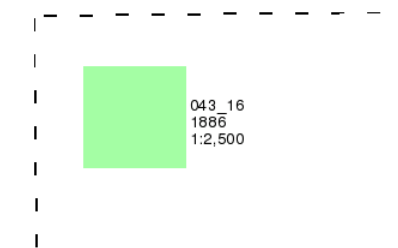

Historical Map - Segment E7

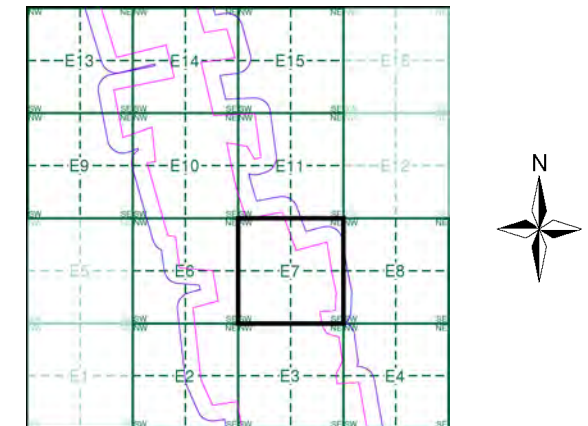

Order Details

Order Number: 297990273_1_1
 Customer Ref: 21-1088.04
 National Grid Reference: 489860, 387850
 Slice: E
 Site Area (Ha): 469.98
 Search Buffer (m): 100

Site Details

Cottam

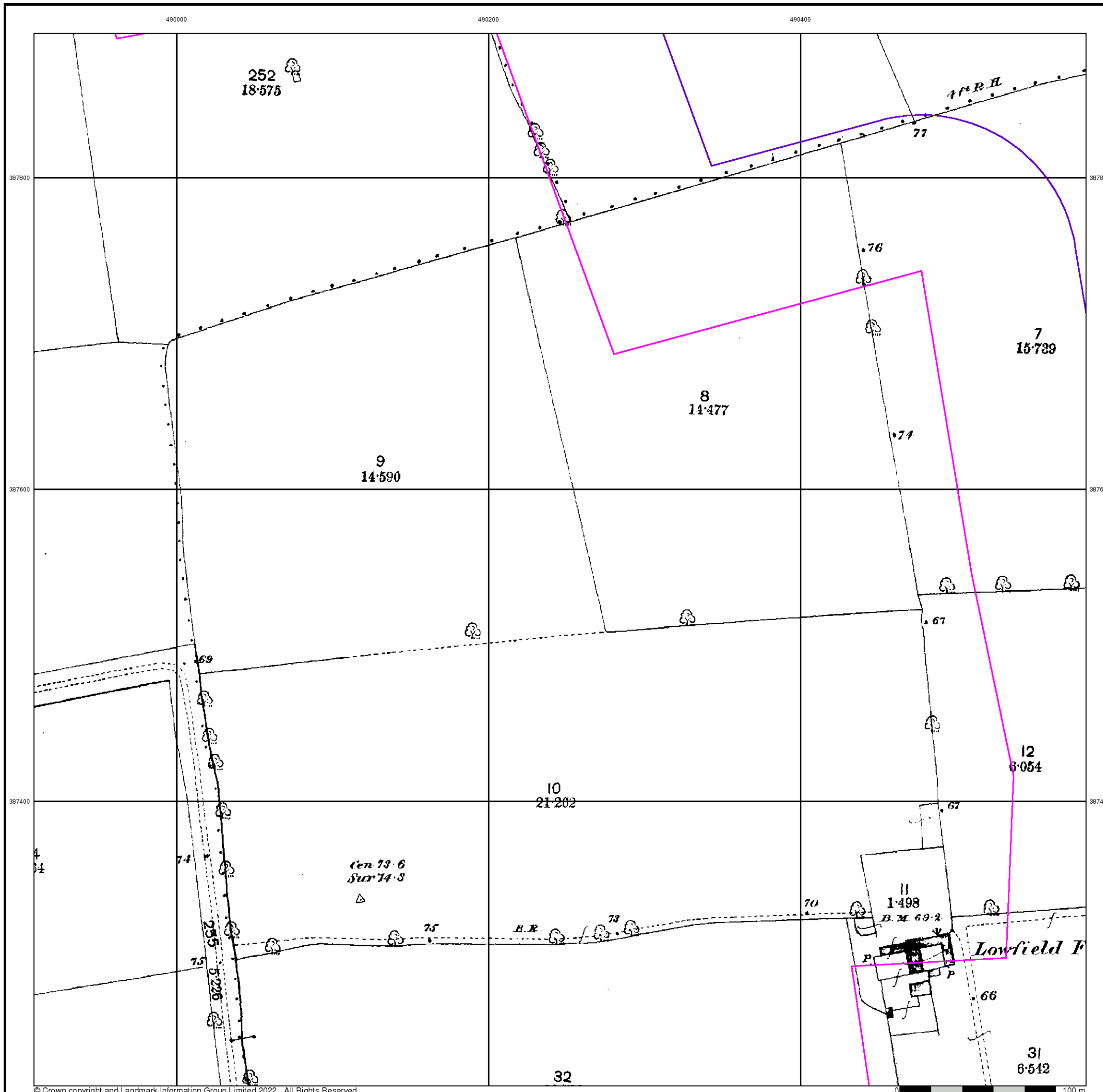

Lincolnshire
Published 1906

Source map scale - 1:2,500

The historical maps shown were reproduced from maps predominantly held at the scale adopted for England, Wales and Scotland in the 1840's. In 1854 the 1:2,500 scale was adopted for mapping urban areas and by 1896 it covered the whole of what were considered to be the cultivated parts of Great Britain. The published date given below is often some years later than the surveyed date. Before 1938, all OS maps were based on the Cassini Projection, with independent surveys of a single county or group of counties, giving rise to significant inaccuracies in outlying areas.

Map Name(s) and Date(s)

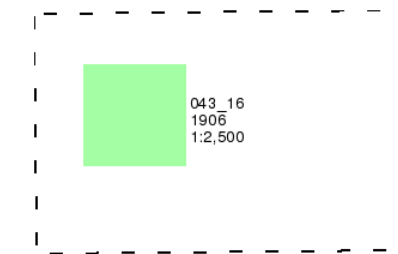

Historical Map - Segment E7

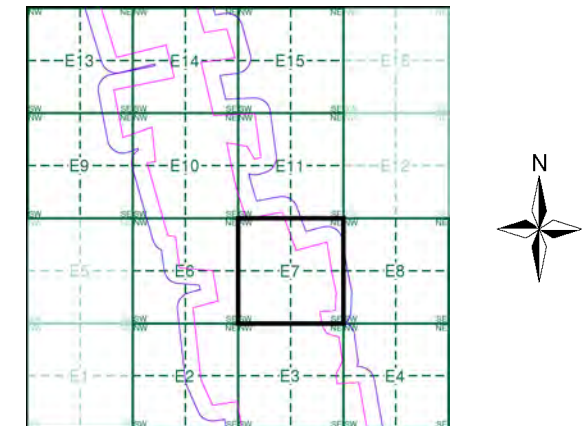

Order Details

Order Number: 297990273_1_1
 Customer Ref: 21-1088.04
 National Grid Reference: 489860, 387850
 Slice: E
 Site Area (Ha): 469.98
 Search Buffer (m): 100

Site Details

Cottam

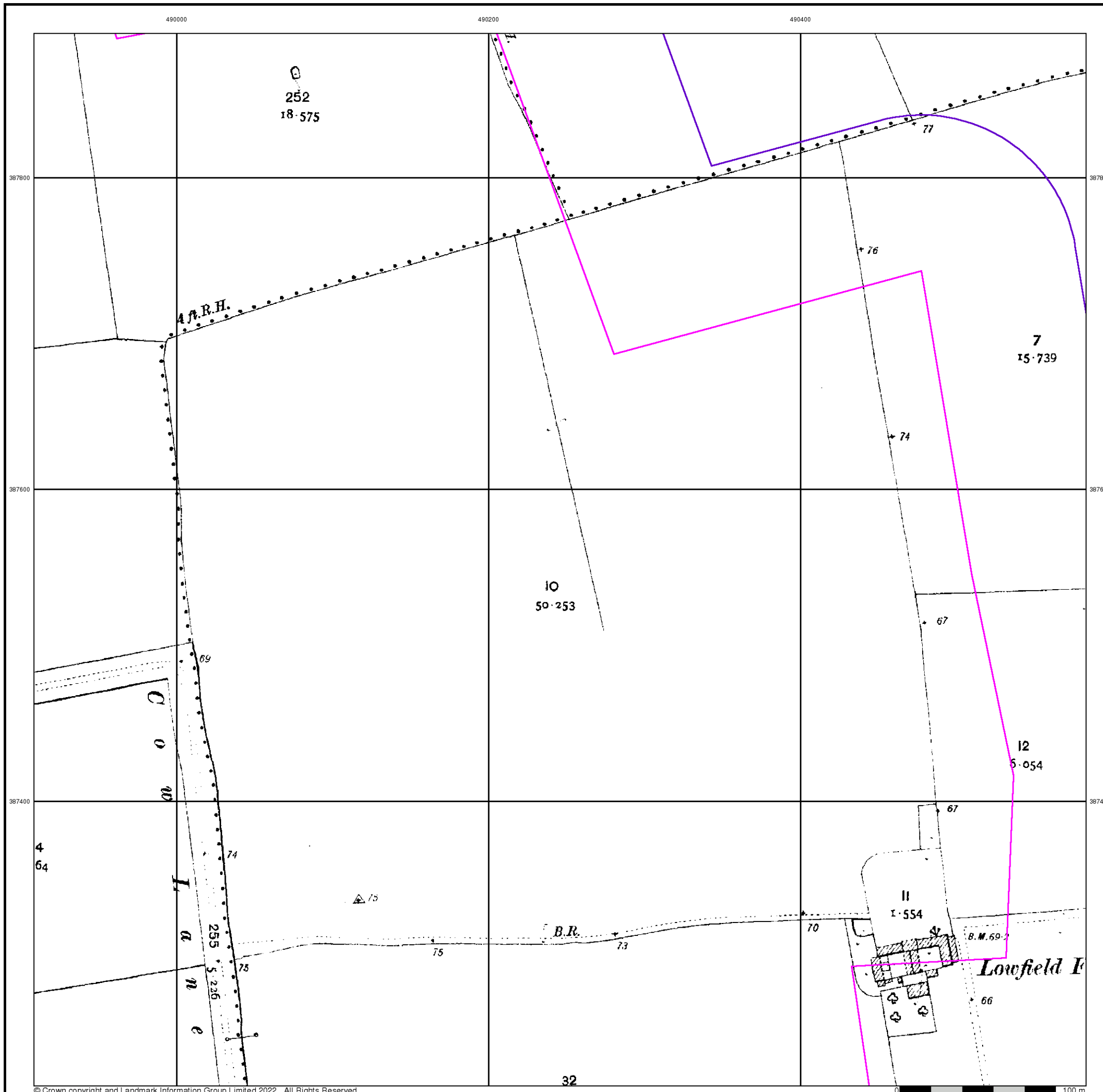

Large-Scale National Grid Data Published 1994

Source map scale - 1:2,500

'Large Scale National Grid Data' superseded SIM cards (Ordnance Survey's 'Survey of Information on Microfilm') in 1992, and continued to be produced until 1999. These maps were the fore-runners of digital mapping and so provide detailed information on houses and roads, but tend to show less topographic features such as vegetation. These maps were produced at both 1:2,500 and 1:1,250 scales.

Map Name(s) and Date(s)

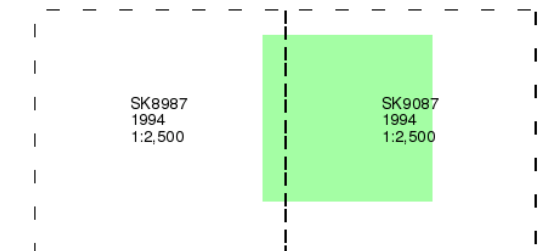

Historical Map - Segment E7

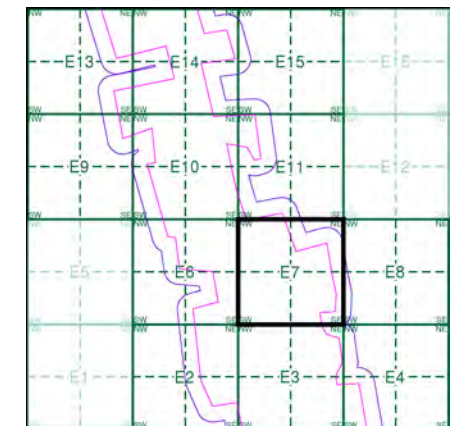

Order Details

Order Number: 297990273_1_1
 Customer Ref: 21-1088.04
 National Grid Reference: 489860, 387850
 Slice: E
 Site Area (Ha): 469.98
 Search Buffer (m): 100

Site Details

Cottam

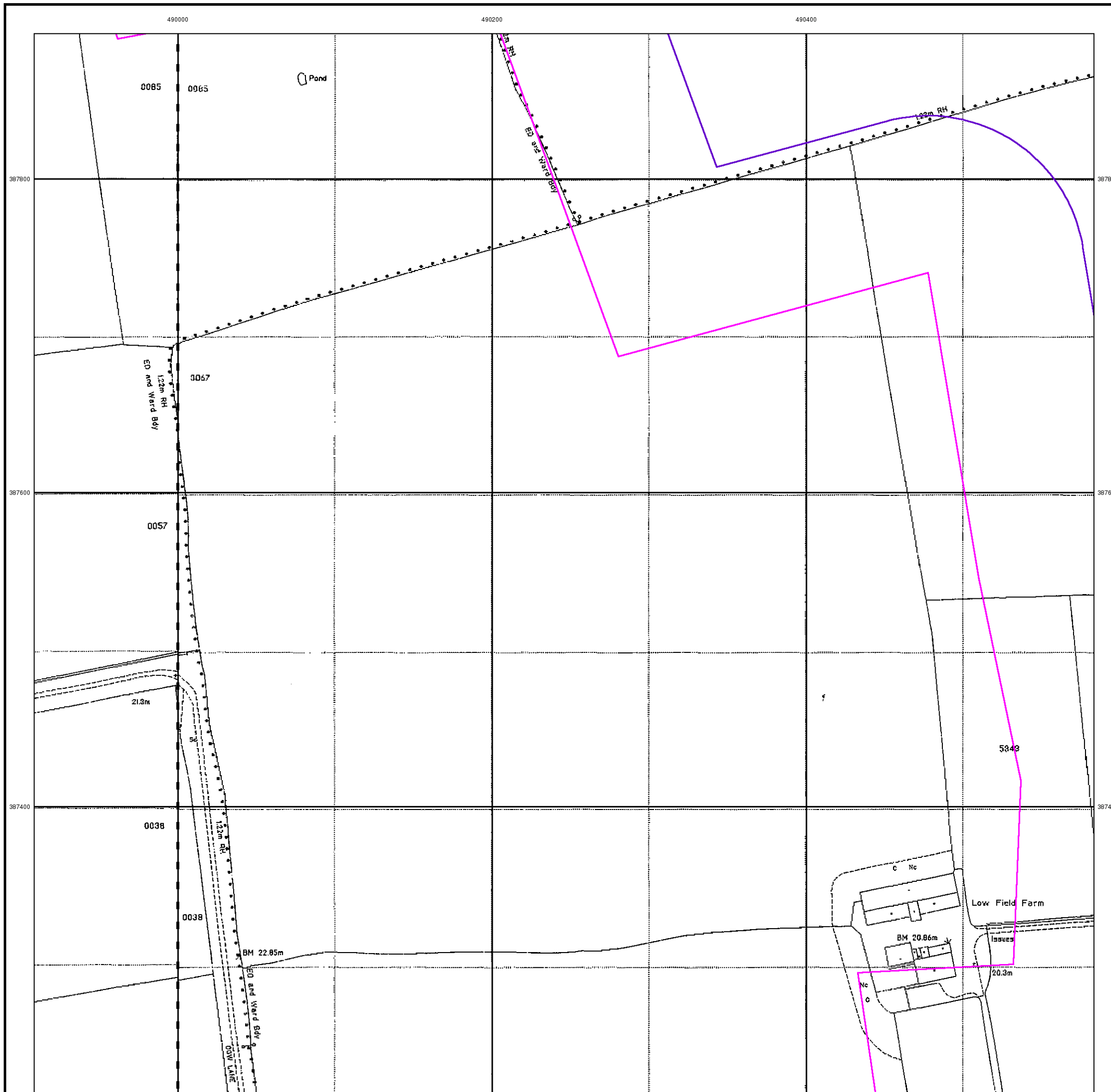

Historical Mapping Legends

Ordnance Survey County Series and Ordnance Survey Plan 1:2,500

Quarry **Gravel Pit** **Sand Pit**
Clay Pit **Shingle** **Refuse Heap**
Sloping Masonry **Flat Rock**
Marsh **Reeds** **Osiers**
Rough Pasture **Furze** **Wood**
Mixed Wood **Brushwood** **Orchard**
Fir **Ford** **Stepping Stones**
Ferry **Waterfall** **Lock**
Trig. Station **Altitude at Trig. Station**
B.M. 325.9 **Bench Mark** **Surface Level**
Arrow denotes flow of water **Antiquities (site of)**
Cutting **Embankment**
Railway crossing Road **Level Crossing** **Road crossing Railway**
Railway crossing River or Canal **Road over single stream** **Road over River or Canal**
County Boundary (Geographical)
County & Civil Parish Boundary
Administrative County & Civil Parish Boundary
County Borough Boundary (England)
Co. Boro. Bdy.
County Burgh Boundary (Scotland)
Boundary Post or Stone **Police Call Box**
B.R. **Bridle Road** **P** **Pump**
E.P. **Electricity Pylon** **S.P.** **Signal Post**
F.B. **Foot Bridge** **Sl.** **Sluice**
F.P. **Foot Path** **Sp.** **Spring**
G.P. **Guide Post or Board** **T.C.B.** **Telephone Call Box**
M.S. **Mile Stone** **Tr.** **Trough**
M.P. M.R. **Mooring Post or Ring** **W** **Well**

Ordnance Survey Plan, Additional SIMs and Supply of Unpublished Survey Information 1:2,500 and 1:1,250

Inactive Quarry, Chalk Pit or Clay Pit **Active Quarry, Chalk Pit or Clay Pit**
Rock **Boulders**
Cliff **Slopes** **Top**
Roofed Building **Glazed Roof Building**
Sloping Masonry **Archway**
Non-Coniferous Tree (surveyed) **Coniferous Tree (surveyed)**
Non-Coniferous Trees (not surveyed) **Coniferous Trees (not surveyed)**
Orchard Tree **Scrub** **Bracken**
Coppice, Osier **Reeds** **Marsh, Saltings**
Rough Grassland **Heath** **Culvert**
Direction of water flow **Bench Mark** **Antiquity (site of)**
Cave Entrance **Triangulation Station** **Electricity Pylon**
Electricity Transmission Line
County Boundary (Geographical)
County & Civil Parish Boundary
Civil Parish Boundary
Admin. County or County Bor. Boundary
London Borough Boundary
Symbol marking point where boundary mereing changes
BH **Beer House** **P** **Pillar, Pole or Post**
BP, BS **Boundary Post or Stone** **PO** **Post Office**
Cn, C **Capstan, Crane** **PC** **Public Convenience**
Chy **Chimney** **PH** **Public House**
D Fn **Drinking Fountain** **Pp** **Pump**
EI P **Electricity Pillar or Post** **SB, S Br** **Signal Box or Bridge**
FAP **Fire Alarm Pillar** **SP, SL** **Signal Post or Light**
FB **Foot Bridge** **Spr** **Spring**
GP **Guide Post** **Tk** **Tank or Track**
H **Hydrant or Hydraulic** **TCB** **Telephone Call Box**
LC **Level Crossing** **TCP** **Telephone Call Post**
MH **Manhole** **Tr** **Trough**
MP **Mile Post or Mooring Post** **Wr Pt, Wr T** **Water Point, Water Tap**
MS **Mile Stone** **W** **Well**
NTL **Normal Tidal Limit** **Wd Pp** **Wind Pump**

Large-Scale National Grid Data 1:2,500 and 1:1,250

Cliff **Slopes** **Top**
Rock **Rock (scattered)**
Boulders **Boulders (scattered)**
Positioned Boulder **Scree**
Non-Coniferous Tree (surveyed) **Coniferous Tree (surveyed)**
Non-Coniferous Trees (not surveyed) **Coniferous Trees (not surveyed)**
Orchard Tree **Scrub** **Bracken**
Coppice, Osier **Reeds** **Marsh, Saltings**
Rough Grassland **Heath** **Culvert**
Direction of water flow **Triangulation Station** **Antiquity (site of)**
Electricity Transmission Line **Electricity Pylon**
B.M. 231.60m **Bench Mark** **Buildings with Building Seed**
Roofed Building **Glazed Roof Building**
Civil parish/community boundary
District boundary
County boundary
Boundary post/stone
Boundary mereing symbol (note: these always appear in opposed pairs or groups of three)
Bks **Barracks** **P** **Pillar, Pole or Post**
Bty **Battery** **PO** **Post Office**
Cemy **Cemetery** **PC** **Public Convenience**
Chy **Chimney** **Pp** **Pump**
Cis **Cistern** **Ppg Sta** **Pumping Station**
Dismtd Rly **Dismantled Railway** **PW** **Place of Worship**
EI Gen Sta **Electricity Generating Station** **Sewage Ppg Sta** **Sewage Pumping Station**
EI P **Electricity Pole, Pillar** **SB, S Br** **Signal Box or Bridge**
EI Sub Sta **Electricity Sub Station** **SP, SL** **Signal Post or Light**
FB **Filter Bed** **Spr** **Spring**
Fn / D Fn **Fountain / Drinking Ftn.** **Tk** **Tank or Track**
Gas Gov **Gas Valve Compound** **Tr** **Trough**
GVC **Gas Governor** **Wd Pp** **Wind Pump**
GP **Guide Post** **Wr Pt, Wr T** **Water Point, Water Tap**
MH **Manhole** **Wks** **Works (building or area)**
MP, MS **Mile Post or Mile Stone** **W** **Well**



Historical Mapping & Photography included:

Mapping Type	Scale	Date	Pg
Lincolnshire	1:2,500	1886	2
Lincolnshire	1:2,500	1906	3
Ordnance Survey Plan	1:2,500	1974	4
Large-Scale National Grid Data	1:2,500	1994	5

Historical Map - Segment E8

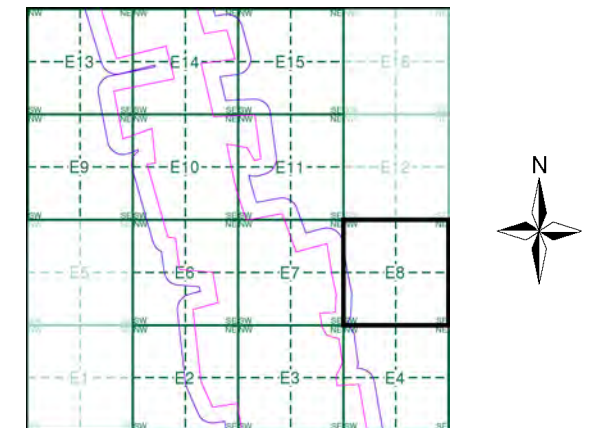

Order Details

Order Number: 297990273_1_1
 Customer Ref: 21-1088.04
 National Grid Reference: 489860, 387850
 Slice: E
 Site Area (Ha): 469.98
 Search Buffer (m): 100

Site Details

Cottam



Tel: [Redacted]
 Fax: [Redacted]
 Web: [Redacted]

Lincolnshire
Published 1886

Source map scale - 1:2,500

The historical maps shown were reproduced from maps predominantly held at the scale adopted for England, Wales and Scotland in the 1840's. In 1854 the 1:2,500 scale was adopted for mapping urban areas and by 1896 it covered the whole of what were considered to be the cultivated parts of Great Britain. The published date given below is often some years later than the surveyed date. Before 1938, all OS maps were based on the Cassini Projection, with independent surveys of a single county or group of counties, giving rise to significant inaccuracies in outlying areas.

Map Name(s) and Date(s)

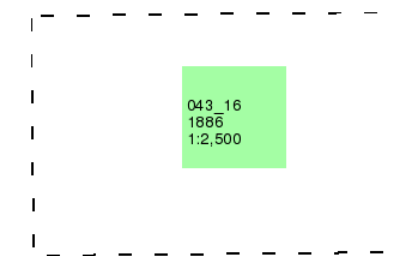

Historical Map - Segment E8

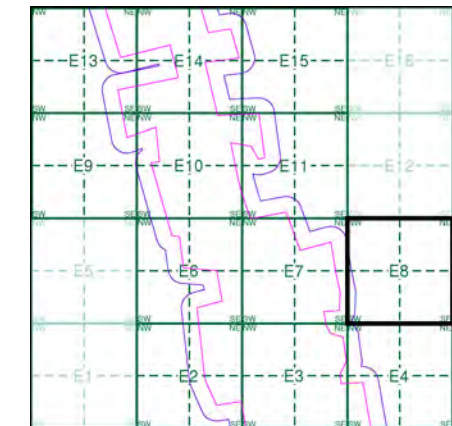

Order Details

Order Number: 297990273_1_1
 Customer Ref: 21-1088.04
 National Grid Reference: 489860, 387850
 Slice: E
 Site Area (Ha): 469.98
 Search Buffer (m): 100

Site Details

Cottam

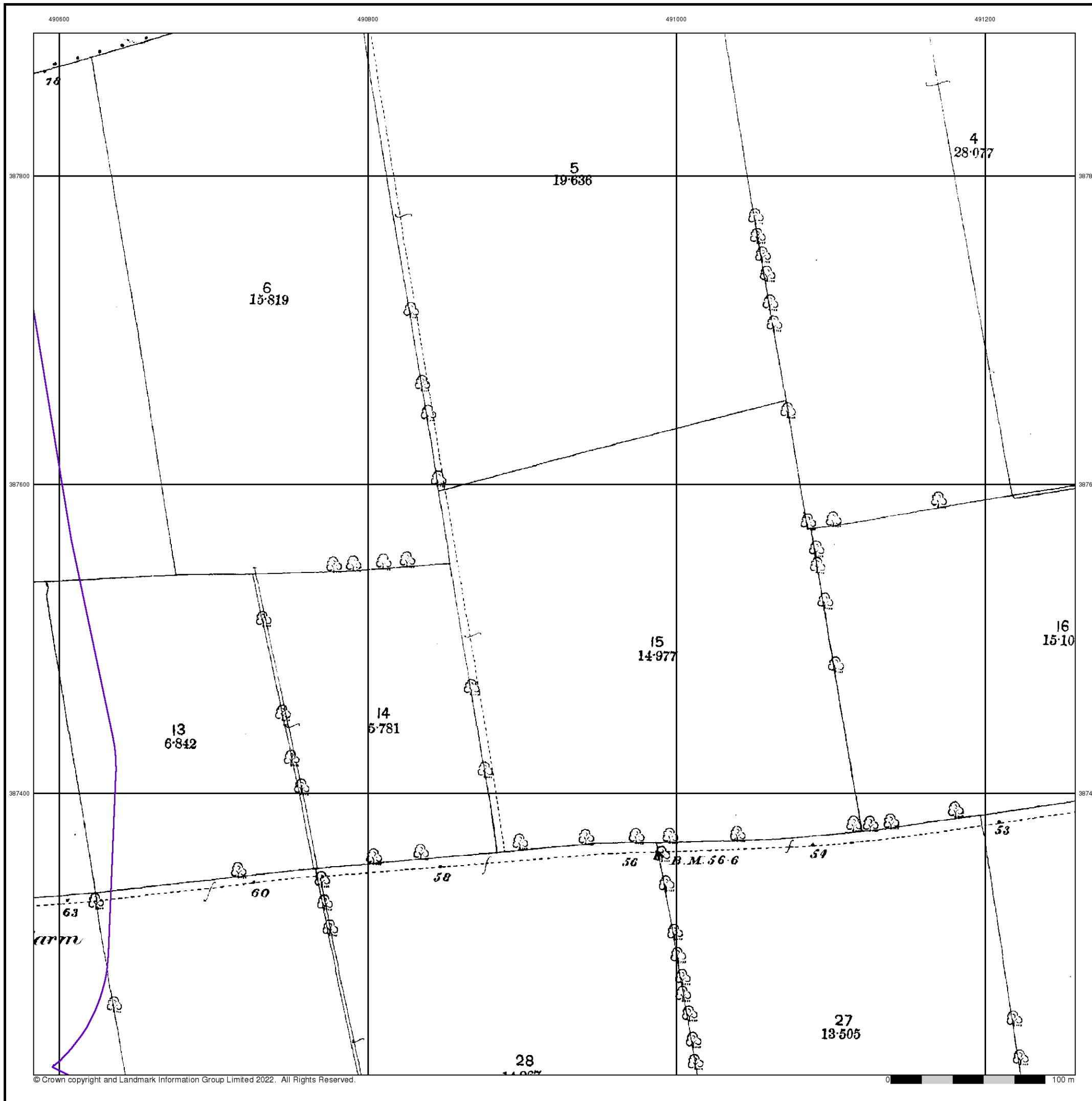

Lincolnshire
Published 1906

Source map scale - 1:2,500

The historical maps shown were reproduced from maps predominantly held at the scale adopted for England, Wales and Scotland in the 1840's. In 1854 the 1:2,500 scale was adopted for mapping urban areas and by 1896 it covered the whole of what were considered to be the cultivated parts of Great Britain. The published date given below is often some years later than the surveyed date. Before 1938, all OS maps were based on the Cassini Projection, with independent surveys of a single county or group of counties, giving rise to significant inaccuracies in outlying areas.

Map Name(s) and Date(s)

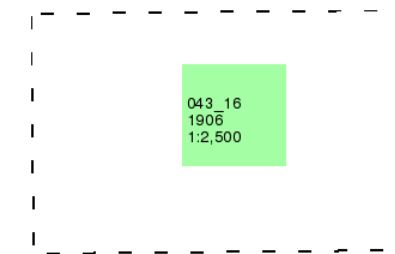

Historical Map - Segment E8

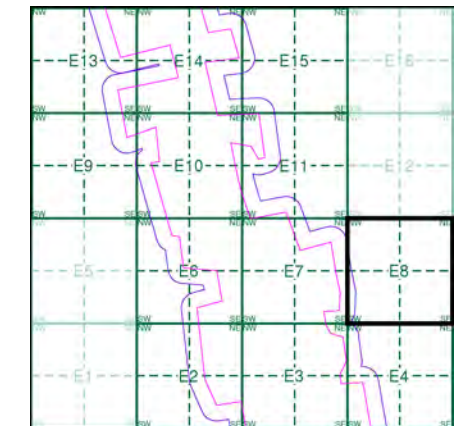

Order Details

Order Number: 297990273_1_1
 Customer Ref: 21-1088.04
 National Grid Reference: 489860, 387850
 Slice: E
 Site Area (Ha): 469.98
 Search Buffer (m): 100

Site Details

Cottam

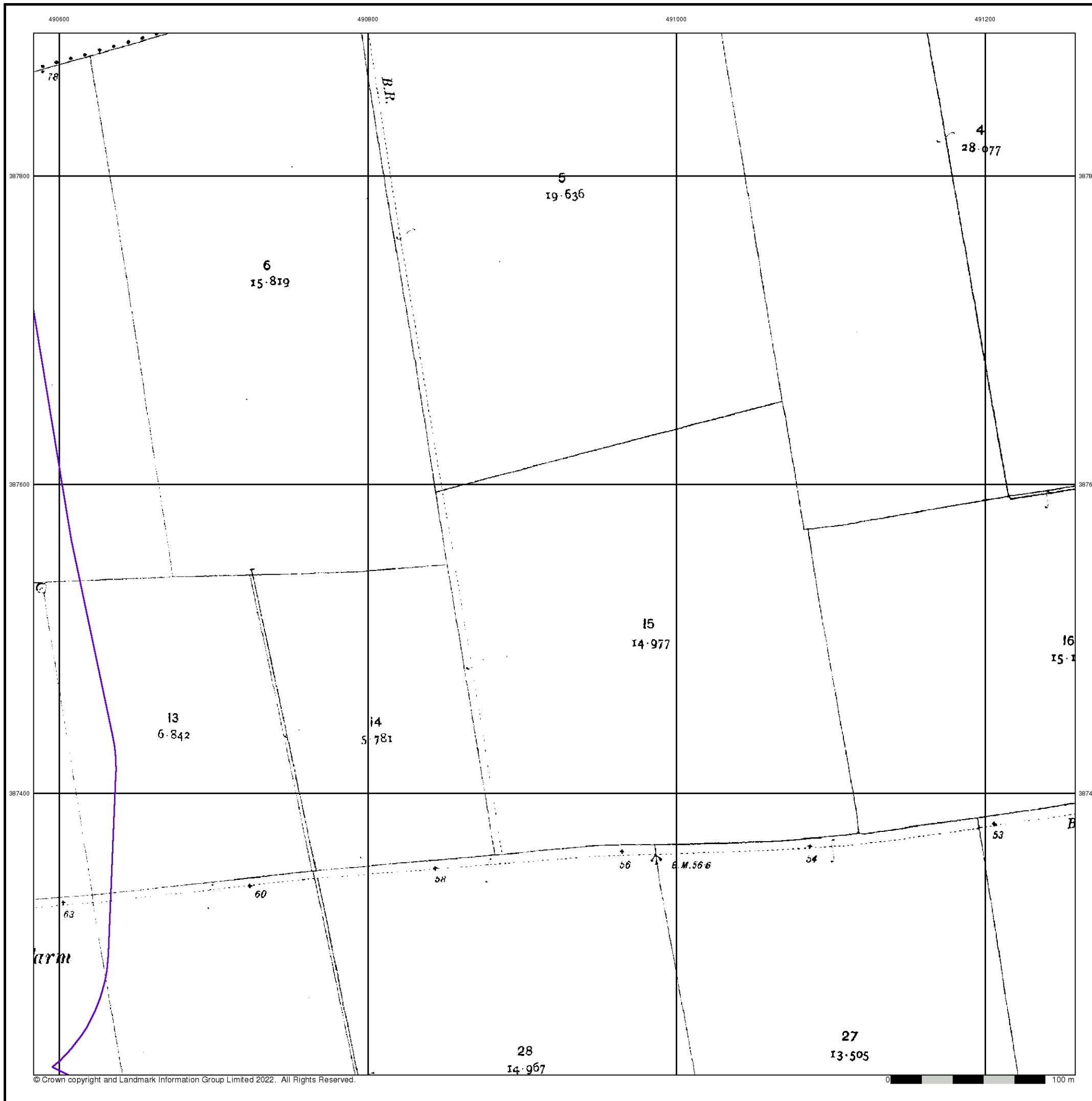

Ordnance Survey Plan

Published 1974

Source map scale - 1:2,500

The historical maps shown were reproduced from maps predominantly held at the scale adopted for England, Wales and Scotland in the 1840's. In 1854 the 1:2,500 scale was adopted for mapping urban areas and by 1896 it covered the whole of what were considered to be the cultivated parts of Great Britain. The published date given below is often some years later than the surveyed date. Before 1938, all OS maps were based on the Cassini Projection, with independent surveys of a single county or group of counties, giving rise to significant inaccuracies in outlying areas.

Map Name(s) and Date(s)

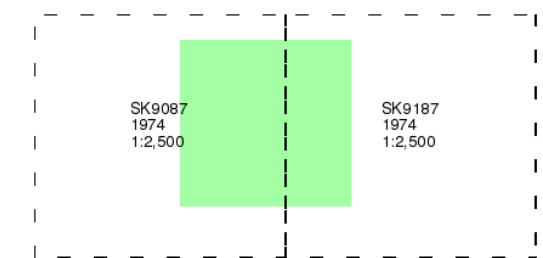

Historical Map - Segment E8

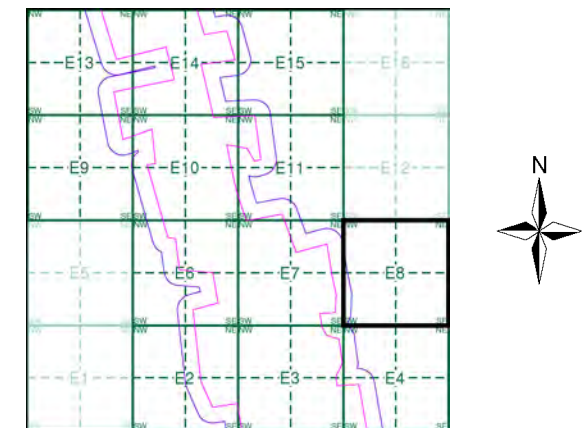

Order Details

Order Number: 297990273_1_1
 Customer Ref: 21-1088.04
 National Grid Reference: 489860, 387850
 Slice: E
 Site Area (Ha): 469.98
 Search Buffer (m): 100

Site Details

Cottam

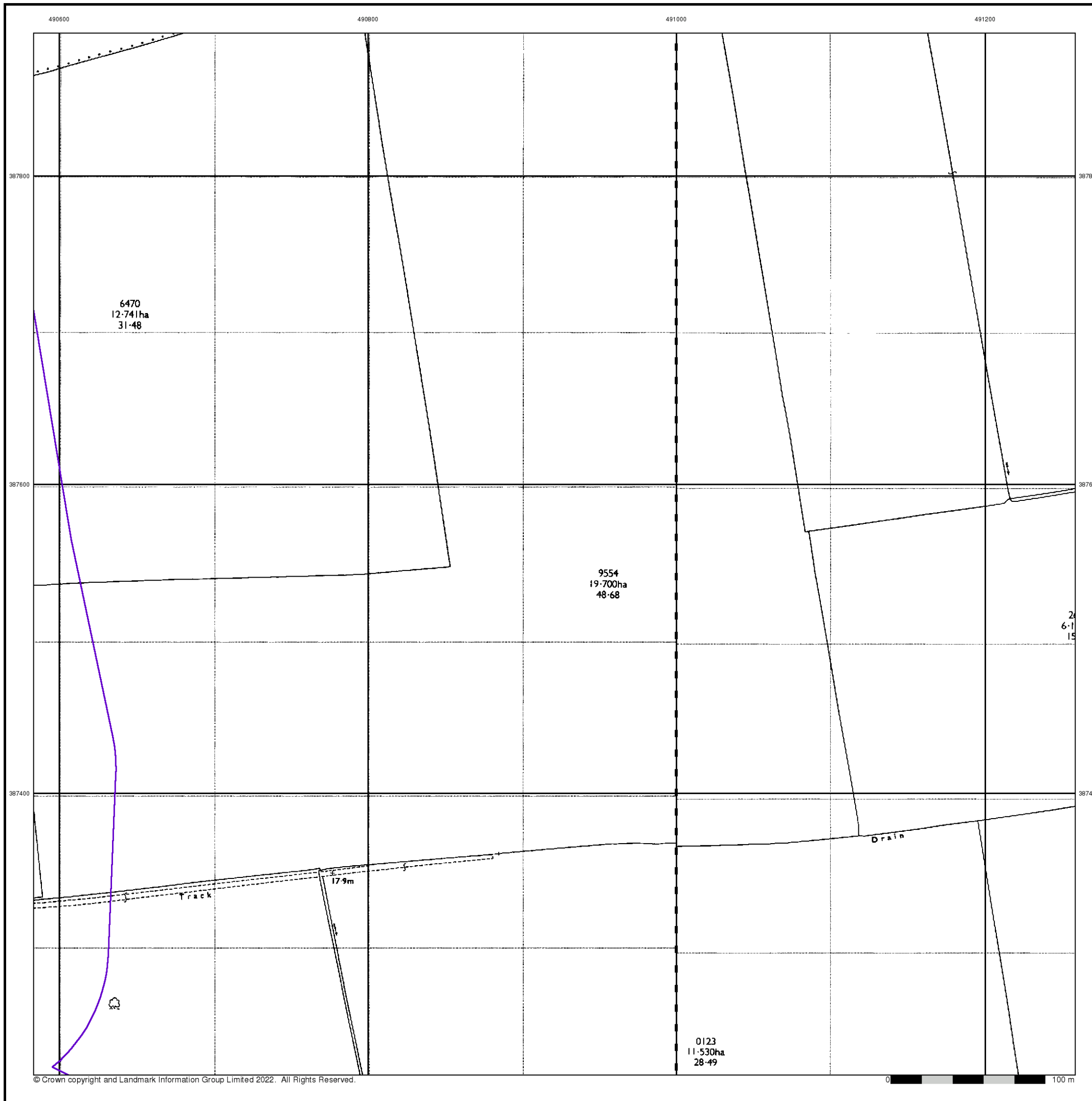

Large-Scale National Grid Data

Published 1994

Source map scale - 1:2,500

'Large Scale National Grid Data' superseded SIM cards (Ordnance Survey's 'Survey of Information on Microfilm') in 1992, and continued to be produced until 1999. These maps were the fore-runners of digital mapping and so provide detailed information on houses and roads, but tend to show less topographic features such as vegetation. These maps were produced at both 1:2,500 and 1:1,250 scales.

Map Name(s) and Date(s)

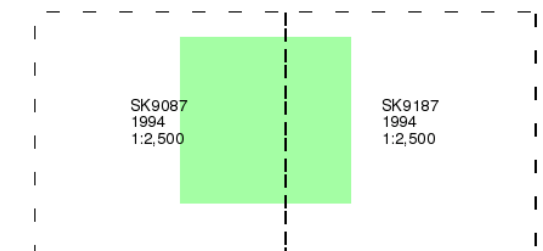

Historical Map - Segment E8

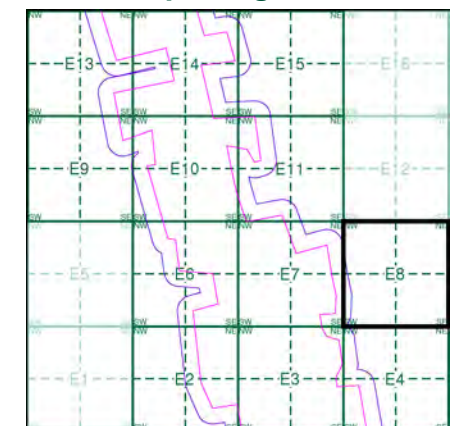

Order Details

Order Number: 297990273_1_1
 Customer Ref: 21-1088.04
 National Grid Reference: 489860, 387850
 Slice: E
 Site Area (Ha): 469.98
 Search Buffer (m): 100

Site Details

Cottam

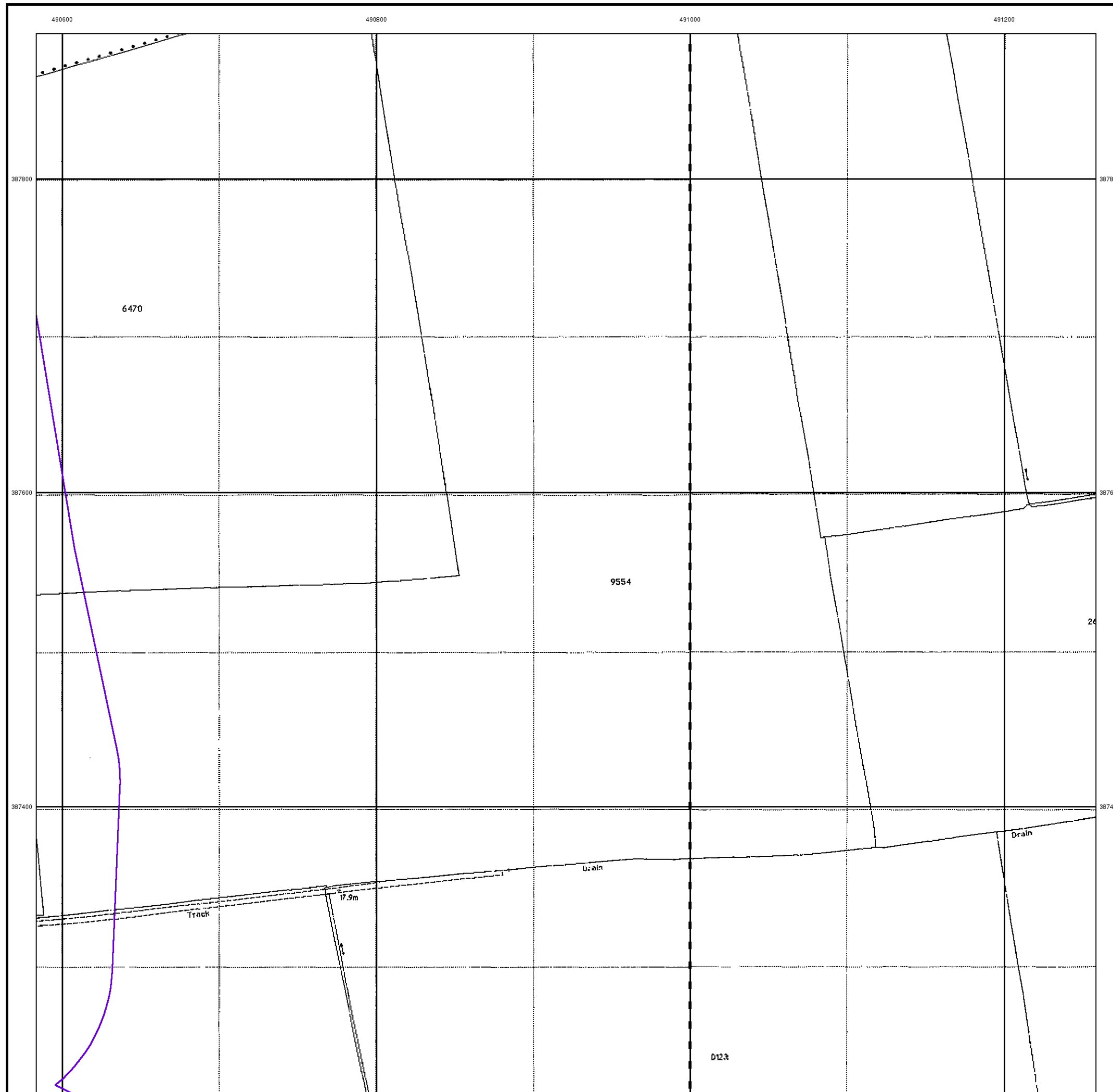

Historical Mapping Legends

Ordnance Survey County Series and Ordnance Survey Plan 1:2,500

Quarry **Gravel Pit** **Sand Pit**
Clay Pit **Shingle** **Refuse Heap**
Sloping Masonry **Flat Rock**
Marsh **Reeds** **Osiers**
Rough Pasture **Furze** **Wood**
Mixed Wood **Brushwood** **Orchard**
Fir **Ford** **Stepping Stones**
Ferry **Waterfall** **Lock**
Trig. Station **Altitude at Trig. Station**
B.M. 325.9 **Bench Mark** **Surface Level**
Arrow denotes flow of water **Antiquities (site of)**
Cutting **Embankment**
Railway crossing Road **Level Crossing** **Road crossing Railway**
Railway crossing River or Canal **Road over single stream** **Road over River or Canal**
County Boundary (Geographical)
County & Civil Parish Boundary
Administrative County & Civil Parish Boundary
County Borough Boundary (England)
Co. Boro. Bdy.
County Burgh Boundary (Scotland)
Co. Burgh Bdy.
B.P. B.S. Boundary Post or Stone **P.C.B.** Police Call Box
B.R. Bridle Road **P.** Pump
E.P. Electricity Pylon **S.P.** Signal Post
F.B. Foot Bridge **Sl.** Sluice
F.P. Foot Path **Sp.** Spring
G.P. Guide Post or Board **T.C.B.** Telephone Call Box
M.S. Mile Stone **Tr.** Trough
M.P. M.R. Mooring Post or Ring **W.** Well

Ordnance Survey Plan, Additional SIMs and Supply of Unpublished Survey Information 1:2,500 and 1:1,250

Inactive Quarry, Chalk Pit or Clay Pit **Active Quarry, Chalk Pit or Clay Pit**
Rock **Boulders**
Cliff **Slopes** **Top**
Roofed Building **Glazed Roof Building**
Sloping Masonry **Archway**
Non-Coniferous Tree (surveyed) **Coniferous Tree (surveyed)**
Non-Coniferous Trees (not surveyed) **Coniferous Trees (not surveyed)**
Orchard Tree **Scrub** **Bracken**
Coppice, Osier **Reeds** **Marsh, Saltings**
Rough Grassland **Heath** **Culvert**
Direction of water flow **Bench Mark** **Antiquity (site of)**
Cave Entrance **Triangulation Station** **Electricity Pylon**
Electricity Transmission Line
County Boundary (Geographical)
County & Civil Parish Boundary
Civil Parish Boundary
Admin. County or County Bor. Boundary
London Borough Boundary
Symbol marking point where boundary mereing changes
BH Beer House **P** Pillar, Pole or Post
BP, BS Boundary Post or Stone **PO** Post Office
Cn, C Capstan, Crane **PC** Public Convenience
Chy Chimney **PH** Public House
D Fn Drinking Fountain **Pp** Pump
EI P Electricity Pillar or Post **SB, S Br** Signal Box or Bridge
FAP Fire Alarm Pillar **SP, SL** Signal Post or Light
FB Foot Bridge **Spr** Spring
GP Guide Post **Tk** Tank or Track
H Hydrant or Hydraulic **TCB** Telephone Call Box
LC Level Crossing **TCP** Telephone Call Post
MH Manhole **Tr** Trough
MP Mile Post or Mooring Post **Wr Pt, Wr T** Water Point, Water Tap
MS Mile Stone **W** Well
NTL Normal Tidal Limit **Wd Pp** Wind Pump

Large-Scale National Grid Data 1:2,500 and 1:1,250

Cliff **Slopes** **Top**
Rock **Rock (scattered)**
Boulders **Boulders (scattered)**
Positioned Boulder **Scree**
Non-Coniferous Tree (surveyed) **Coniferous Tree (surveyed)**
Non-Coniferous Trees (not surveyed) **Coniferous Trees (not surveyed)**
Orchard Tree **Scrub** **Bracken**
Coppice, Osier **Reeds** **Marsh, Saltings**
Rough Grassland **Heath** **Culvert**
Direction of water flow **Triangulation Station** **Antiquity (site of)**
Electricity Transmission Line **Electricity Pylon**
B.M. 231.60m Bench Mark **Buildings with Building Seed**
Roofed Building **Glazed Roof Building**
Civil parish/community boundary
District boundary
County boundary
Boundary post/stone
Boundary mereing symbol (note: these always appear in opposed pairs or groups of three)
Bks Barracks **P** Pillar, Pole or Post
Bty Battery **PO** Post Office
Cemy Cemetery **PC** Public Convenience
Chy Chimney **Pp** Pump
Cis Cistern **Ppg Sta** Pumping Station
Dismtd Rly Dismantled Railway **PW** Place of Worship
EI Gen Sta Electricity Generating Station **Sewage Ppg Sta** Sewage Pumping Station
EI P Electricity Pole, Pillar **SB, S Br** Signal Box or Bridge
EI Sub Sta Electricity Sub Station **SP, SL** Signal Post or Light
FB Filter Bed **Spr** Spring
Fn / D Fn Fountain / Drinking Ftn. **Tk** Tank or Track
Gas Gov Gas Valve Compound **Tr** Trough
GVC Gas Governor **Wd Pp** Wind Pump
GP Guide Post **Wr Pt, Wr T** Water Point, Water Tap
MH Manhole **Wks** Works (building or area)
MP, MS Mile Post or Mile Stone **W** Well



Historical Mapping & Photography included:

Mapping Type	Scale	Date	Pg
Lincolnshire	1:2,500	1886	2
Lincolnshire	1:2,500	1906	3
Ordnance Survey Plan	1:2,500	1972 - 1973	4
Large-Scale National Grid Data	1:2,500	1994	5

Historical Map - Segment E9

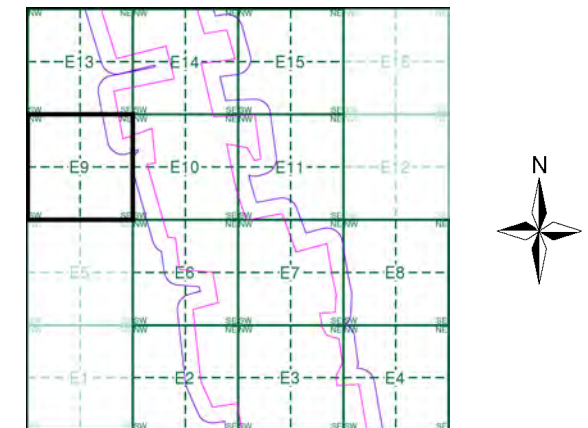

Order Details

Order Number: 297990273_1_1
 Customer Ref: 21-1088.04
 National Grid Reference: 489860, 387850
 Slice: E
 Site Area (Ha): 469.98
 Search Buffer (m): 100

Site Details

Cottam



Tel: [Redacted]
 Fax: [Redacted]
 Web: [Redacted]

Lincolnshire
Published 1886

Source map scale - 1:2,500

The historical maps shown were reproduced from maps predominantly held at the scale adopted for England, Wales and Scotland in the 1840's. In 1854 the 1:2,500 scale was adopted for mapping urban areas and by 1896 it covered the whole of what were considered to be the cultivated parts of Great Britain. The published date given below is often some years later than the surveyed date. Before 1938, all OS maps were based on the Cassini Projection, with independent surveys of a single county or group of counties, giving rise to significant inaccuracies in outlying areas.

Map Name(s) and Date(s)

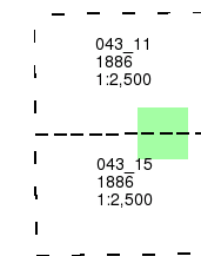

Historical Map - Segment E9

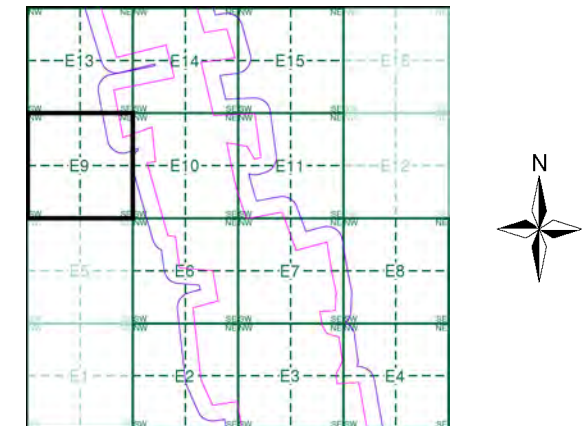

Order Details

Order Number: 297990273_1_1
 Customer Ref: 21-1088.04
 National Grid Reference: 489860, 387850
 Slice: E
 Site Area (Ha): 469.98
 Search Buffer (m): 100

Site Details

Cottam

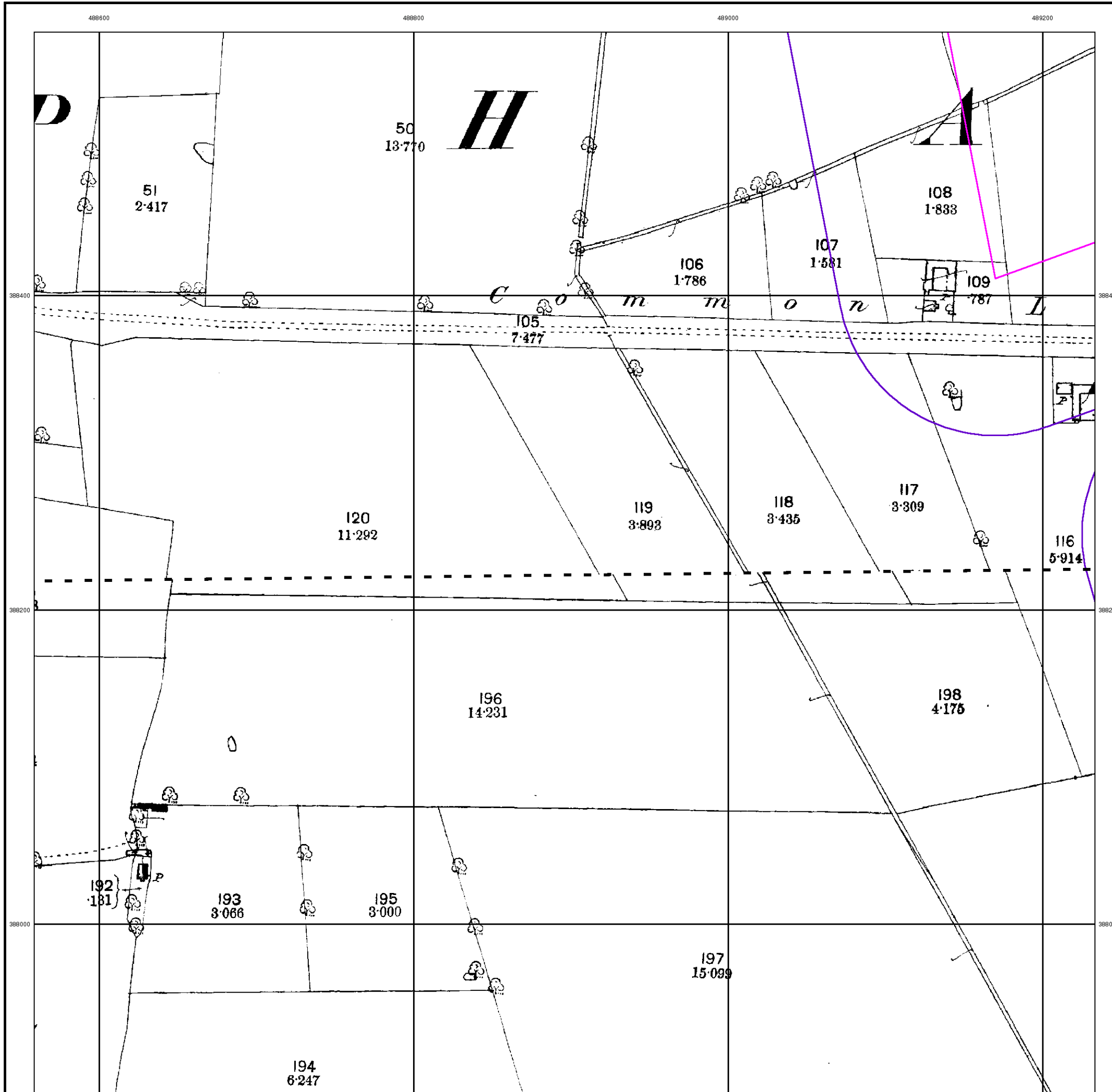

Lincolnshire

Published 1906

Source map scale - 1:2,500

The historical maps shown were reproduced from maps predominantly held at the scale adopted for England, Wales and Scotland in the 1840's. In 1854 the 1:2,500 scale was adopted for mapping urban areas and by 1896 it covered the whole of what were considered to be the cultivated parts of Great Britain. The published date given below is often some years later than the surveyed date. Before 1938, all OS maps were based on the Cassini Projection, with independent surveys of a single county or group of counties, giving rise to significant inaccuracies in outlying areas.

Map Name(s) and Date(s)

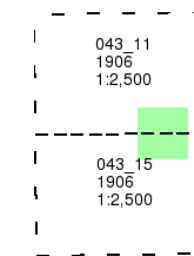

Historical Map - Segment E9

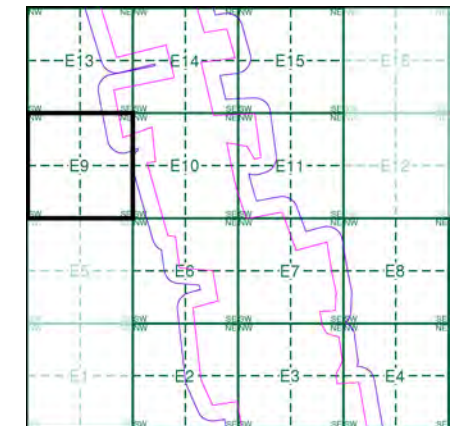

Order Details

Order Number: 297990273_1_1
 Customer Ref: 21-1088.04
 National Grid Reference: 489860, 387850
 Slice: E
 Site Area (Ha): 469.98
 Search Buffer (m): 100

Site Details

Cottam

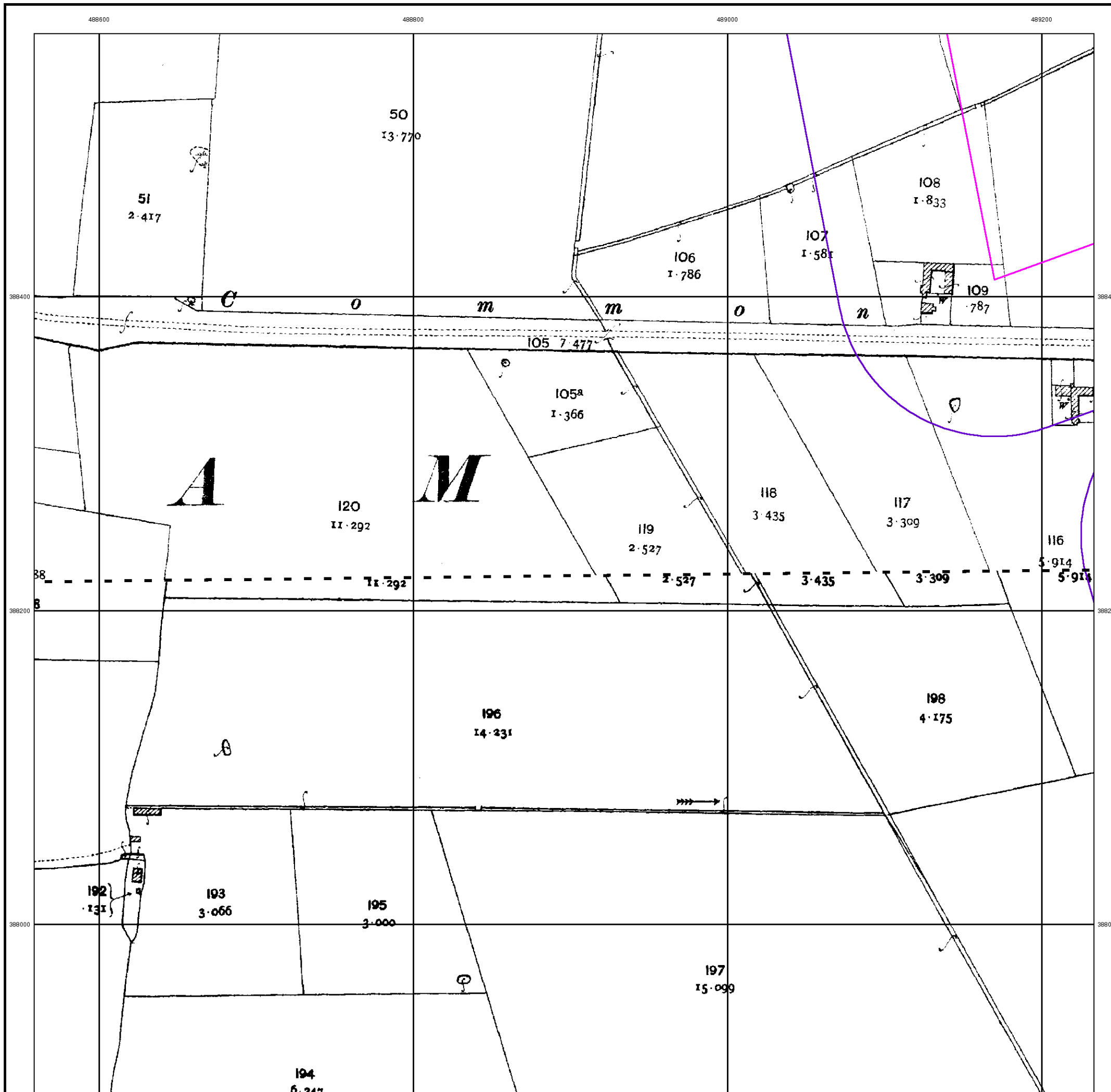

Ordnance Survey Plan
Published 1972 - 1973
Source map scale - 1:2,500

The historical maps shown were reproduced from maps predominantly held at the scale adopted for England, Wales and Scotland in the 1840's. In 1854 the 1:2,500 scale was adopted for mapping urban areas and by 1896 it covered the whole of what were considered to be the cultivated parts of Great Britain. The published date given below is often some years later than the surveyed date. Before 1938, all OS maps were based on the Cassini Projection, with independent surveys of a single county or group of counties, giving rise to significant inaccuracies in outlying areas.

Map Name(s) and Date(s)

SK8888 1972 1:2,500	SK8988 1972 1:2,500
SK8887 1973 1:2,500	SK8987 1973 1:2,500

Historical Map - Segment E9

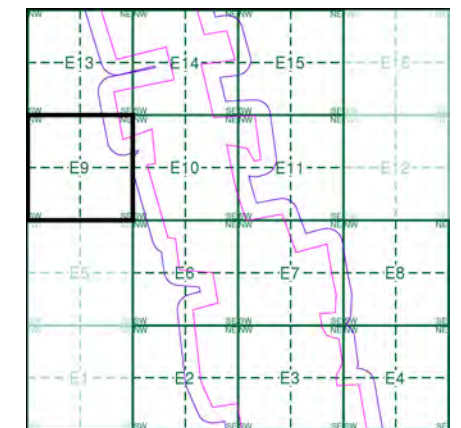

Order Details

Order Number: 297990273_1_1
 Customer Ref: 21-1088.04
 National Grid Reference: 489860, 387850
 Slice: E
 Site Area (Ha): 469.98
 Search Buffer (m): 100

Site Details

Cottam

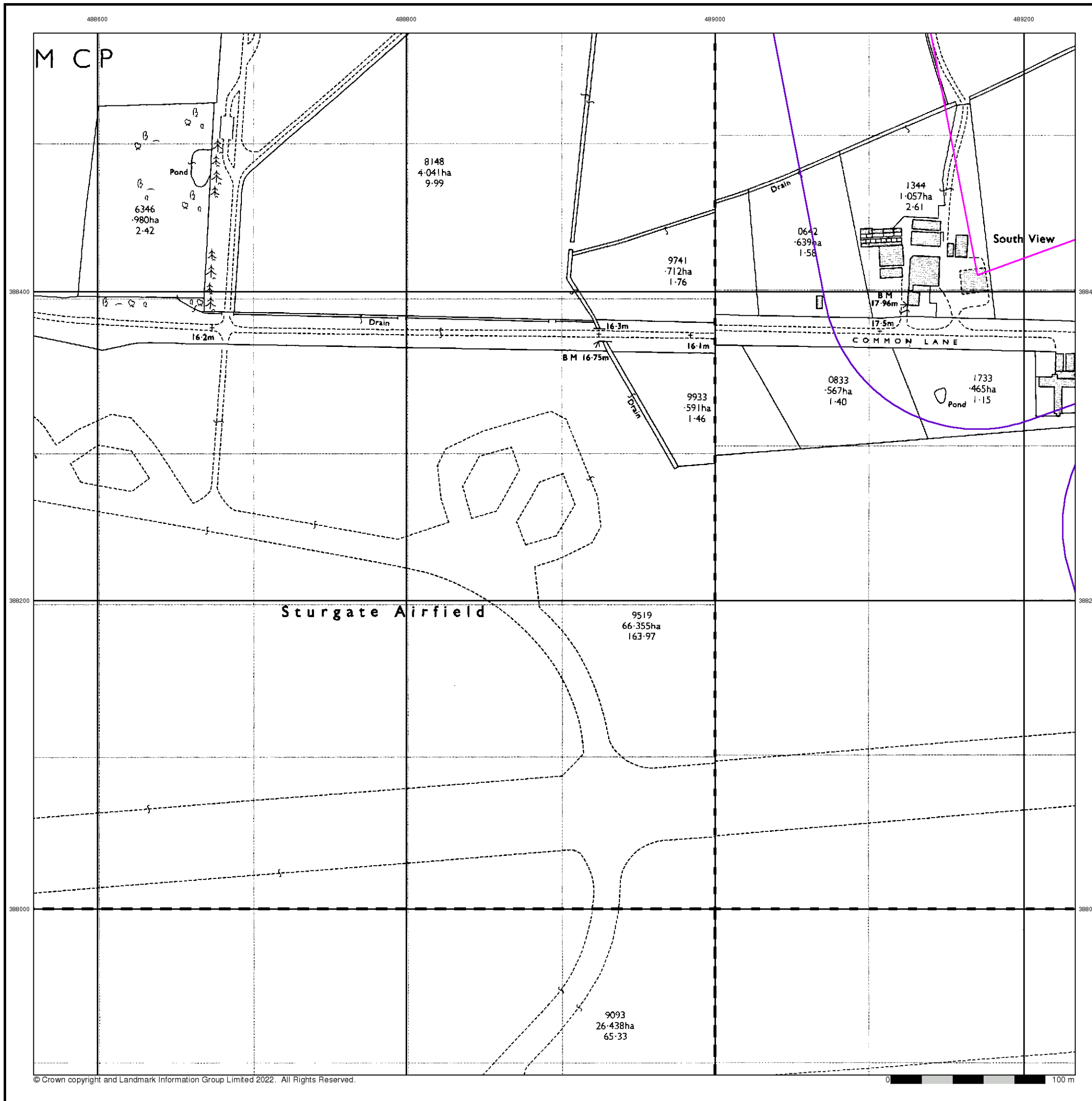

Large-Scale National Grid Data

Published 1994

Source map scale - 1:2,500

'Large Scale National Grid Data' superseded SIM cards (Ordnance Survey's 'Survey of Information on Microfilm') in 1992, and continued to be produced until 1999. These maps were the fore-runners of digital mapping and so provide detailed information on houses and roads, but tend to show less topographic features such as vegetation. These maps were produced at both 1:2,500 and 1:1,250 scales.

Map Name(s) and Date(s)

SK8888	SK8988
1994	1994
12,500	12,500
SK8887	SK8987
1994	1994
12,500	12,500

Historical Map - Segment E9

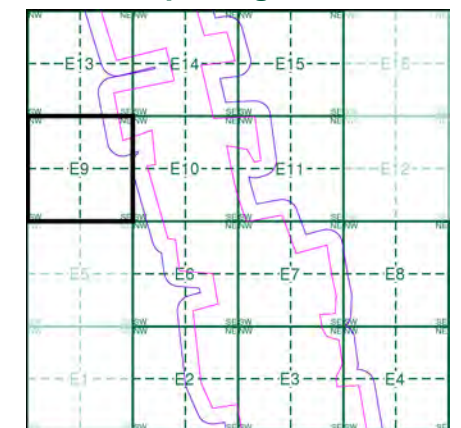

Order Details

Order Number: 297990273_1_1
 Customer Ref: 21-1088.04
 National Grid Reference: 489860, 387850
 Slice: E
 Site Area (Ha): 469.98
 Search Buffer (m): 100

Site Details

Cottam

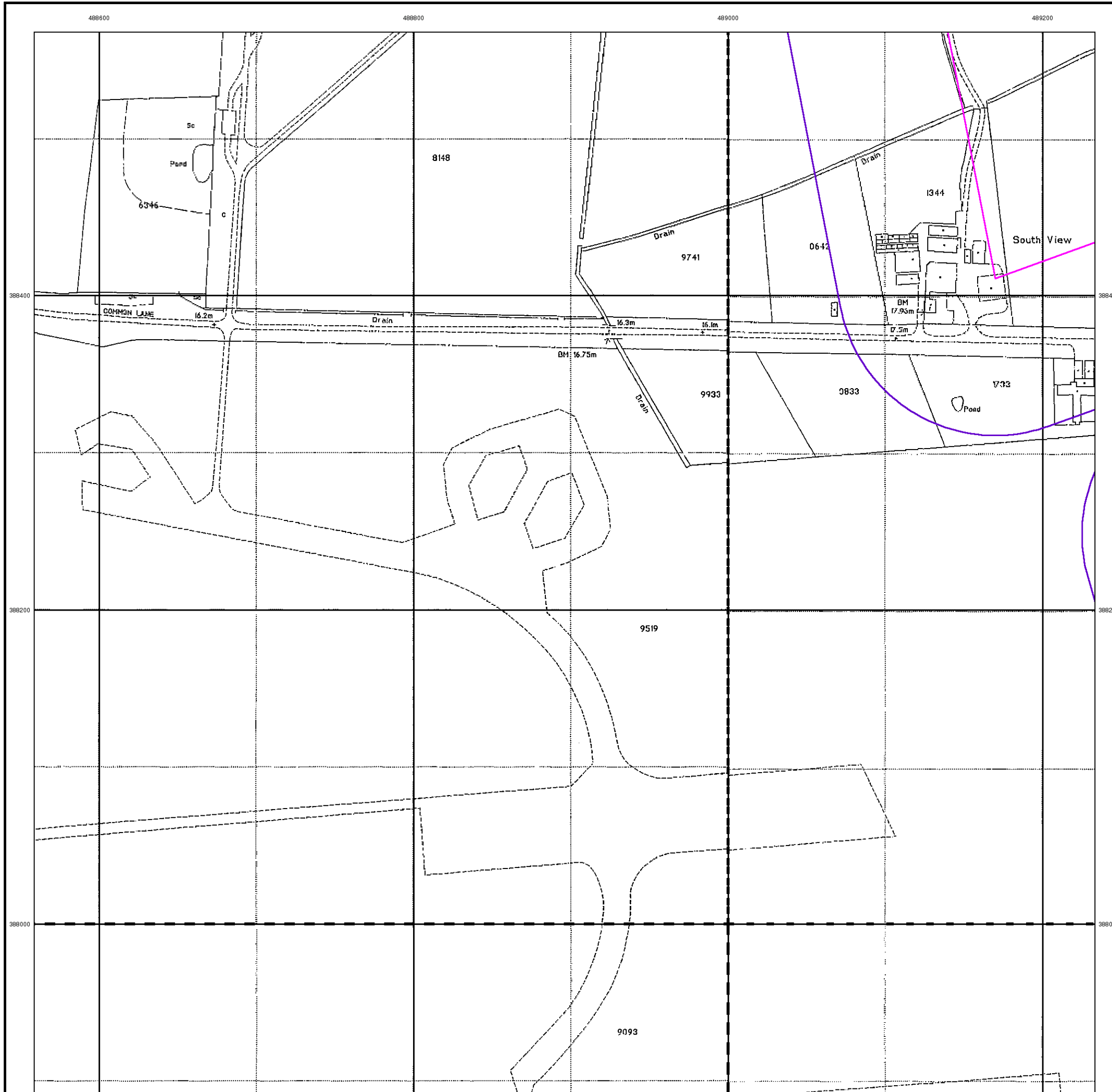

Historical Mapping Legends

Ordnance Survey County Series and Ordnance Survey Plan 1:2,500

Quarry **Gravel Pit** **Sand Pit**
Clay Pit **Shingle** **Refuse Heap**
Sloping Masonry **Flat Rock**
Marsh **Reeds** **Osiers**
Rough Pasture **Furze** **Wood**
Mixed Wood **Brushwood** **Orchard**
Fir **Ford** **Stepping Stones**
Ferry **Waterfall** **Lock**
Trig. Station **Altitude at Trig. Station**
B.M. 325.9 **Bench Mark** **Surface Level**
Arrow denotes flow of water **Antiquities (site of)**
Cutting **Embankment**
Railway crossing Road **Level Crossing** **Road crossing Railway**
Railway crossing River or Canal **Road over single stream** **Road over River or Canal**
County Boundary (Geographical)
County & Civil Parish Boundary
Administrative County & Civil Parish Boundary
County Borough Boundary (England)
Co. Boro. Bdy.
County Burgh Boundary (Scotland)
Co. Burgh Bdy.
BP BS Boundary Post or Stone **P.C.B** Police Call Box
B.R. Bridle Road **P** Pump
E.P Electricity Pylon **S.P** Signal Post
F.B. Foot Bridge **SL** Sluice
F.P. Foot Path **Sp.** Spring
G.P Guide Post or Board **T.C.B** Telephone Call Box
M.S Mile Stone **Tr.** Trough
M.P M.R Mooring Post or Ring **W** Well

Ordnance Survey Plan, Additional SIMs and Supply of Unpublished Survey Information 1:2,500 and 1:1,250

Inactive Quarry, Chalk Pit or Clay Pit **Active Quarry, Chalk Pit or Clay Pit**
Rock **Boulders**
Cliff **Slopes** **Top**
Roofed Building **Glazed Roof Building**
Sloping Masonry **Archway**
Non-Coniferous Tree (surveyed) **Coniferous Tree (surveyed)**
Non-Coniferous Trees (not surveyed) **Coniferous Trees (not surveyed)**
Orchard Tree **Scrub** **Bracken**
Coppice, Osier **Reeds** **Marsh, Saltings**
Rough Grassland **Heath** **Culvert**
Direction of water flow **Bench Mark** **Antiquity (site of)**
Cave Entrance **Triangulation Station** **Electricity Pylon**
Electricity Transmission Line
County Boundary (Geographical)
County & Civil Parish Boundary
Civil Parish Boundary
Admin. County or County Bor. Boundary
London Borough Boundary
Symbol marking point where boundary mereing changes
BH Beer House **P** Pillar, Pole or Post
BP, BS Boundary Post or Stone **PO** Post Office
Cn, C Capstan, Crane **PC** Public Convenience
Chy Chimney **PH** Public House
D Fn Drinking Fountain **Pp** Pump
EI P Electricity Pillar or Post **SB, S Br** Signal Box or Bridge
FAP Fire Alarm Pillar **SP, SL** Signal Post or Light
FB Foot Bridge **Spr** Spring
GP Guide Post **Tk** Tank or Track
H Hydrant or Hydraulic **TCB** Telephone Call Box
LC Level Crossing **TCP** Telephone Call Post
MH Manhole **Tr** Trough
MP Mile Post or Mooring Post **Wr Pt, Wr T** Water Point, Water Tap
MS Mile Stone **W** Well
NTL Normal Tidal Limit **Wd Pp** Wind Pump

Large-Scale National Grid Data 1:2,500 and 1:1,250

Cliff **Slopes** **Top**
Rock **Rock (scattered)**
Boulders **Boulders (scattered)**
Positioned Boulder **Scree**
Non-Coniferous Tree (surveyed) **Coniferous Tree (surveyed)**
Non-Coniferous Trees (not surveyed) **Coniferous Trees (not surveyed)**
Orchard Tree **Scrub** **Bracken**
Coppice, Osier **Reeds** **Marsh, Saltings**
Rough Grassland **Heath** **Culvert**
Direction of water flow **Triangulation Station** **Antiquity (site of)**
Electricity Transmission Line **Electricity Pylon**
BM 231.60m Bench Mark **Buildings with Building Seed**
Roofed Building **Glazed Roof Building**
Civil parish/community boundary
District boundary
County boundary
Boundary post/stone
Boundary mereing symbol (note: these always appear in opposed pairs or groups of three)
Bks Barracks **P** Pillar, Pole or Post
Bty Battery **PO** Post Office
Cemy Cemetery **PC** Public Convenience
Chy Chimney **Pp** Pump
Cis Cistern **Ppg Sta** Pumping Station
Dismtd Rly Dismantled Railway **PW** Place of Worship
EI Gen Sta Electricity Generating Station **Sewage Ppg Sta** Sewage Pumping Station
EI P Electricity Pole, Pillar **SB, S Br** Signal Box or Bridge
EI Sub Sta Electricity Sub Station **SP, SL** Signal Post or Light
FB Filter Bed **Spr** Spring
Fn / D Fn Fountain / Drinking Ftn. **Tk** Tank or Track
Gas Gov Gas Valve Compound **Tr** Trough
GVC Gas Governor **Wd Pp** Wind Pump
GP Guide Post **Wr Pt, Wr T** Water Point, Water Tap
MH Manhole **Wks** Works (building or area)
MP, MS Mile Post or Mile Stone **W** Well



Historical Mapping & Photography included:

Mapping Type	Scale	Date	Pg
Lincolnshire	1:2,500	1886	2
Lincolnshire	1:2,500	1906	3
Ordnance Survey Plan	1:2,500	1972 - 1973	4
Large-Scale National Grid Data	1:2,500	1994	5

Historical Map - Segment E10

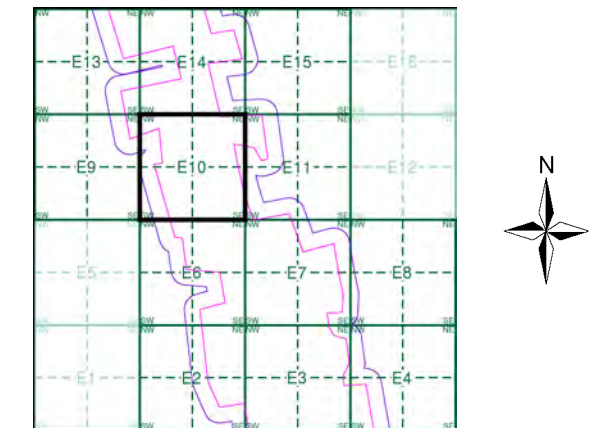

Order Details

Order Number: 297990273_1_1
 Customer Ref: 21-1088.04
 National Grid Reference: 489860, 387850
 Slice: E
 Site Area (Ha): 469.98
 Search Buffer (m): 100

Site Details

Cottam



Tel: [Redacted]
 Fax: [Redacted]
 Web: [Redacted]

Lincolnshire
Published 1886

Source map scale - 1:2,500

The historical maps shown were reproduced from maps predominantly held at the scale adopted for England, Wales and Scotland in the 1840's. In 1854 the 1:2,500 scale was adopted for mapping urban areas and by 1896 it covered the whole of what were considered to be the cultivated parts of Great Britain. The published date given below is often some years later than the surveyed date. Before 1938, all OS maps were based on the Cassini Projection, with independent surveys of a single county or group of counties, giving rise to significant inaccuracies in outlying areas.

Map Name(s) and Date(s)

043_11 1886 1:2,500	043_12 1886 1:2,500
043_15 1886 1:2,500	043_16 1886 1:2,500

Historical Map - Segment E10

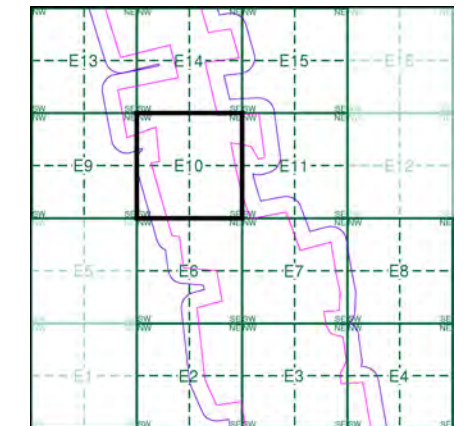

Order Details

Order Number: 297990273_1_1
 Customer Ref: 21-1088.04
 National Grid Reference: 489860, 387850
 Slice: E
 Site Area (Ha): 469.98
 Search Buffer (m): 100

Site Details

Cottam

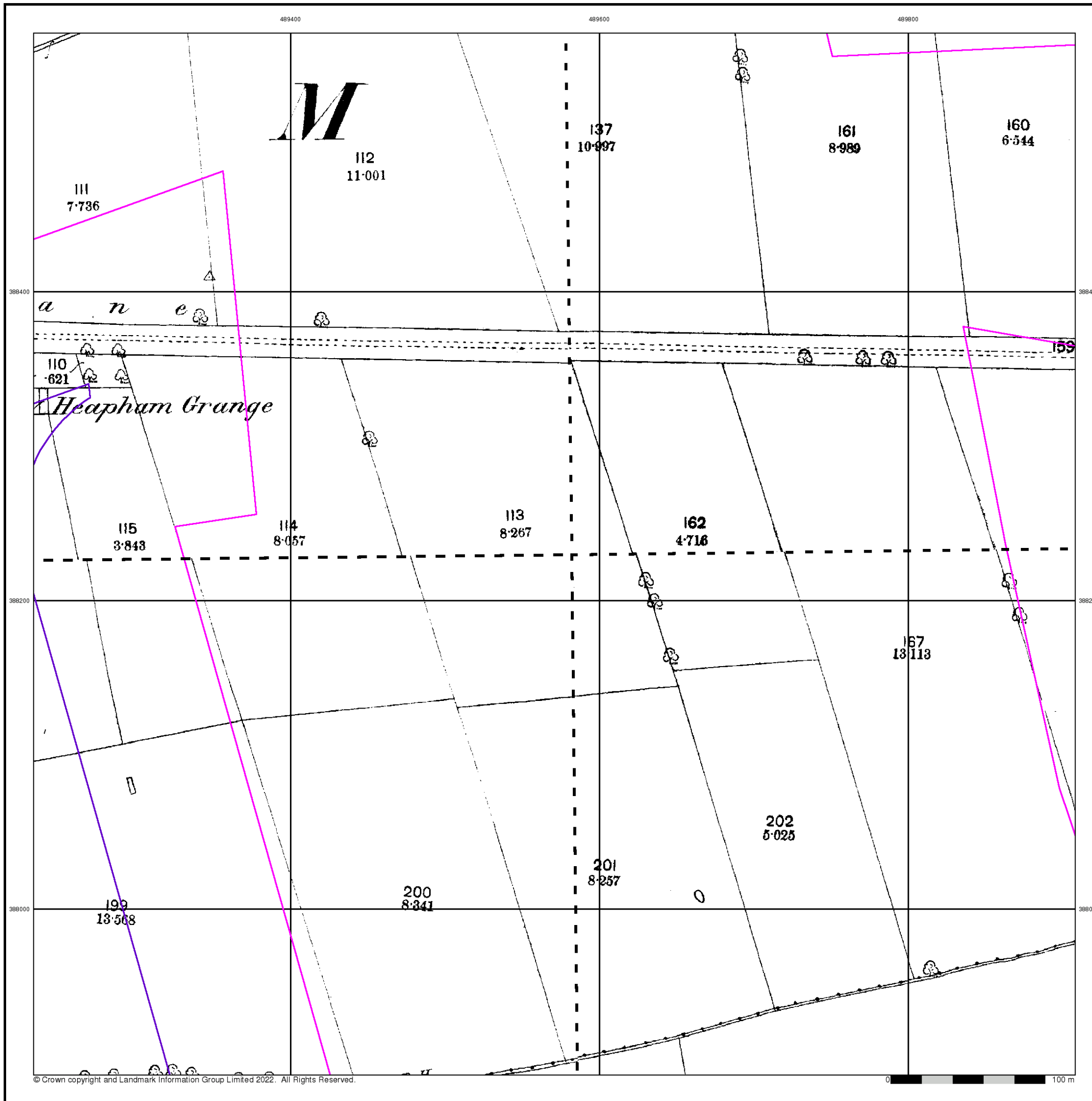

Lincolnshire

Published 1906

Source map scale - 1:2,500

The historical maps shown were reproduced from maps predominantly held at the scale adopted for England, Wales and Scotland in the 1840's. In 1854 the 1:2,500 scale was adopted for mapping urban areas and by 1896 it covered the whole of what were considered to be the cultivated parts of Great Britain. The published date given below is often some years later than the surveyed date. Before 1938, all OS maps were based on the Cassini Projection, with independent surveys of a single county or group of counties, giving rise to significant inaccuracies in outlying areas.

Map Name(s) and Date(s)

043_11 1906 1:2,500	043_12 1906 1:2,500
043_15 1906 1:2,500	043_16 1906 1:2,500

Historical Map - Segment E10

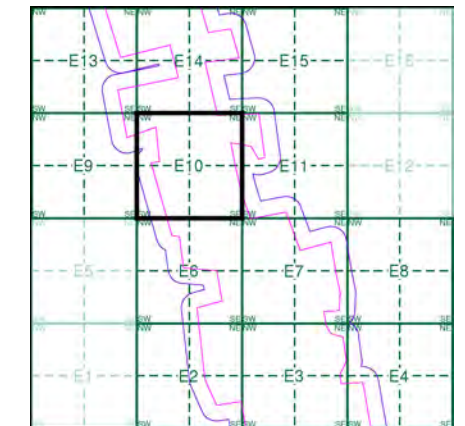

Order Details

Order Number: 297990273_1_1
 Customer Ref: 21-1088.04
 National Grid Reference: 489860, 387850
 Slice: E
 Site Area (Ha): 469.98
 Search Buffer (m): 100

Site Details

Cottam

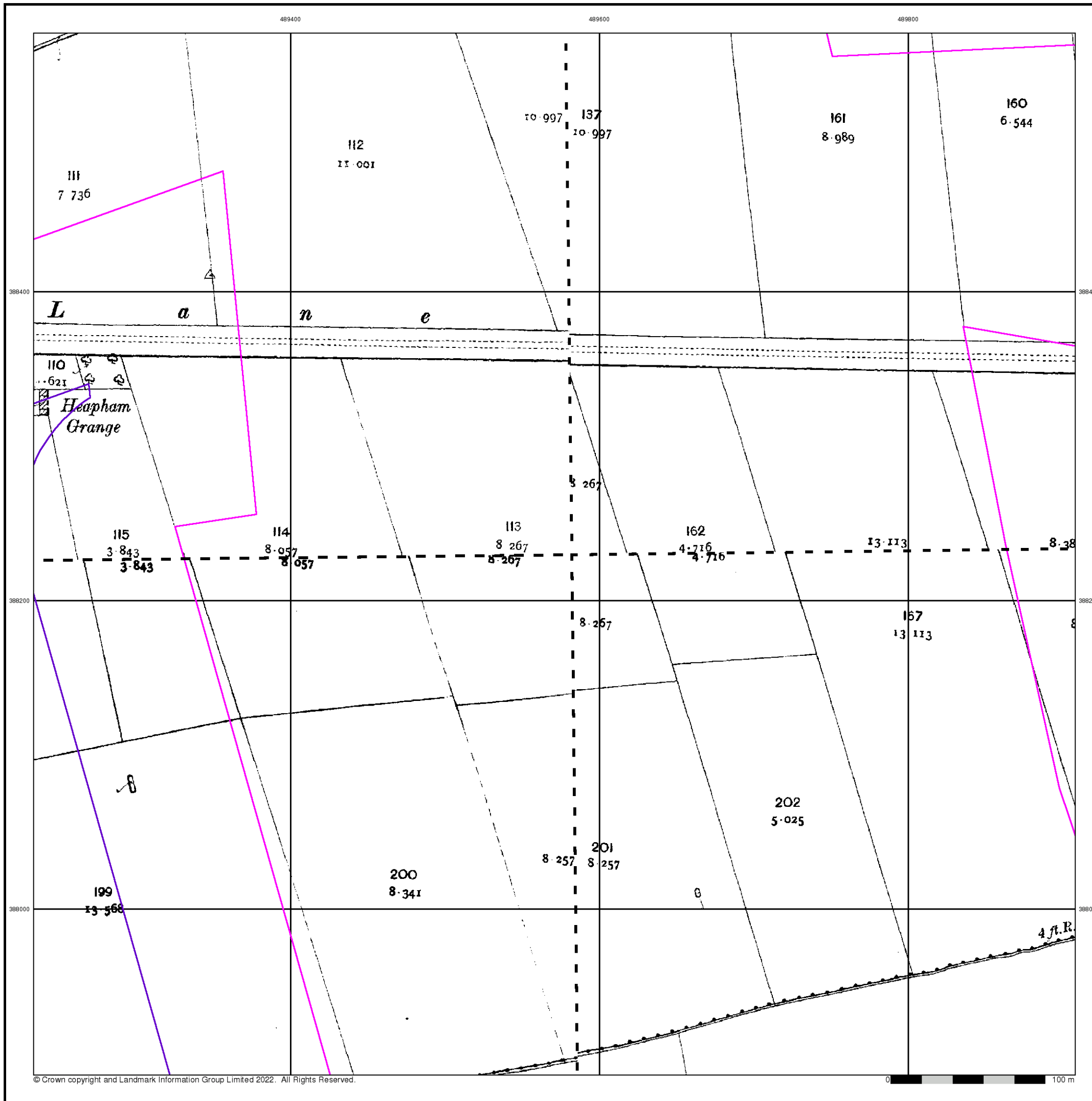

Ordnance Survey Plan
Published 1972 - 1973
Source map scale - 1:2,500

The historical maps shown were reproduced from maps predominantly held at the scale adopted for England, Wales and Scotland in the 1840's. In 1854 the 1:2,500 scale was adopted for mapping urban areas and by 1896 it covered the whole of what were considered to be the cultivated parts of Great Britain. The published date given below is often some years later than the surveyed date. Before 1938, all OS maps were based on the Cassini Projection, with independent surveys of a single county or group of counties, giving rise to significant inaccuracies in outlying areas.

Map Name(s) and Date(s)

SK8988	1972	1:2,500
SK8987	1973	1:2,500

Historical Map - Segment E10

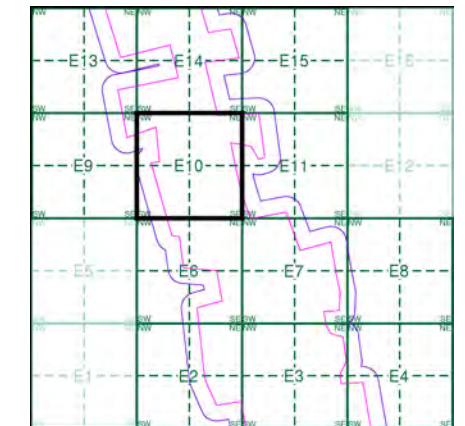

Order Details

Order Number: 297990273_1_1
 Customer Ref: 21-1088.04
 National Grid Reference: 489860, 387850
 Slice: E
 Site Area (Ha): 469.98
 Search Buffer (m): 100

Site Details

Cottam

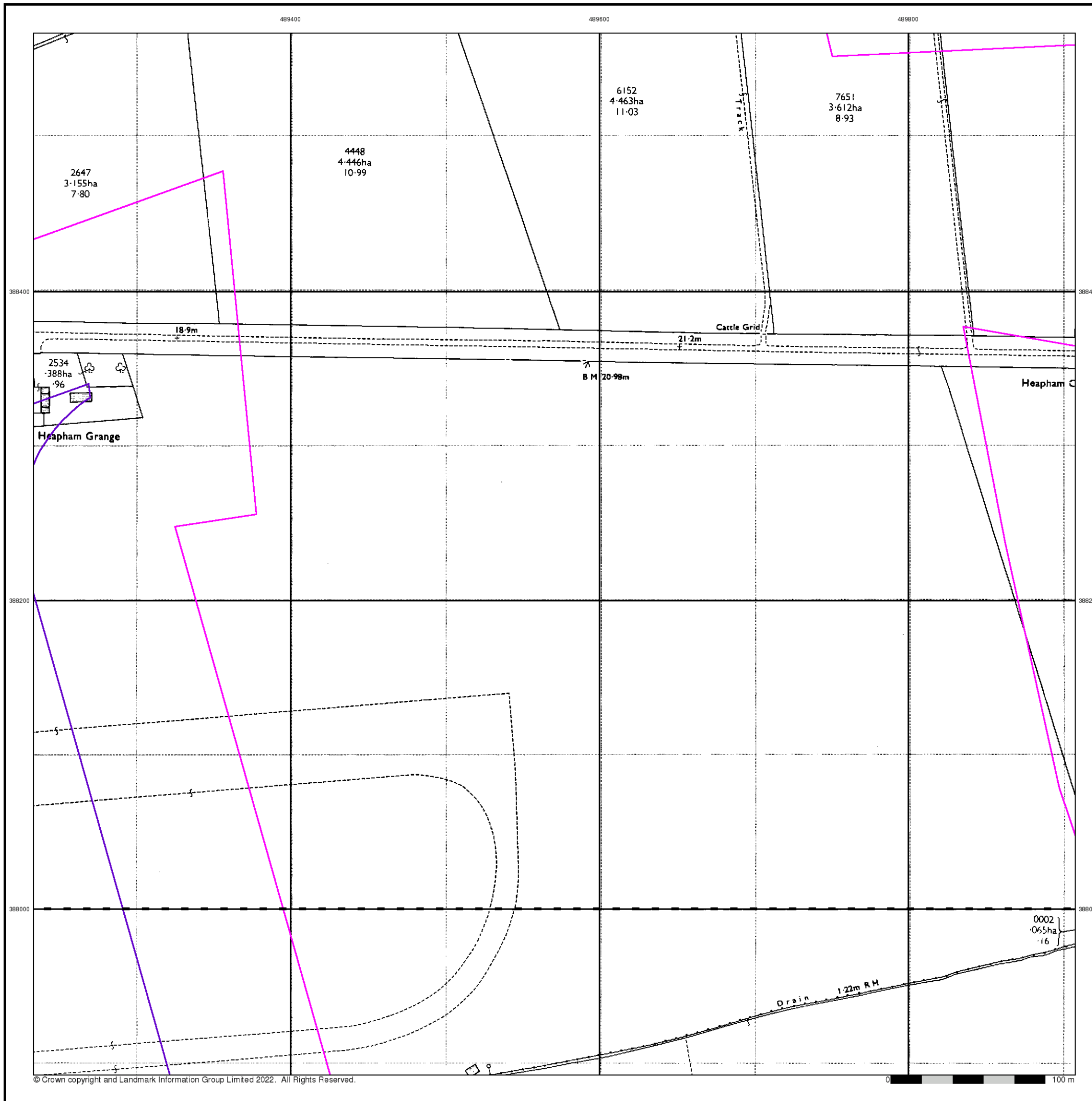

Large-Scale National Grid Data

Published 1994

Source map scale - 1:2,500

'Large Scale National Grid Data' superseded SIM cards (Ordnance Survey's 'Survey of Information on Microfilm') in 1992, and continued to be produced until 1999. These maps were the fore-runners of digital mapping and so provide detailed information on houses and roads, but tend to show less topographic features such as vegetation. These maps were produced at both 1:2,500 and 1:1,250 scales.

Map Name(s) and Date(s)

SK8988	1994	1:2,500
SK8987	1994	1:2,500

Historical Map - Segment E10

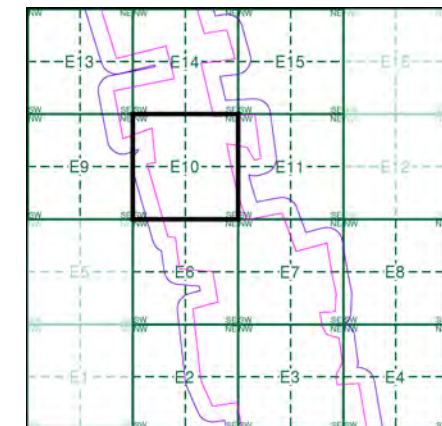

Order Details

Order Number: 297990273_1_1
 Customer Ref: 21-1088.04
 National Grid Reference: 489860, 387850
 Slice: E
 Site Area (Ha): 469.98
 Search Buffer (m): 100

Site Details

Cottam

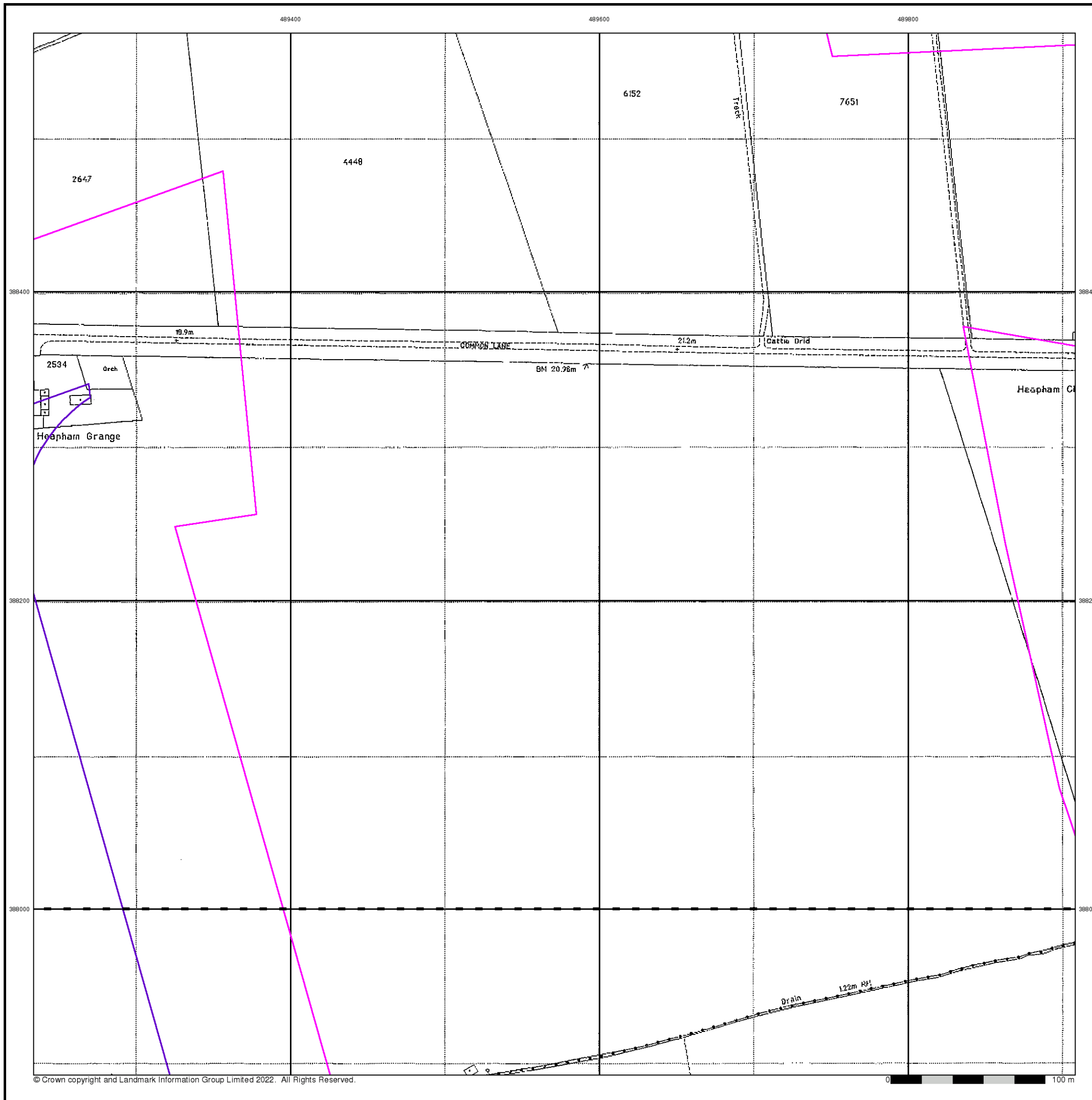

Historical Mapping Legends

Ordnance Survey County Series and Ordnance Survey Plan 1:2,500

Quarry **Gravel Pit** **Sand Pit**
Clay Pit **Shingle** **Refuse Heap**
Sloping Masonry **Flat Rock**
Marsh **Reeds** **Osiers**
Rough Pasture **Furze** **Wood**
Mixed Wood **Brushwood** **Orchard**
Fir **Ford** **Stepping Stones**
Ferry **Waterfall** **Lock**
Trig. Station **Altitude at Trig. Station**
B.M. 325.9 **Bench Mark** **Surface Level**
Arrow denotes flow of water **Antiquities (site of)**
Cutting **Embankment**
Railway crossing Road **Level Crossing** **Road crossing Railway**
Railway crossing River or Canal **Road over single stream** **Road over River or Canal**
County Boundary (Geographical)
County & Civil Parish Boundary
Administrative County & Civil Parish Boundary
County Borough Boundary (England)
Co. Boro. Bdy.
County Burgh Boundary (Scotland)
Co. Burgh Bdy.
BP BS Boundary Post or Stone **P.C.B** Police Call Box
B.R. Bridle Road **P** Pump
E.P Electricity Pylon **S.P** Signal Post
F.B. Foot Bridge **SL** Sluice
F.P. Foot Path **Sp.** Spring
G.P Guide Post or Board **T.C.B** Telephone Call Box
M.S Mile Stone **Tr.** Trough
M.P M.R Mooring Post or Ring **W** Well

Ordnance Survey Plan, Additional SIMs and Supply of Unpublished Survey Information 1:2,500 and 1:1,250

Inactive Quarry, Chalk Pit or Clay Pit **Active Quarry, Chalk Pit or Clay Pit**
Rock **Boulders**
Cliff **Slopes** **Top**
Roofed Building **Glazed Roof Building**
Sloping Masonry **Archway**
Non-Coniferous Tree (surveyed) **Coniferous Tree (surveyed)**
Non-Coniferous Trees (not surveyed) **Coniferous Trees (not surveyed)**
Orchard Tree **Scrub** **Bracken**
Coppice, Osier **Reeds** **Marsh, Saltings**
Rough Grassland **Heath** **Culvert**
Direction of water flow **Bench Mark** **Antiquity (site of)**
Cave Entrance **Triangulation Station** **Electricity Pylon**
Electricity Transmission Line
County Boundary (Geographical)
County & Civil Parish Boundary
Civil Parish Boundary
Admin. County or County Bor. Boundary
London Borough Boundary
Symbol marking point where boundary mereing changes
BH Beer House **P** Pillar, Pole or Post
BP, BS Boundary Post or Stone **PO** Post Office
Cn, C Capstan, Crane **PC** Public Convenience
Chy Chimney **PH** Public House
D Fn Drinking Fountain **Pp** Pump
EI P Electricity Pillar or Post **SB, S Br** Signal Box or Bridge
FAP Fire Alarm Pillar **SP, SL** Signal Post or Light
FB Foot Bridge **Spr** Spring
GP Guide Post **Tk** Tank or Track
H Hydrant or Hydraulic **TCB** Telephone Call Box
LC Level Crossing **TCP** Telephone Call Post
MH Manhole **Tr** Trough
MP Mile Post or Mooring Post **Wr Pt, Wr T** Water Point, Water Tap
MS Mile Stone **W** Well
NTL Normal Tidal Limit **Wd Pp** Wind Pump

Large-Scale National Grid Data 1:2,500 and 1:1,250

Cliff **Slopes** **Top**
Rock **Rock (scattered)**
Boulders **Boulders (scattered)**
Positioned Boulder **Scree**
Non-Coniferous Tree (surveyed) **Coniferous Tree (surveyed)**
Non-Coniferous Trees (not surveyed) **Coniferous Trees (not surveyed)**
Orchard Tree **Scrub** **Bracken**
Coppice, Osier **Reeds** **Marsh, Saltings**
Rough Grassland **Heath** **Culvert**
Direction of water flow **Triangulation Station** **Antiquity (site of)**
Electricity Transmission Line **Electricity Pylon**
BM 231.60m Bench Mark **Buildings with Building Seed**
Roofed Building **Glazed Roof Building**
Civil parish/community boundary
District boundary
County boundary
Boundary post/stone
Boundary mereing symbol (note: these always appear in opposed pairs or groups of three)
Bks Barracks **P** Pillar, Pole or Post
Bty Battery **PO** Post Office
Cemy Cemetery **PC** Public Convenience
Chy Chimney **Pp** Pump
Cis Cistern **Ppg Sta** Pumping Station
Dismtd Rly Dismantled Railway **PW** Place of Worship
EI Gen Sta Electricity Generating Station **Sewage Ppg Sta** Sewage Pumping Station
EI P Electricity Pole, Pillar **SB, S Br** Signal Box or Bridge
EI Sub Sta Electricity Sub Station **SP, SL** Signal Post or Light
FB Filter Bed **Spr** Spring
Fn / D Fn Fountain / Drinking Ftn. **Tk** Tank or Track
Gas Gov Gas Valve Compound **Tr** Trough
GVC Gas Governor **Wd Pp** Wind Pump
GP Guide Post **Wr Pt, Wr T** Water Point, Water Tap
MH Manhole **Wks** Works (building or area)
MP, MS Mile Post or Mile Stone **W** Well



Historical Mapping & Photography included:

Mapping Type	Scale	Date	Pg
Lincolnshire	1:2,500	1886	2
Lincolnshire	1:2,500	1906	3
Ordnance Survey Plan	1:2,500	1972 - 1974	4
Large-Scale National Grid Data	1:2,500	1994	5

Historical Map - Segment E11

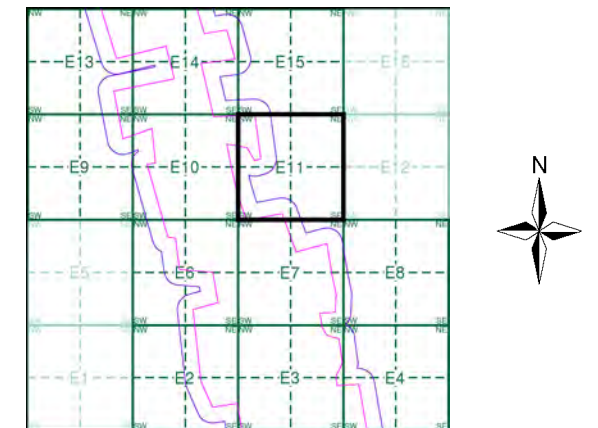

Order Details

Order Number: 297990273_1_1
 Customer Ref: 21-1088.04
 National Grid Reference: 489860, 387850
 Slice: E
 Site Area (Ha): 469.98
 Search Buffer (m): 100

Site Details

Cottam



Tel: [Redacted]
 Fax: [Redacted]
 Web: [Redacted]

Lincolnshire

Published 1886

Source map scale - 1:2,500

The historical maps shown were reproduced from maps predominantly held at the scale adopted for England, Wales and Scotland in the 1840's. In 1854 the 1:2,500 scale was adopted for mapping urban areas and by 1896 it covered the whole of what were considered to be the cultivated parts of Great Britain. The published date given below is often some years later than the surveyed date. Before 1938, all OS maps were based on the Cassini Projection, with independent surveys of a single county or group of counties, giving rise to significant inaccuracies in outlying areas.

Map Name(s) and Date(s)

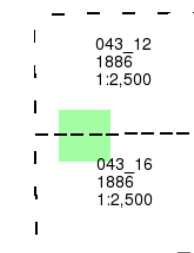

Historical Map - Segment E11

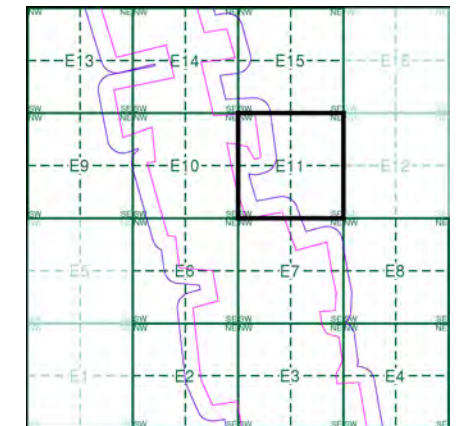

Order Details

Order Number: 297990273_1_1
 Customer Ref: 21-1088.04
 National Grid Reference: 489860, 387850
 Slice: E
 Site Area (Ha): 469.98
 Search Buffer (m): 100

Site Details

Cottam

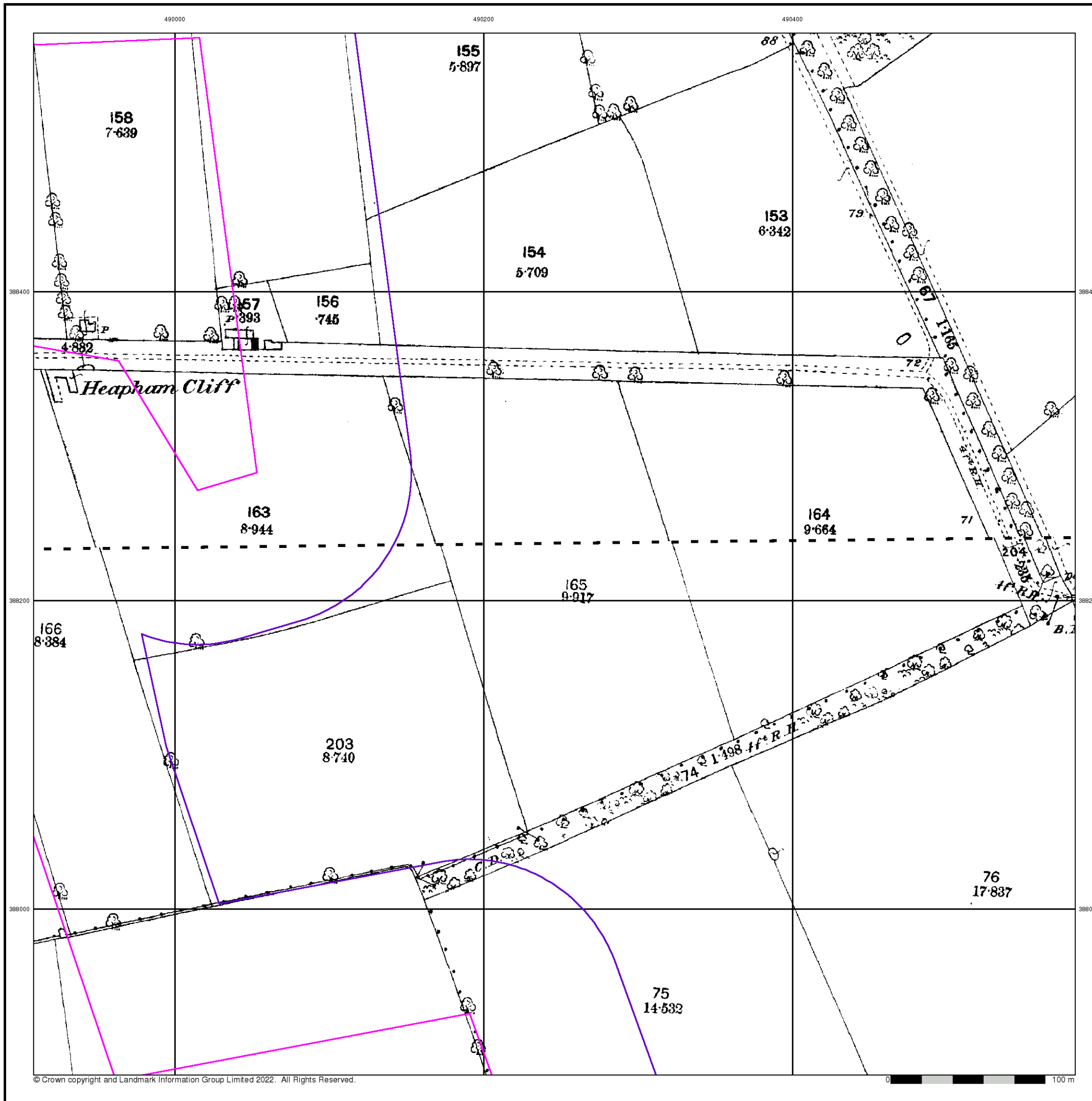

Lincolnshire

Published 1906

Source map scale - 1:2,500

The historical maps shown were reproduced from maps predominantly held at the scale adopted for England, Wales and Scotland in the 1840's. In 1854 the 1:2,500 scale was adopted for mapping urban areas and by 1896 it covered the whole of what were considered to be the cultivated parts of Great Britain. The published date given below is often some years later than the surveyed date. Before 1938, all OS maps were based on the Cassini Projection, with independent surveys of a single county or group of counties, giving rise to significant inaccuracies in outlying areas.

Map Name(s) and Date(s)

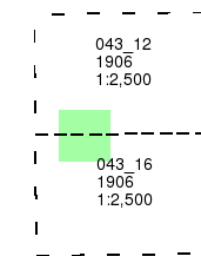

Historical Map - Segment E11

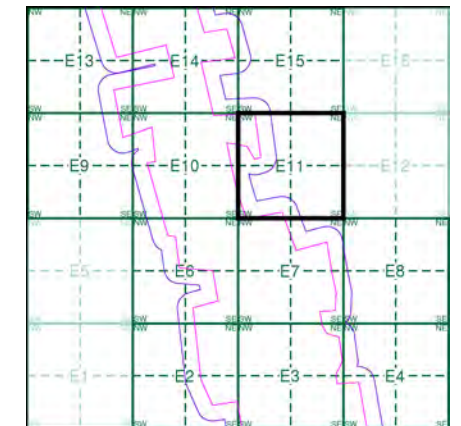

Order Details

Order Number: 297990273_1_1
 Customer Ref: 21-1088.04
 National Grid Reference: 489860, 387850
 Slice: E
 Site Area (Ha): 469.98
 Search Buffer (m): 100

Site Details

Cottam

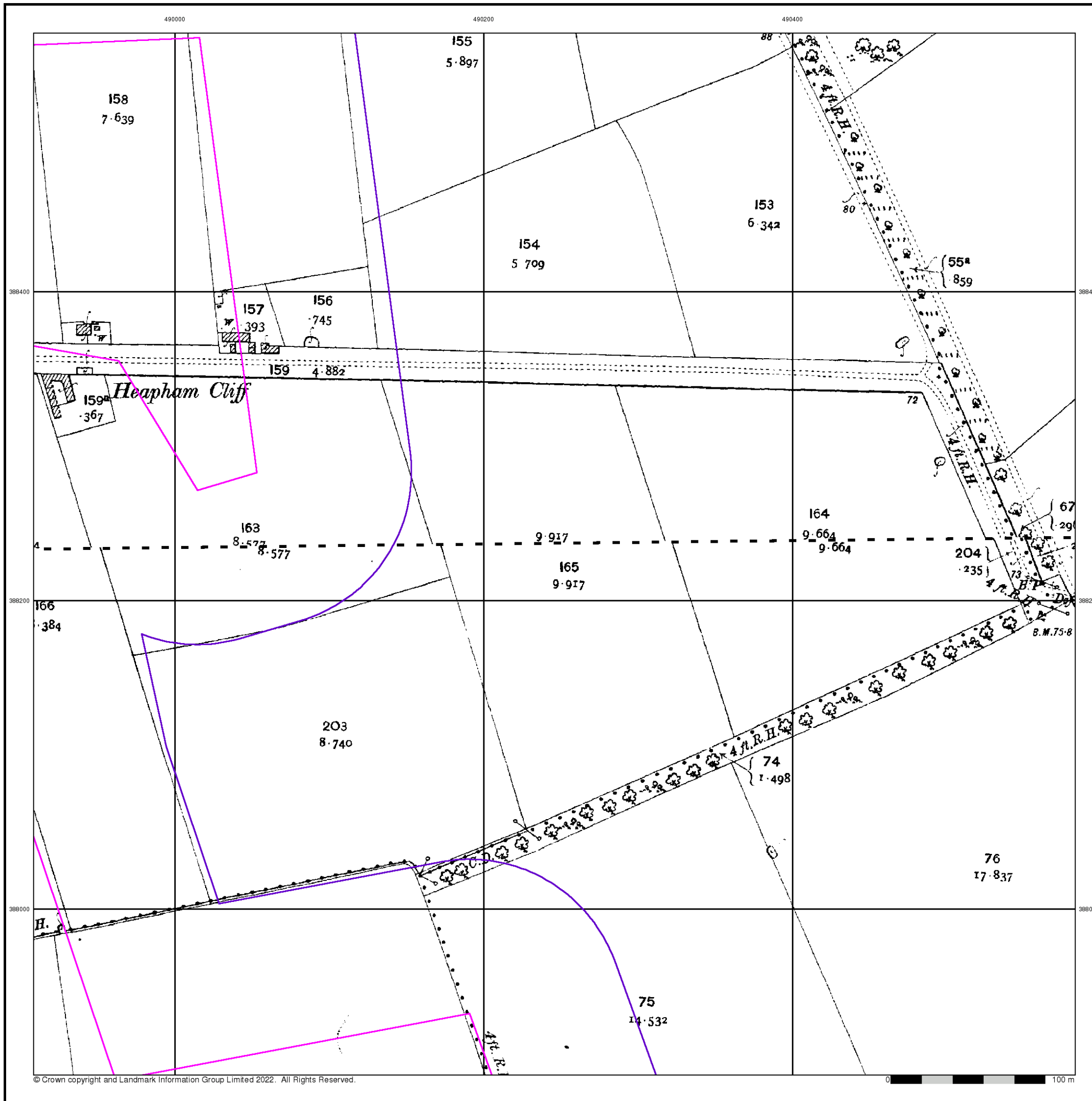

Large-Scale National Grid Data

Published 1994

Source map scale - 1:2,500

'Large Scale National Grid Data' superseded SIM cards (Ordnance Survey's 'Survey of Information on Microfilm') in 1992, and continued to be produced until 1999. These maps were the fore-runners of digital mapping and so provide detailed information on houses and roads, but tend to show less topographic features such as vegetation. These maps were produced at both 1:2,500 and 1:1,250 scales.

Map Name(s) and Date(s)

SK8988 1994 1:2,500	SK9088 1994 1:2,500
SK8987 1994 1:2,500	SK9087 1994 1:2,500

Historical Map - Segment E11

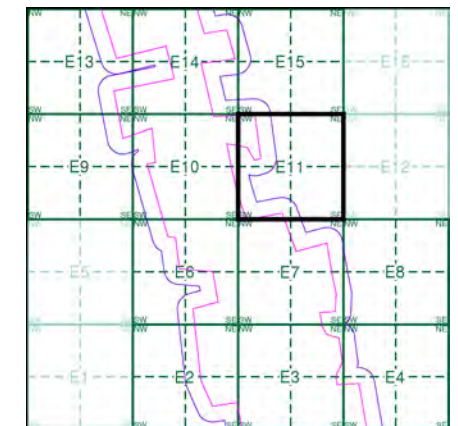

Order Details

Order Number: 297990273_1_1
 Customer Ref: 21-1088.04
 National Grid Reference: 489860, 387850
 Slice: E
 Site Area (Ha): 469.98
 Search Buffer (m): 100

Site Details

Cottam

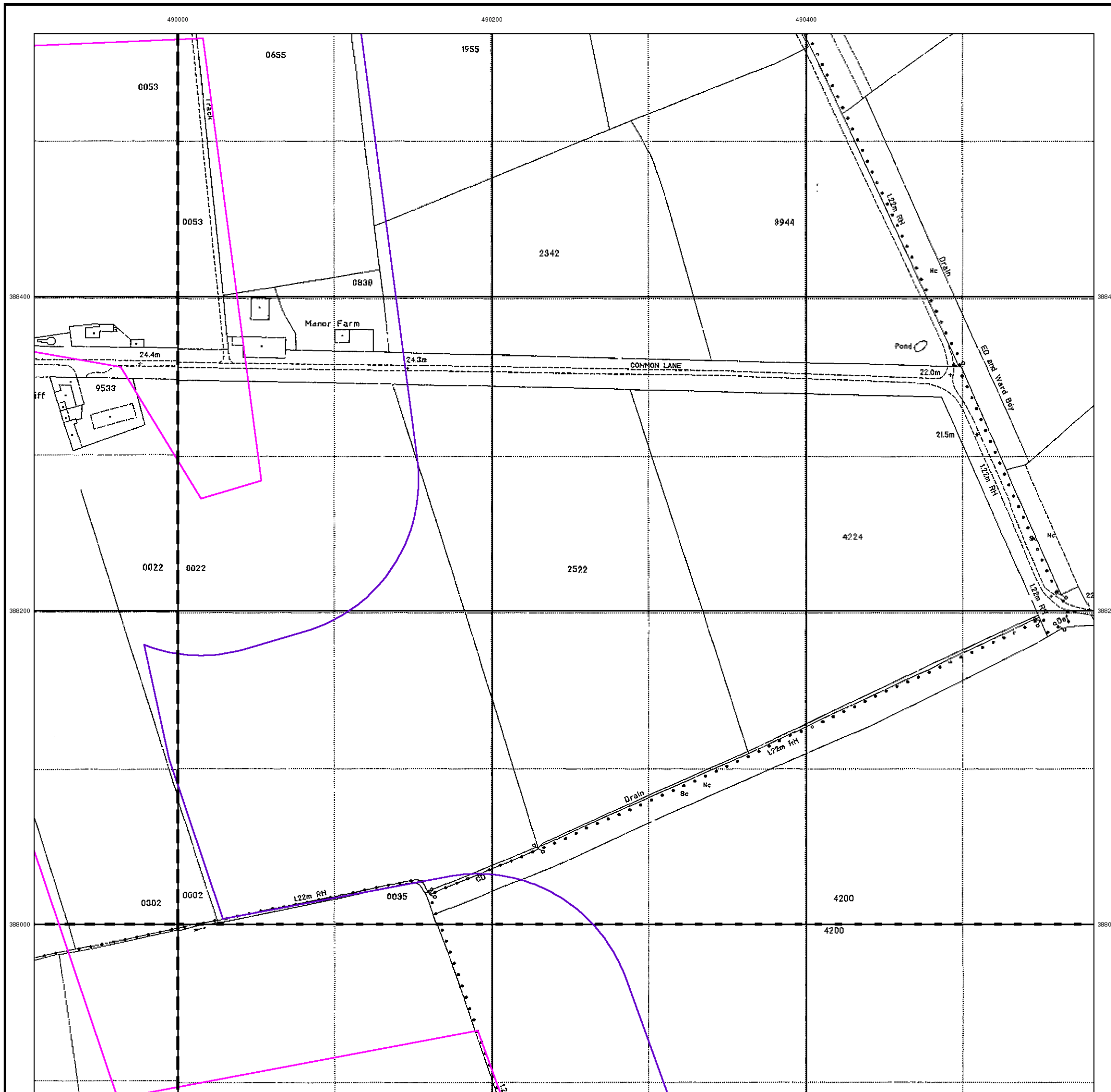

Historical Mapping Legends

Ordnance Survey County Series and Ordnance Survey Plan 1:2,500

Quarry **Gravel Pit** **Sand Pit**
Clay Pit **Shingle** **Refuse Heap**
Sloping Masonry **Flat Rock**
Marsh **Reeds** **Osiers**
Rough Pasture **Furze** **Wood**
Mixed Wood **Brushwood** **Orchard**
Fir **Ford** **Stepping Stones**
Ferry **Waterfall** **Lock**
Trig. Station **Altitude at Trig. Station**
B.M. 325.9 **Bench Mark** **Surface Level**
Arrow denotes flow of water **Antiquities (site of)**
Cutting **Embankment**
Railway crossing Road **Level Crossing** **Road crossing Railway**
Railway crossing River or Canal **Road over single stream** **Road over River or Canal**
County Boundary (Geographical)
County & Civil Parish Boundary
Administrative County & Civil Parish Boundary
County Borough Boundary (England)
County Burgh Boundary (Scotland)
Co. Boro. Bdy.
Co. Burgh Bdy.
BP BS Boundary Post or Stone **P.C.B** Police Call Box
B.R. Bridle Road **P** Pump
E.P Electricity Pylon **S.P** Signal Post
F.B. Foot Bridge **SL** Sluice
F.P. Foot Path **Sp.** Spring
G.P Guide Post or Board **T.C.B** Telephone Call Box
M.S Mile Stone **Tr.** Trough
M.P M.R Mooring Post or Ring **W** Well

Ordnance Survey Plan, Additional SIMs and Supply of Unpublished Survey Information 1:2,500 and 1:1,250

Inactive Quarry, Chalk Pit or Clay Pit **Active Quarry, Chalk Pit or Clay Pit**
Rock **Boulders**
Cliff **Slopes** **Top**
Roofed Building **Glazed Roof Building**
Sloping Masonry **Archway**
Non-Coniferous Tree (surveyed) **Coniferous Tree (surveyed)**
Non-Coniferous Trees (not surveyed) **Coniferous Trees (not surveyed)**
Orchard Tree **Scrub** **Bracken**
Coppice, Osier **Reeds** **Marsh, Saltings**
Rough Grassland **Heath** **Culvert**
Direction of water flow **Bench Mark** **Antiquity (site of)**
Cave Entrance **Triangulation Station** **Electricity Pylon**
Electricity Transmission Line
County Boundary (Geographical)
County & Civil Parish Boundary
Civil Parish Boundary
Admin. County or County Bor. Boundary
London Borough Boundary
Symbol marking point where boundary mereing changes
BH Beer House **P** Pillar, Pole or Post
BP, BS Boundary Post or Stone **PO** Post Office
Cn, C Capstan, Crane **PC** Public Convenience
Chy Chimney **PH** Public House
D Fn Drinking Fountain **Pp** Pump
EI P Electricity Pillar or Post **SB, S Br** Signal Box or Bridge
FAP Fire Alarm Pillar **SP, SL** Signal Post or Light
FB Foot Bridge **Spr** Spring
GP Guide Post **Tk** Tank or Track
H Hydrant or Hydraulic **TCB** Telephone Call Box
LC Level Crossing **TCP** Telephone Call Post
MH Manhole **Tr** Trough
MP Mile Post or Mooring Post **Wr Pt, Wr T** Water Point, Water Tap
MS Mile Stone **W** Well
NTL Normal Tidal Limit **Wd Pp** Wind Pump

Large-Scale National Grid Data 1:2,500 and 1:1,250

Cliff **Slopes** **Top**
Rock **Rock (scattered)**
Boulders **Boulders (scattered)**
Positioned Boulder **Scree**
Non-Coniferous Tree (surveyed) **Coniferous Tree (surveyed)**
Non-Coniferous Trees (not surveyed) **Coniferous Trees (not surveyed)**
Orchard Tree **Scrub** **Bracken**
Coppice, Osier **Reeds** **Marsh, Saltings**
Rough Grassland **Heath** **Culvert**
Direction of water flow **Triangulation Station** **Antiquity (site of)**
Electricity Transmission Line **Electricity Pylon**
BM 231.60m Bench Mark **Buildings with Building Seed**
Roofed Building **Glazed Roof Building**
Civil parish/community boundary
District boundary
County boundary
Boundary post/stone
Boundary mereing symbol (note: these always appear in opposed pairs or groups of three)
Bks Barracks **P** Pillar, Pole or Post
Bty Battery **PO** Post Office
Cemy Cemetery **PC** Public Convenience
Chy Chimney **Pp** Pump
Cis Cistern **Ppg Sta** Pumping Station
Dismtd Rly Dismantled Railway **PW** Place of Worship
EI Gen Sta Electricity Generating Station **Sewage Ppg Sta** Sewage Pumping Station
EI P Electricity Pole, Pillar **SB, S Br** Signal Box or Bridge
EI Sub Sta Electricity Sub Station **SP, SL** Signal Post or Light
FB Filter Bed **Spr** Spring
Fn / D Fn Fountain / Drinking Ftn. **Tk** Tank or Track
Gas Gov Gas Valve Compound **Tr** Trough
GVC Gas Governor **Wd Pp** Wind Pump
GP Guide Post **Wr Pt, Wr T** Water Point, Water Tap
MH Manhole **Wks** Works (building or area)
MP, MS Mile Post or Mile Stone **W** Well



Historical Mapping & Photography included:

Mapping Type	Scale	Date	Pg
Lincolnshire	1:2,500	1886	2
Lincolnshire	1:2,500	1906	3
Ordnance Survey Plan	1:2,500	1972	4
Large-Scale National Grid Data	1:2,500	1994	5

Historical Map - Segment E13

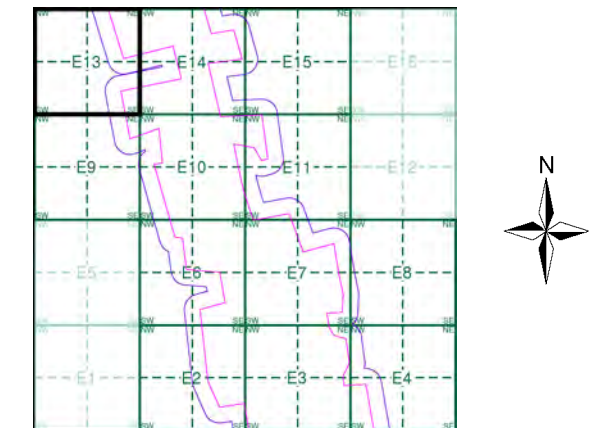

Order Details

Order Number: 297990273_1_1
 Customer Ref: 21-1088.04
 National Grid Reference: 489860, 387850
 Slice: E
 Site Area (Ha): 469.98
 Search Buffer (m): 100

Site Details

Cottam



Tel: [Redacted]
 Fax: [Redacted]
 Web: [Redacted]

Lincolnshire
Published 1886

Source map scale - 1:2,500

The historical maps shown were reproduced from maps predominantly held at the scale adopted for England, Wales and Scotland in the 1840's. In 1854 the 1:2,500 scale was adopted for mapping urban areas and by 1896 it covered the whole of what were considered to be the cultivated parts of Great Britain. The published date given below is often some years later than the surveyed date. Before 1938, all OS maps were based on the Cassini Projection, with independent surveys of a single county or group of counties, giving rise to significant inaccuracies in outlying areas.

Map Name(s) and Date(s)

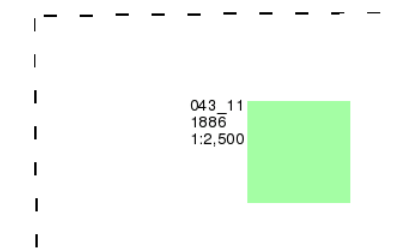

Historical Map - Segment E13

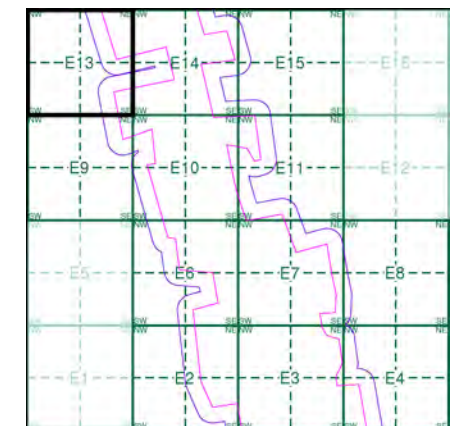

Order Details

Order Number: 297990273_1_1
 Customer Ref: 21-1088.04
 National Grid Reference: 489860, 387850
 Slice: E
 Site Area (Ha): 469.98
 Search Buffer (m): 100

Site Details

Cottam

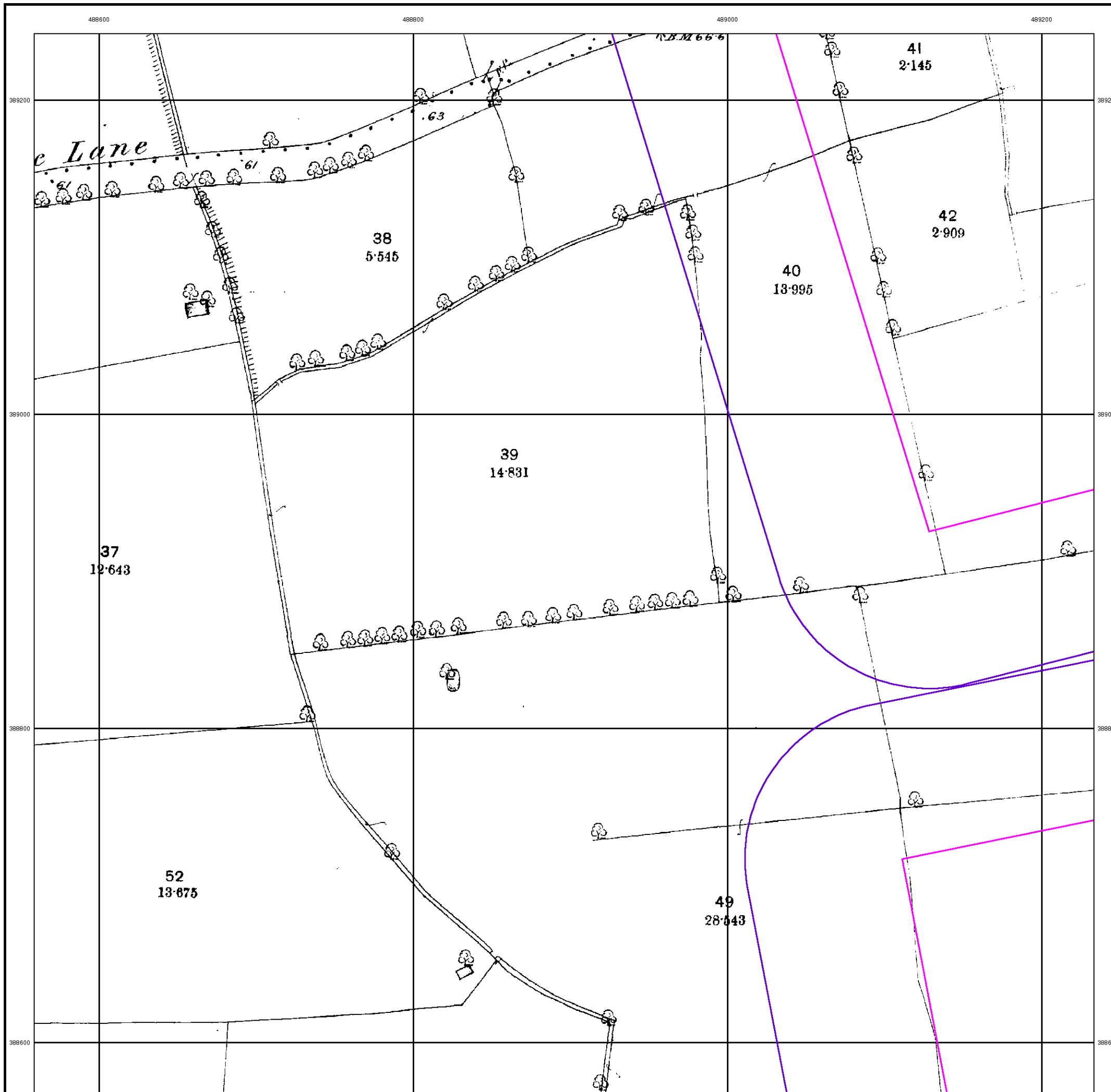

Lincolnshire
Published 1906

Source map scale - 1:2,500

The historical maps shown were reproduced from maps predominantly held at the scale adopted for England, Wales and Scotland in the 1840's. In 1854 the 1:2,500 scale was adopted for mapping urban areas and by 1896 it covered the whole of what were considered to be the cultivated parts of Great Britain. The published date given below is often some years later than the surveyed date. Before 1938, all OS maps were based on the Cassini Projection, with independent surveys of a single county or group of counties, giving rise to significant inaccuracies in outlying areas.

Map Name(s) and Date(s)

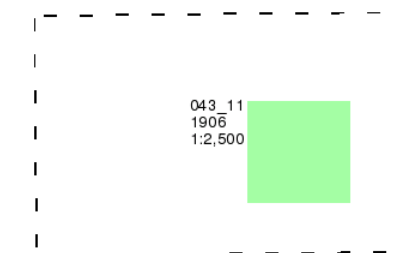

Historical Map - Segment E13

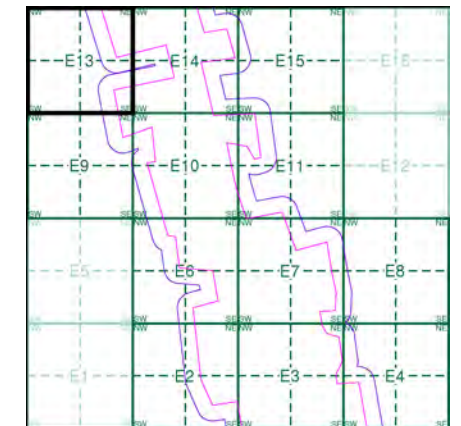

Order Details

Order Number: 297990273_1_1
 Customer Ref: 21-1088.04
 National Grid Reference: 489860, 387850
 Slice: E
 Site Area (Ha): 469.98
 Search Buffer (m): 100

Site Details

Cottam

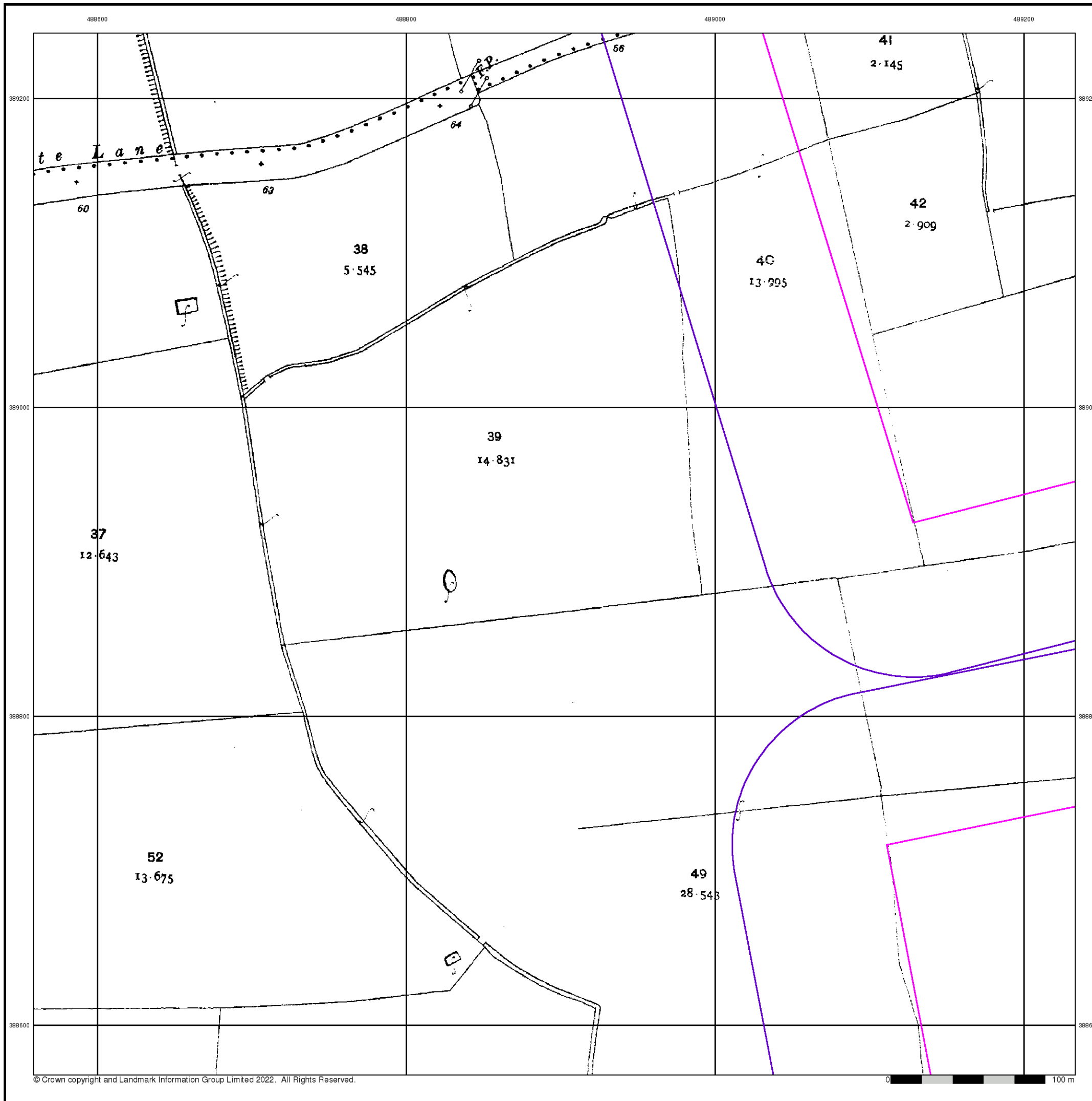

Ordnance Survey Plan

Published 1972

Source map scale - 1:2,500

The historical maps shown were reproduced from maps predominantly held at the scale adopted for England, Wales and Scotland in the 1840's. In 1854 the 1:2,500 scale was adopted for mapping urban areas and by 1896 it covered the whole of what were considered to be the cultivated parts of Great Britain. The published date given below is often some years later than the surveyed date. Before 1938, all OS maps were based on the Cassini Projection, with independent surveys of a single county or group of counties, giving rise to significant inaccuracies in outlying areas.

Map Name(s) and Date(s)

SK8889 1972 1:2,500	SK8989 1972 1:2,500
SK8888 1972 1:2,500	SK8988 1972 1:2,500

Historical Map - Segment E13

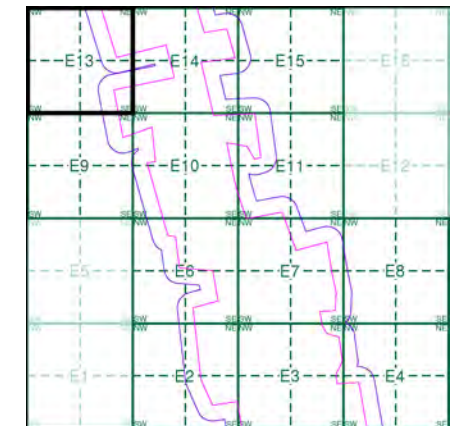

Order Details

Order Number: 297990273_1_1
 Customer Ref: 21-1088.04
 National Grid Reference: 489860, 387850
 Slice: E
 Site Area (Ha): 469.98
 Search Buffer (m): 100

Site Details

Cottam

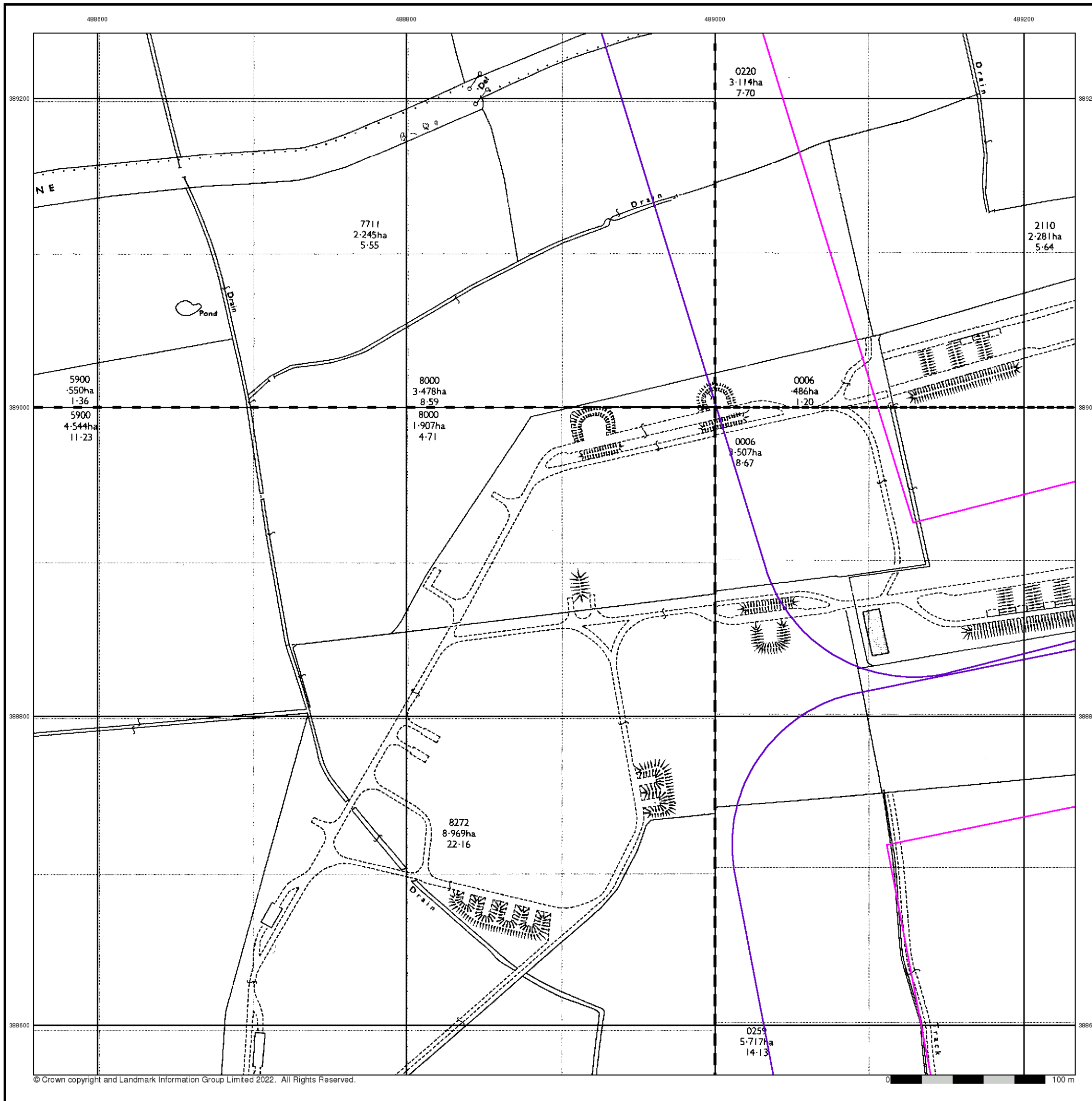

Historical Mapping Legends

Ordnance Survey County Series and Ordnance Survey Plan 1:2,500

Quarry **Gravel Pit** **Sand Pit**
Clay Pit **Shingle** **Refuse Heap**
Sloping Masonry **Flat Rock**
Marsh **Reeds** **Osiers**
Rough Pasture **Furze** **Wood**
Mixed Wood **Brushwood** **Orchard**
Fir **Ford** **Stepping Stones**
Ferry **Waterfall** **Lock**
Trig. Station **Altitude at Trig. Station**
B.M. 325.9 **Bench Mark** **Surface Level**
Arrow denotes flow of water **Antiquities (site of)**
Cutting **Embankment**
Railway crossing Road **Level Crossing** **Road crossing Railway**
Railway crossing River or Canal **Road over single stream** **Road over River or Canal**
County Boundary (Geographical)
County & Civil Parish Boundary
Administrative County & Civil Parish Boundary
County Borough Boundary (England)
County Burgh Boundary (Scotland)
Co. Boro. Bdy.
Co. Burgh Bdy.
BP BS Boundary Post or Stone **P.C.B** Police Call Box
B.R. Bridle Road **P** Pump
E.P Electricity Pylon **S.P** Signal Post
F.B. Foot Bridge **SL** Sluice
F.P. Foot Path **Sp.** Spring
G.P Guide Post or Board **T.C.B** Telephone Call Box
M.S Mile Stone **Tr.** Trough
M.P M.R Mooring Post or Ring **W** Well

Ordnance Survey Plan, Additional SIMs and Supply of Unpublished Survey Information 1:2,500 and 1:1,250

Inactive Quarry, Chalk Pit or Clay Pit **Active Quarry, Chalk Pit or Clay Pit**
Rock **Boulders**
Cliff **Slopes** **Top**
Roofed Building **Glazed Roof Building**
Sloping Masonry **Archway**
Non-Coniferous Tree (surveyed) **Coniferous Tree (surveyed)**
Non-Coniferous Trees (not surveyed) **Coniferous Trees (not surveyed)**
Orchard Tree **Scrub** **Bracken**
Coppice, Osier **Reeds** **Marsh, Saltings**
Rough Grassland **Heath** **Culvert**
Direction of water flow **Bench Mark** **Antiquity (site of)**
Cave Entrance **Triangulation Station** **Electricity Pylon**
Electricity Transmission Line
County Boundary (Geographical)
County & Civil Parish Boundary
Civil Parish Boundary
Admin. County or County Bor. Boundary
London Borough Boundary
Symbol marking point where boundary mereing changes
BH Beer House **P** Pillar, Pole or Post
BP, BS Boundary Post or Stone **PO** Post Office
Cn, C Capstan, Crane **PC** Public Convenience
Chy Chimney **PH** Public House
D Fn Drinking Fountain **Pp** Pump
EI P Electricity Pillar or Post **SB, S Br** Signal Box or Bridge
FAP Fire Alarm Pillar **SP, SL** Signal Post or Light
FB Foot Bridge **Spr** Spring
GP Guide Post **Tk** Tank or Track
H Hydrant or Hydraulic **TCB** Telephone Call Box
LC Level Crossing **TCP** Telephone Call Post
MH Manhole **Tr** Trough
MP Mile Post or Mooring Post **Wr Pt, Wr T** Water Point, Water Tap
MS Mile Stone **W** Well
NTL Normal Tidal Limit **Wd Pp** Wind Pump

Large-Scale National Grid Data 1:2,500 and 1:1,250

Cliff **Slopes** **Top**
Rock **Rock (scattered)**
Boulders **Boulders (scattered)**
Positioned Boulder **Scree**
Non-Coniferous Tree (surveyed) **Coniferous Tree (surveyed)**
Non-Coniferous Trees (not surveyed) **Coniferous Trees (not surveyed)**
Orchard Tree **Scrub** **Bracken**
Coppice, Osier **Reeds** **Marsh, Saltings**
Rough Grassland **Heath** **Culvert**
Direction of water flow **Triangulation Station** **Antiquity (site of)**
Electricity Transmission Line **Electricity Pylon**
B.M. 231.60m Bench Mark **Buildings with Building Seed**
Roofed Building **Glazed Roof Building**
Civil parish/community boundary
District boundary
County boundary
Boundary post/stone
Boundary mereing symbol (note: these always appear in opposed pairs or groups of three)
Bks Barracks **P** Pillar, Pole or Post
Bty Battery **PO** Post Office
Cemy Cemetery **PC** Public Convenience
Chy Chimney **Pp** Pump
Cis Cistern **Ppg Sta** Pumping Station
Dismtd Rly Dismantled Railway **PW** Place of Worship
EI Gen Sta Electricity Generating Station **Sewage Ppg Sta** Sewage Pumping Station
EI P Electricity Pole, Pillar **SB, S Br** Signal Box or Bridge
EI Sub Sta Electricity Sub Station **SP, SL** Signal Post or Light
FB Filter Bed **Spr** Spring
Fn / D Fn Fountain / Drinking Ftn. **Tk** Tank or Track
Gas Gov Gas Valve Compound **Tr** Trough
GVC Gas Governor **Wd Pp** Wind Pump
GP Guide Post **Wr Pt, Wr T** Water Point, Water Tap
MH Manhole **Wks** Works (building or area)
MP, MS Mile Post or Mile Stone **W** Well



Historical Mapping & Photography included:

Mapping Type	Scale	Date	Pg
Lincolnshire	1:2,500	1886	2
Lincolnshire	1:2,500	1906	3
Ordnance Survey Plan	1:2,500	1972	4
Large-Scale National Grid Data	1:2,500	1994	5

Historical Map - Segment E14

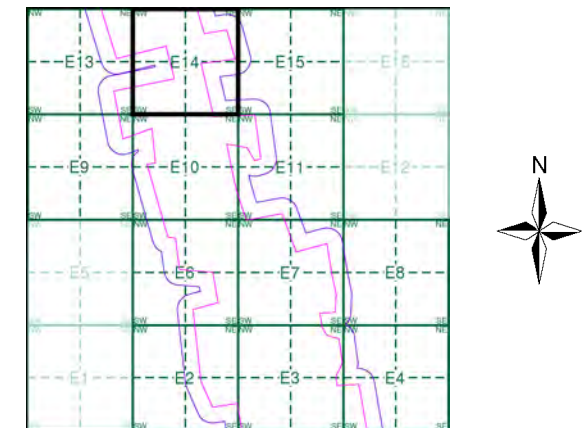

Order Details

Order Number: 297990273_1_1
 Customer Ref: 21-1088.04
 National Grid Reference: 489860, 387850
 Slice: E
 Site Area (Ha): 469.98
 Search Buffer (m): 100

Site Details

Cottam



Tel:
Fax:
Web:

Lincolnshire
Published 1886

Source map scale - 1:2,500

The historical maps shown were reproduced from maps predominantly held at the scale adopted for England, Wales and Scotland in the 1840's. In 1854 the 1:2,500 scale was adopted for mapping urban areas and by 1896 it covered the whole of what were considered to be the cultivated parts of Great Britain. The published date given below is often some years later than the surveyed date. Before 1938, all OS maps were based on the Cassini Projection, with independent surveys of a single county or group of counties, giving rise to significant inaccuracies in outlying areas.

Map Name(s) and Date(s)

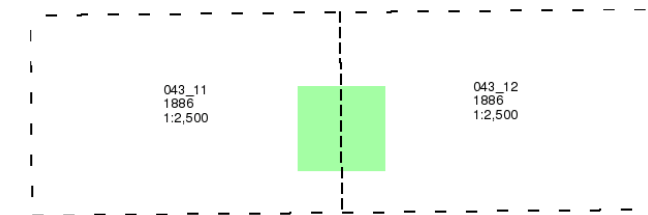

Historical Map - Segment E14

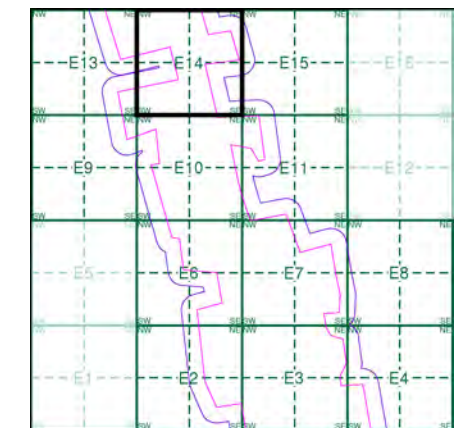

Order Details

Order Number: 297990273_1_1
 Customer Ref: 21-1088.04
 National Grid Reference: 489860, 387850
 Slice: E
 Site Area (Ha): 469.98
 Search Buffer (m): 100

Site Details

Cottam

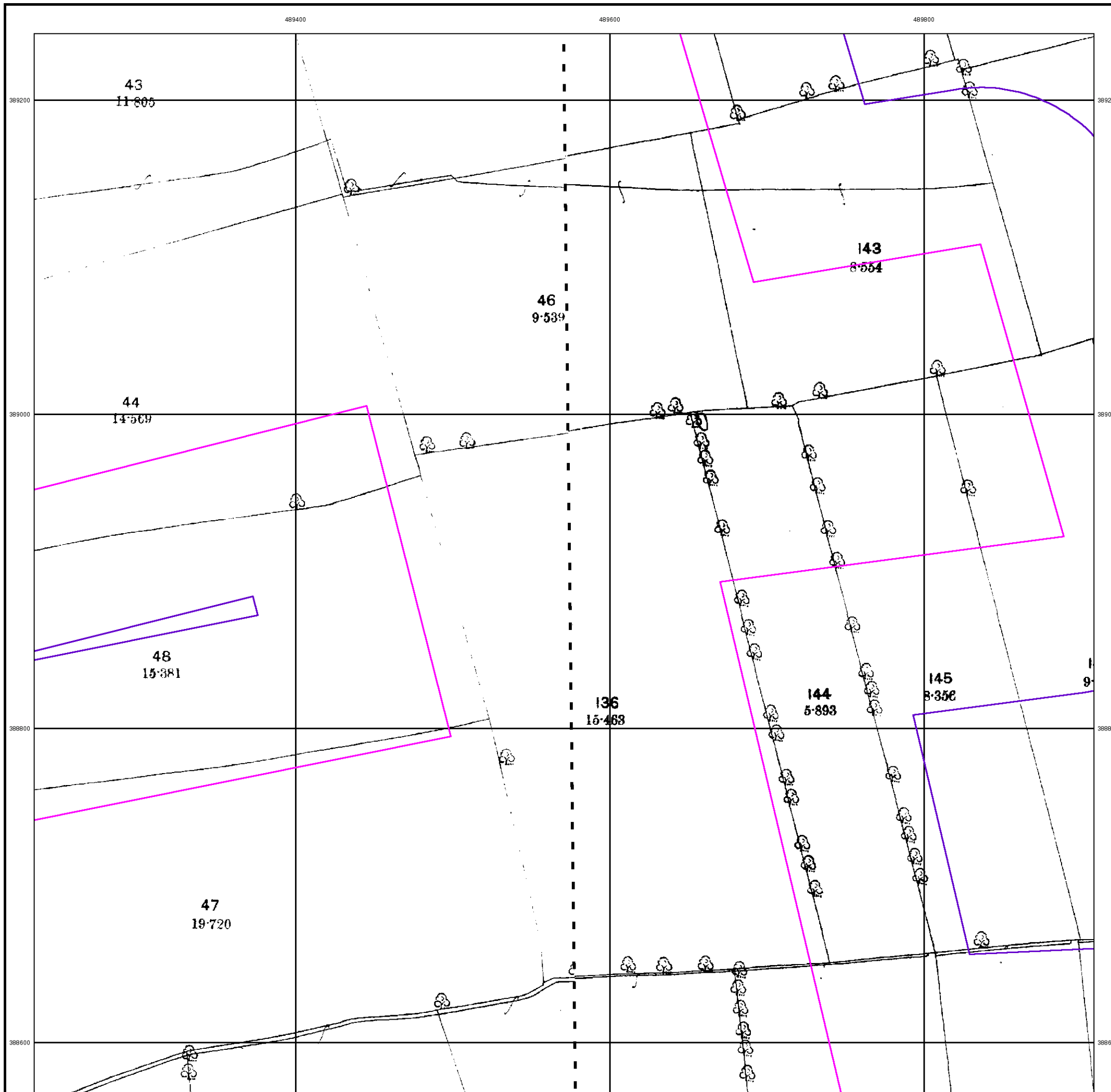

Lincolnshire

Published 1906

Source map scale - 1:2,500

The historical maps shown were reproduced from maps predominantly held at the scale adopted for England, Wales and Scotland in the 1840's. In 1854 the 1:2,500 scale was adopted for mapping urban areas and by 1896 it covered the whole of what were considered to be the cultivated parts of Great Britain. The published date given below is often some years later than the surveyed date. Before 1938, all OS maps were based on the Cassini Projection, with independent surveys of a single county or group of counties, giving rise to significant inaccuracies in outlying areas.

Map Name(s) and Date(s)

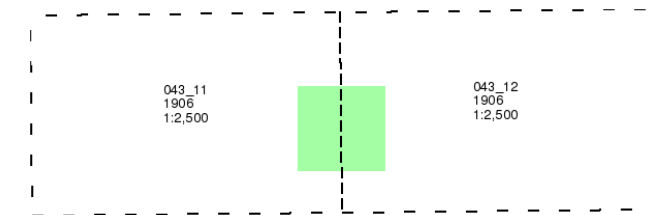

Historical Map - Segment E14

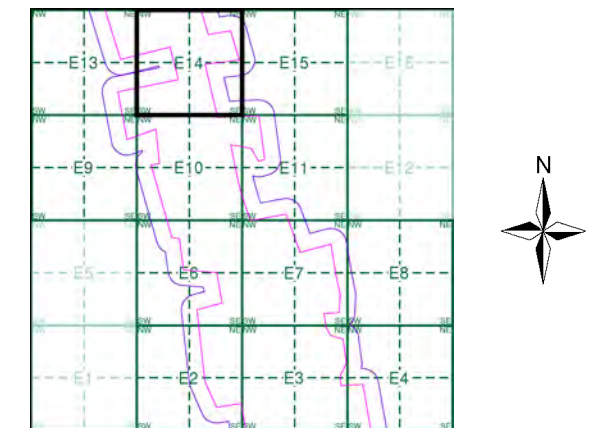

Order Details

Order Number: 297990273_1_1
 Customer Ref: 21-1088.04
 National Grid Reference: 489860, 387850
 Slice: E
 Site Area (Ha): 469.98
 Search Buffer (m): 100

Site Details

Cottam

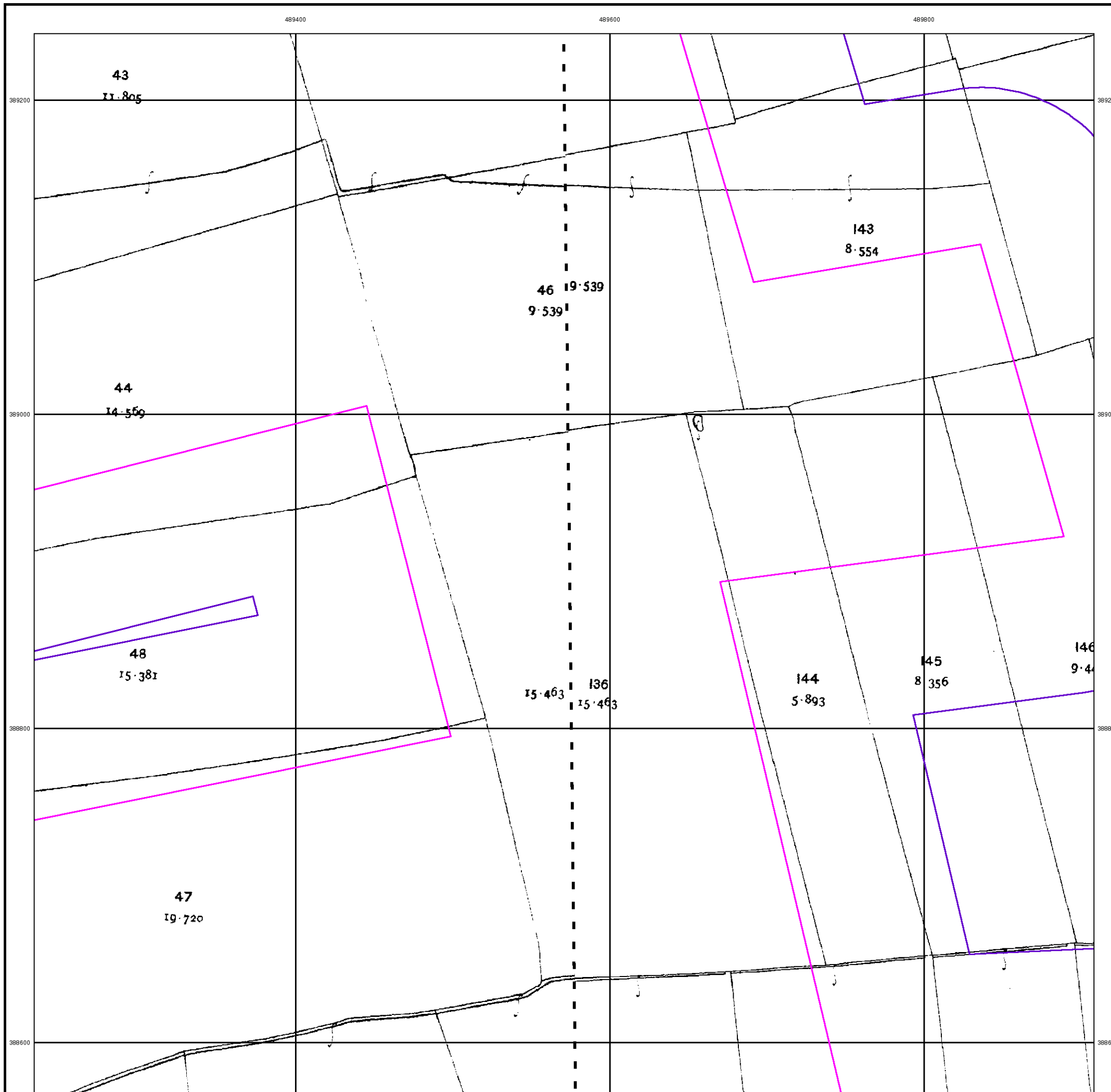

Ordnance Survey Plan

Published 1972

Source map scale - 1:2,500

The historical maps shown were reproduced from maps predominantly held at the scale adopted for England, Wales and Scotland in the 1840's. In 1854 the 1:2,500 scale was adopted for mapping urban areas and by 1896 it covered the whole of what were considered to be the cultivated parts of Great Britain. The published date given below is often some years later than the surveyed date. Before 1938, all OS maps were based on the Cassini Projection, with independent surveys of a single county or group of counties, giving rise to significant inaccuracies in outlying areas.

Map Name(s) and Date(s)

SK8989	1972	1:2,500
SK8988	1972	1:2,500

Historical Map - Segment E14

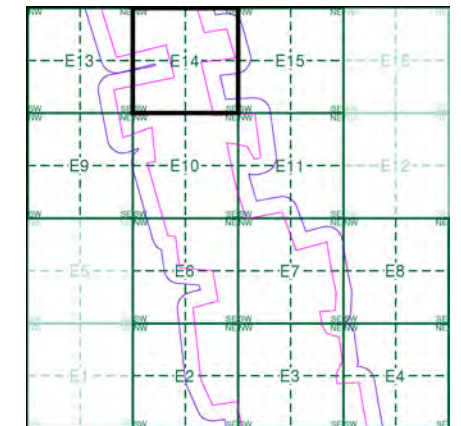

Order Details

Order Number: 297990273_1_1
 Customer Ref: 21-1088.04
 National Grid Reference: 489860, 387850
 Slice: E
 Site Area (Ha): 469.98
 Search Buffer (m): 100

Site Details

Cottam

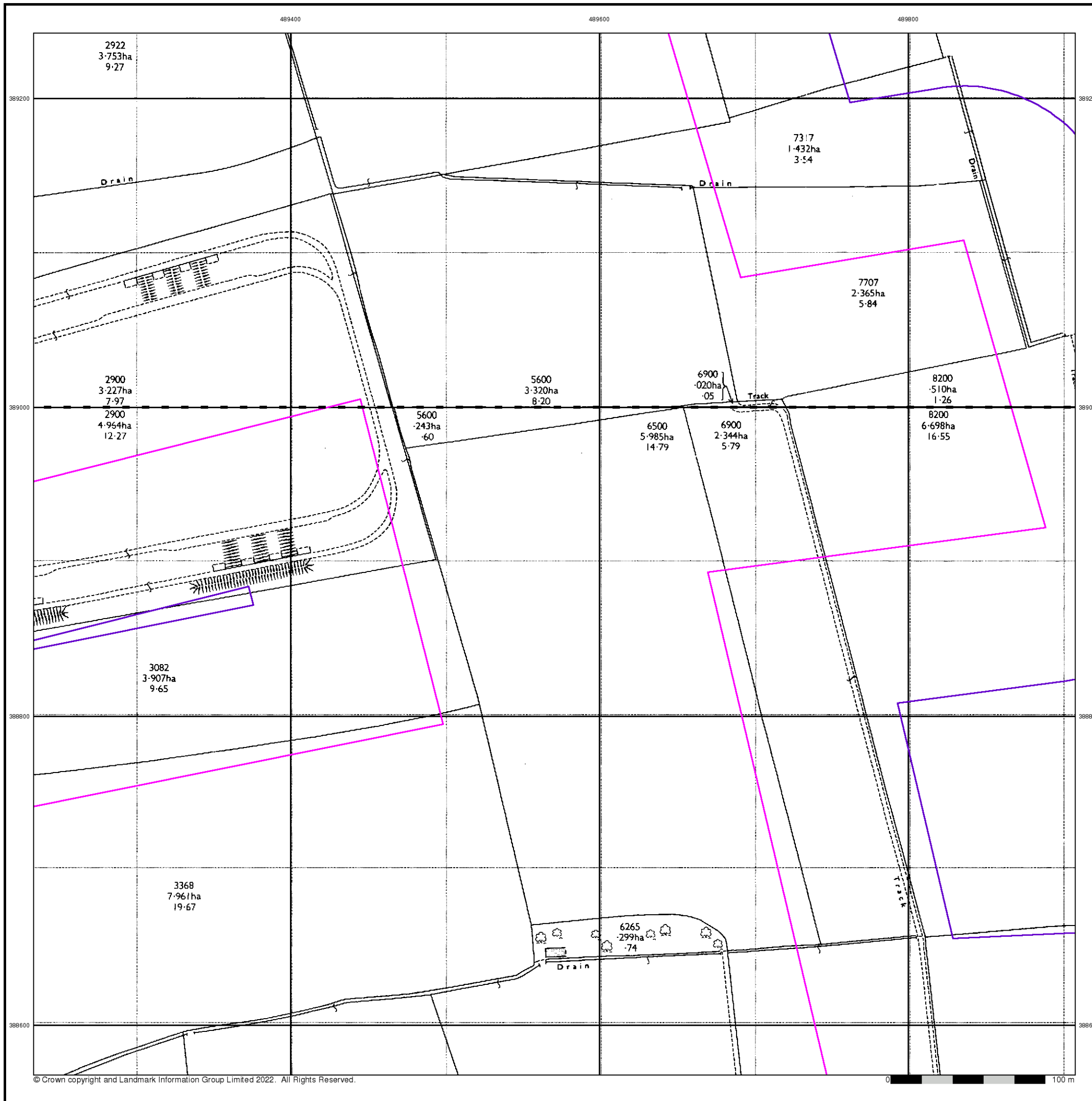

Large-Scale National Grid Data

Published 1994

Source map scale - 1:2,500

'Large Scale National Grid Data' superseded SIM cards (Ordnance Survey's 'Survey of Information on Microfilm') in 1992, and continued to be produced until 1999. These maps were the fore-runners of digital mapping and so provide detailed information on houses and roads, but tend to show less topographic features such as vegetation. These maps were produced at both 1:2,500 and 1:1,250 scales.

Map Name(s) and Date(s)

SK8989	1994	1:2,500
SK8988	1994	1:2,500

Historical Map - Segment E14

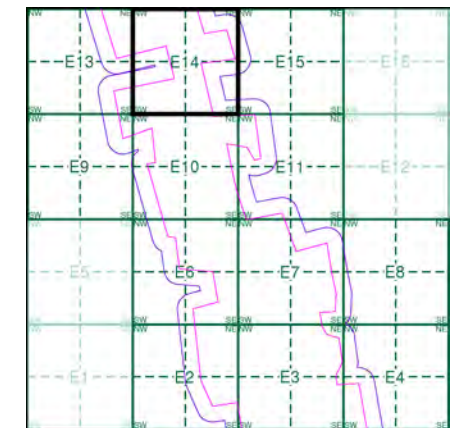

Order Details

Order Number: 297990273_1_1
 Customer Ref: 21-1088.04
 National Grid Reference: 489860, 387850
 Slice: E
 Site Area (Ha): 469.98
 Search Buffer (m): 100

Site Details

Cottam

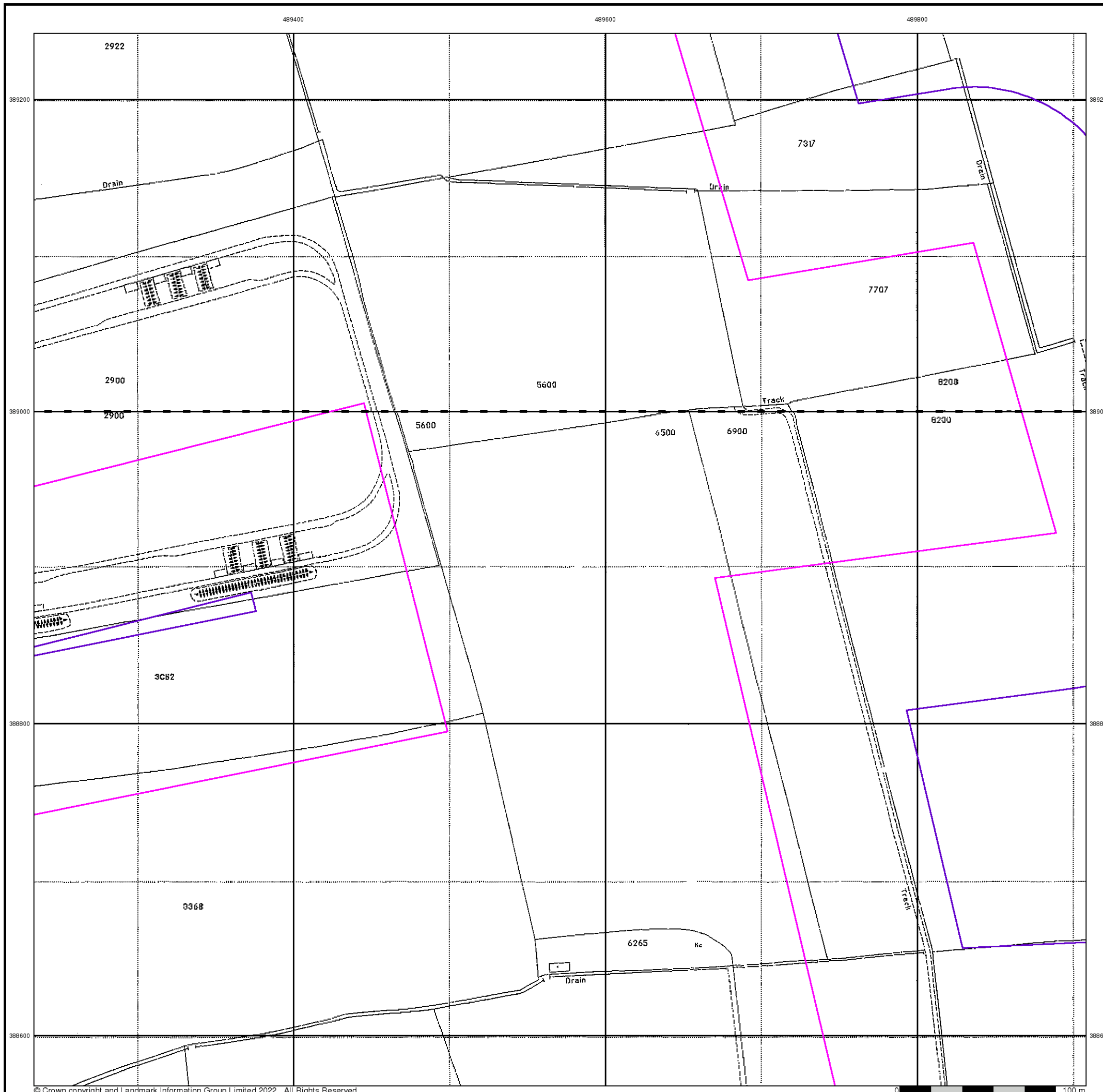

Historical Mapping Legends

Ordnance Survey County Series and Ordnance Survey Plan 1:2,500

Quarry **Gravel Pit** **Sand Pit**
Clay Pit **Shingle** **Refuse Heap**
Sloping Masonry **Flat Rock**
Marsh **Reeds** **Osiers**
Rough Pasture **Furze** **Wood**
Mixed Wood **Brushwood** **Orchard**
Fir **Ford** **Stepping Stones**
Ferry **Waterfall** **Lock**
Trig. Station **Altitude at Trig. Station**
B.M. 325.9 **Bench Mark** **Surface Level**
Arrow denotes flow of water **Antiquities (site of)**
Cutting **Embankment**
Railway crossing Road **Level Crossing** **Road crossing Railway**
Railway crossing River or Canal **Road over single stream** **Road over River or Canal**
County Boundary (Geographical)
County & Civil Parish Boundary
Administrative County & Civil Parish Boundary
County Borough Boundary (England)
County Burgh Boundary (Scotland)
Co. Boro. Bdy.
Co. Burgh Bdy.
Boundary Post or Stone **Police Call Box**
B.R. Bridle Road **P. Pump**
E.P. Electricity Pylon **S.P. Signal Post**
F.B. Foot Bridge **Sl. Sluice**
F.P. Foot Path **Sp. Spring**
G.P. Guide Post or Board **T.C.B. Telephone Call Box**
M.S. Mile Stone **Tr. Trough**
M.P. M.R. Mooring Post or Ring **W. Well**

Ordnance Survey Plan, Additional SIMs and Supply of Unpublished Survey Information 1:2,500 and 1:1,250

Inactive Quarry, Chalk Pit or Clay Pit **Active Quarry, Chalk Pit or Clay Pit**
Rock **Boulders**
Cliff **Slopes** **Top**
Roofed Building **Glazed Roof Building**
Sloping Masonry **Archway**
Non-Coniferous Tree (surveyed) **Coniferous Tree (surveyed)**
Non-Coniferous Trees (not surveyed) **Coniferous Trees (not surveyed)**
Orchard Tree **Scrub** **Bracken**
Coppice, Osier **Reeds** **Marsh, Saltings**
Rough Grassland **Heath** **Culvert**
Direction of water flow **Bench Mark** **Antiquity (site of)**
Cave Entrance **Triangulation Station** **Electricity Pylon**
Electricity Transmission Line
County Boundary (Geographical)
County & Civil Parish Boundary
Civil Parish Boundary
Admin. County or County Bor. Boundary
London Borough Boundary
Symbol marking point where boundary mereing changes
BH Beer House **P Pillar, Pole or Post**
BP, BS Boundary Post or Stone **PO Post Office**
Cn, C Capstan, Crane **PC Public Convenience**
Chy Chimney **PH Public House**
D Fn Drinking Fountain **Pp Pump**
EI P Electricity Pillar or Post **SB, S Br Signal Box or Bridge**
FAP Fire Alarm Pillar **SP, SL Signal Post or Light**
FB Foot Bridge **Spr Spring**
GP Guide Post **Tk Tank or Track**
H Hydrant or Hydraulic **TCB Telephone Call Box**
LC Level Crossing **TCP Telephone Call Post**
MH Manhole **Tr Trough**
MP Mile Post or Mooring Post **Wr Pt, Wr T Water Point, Water Tap**
MS Mile Stone **W Well**
NTL Normal Tidal Limit **Wd Pp Wind Pump**

Large-Scale National Grid Data 1:2,500 and 1:1,250

Cliff **Slopes** **Top**
Rock **Rock (scattered)**
Boulders **Boulders (scattered)**
Positioned Boulder **Scree**
Non-Coniferous Tree (surveyed) **Coniferous Tree (surveyed)**
Non-Coniferous Trees (not surveyed) **Coniferous Trees (not surveyed)**
Orchard Tree **Scrub** **Bracken**
Coppice, Osier **Reeds** **Marsh, Saltings**
Rough Grassland **Heath** **Culvert**
Direction of water flow **Triangulation Station** **Antiquity (site of)**
Electricity Transmission Line **Electricity Pylon**
Bench Mark **Buildings with Building Seed**
Roofed Building **Glazed Roof Building**
Civil parish/community boundary
District boundary
County boundary
Boundary post/stone
Boundary mereing symbol (note: these always appear in opposed pairs or groups of three)
Bks Barracks **P Pillar, Pole or Post**
Bty Battery **PO Post Office**
Cemy Cemetery **PC Public Convenience**
Chy Chimney **Pp Pump**
Cis Cistern **Ppg Sta Pumping Station**
Dismtd Rly Dismantled Railway **PW Place of Worship**
EI Gen Sta Electricity Generating Station **Sewage Ppg Sta Sewage Pumping Station**
EI P Electricity Pole, Pillar **SB, S Br Signal Box or Bridge**
EI Sub Sta Electricity Sub Station **SP, SL Signal Post or Light**
FB Filter Bed **Spr Spring**
Fn / D Fn Fountain / Drinking Ftn. **Tk Tank or Track**
Gas Gov Gas Valve Compound **Tr Trough**
GVC Gas Governor **Wd Pp Wind Pump**
GP Guide Post **Wr Pt, Wr T Water Point, Water Tap**
MH Manhole **Wks Works (building or area)**
MP, MS Mile Post or Mile Stone **W Well**



Historical Mapping & Photography included:

Mapping Type	Scale	Date	Pg
Lincolnshire	1:2,500	1886	2
Lincolnshire	1:2,500	1906	3
Ordnance Survey Plan	1:2,500	1972 - 1974	4
Large-Scale National Grid Data	1:2,500	1994	5

Historical Map - Segment E15

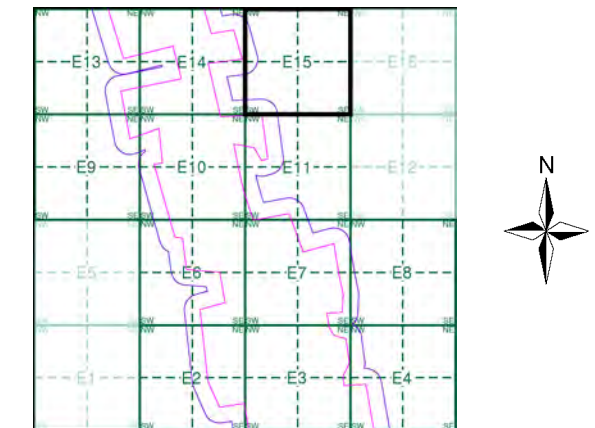

Order Details

Order Number: 297990273_1_1
 Customer Ref: 21-1088.04
 National Grid Reference: 489860, 387850
 Slice: E
 Site Area (Ha): 469.98
 Search Buffer (m): 100

Site Details

Cottam



Tel: [Redacted]
 Fax: [Redacted]
 Web: [Redacted]

Lincolnshire

Published 1886

Source map scale - 1:2,500

The historical maps shown were reproduced from maps predominantly held at the scale adopted for England, Wales and Scotland in the 1840's. In 1854 the 1:2,500 scale was adopted for mapping urban areas and by 1896 it covered the whole of what were considered to be the cultivated parts of Great Britain. The published date given below is often some years later than the surveyed date. Before 1938, all OS maps were based on the Cassini Projection, with independent surveys of a single county or group of counties, giving rise to significant inaccuracies in outlying areas.

Map Name(s) and Date(s)

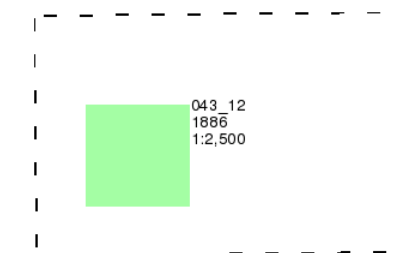

Historical Map - Segment E15

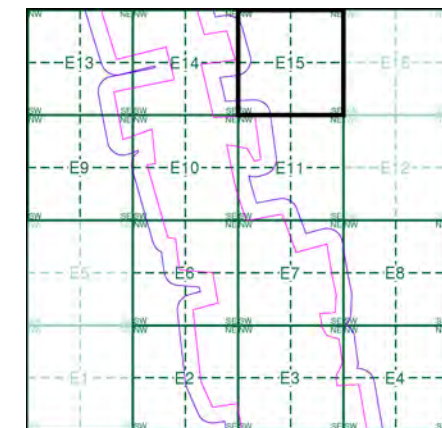

Order Details

Order Number: 297990273_1_1
 Customer Ref: 21-1088.04
 National Grid Reference: 489860, 387850
 Slice: E
 Site Area (Ha): 469.98
 Search Buffer (m): 100

Site Details

Cottam

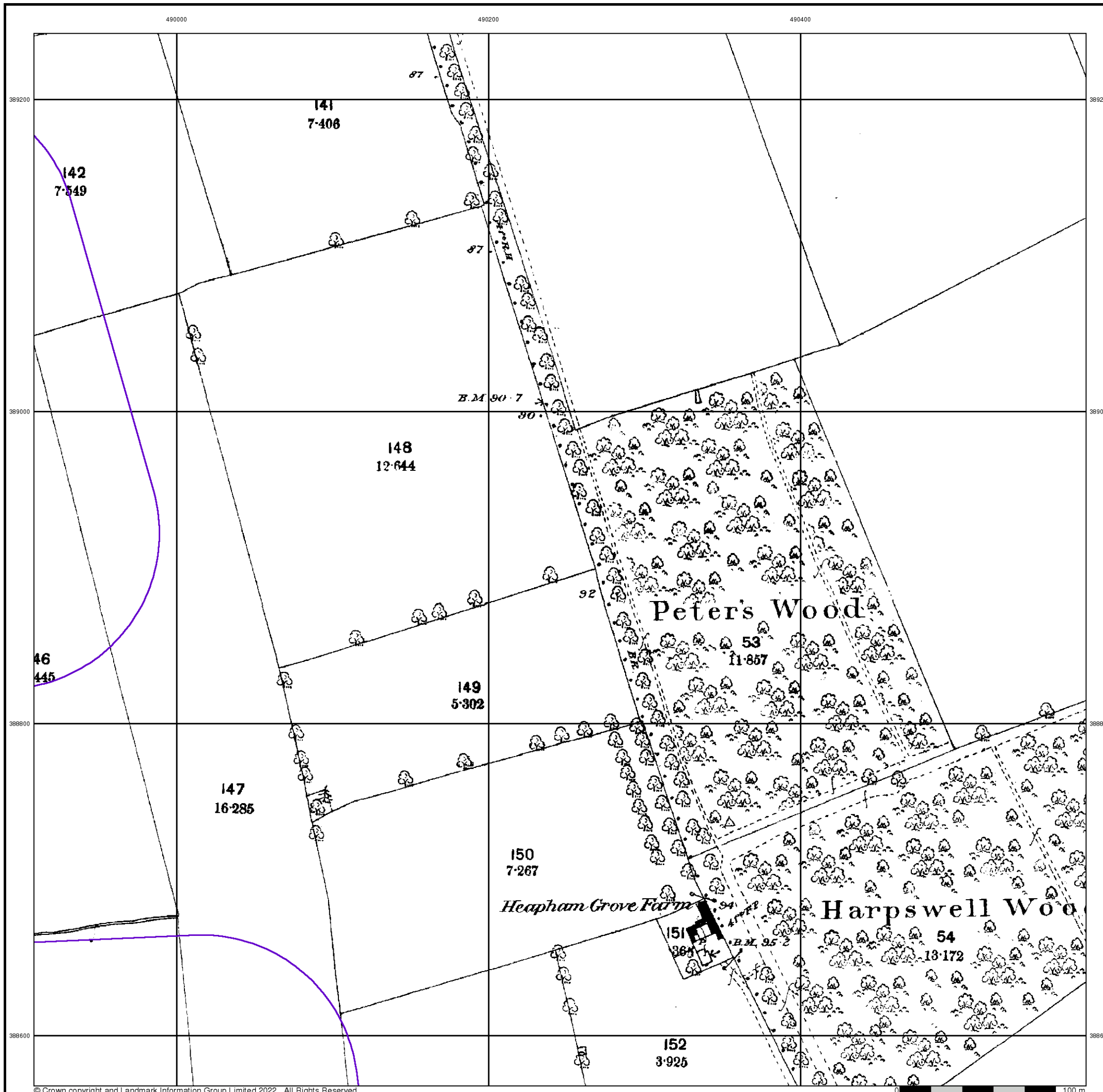

Lincolnshire

Published 1906

Source map scale - 1:2,500

The historical maps shown were reproduced from maps predominantly held at the scale adopted for England, Wales and Scotland in the 1840's. In 1854 the 1:2,500 scale was adopted for mapping urban areas and by 1896 it covered the whole of what were considered to be the cultivated parts of Great Britain. The published date given below is often some years later than the surveyed date. Before 1938, all OS maps were based on the Cassini Projection, with independent surveys of a single county or group of counties, giving rise to significant inaccuracies in outlying areas.

Map Name(s) and Date(s)

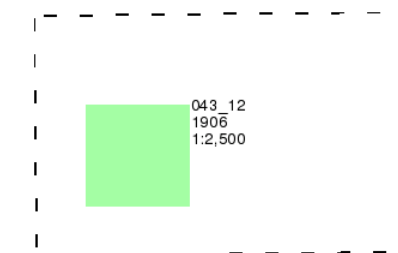

Historical Map - Segment E15

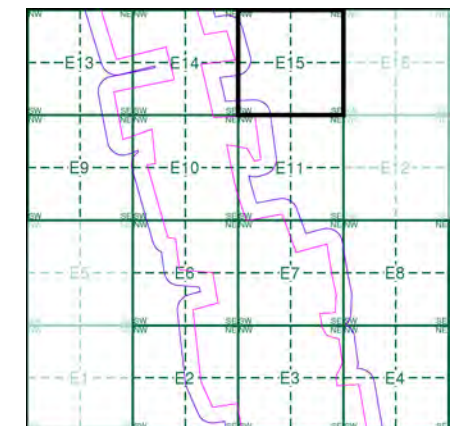

Order Details

Order Number: 297990273_1_1
 Customer Ref: 21-1088.04
 National Grid Reference: 489860, 387850
 Slice: E
 Site Area (Ha): 469.98
 Search Buffer (m): 100

Site Details

Cottam

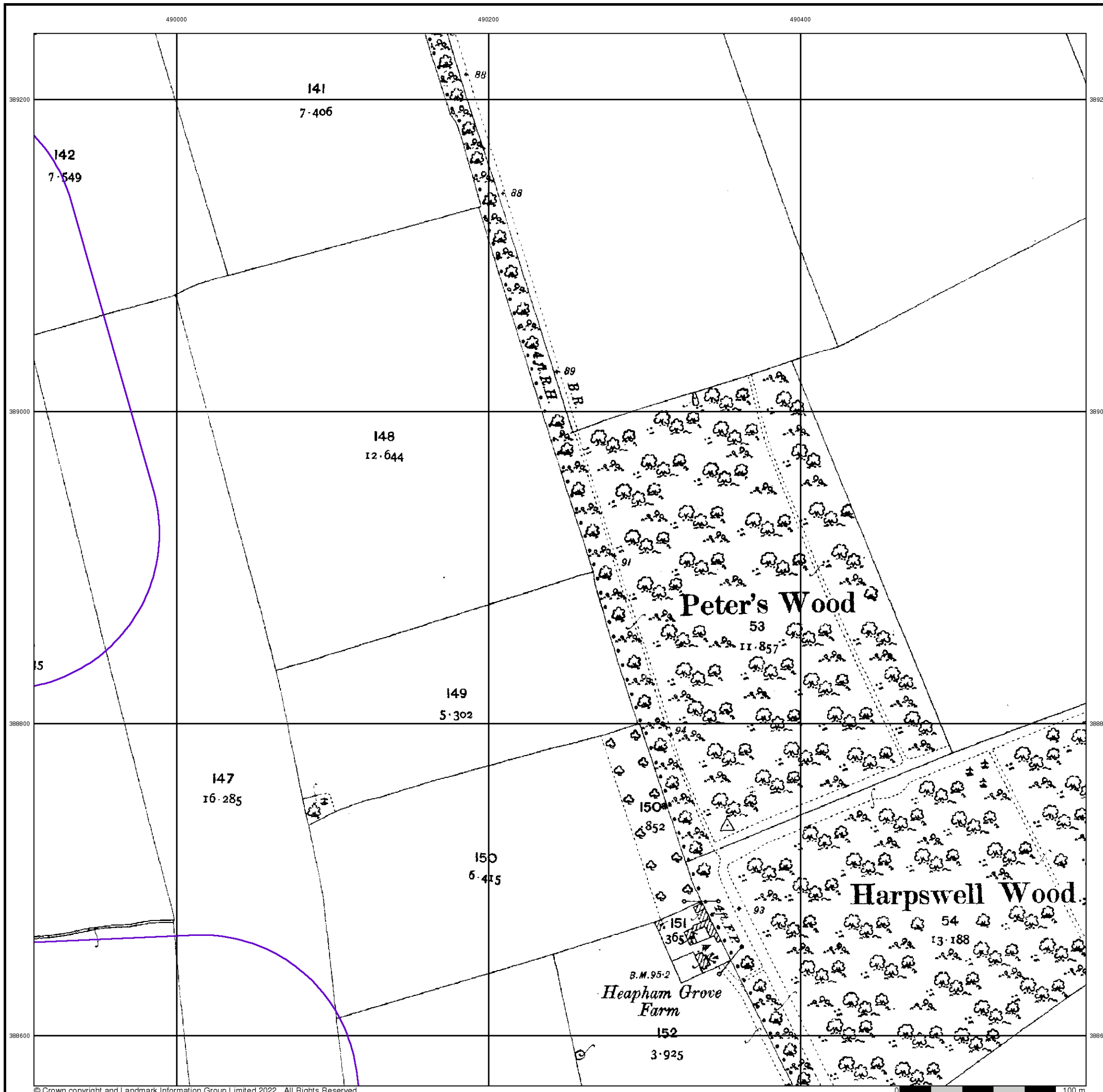

Ordnance Survey Plan
Published 1972 - 1974
Source map scale - 1:2,500

The historical maps shown were reproduced from maps predominantly held at the scale adopted for England, Wales and Scotland in the 1840's. In 1854 the 1:2,500 scale was adopted for mapping urban areas and by 1896 it covered the whole of what were considered to be the cultivated parts of Great Britain. The published date given below is often some years later than the surveyed date. Before 1938, all OS maps were based on the Cassini Projection, with independent surveys of a single county or group of counties, giving rise to significant inaccuracies in outlying areas.

Map Name(s) and Date(s)

SK8989 1972 1:2,500	SK9089 1974 1:2,500
SK8988 1972 1:2,500	SK9088 1974 1:2,500

Historical Map - Segment E15

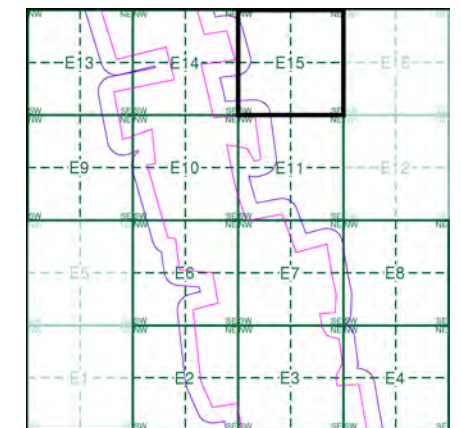

Order Details

Order Number: 297990273_1_1
 Customer Ref: 21-1088.04
 National Grid Reference: 489860, 387850
 Slice: E
 Site Area (Ha): 469.98
 Search Buffer (m): 100

Site Details

Cottam

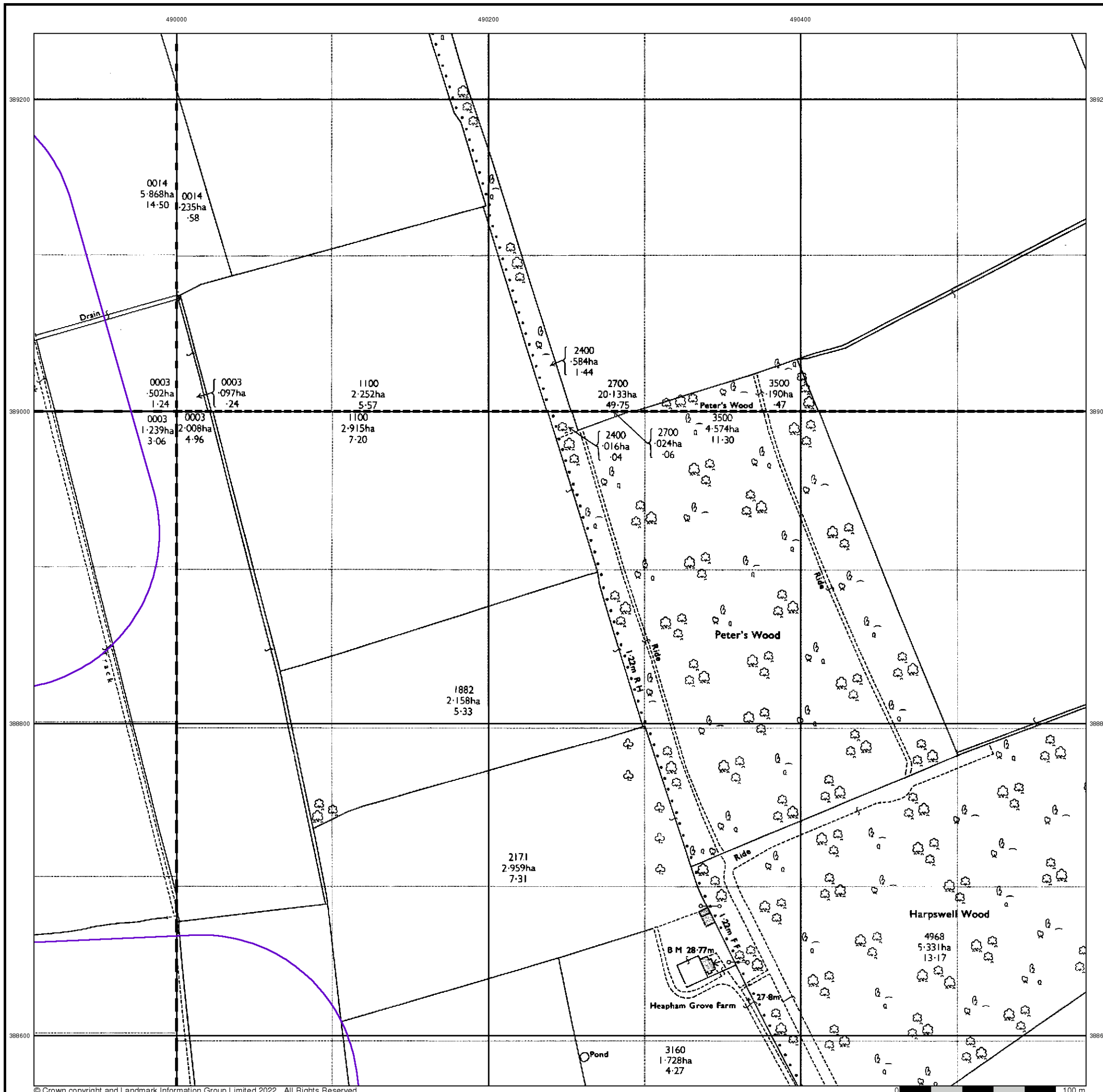

Large-Scale National Grid Data

Published 1994

Source map scale - 1:2,500

'Large Scale National Grid Data' superseded SIM cards (Ordnance Survey's 'Survey of Information on Microfilm') in 1992, and continued to be produced until 1999. These maps were the fore-runners of digital mapping and so provide detailed information on houses and roads, but tend to show less topographic features such as vegetation. These maps were produced at both 1:2,500 and 1:1,250 scales.

Map Name(s) and Date(s)

SK8989	SK9089
1994	1994
12,500	12,500
SK8988	SK9088
1994	1994
12,500	12,500

Historical Map - Segment E15

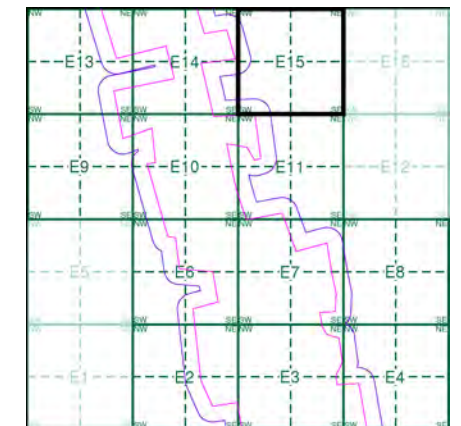

Order Details

Order Number: 297990273_1_1
 Customer Ref: 21-1088.04
 National Grid Reference: 489860, 387850
 Slice: E
 Site Area (Ha): 469.98
 Search Buffer (m): 100

Site Details

Cottam

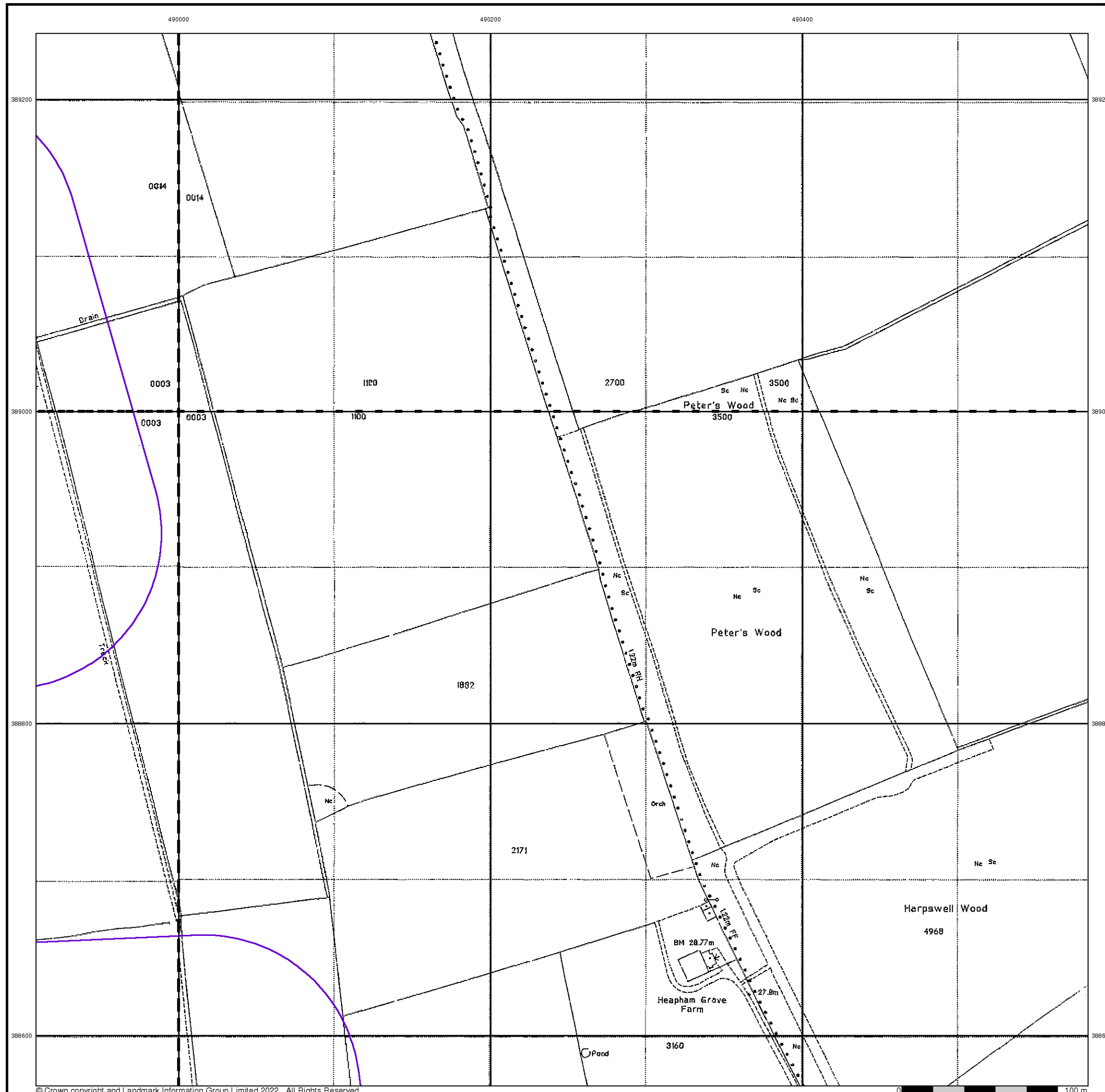

Historical Mapping Legends

Ordnance Survey County Series 1:10,560

	Gravel Pit		Sand Pit		Other Pits
	Quarry		Shingle		Orchard
	Osiers		Reeds		Marsh
	Mixed Wood		Deciduous		Brushwood
	Fir		Furze		Rough Pasture
	Arrow denotes flow of water		Trigonometrical Station		
	Site of Antiquities		Bench Mark		
	Pump, Guide Post, Signal Post		Well, Spring, Boundary Post		
	-285 Surface Level				
	Sketched Contour		Instrumental Contour		
	Main Roads		Minor Roads		
	Sunken Road		Raised Road		
	Road over Railway		Railway over River		
	Railway over Road		Level Crossing		
	Road over River or Canal		Road over Stream		
	Road over Stream				
	County Boundary (Geographical)				
	County & Civil Parish Boundary				
	Administrative County & Civil Parish Boundary				
	County Borough Boundary (England)				
	County Burgh Boundary (Scotland)				
	Rural District Boundary				
	Civil Parish Boundary				

Ordnance Survey Plan 1:10,000

	Chalk Pit, Clay Pit or Quarry		Gravel Pit
	Sand Pit		Disused Pit or Quarry
	Refuse or Slag Heap		Lake, Loch or Pond
	Dunes		Boulders
	Coniferous Trees		Non-Coniferous Trees
	Orchard		Scrub
	Coppice		Heath
	Rough Grassland		Marsh
	Reeds		Saltings
	Building		Glasshouse
	Sloping Masonry		Pylon
	Electricity Transmission Line		Pole
	Cutting		Embankment
	Standard Gauge Multiple Track		Standard Gauge Single Track
	Siding, Tramway or Mineral Line		Narrow Gauge
	Geographical County		
	Administrative County, County Borough or County of City		
	Municipal Borough, Urban or Rural District, Burgh or District Council		
	Borough, Burgh or County Constituency Shown only when not coincident with other boundaries		
	Civil Parish Shown alternately when coincidence of boundaries occurs		
	BP, BS Boundary Post or Stone		Pol Sta Police Station
	Ch Church		PO Post Office
	CH Club House		PC Public Convenience
	F E Sta Fire Engine Station		PH Public House
	FB Foot Bridge		SB Signal Box
	Fn Fountain		Spr Spring
	GP Guide Post		TCB Telephone Call Box
	MP Mile Post		TCP Telephone Call Post
	MS Mile Stone		W Well

1:10,000 Raster Mapping

	Gravel Pit		Refuse tip or slag heap
	Rock		Rock (scattered)
	Boulders		Boulders (scattered)
	Shingle		Mud
	Sand		Sand Pit
	Slopes		Top of cliff
	General detail		Underground detail
	Overhead detail		Narrow gauge railway
	Multi-track railway		Single track railway
	County boundary (England only)		Civil, parish or community boundary
	District, Unitary, Metropolitan, London Borough boundary		Constituency boundary
	Area of wooded vegetation		Non-coniferous trees
	Non-coniferous trees (scattered)		Coniferous trees
	Coniferous trees (scattered)		Positioned tree
	Orchard		Coppice or Osiers
	Rough Grassland		Heath
	Scrub		Marsh, Salt Marsh or Reeds
	Water feature		Flow arrows
	MHW(S) Mean high water (springs)		MLW(S) Mean low water (springs)
	Telephone line (where shown)		Electricity transmission line (with poles)
	Bench mark (where shown)		Triangulation station
	Point feature (e.g. Guide Post or Mile Stone)		Pylon, flare stack or lighting tower
	Site of (antiquity)		Glasshouse
	General Building		Important Building



Historical Mapping & Photography included:

Mapping Type	Scale	Date	Pg
Lincolnshire	1:10,560	1885	2
Lincolnshire	1:10,560	1907	3
Lincolnshire	1:10,560	1907	4
Lincolnshire	1:10,560	1947 - 1950	5
Ordnance Survey Plan	1:10,000	1956	6
Ordnance Survey Plan	1:10,000	1970	7
Ordnance Survey Plan	1:10,000	1980 - 1983	8
10K Raster Mapping	1:10,000	2000	9
Street View	Variable		10

Historical Map - Slice F

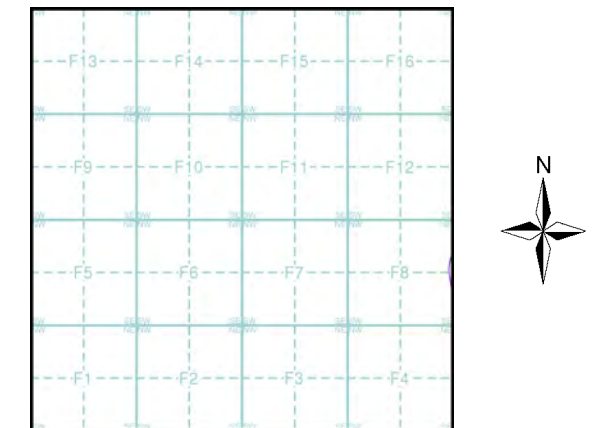

Order Details

Order Number: 297990273_1_1
 Customer Ref: 21-1088.04
 National Grid Reference: 488550, 390260
 Slice: F
 Site Area (Ha): 469.98
 Search Buffer (m): 250

Site Details

Cottam



Tel: [Redacted]
 Fax: [Redacted]
 Web: [Redacted]

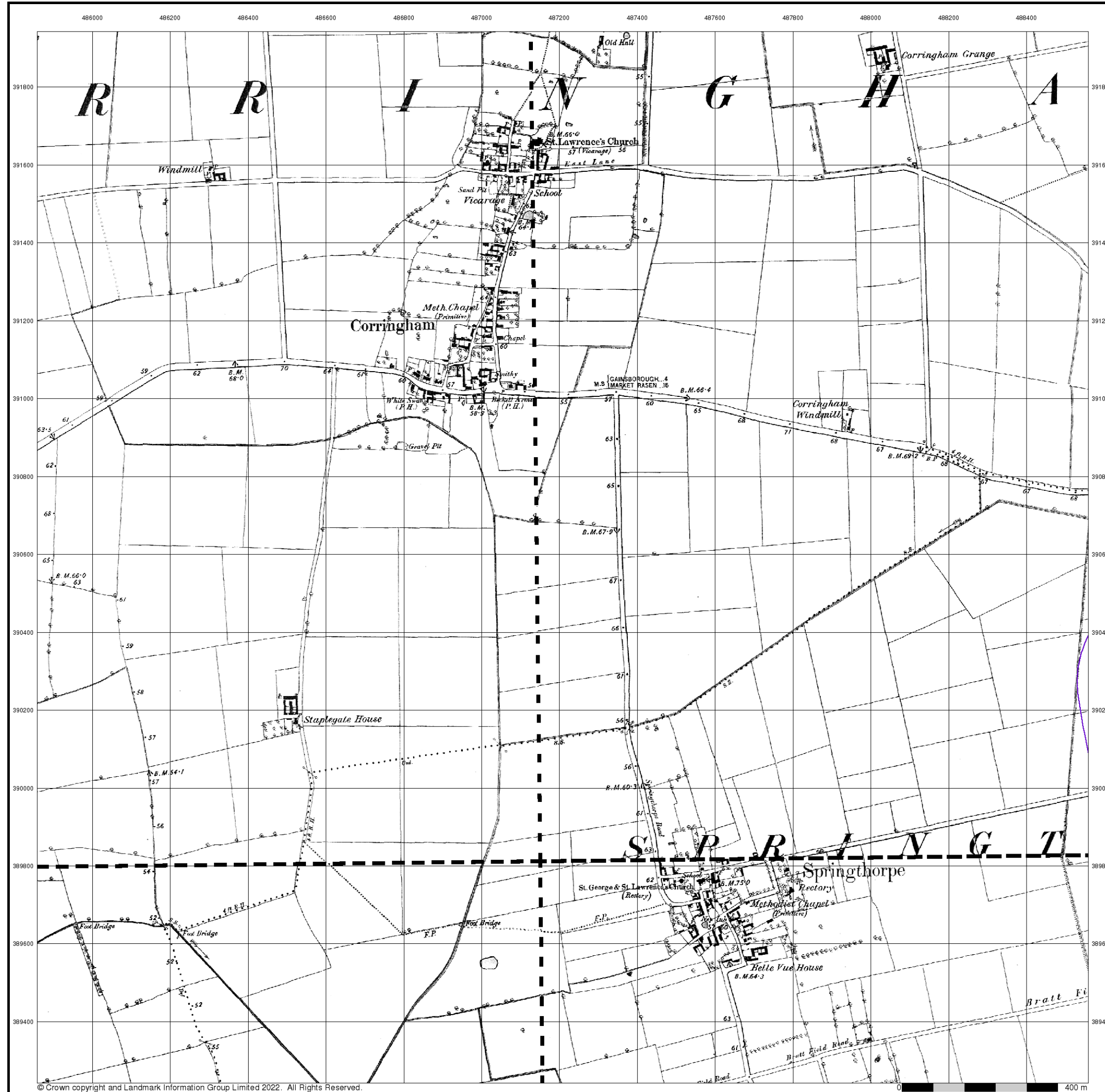

© Crown copyright and Landmark Information Group Limited 2022. All Rights Reserved.



Lincolnshire

Published 1885

Source map scale - 1:10,560

The historical maps shown were reproduced from maps predominantly held at the scale adopted for England, Wales and Scotland in the 1840's. In 1854 the 1:2,500 scale was adopted for mapping urban areas; these maps were used to update the 1:10,560 maps. The published date given therefore is often some years later than the surveyed date. Before 1938, all OS maps were based on the Cassini Projection, with independent surveys of a single county or group of counties, giving rise to significant inaccuracies in outlying areas. In the late 1940's, a Provisional Edition was produced, which updated the 1:10,560 mapping from a number of sources. The maps appear unfinished - with all military camps and other strategic sites removed. These maps were initially overprinted with the National Grid. In 1970, the first 1:10,000 maps were produced using the Transverse Mercator Projection. The revision process continued until recently, with new editions appearing every 10 years or so for urban areas.

Map Name(s) and Date(s)

043NW 1885 1:10,560	043NE 1885 1:10,560
043SW 1885 1:10,560	043SE 1885 1:10,560

Historical Map - Slice F

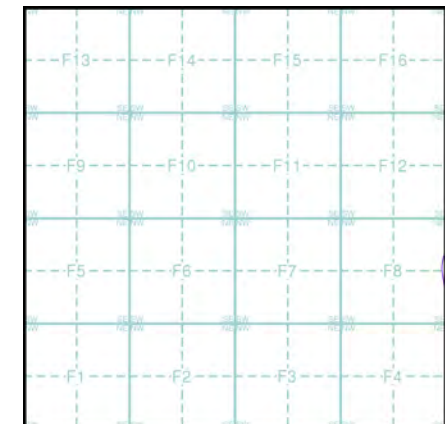

Order Details

Order Number: 297990273_1_1
 Customer Ref: 21-1088.04
 National Grid Reference: 488550, 390260
 Slice: F
 Site Area (Ha): 469.98
 Search Buffer (m): 250

Site Details

Cottam



Tel: [Redacted]
 Fax: [Redacted]
 Web: [Redacted]

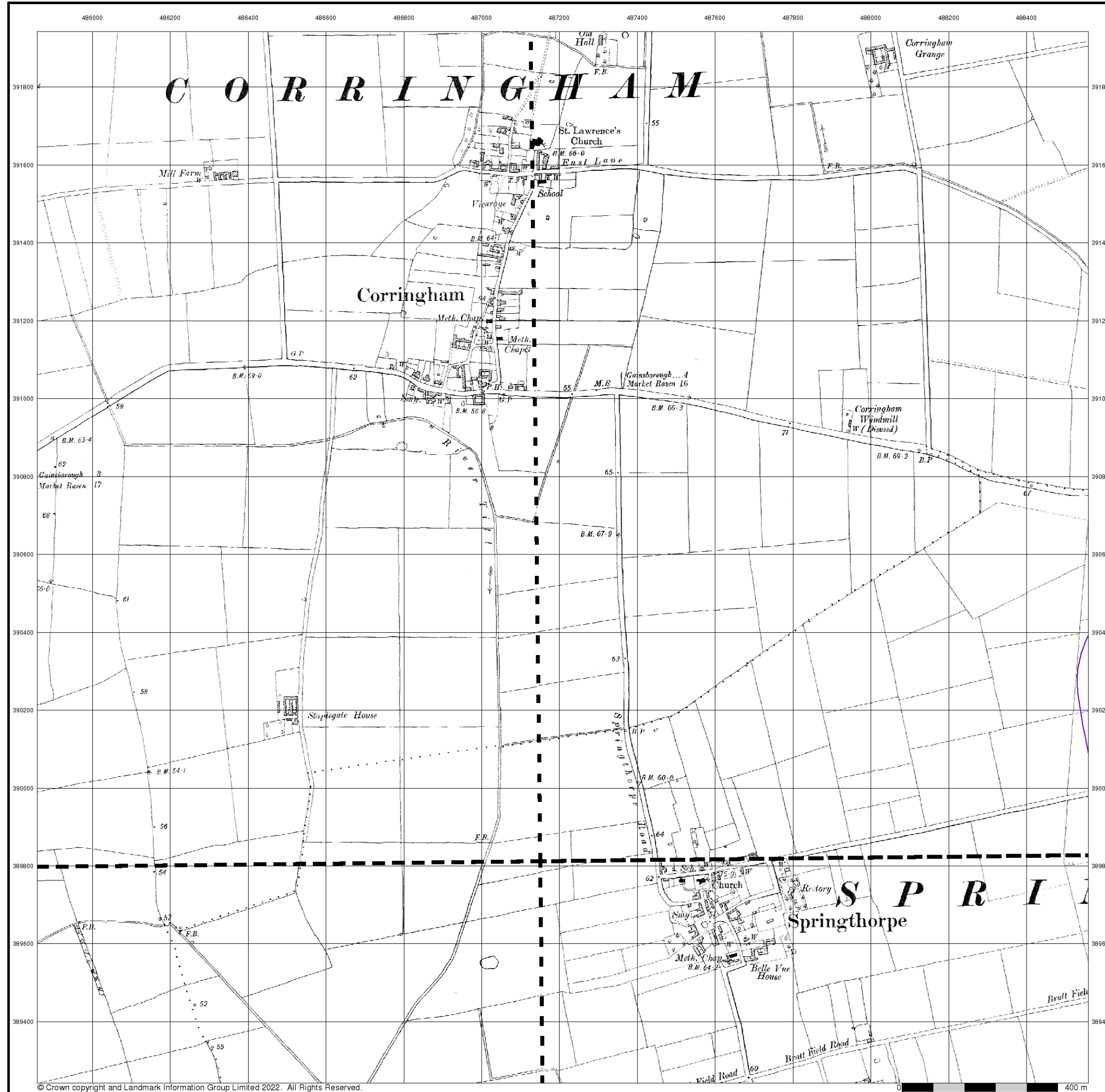

Lincolnshire

Published 1907

Source map scale - 1:10,560

The historical maps shown were reproduced from maps predominantly held at the scale adopted for England, Wales and Scotland in the 1840's. In 1854 the 1:2,500 scale was adopted for mapping urban areas; these maps were used to update the 1:10,560 maps. The published date given therefore is often some years later than the surveyed date. Before 1938, all OS maps were based on the Cassini Projection, with independent surveys of a single county or group of counties, giving rise to significant inaccuracies in outlying areas. In the late 1940's, a Provisional Edition was produced, which updated the 1:10,560 mapping from a number of sources. The maps appear unfinished - with all military camps and other strategic sites removed. These maps were initially overprinted with the National Grid. In 1970, the first 1:10,000 maps were produced using the Transverse Mercator Projection. The revision process continued until recently, with new editions appearing every 10 years or so for urban areas.

Map Name(s) and Date(s)

043NW 1907 1:10,560	043NE 1907 1:10,560
043SW 1907 1:10,560	043SE 1907 1:10,560

Historical Map - Slice F

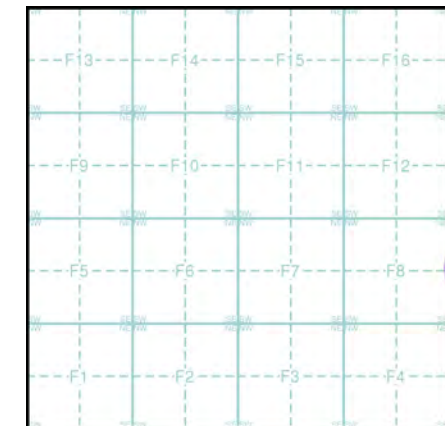

Order Details

Order Number: 297990273_1_1
 Customer Ref: 21-1088.04
 National Grid Reference: 488550, 390260
 Slice: F
 Site Area (Ha): 469.98
 Search Buffer (m): 250

Site Details

Cottam



Tel: [Redacted]
 Fax: [Redacted]
 Web: [Redacted]

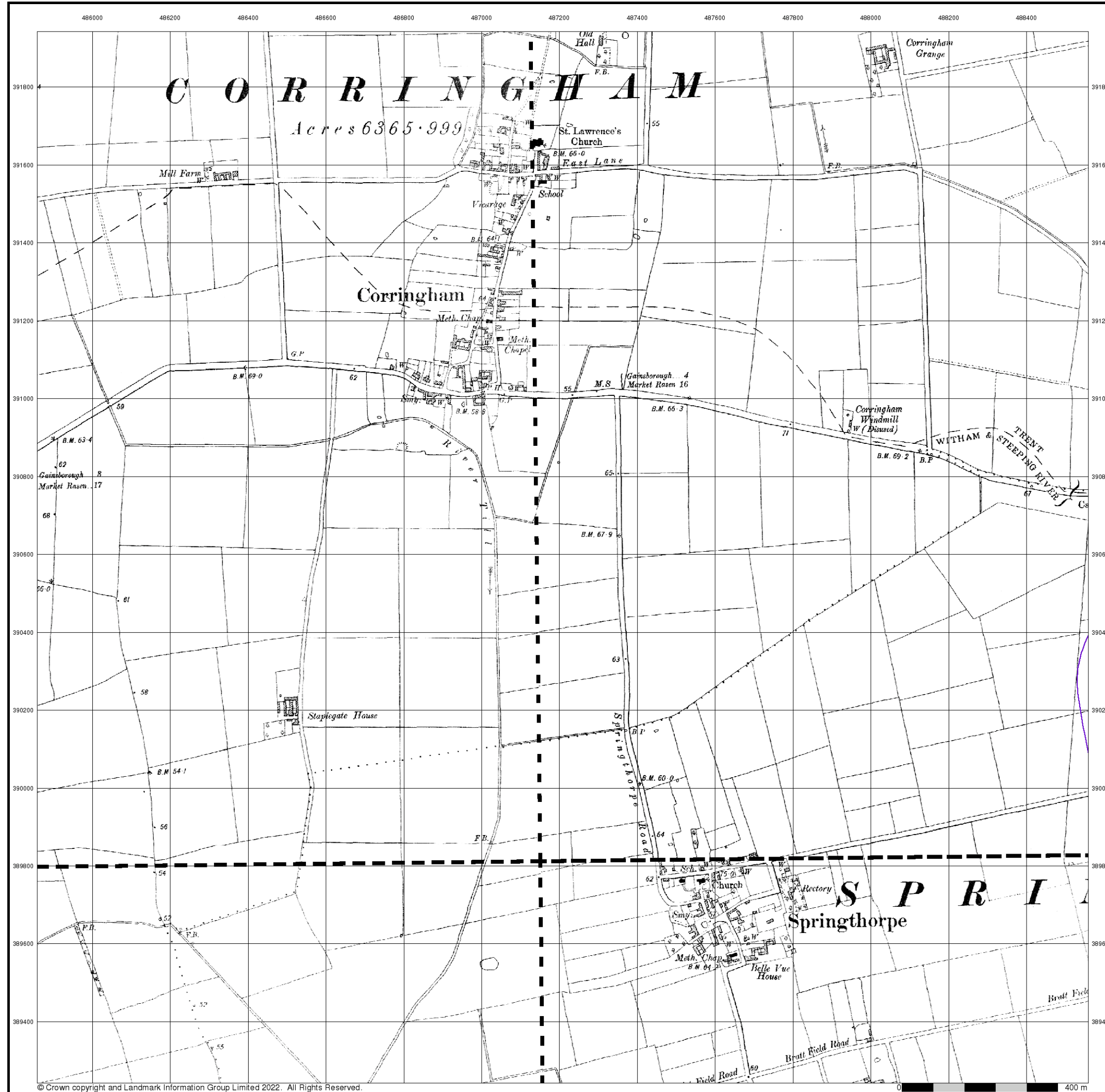

Lincolnshire

Published 1907

Source map scale - 1:10,560

The historical maps shown were reproduced from maps predominantly held at the scale adopted for England, Wales and Scotland in the 1840's. In 1854 the 1:2,500 scale was adopted for mapping urban areas; these maps were used to update the 1:10,560 maps. The published date given therefore is often some years later than the surveyed date. Before 1938, all OS maps were based on the Cassini Projection, with independent surveys of a single county or group of counties, giving rise to significant inaccuracies in outlying areas. In the late 1940's, a Provisional Edition was produced, which updated the 1:10,560 mapping from a number of sources. The maps appear unfinished - with all military camps and other strategic sites removed. These maps were initially overprinted with the National Grid. In 1970, the first 1:10,000 maps were produced using the Transverse Mercator Projection. The revision process continued until recently, with new editions appearing every 10 years or so for urban areas.

Map Name(s) and Date(s)

043NW 1907 1:10,560	043NE 1907 1:10,560
043SW 1907 1:10,560	043SE 1907 1:10,560

Historical Map - Slice F

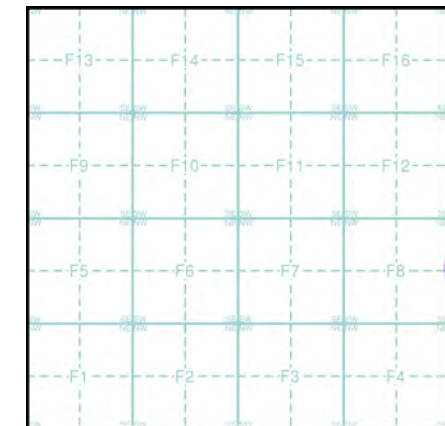

Order Details

Order Number: 297990273_1_1
 Customer Ref: 21-1088.04
 National Grid Reference: 488550, 390260
 Slice: F
 Site Area (Ha): 469.98
 Search Buffer (m): 250

Site Details

Cottam



Tel: [Redacted]
 Fax: [Redacted]
 Web: [Redacted]

Lincolnshire

Published 1947 - 1950

Source map scale - 1:10,560

The historical maps shown were reproduced from maps predominantly held at the scale adopted for England, Wales and Scotland in the 1840's. In 1854 the 1:2,500 scale was adopted for mapping urban areas; these maps were used to update the 1:10,560 maps. The published date given therefore is often some years later than the surveyed date. Before 1938, all OS maps were based on the Cassini Projection, with independent surveys of a single county or group of counties, giving rise to significant inaccuracies in outlying areas. In the late 1940's, a Provisional Edition was produced, which updated the 1:10,560 mapping from a number of sources. The maps appear unfinished - with all military camps and other strategic sites removed. These maps were initially overprinted with the National Grid. In 1970, the first 1:10,000 maps were produced using the Transverse Mercator Projection. The revision process continued until recently, with new editions appearing every 10 years or so for urban areas.

Map Name(s) and Date(s)

043NW 1948 1:10,560	043NE 1948 1:10,560
043SW 1950 1:10,560	043SE 1947 1:10,560

Historical Map - Slice F

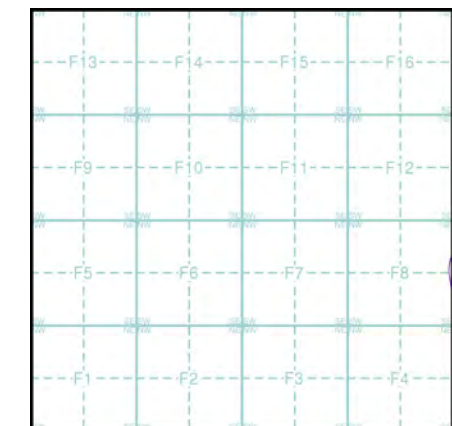

Order Details

Order Number: 297990273_1_1
 Customer Ref: 21-1088.04
 National Grid Reference: 488550, 390260
 Slice: F
 Site Area (Ha): 469.98
 Search Buffer (m): 250

Site Details

Cottam

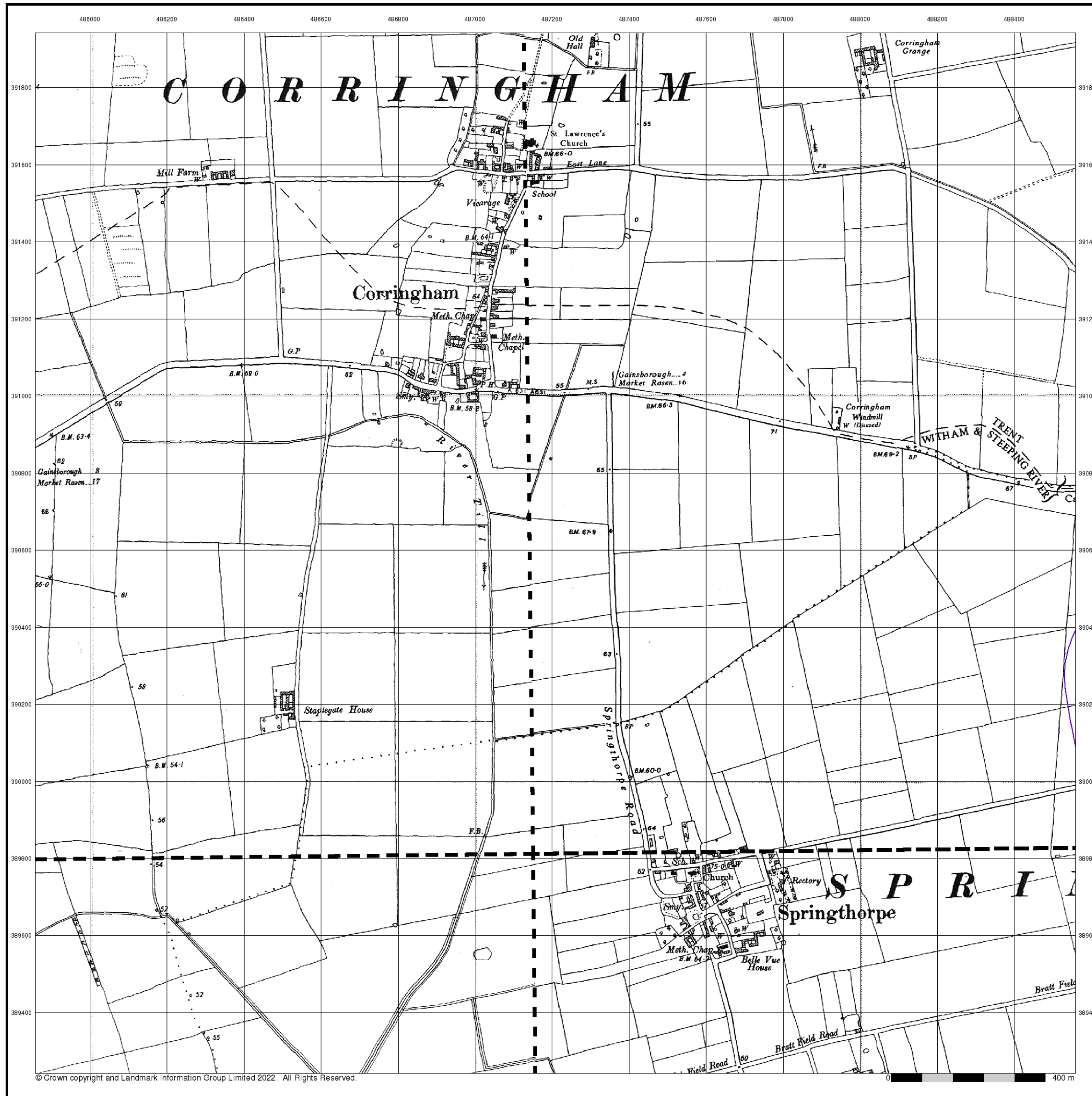

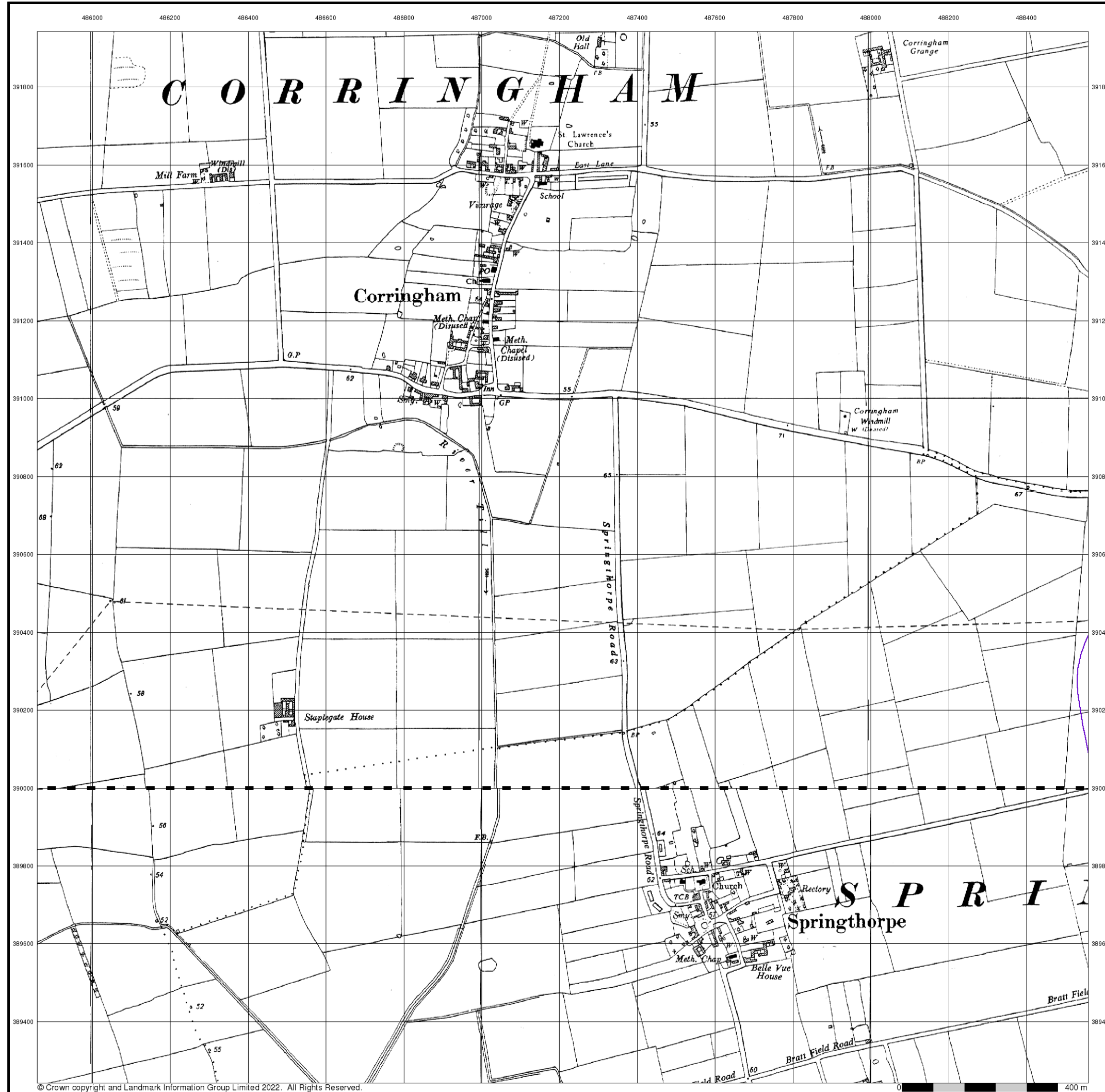

Ordnance Survey Plan

Published 1956

Source map scale - 1:10,000

The historical maps shown were reproduced from maps predominantly held at the scale adopted for England, Wales and Scotland in the 1840's. In 1854 the 1:2,500 scale was adopted for mapping urban areas; these maps were used to update the 1:10,560 maps. The published date given therefore is often some years later than the surveyed date. Before 1938, all OS maps were based on the Cassini Projection, with independent surveys of a single county or group of counties, giving rise to significant inaccuracies in outlying areas. In the late 1940's, a Provisional Edition was produced, which updated the 1:10,560 mapping from a number of sources. The maps appear unfinished - with all military camps and other strategic sites removed. These maps were initially overprinted with the National Grid. In 1970, the first 1:10,000 maps were produced using the Transverse Mercator Projection. The revision process continued until recently, with new editions appearing every 10 years or so for urban areas.

Map Name(s) and Date(s)

SK89SE	1956
1:10,560	
SK88NE	1956
1:10,560	

Historical Map - Slice F

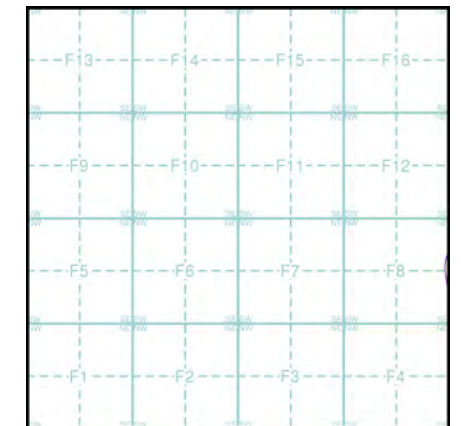

Order Details

Order Number: 297990273_1_1
 Customer Ref: 21-1088.04
 National Grid Reference: 488550, 390260
 Slice: F
 Site Area (Ha): 469.98
 Search Buffer (m): 250

Site Details

Cottam



Tel: [Redacted]
 Fax: [Redacted]
 Web: [Redacted]

Ordnance Survey Plan

Published 1970

Source map scale - 1:10,000

The historical maps shown were reproduced from maps predominantly held at the scale adopted for England, Wales and Scotland in the 1840's. In 1854 the 1:2,500 scale was adopted for mapping urban areas; these maps were used to update the 1:10,560 maps. The published date given therefore is often some years later than the surveyed date. Before 1938, all OS maps were based on the Cassini Projection, with independent surveys of a single county or group of counties, giving rise to significant inaccuracies in outlying areas. In the late 1940's, a Provisional Edition was produced, which updated the 1:10,560 mapping from a number of sources. The maps appear unfinished - with all military camps and other strategic sites removed. These maps were initially overprinted with the National Grid. In 1970, the first 1:10,000 maps were produced using the Transverse Mercator Projection. The revision process continued until recently, with new editions appearing every 10 years or so for urban areas.

Map Name(s) and Date(s)

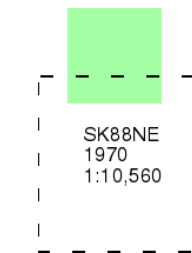

Historical Map - Slice F

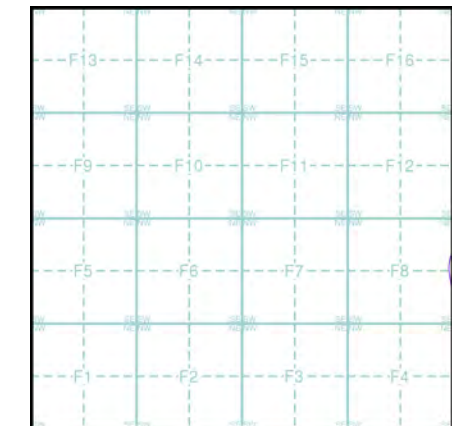

Order Details

Order Number: 297990273_1_1
 Customer Ref: 21-1088.04
 National Grid Reference: 488550, 390260
 Slice: F
 Site Area (Ha): 469.98
 Search Buffer (m): 250

Site Details

Cottam

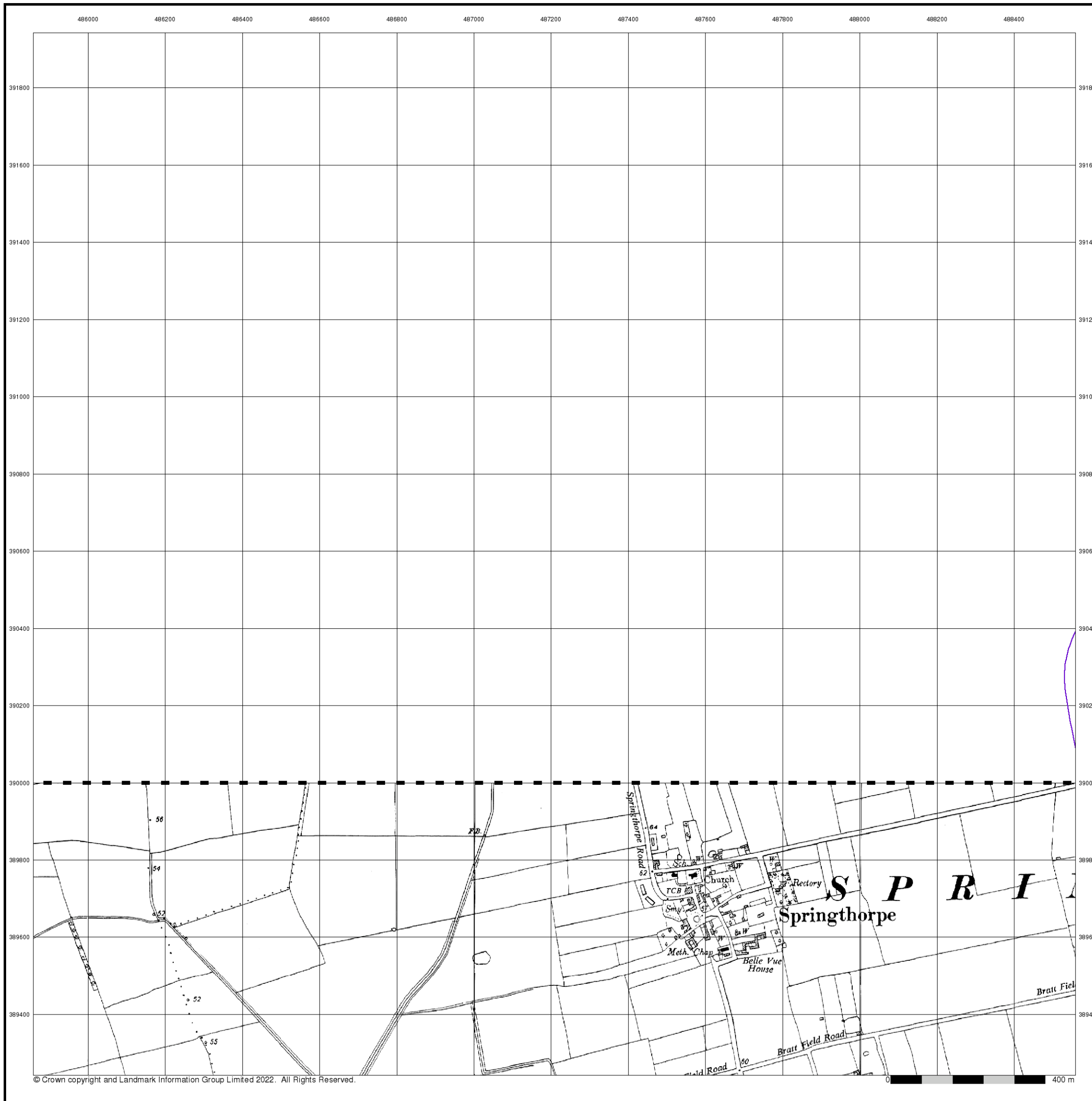

Ordnance Survey Plan

Published 1980 - 1983

Source map scale - 1:10,000

The historical maps shown were reproduced from maps predominantly held at the scale adopted for England, Wales and Scotland in the 1840's. In 1854 the 1:2,500 scale was adopted for mapping urban areas; these maps were used to update the 1:10,560 maps. The published date given therefore is often some years later than the surveyed date. Before 1938, all OS maps were based on the Cassini Projection, with independent surveys of a single county or group of counties, giving rise to significant inaccuracies in outlying areas. In the late 1940's, a Provisional Edition was produced, which updated the 1:10,560 mapping from a number of sources. The maps appear unfinished - with all military camps and other strategic sites removed. These maps were initially overprinted with the National Grid. In 1970, the first 1:10,000 maps were produced using the Transverse Mercator Projection. The revision process continued until recently, with new editions appearing every 10 years or so for urban areas.

Map Name(s) and Date(s)

SK89SE	1983	1:10,000
SK88NE	1980	1:10,000

Historical Map - Slice F

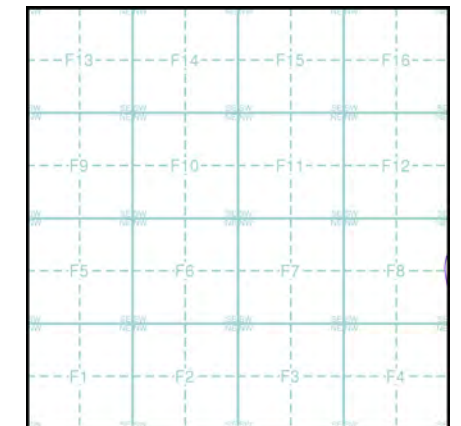

Order Details

Order Number: 297990273_1_1
 Customer Ref: 21-1088.04
 National Grid Reference: 488550, 390260
 Slice: F
 Site Area (Ha): 469.98
 Search Buffer (m): 250

Site Details

Cottam

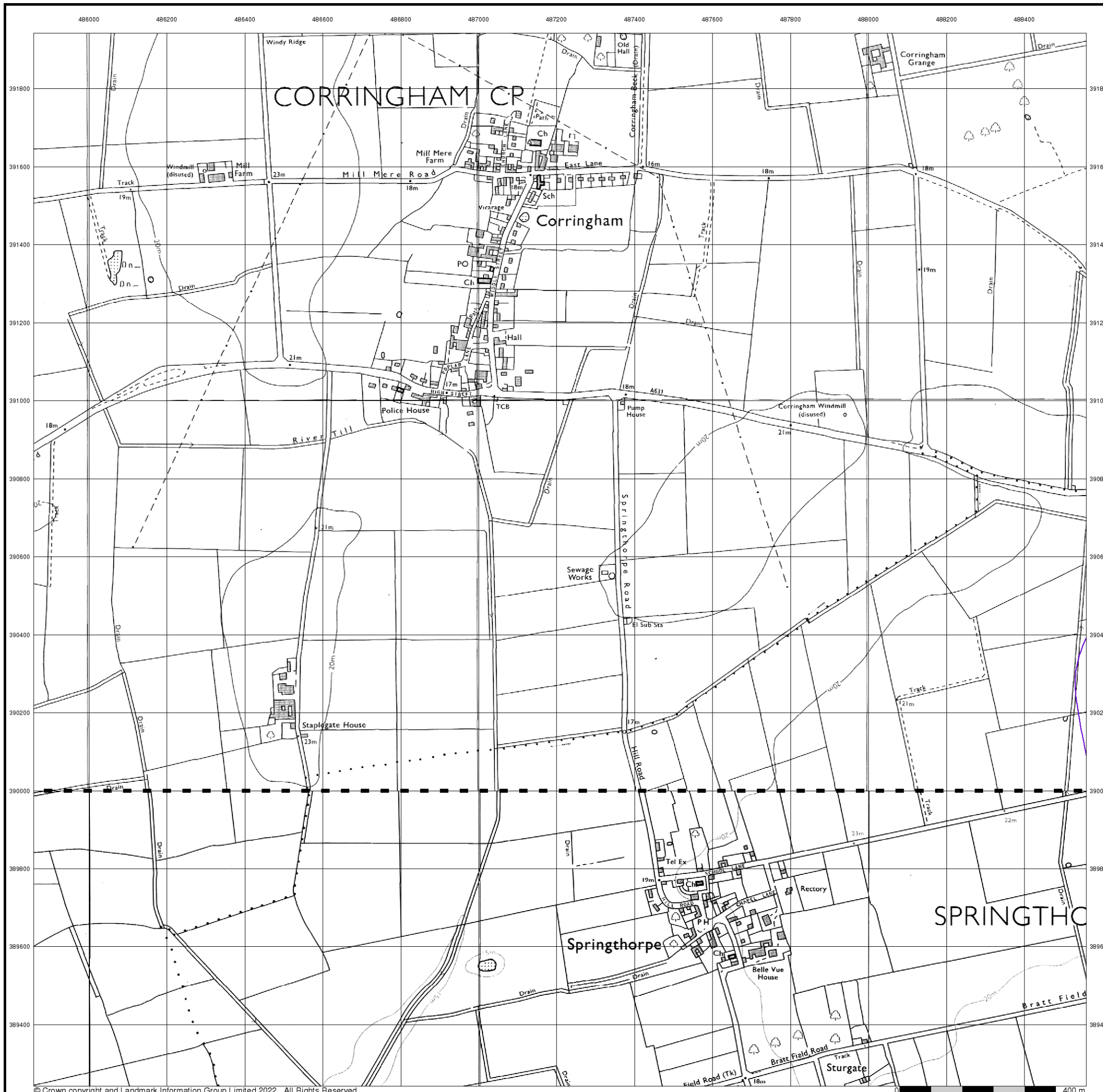

10k Raster Mapping

Published 2000

Source map scale - 1:10,000

The historical maps shown were produced from the Ordnance Survey's 1:10,000 colour raster mapping. These maps are derived from Landplan which replaced the old 1:10,000 maps originally published in 1970. The data is highly detailed showing buildings, fences and field boundaries as well as all roads, tracks and paths. Road names are also included together with the relevant road number and classification. Boundary information depiction includes county, unitary authority, district, civil parish and constituency.

Map Name(s) and Date(s)

SK89SE	2000	1:10,000
SK88NE	2000	1:10,000

Historical Map - Slice F

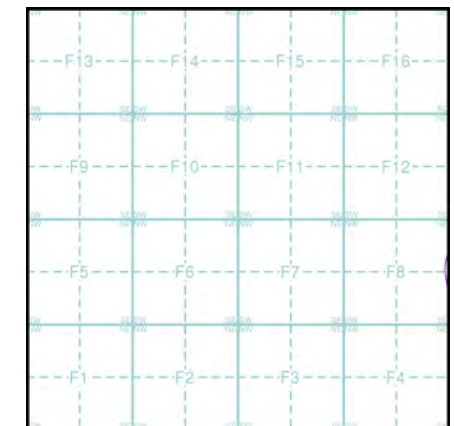

Order Details

Order Number: 297990273_1_1
 Customer Ref: 21-1088.04
 National Grid Reference: 488550, 390260
 Slice: F
 Site Area (Ha): 469.98
 Search Buffer (m): 250

Site Details

Cottam

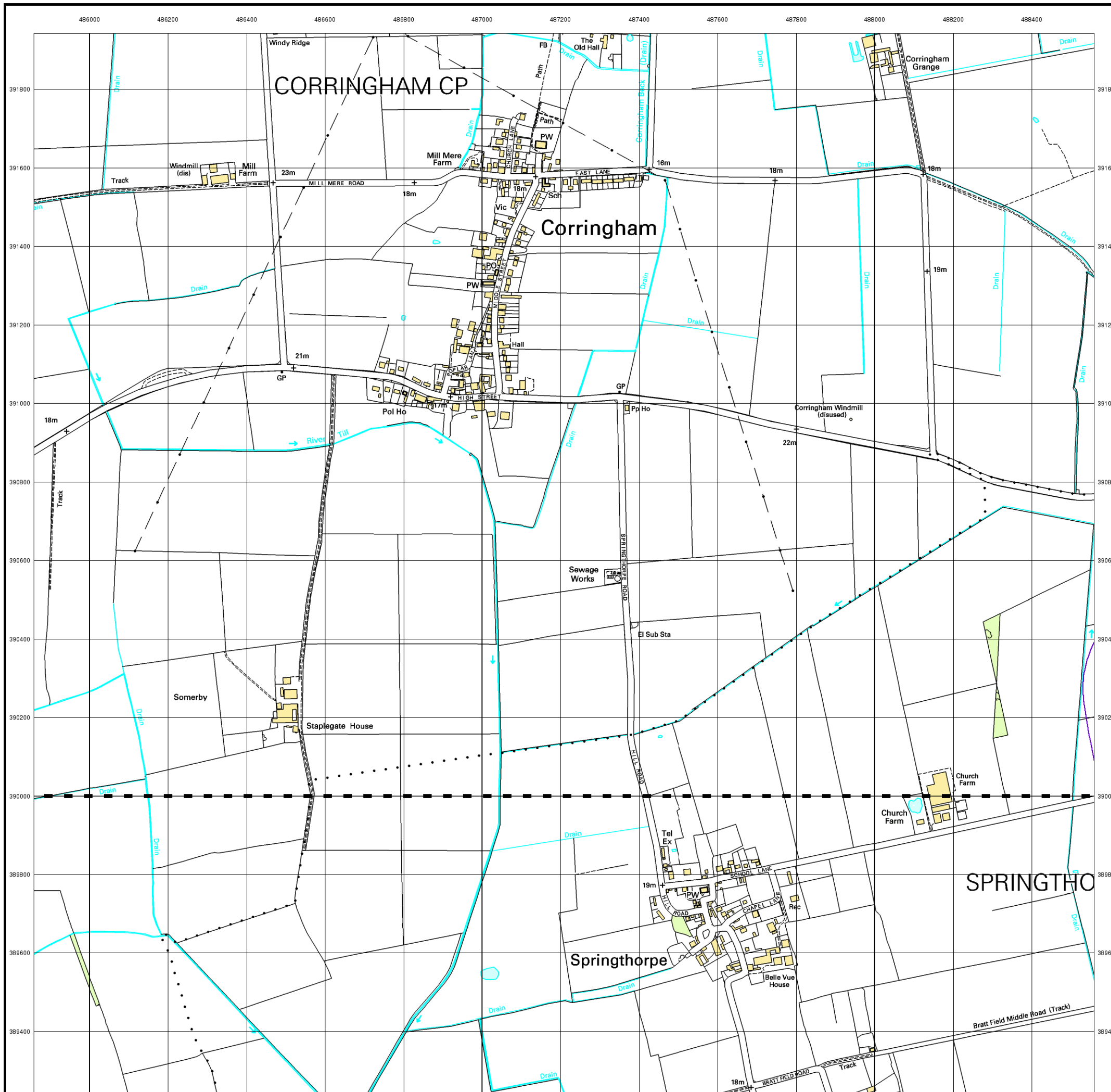

Street View

Published 2022

Source map scale - 1:10,000

Street View is a street-level map for the whole of Great Britain produced by the Ordnance Survey. These maps are provided at a nominal scale of 1:10,000

Map Name(s) and Date(s)



Street View Map - Slice F

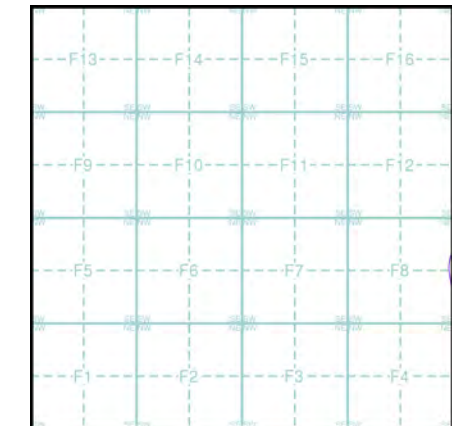

Order Details

Order Number: 297990273_1_1
 Customer Ref: 21-1088.04
 National Grid Reference: 488550, 390260
 Slice: F
 Site Area (Ha): 469.98
 Search Buffer (m): 250

Site Details

Cottam

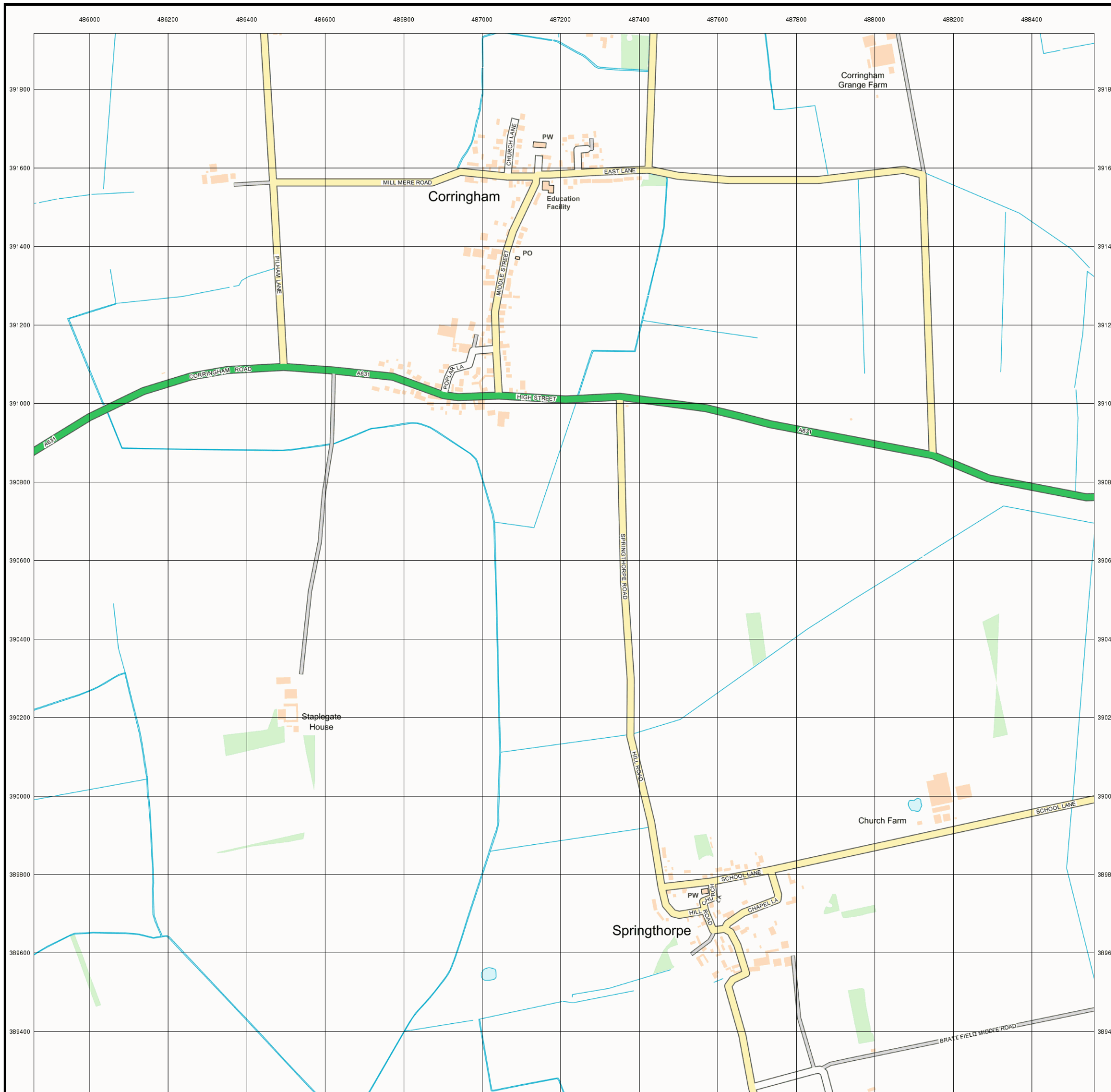

Historical Mapping Legends

Ordnance Survey County Series 1:10,560

- Gravel Pit
- Sand Pit
- Other Pits
- Quarry
- Shingle
- Orchard
- Osiers
- Reeds
- Marsh
- Mixed Wood
- Deciduous
- Brushwood
- Fir
- Furze
- Rough Pasture
- Arrow denotes flow of water
- Trigonometrical Station
- Site of Antiquities
- Bench Mark
- Pump, Guide Post, Signal Post
- Well, Spring, Boundary Post
- 285** Surface Level
- Sketched Contour
- Instrumental Contour
- Main Roads
- Minor Roads
- Sunken Road
- Raised Road
- Road over Railway
- Railway over River
- Railway over Road
- Level Crossing
- Road over River or Canal
- Road over Stream
- Road over Stream
- County Boundary (Geographical)
- County & Civil Parish Boundary
- Administrative County & Civil Parish Boundary
- County Borough Boundary (England)
- County Burgh Boundary (Scotland)
- Rural District Boundary
- Civil Parish Boundary

Ordnance Survey Plan 1:10,000

- Chalk Pit, Clay Pit or Quarry
- Gravel Pit
- Sand Pit
- Disused Pit or Quarry
- Refuse or Slag Heap
- Lake, Loch or Pond
- Dunes
- Boulders
- Coniferous Trees
- Non-Coniferous Trees
- Orchard
- Scrub
- Coppice
- Bracken
- Heath
- Rough Grassland
- Marsh
- Reeds
- Saltings
- Building
- Glasshouse
- Sloping Masonry
- Pylon
- Electricity Transmission Line
- Pole
- Cutting
- Embankment
- Standard Gauge Multiple Track
- Standard Gauge Single Track
- Siding, Tramway or Mineral Line
- Narrow Gauge
- Geographical County
- Administrative County, County Borough or County of City
- Municipal Borough, Urban or Rural District, Burgh or District Council
- Borough, Burgh or County Constituency
Shown only when not coincident with other boundaries
- Civil Parish
Shown alternately when coincidence of boundaries occurs
- BP, BS Boundary Post or Stone
- Ch Church
- CH Club House
- F E Sta Fire Engine Station
- FB Foot Bridge
- Fn Fountain
- GP Guide Post
- MP Mile Post
- MS Mile Stone
- Pol Sta Police Station
- PO Post Office
- PC Public Convenience
- PH Public House
- SB Signal Box
- Spr Spring
- TCB Telephone Call Box
- TCP Telephone Call Post
- W Well

1:10,000 Raster Mapping

- Gravel Pit
- Rock
- Boulders
- Shingle
- Sand
- Slopes
- General detail
- Overhead detail
- Multi-track railway
- County boundary (England only)
- District, Unitary, Metropolitan, London Borough boundary
- Area of wooded vegetation
- Non-coniferous trees (scattered)
- Coniferous trees (scattered)
- Orchard
- Rough Grassland
- Scrub
- Water feature
- MHW(S) Mean high water (springs)
- Bench mark (where shown)
- Point feature (e.g. Guide Post or Mile Stone)
- Site of (antiquity)
- General Building
- Refuse tip or slag heap
- Rock (scattered)
- Boulders (scattered)
- Mud
- Sand Pit
- Top of cliff
- Underground detail
- Narrow gauge railway
- Single track railway
- Civil, parish or community boundary
- Constituency boundary
- Non-coniferous trees
- Coniferous trees
- Positioned tree
- Coppice or Osiers
- Heath
- Marsh, Salt Marsh or Reeds
- Flow arrows
- MLW(S) Mean low water (springs)
- Triangulation station
- Pylon, flare stack or lighting tower
- Glasshouse
- Important Building



Historical Mapping & Photography included:

Mapping Type	Scale	Date	Pg
Lincolnshire	1:10,560	1885	2
Lincolnshire	1:10,560	1907	3
Lincolnshire	1:10,560	1907	4
Lincolnshire	1:10,560	1947 - 1948	5
Ordnance Survey Plan	1:10,000	1956	6
Ordnance Survey Plan	1:10,000	1970 - 1979	7
Ordnance Survey Plan	1:10,000	1980 - 1983	8
10K Raster Mapping	1:10,000	2000	9
Street View	Variable		10

Historical Map - Slice G

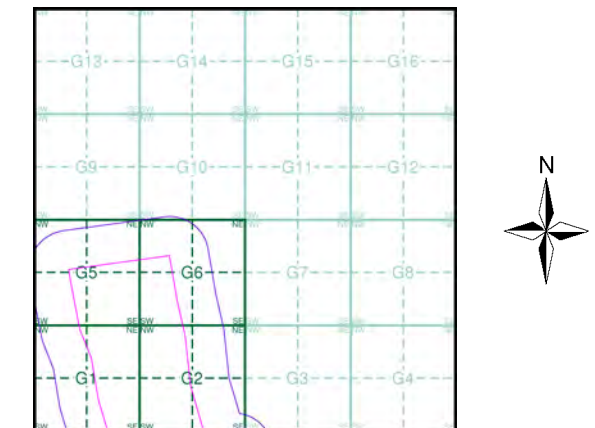

Order Details

Order Number: 297990273_1_1
 Customer Ref: 21-1088.04
 National Grid Reference: 489210, 389890
 Slice: G
 Site Area (Ha): 469.98
 Search Buffer (m): 250

Site Details

Cottam



Tel: [Redacted]
 Fax: [Redacted]
 Web: [Redacted]

Lincolnshire

Published 1885

Source map scale - 1:10,560

The historical maps shown were reproduced from maps predominantly held at the scale adopted for England, Wales and Scotland in the 1840's. In 1854 the 1:2,500 scale was adopted for mapping urban areas; these maps were used to update the 1:10,560 maps. The published date given therefore is often some years later than the surveyed date. Before 1938, all OS maps were based on the Cassini Projection, with independent surveys of a single county or group of counties, giving rise to significant inaccuracies in outlying areas. In the late 1940's, a Provisional Edition was produced, which updated the 1:10,560 mapping from a number of sources. The maps appear unfinished - with all military camps and other strategic sites removed. These maps were initially overprinted with the National Grid. In 1970, the first 1:10,000 maps were produced using the Transverse Mercator Projection. The revision process continued until recently, with new editions appearing every 10 years or so for urban areas.

Map Name(s) and Date(s)

043NE	1885	1:10,560
043SE	1885	1:10,560

Historical Map - Slice G

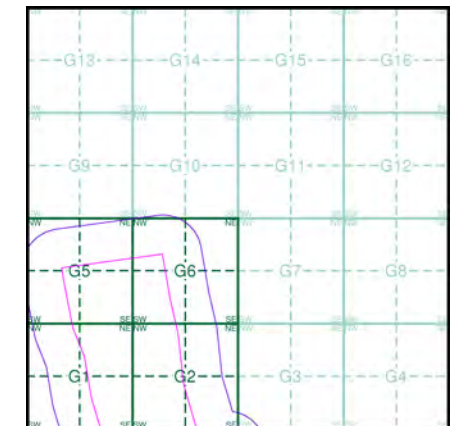

Order Details

Order Number: 297990273_1_1
 Customer Ref: 21-1088.04
 National Grid Reference: 489210, 389890
 Slice: G
 Site Area (Ha): 469.98
 Search Buffer (m): 250

Site Details

Cottam

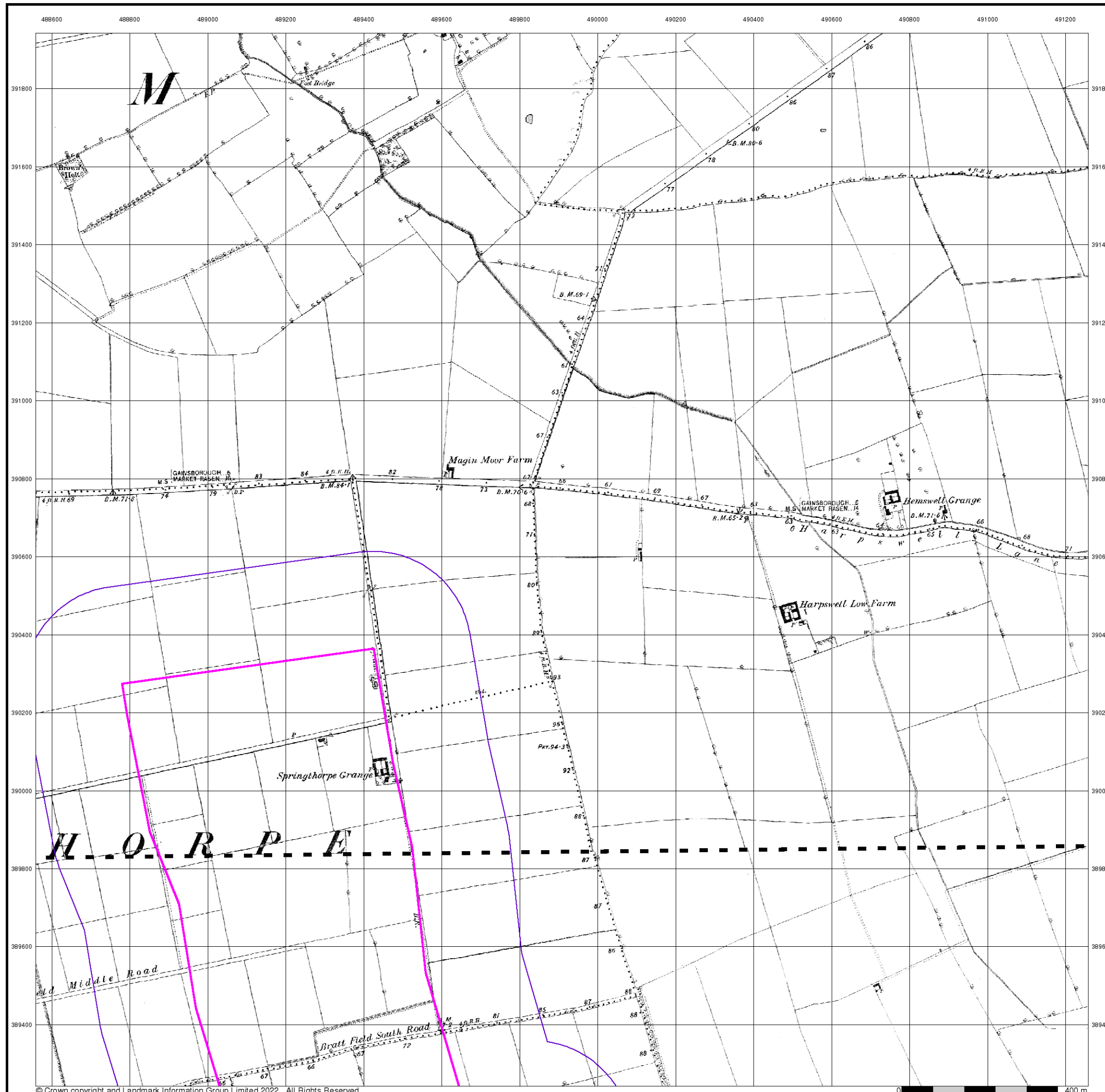

Lincolnshire

Published 1907

Source map scale - 1:10,560

The historical maps shown were reproduced from maps predominantly held at the scale adopted for England, Wales and Scotland in the 1840's. In 1854 the 1:2,500 scale was adopted for mapping urban areas; these maps were used to update the 1:10,560 maps. The published date given therefore is often some years later than the surveyed date. Before 1938, all OS maps were based on the Cassini Projection, with independent surveys of a single county or group of counties, giving rise to significant inaccuracies in outlying areas. In the late 1940's, a Provisional Edition was produced, which updated the 1:10,560 mapping from a number of sources. The maps appear unfinished - with all military camps and other strategic sites removed. These maps were initially overprinted with the National Grid. In 1970, the first 1:10,000 maps were produced using the Transverse Mercator Projection. The revision process continued until recently, with new editions appearing every 10 years or so for urban areas.

Map Name(s) and Date(s)

043NE	1907	1:10,560
043SE	1907	1:10,560

Historical Map - Slice G

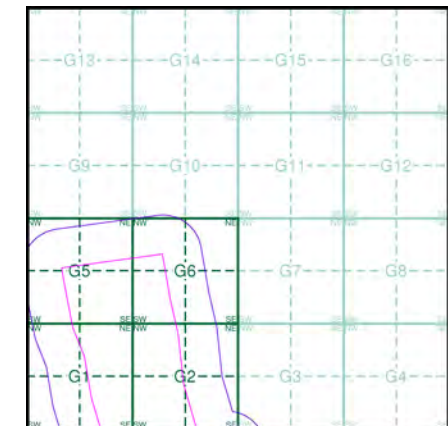

Order Details

Order Number: 297990273_1_1
 Customer Ref: 21-1088.04
 National Grid Reference: 489210, 389890
 Slice: G
 Site Area (Ha): 469.98
 Search Buffer (m): 250

Site Details

Cottam

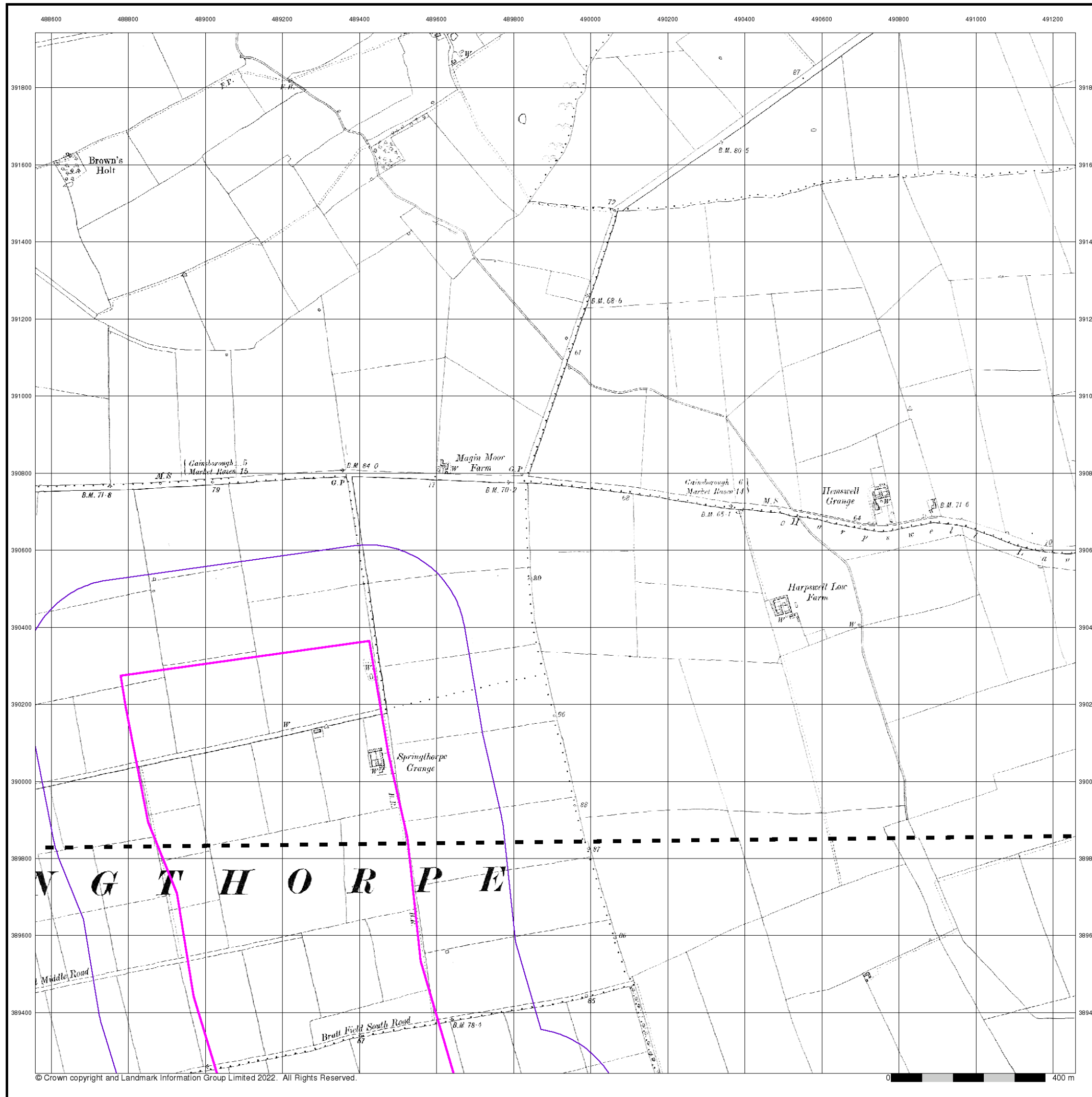

Lincolnshire

Published 1907

Source map scale - 1:10,560

The historical maps shown were reproduced from maps predominantly held at the scale adopted for England, Wales and Scotland in the 1840's. In 1854 the 1:2,500 scale was adopted for mapping urban areas; these maps were used to update the 1:10,560 maps. The published date given therefore is often some years later than the surveyed date. Before 1938, all OS maps were based on the Cassini Projection, with independent surveys of a single county or group of counties, giving rise to significant inaccuracies in outlying areas. In the late 1940's, a Provisional Edition was produced, which updated the 1:10,560 mapping from a number of sources. The maps appear unfinished - with all military camps and other strategic sites removed. These maps were initially overprinted with the National Grid. In 1970, the first 1:10,000 maps were produced using the Transverse Mercator Projection. The revision process continued until recently, with new editions appearing every 10 years or so for urban areas.

Map Name(s) and Date(s)

043NE	1907	1:10,560
043SE	1907	1:10,560

Historical Map - Slice G

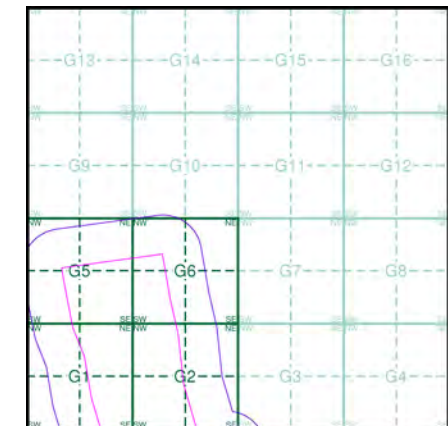

Order Details

Order Number: 297990273_1_1
 Customer Ref: 21-1088.04
 National Grid Reference: 489210, 389890
 Slice: G
 Site Area (Ha): 469.98
 Search Buffer (m): 250

Site Details

Cottam

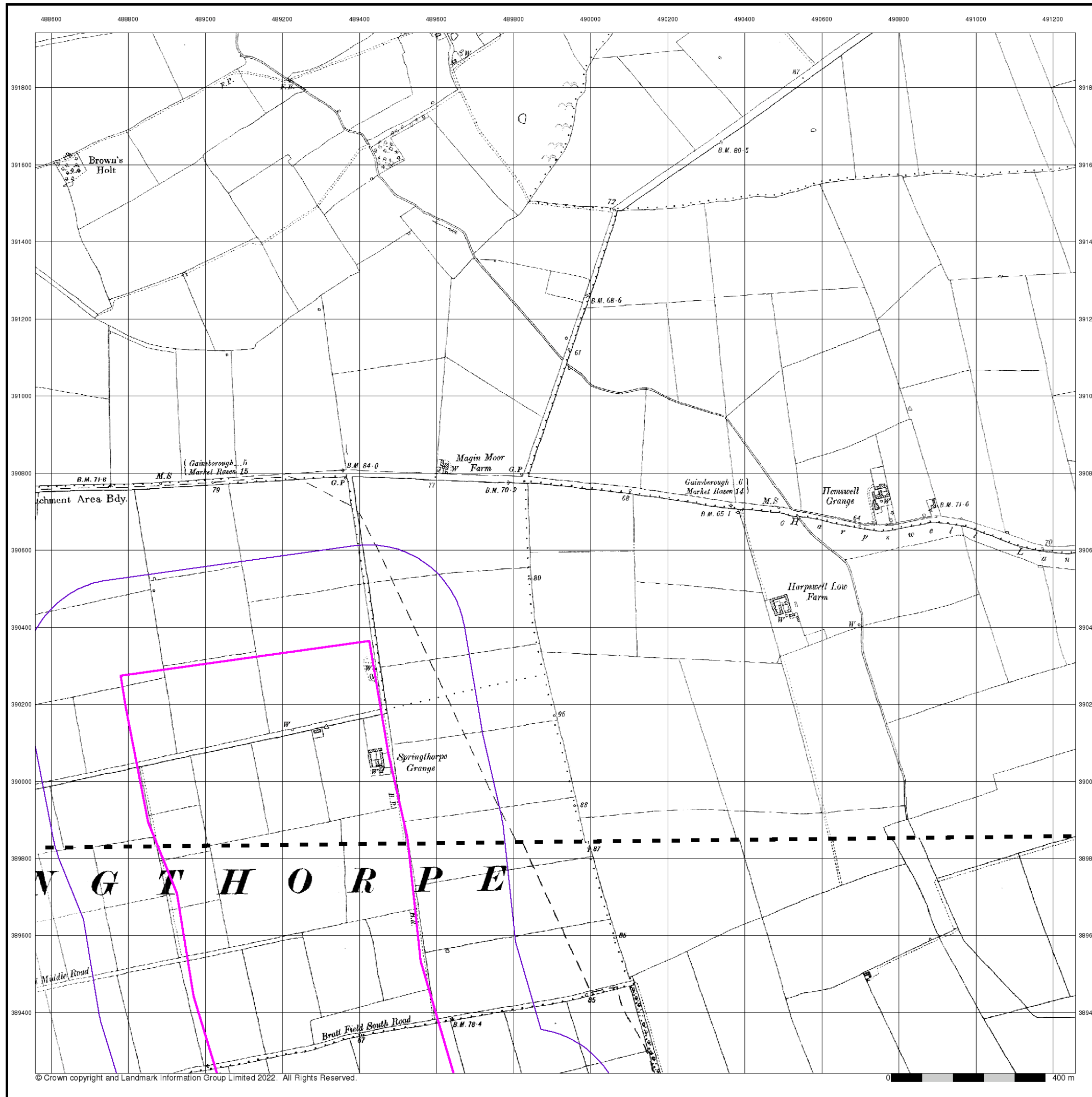

Lincolnshire

Published 1947 - 1948

Source map scale - 1:10,560

The historical maps shown were reproduced from maps predominantly held at the scale adopted for England, Wales and Scotland in the 1840's. In 1854 the 1:2,500 scale was adopted for mapping urban areas; these maps were used to update the 1:10,560 maps. The published date given therefore is often some years later than the surveyed date. Before 1938, all OS maps were based on the Cassini Projection, with independent surveys of a single county or group of counties, giving rise to significant inaccuracies in outlying areas. In the late 1940's, a Provisional Edition was produced, which updated the 1:10,560 mapping from a number of sources. The maps appear unfinished - with all military camps and other strategic sites removed. These maps were initially overprinted with the National Grid. In 1970, the first 1:10,000 maps were produced using the Transverse Mercator Projection. The revision process continued until recently, with new editions appearing every 10 years or so for urban areas.

Map Name(s) and Date(s)

043NE	1948	1:10,560
043SE	1947	1:10,560

Historical Map - Slice G

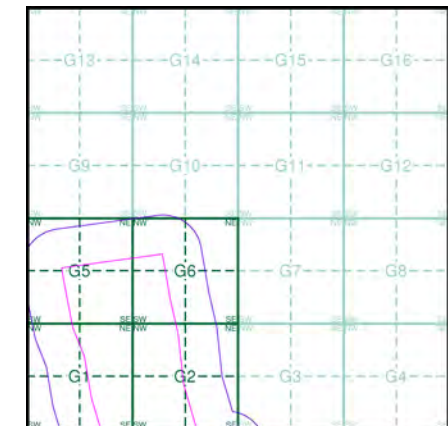

Order Details

Order Number: 297990273_1_1
 Customer Ref: 21-1088.04
 National Grid Reference: 489210, 389890
 Slice: G
 Site Area (Ha): 469.98
 Search Buffer (m): 250

Site Details

Cottam

